

LOCALE	CODICE	DESCRIZIONE COMPONENTE	FINITURA	GR.
CABINA OSPITI DX	MD321_R01_RA01	SPECCHIERA TV	LAISTRA ALPI JAY STRIPED 12.35	2

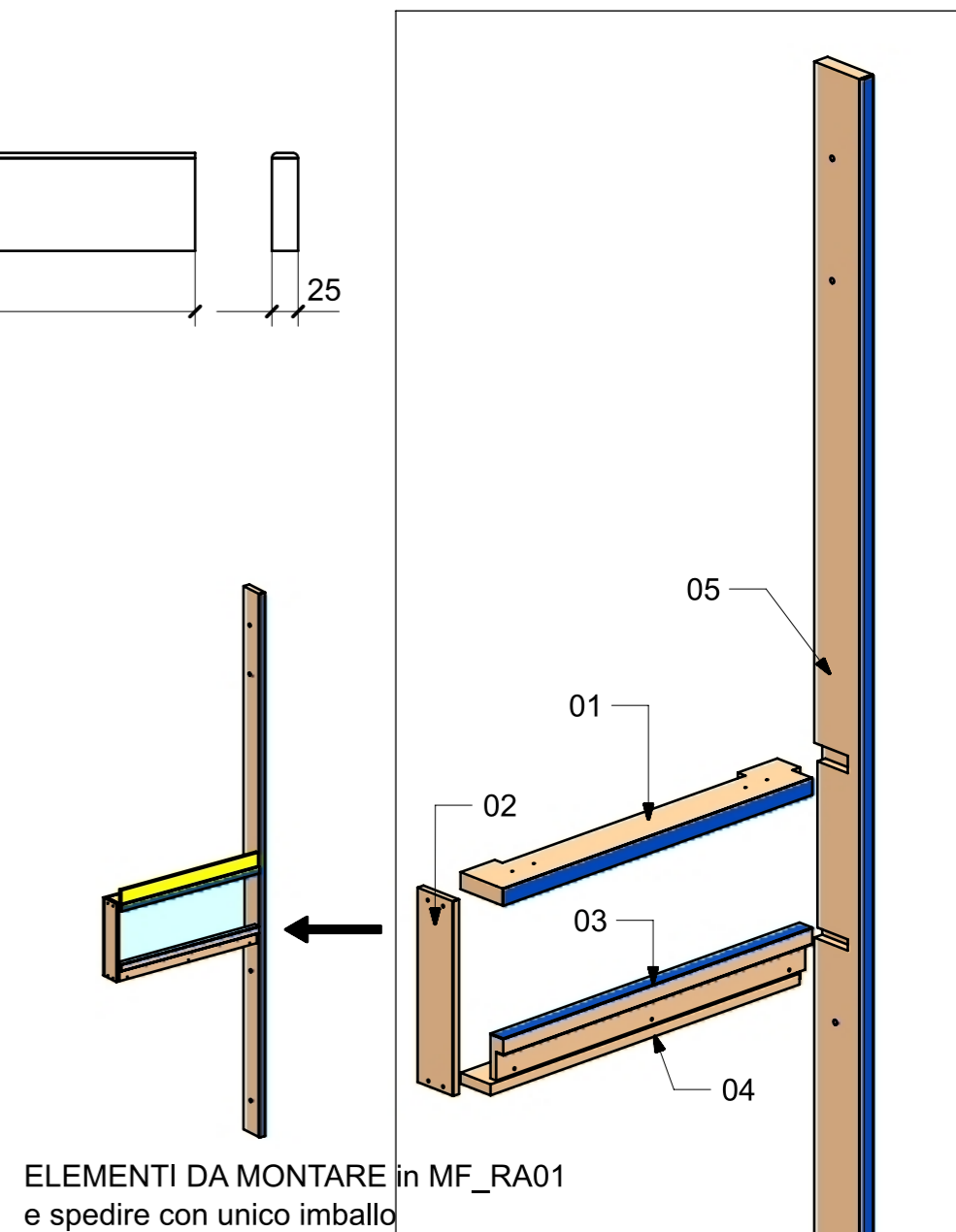
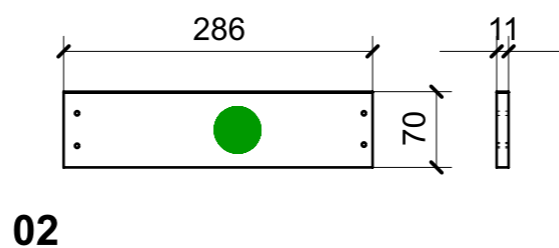
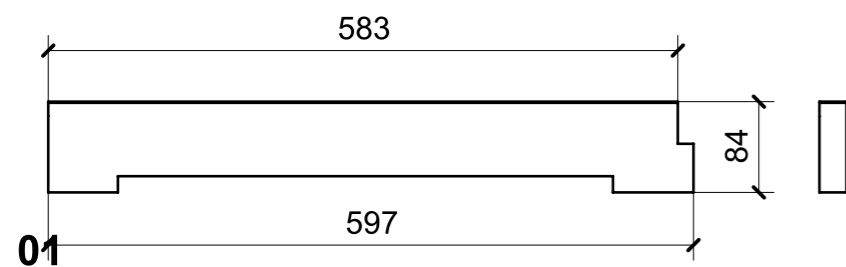
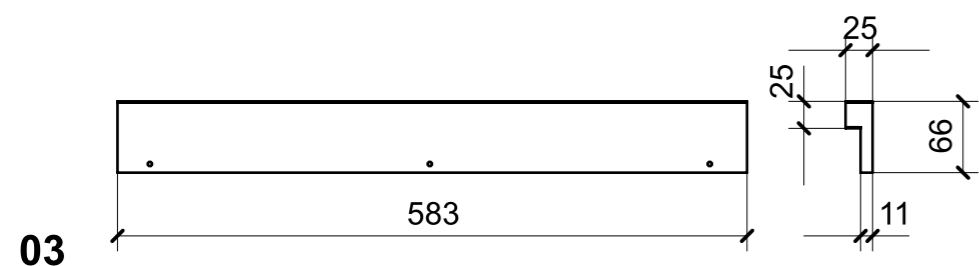
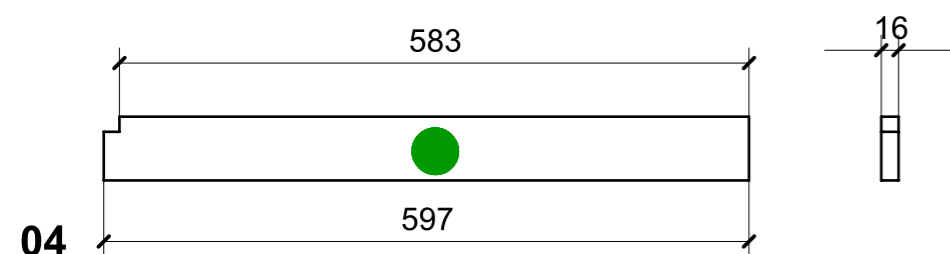
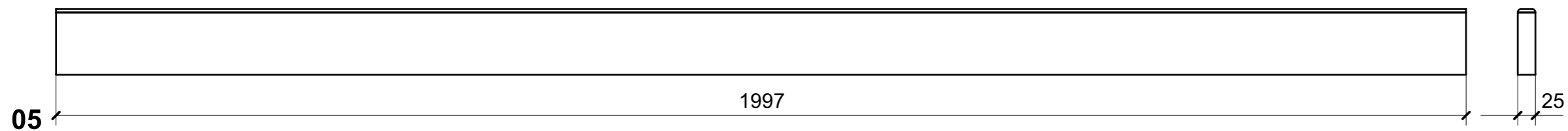

VERNICIATURA LASTRA/LACCATI:

● = VERNICIARE 1 LATO + FILI RASATI O BORDATI

NESSUN SIMBOLO = VERNICIARE 2 LATI + FILI RASATI O BORDATI

LOCALE	CODICE	DESCRIZIONE COMPONENTE	FINITURA	GR.
CABINA OSPITI DX	MD321_R02_RA01	SPECCHIERA TV	LASTRA ALPI JAY FLAMED 12.34	2

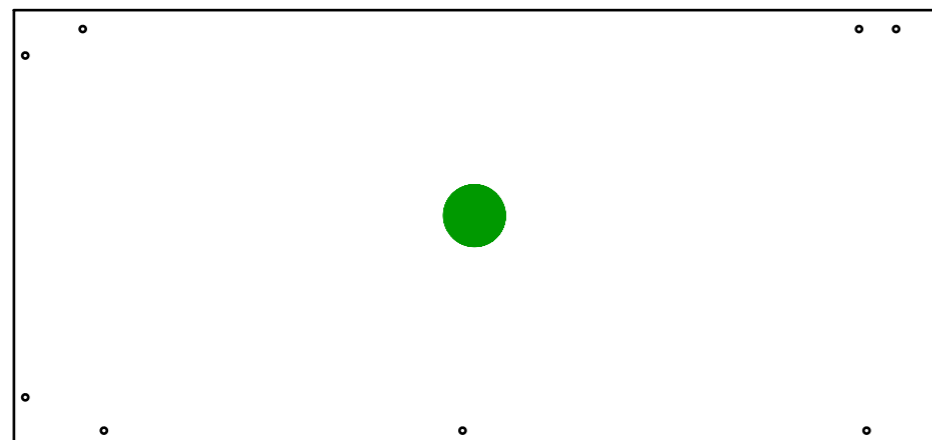

01

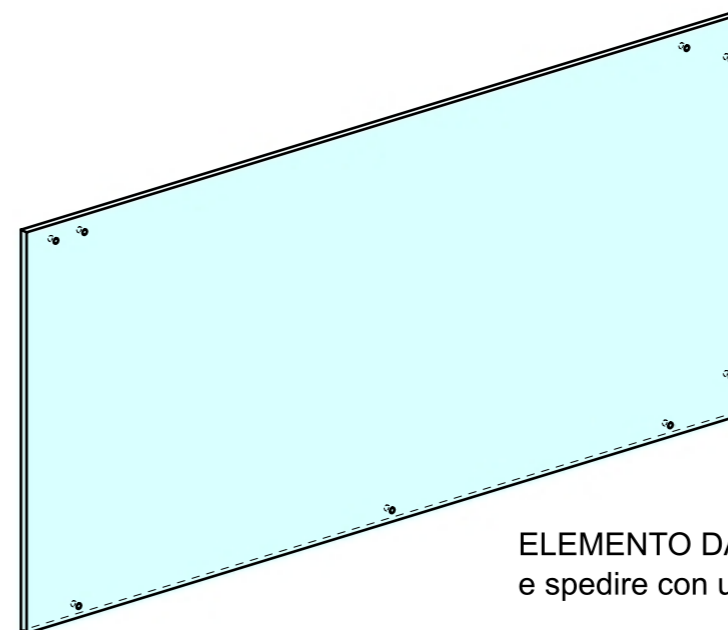

ELEMENTO DA MONTARE in MF_RA01
e spedire con unico imballo

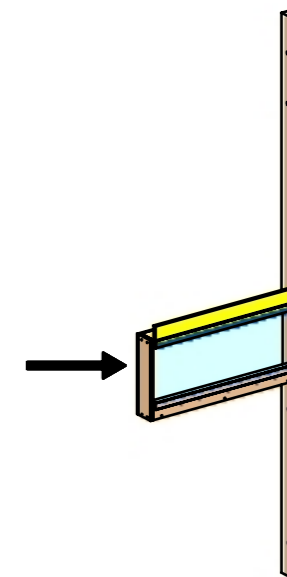

VERNICIATURA LASTRA/LACCATI:

● = VERNICIARE 1 LATO + FILI RASATI O BORDATI

NESSUN SIMBOLO = VERNICIARE 2 LATI + FILI RASATI O BORDATI

LOCALE	CODICE	DESCRIZIONE COMPONENTE	FINITURA	GR.
CABINA OSPITI DX	MD321_R01_RB01	ARMADIO	LASTRA ALPI JAY STRIPED 12.35	2

ELEMENTI DA MONTARE in MG_RB01
e spedire con unico imballo

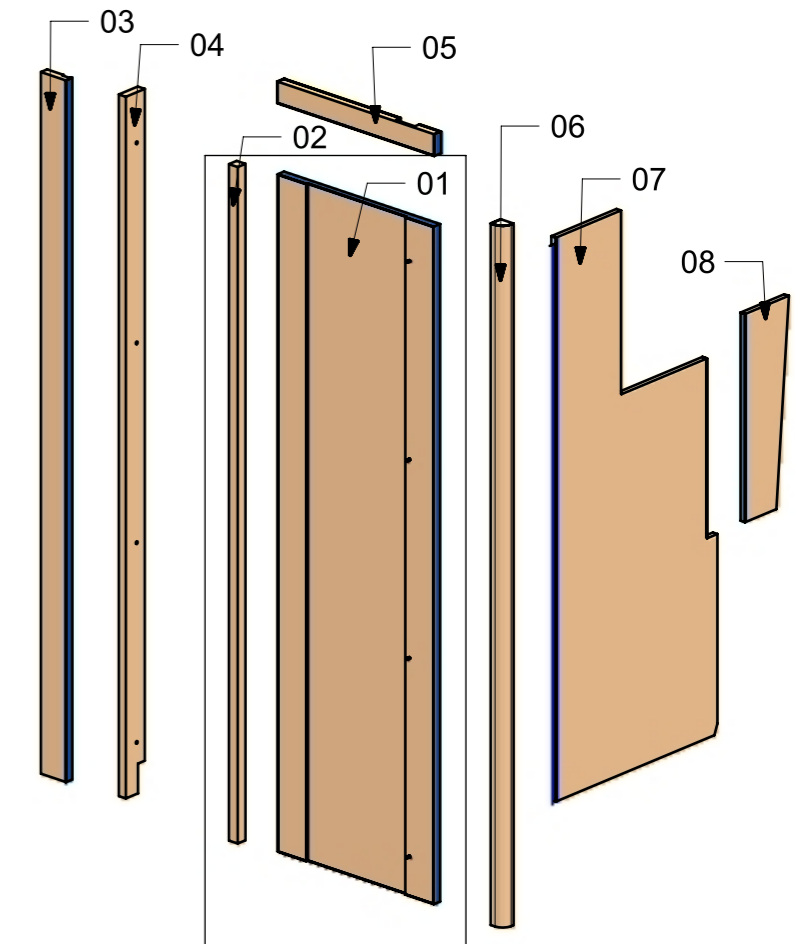
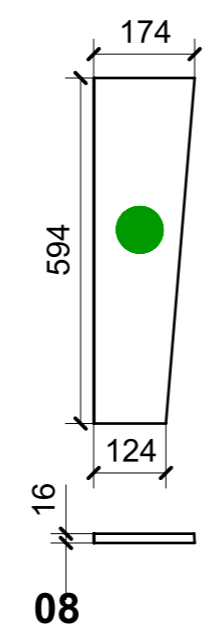
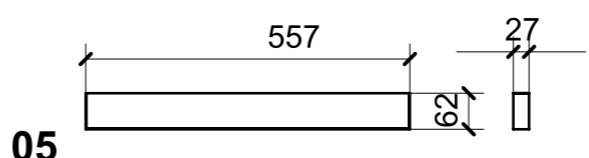
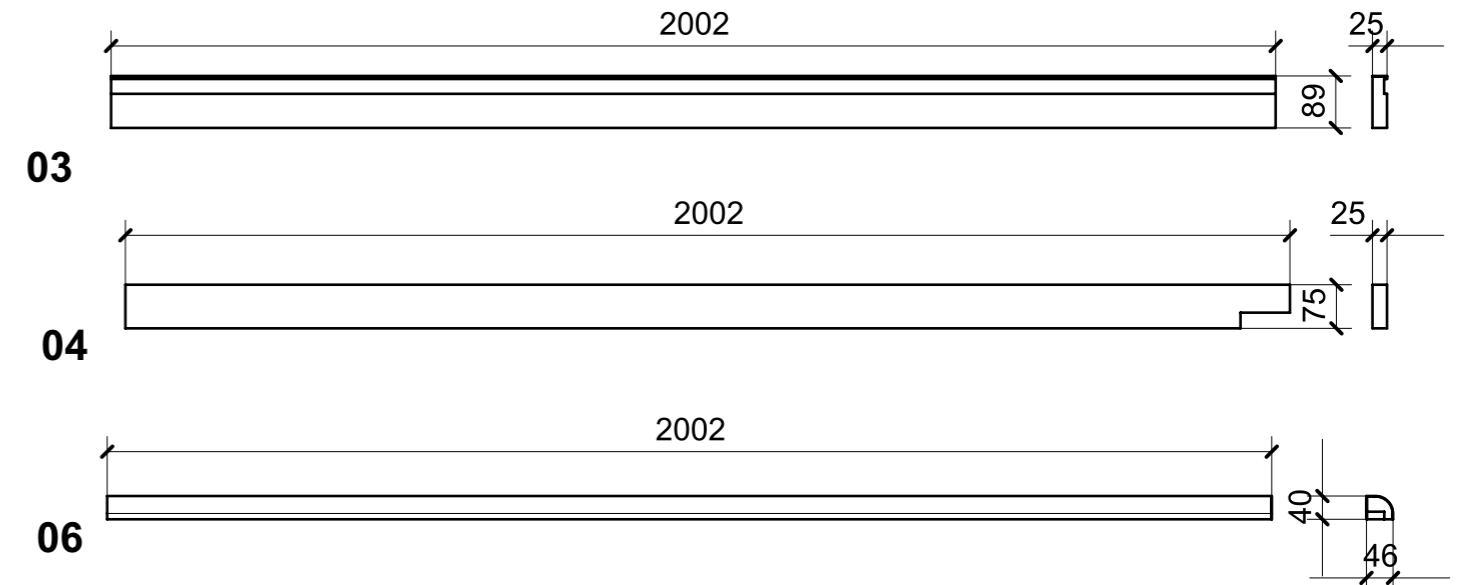
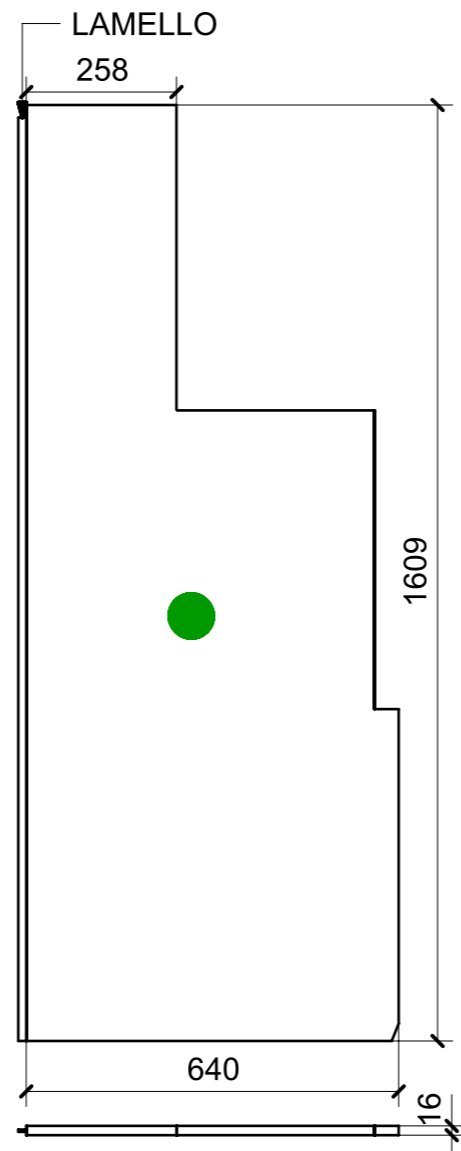
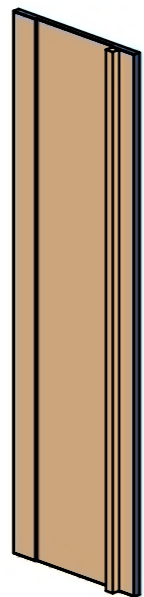
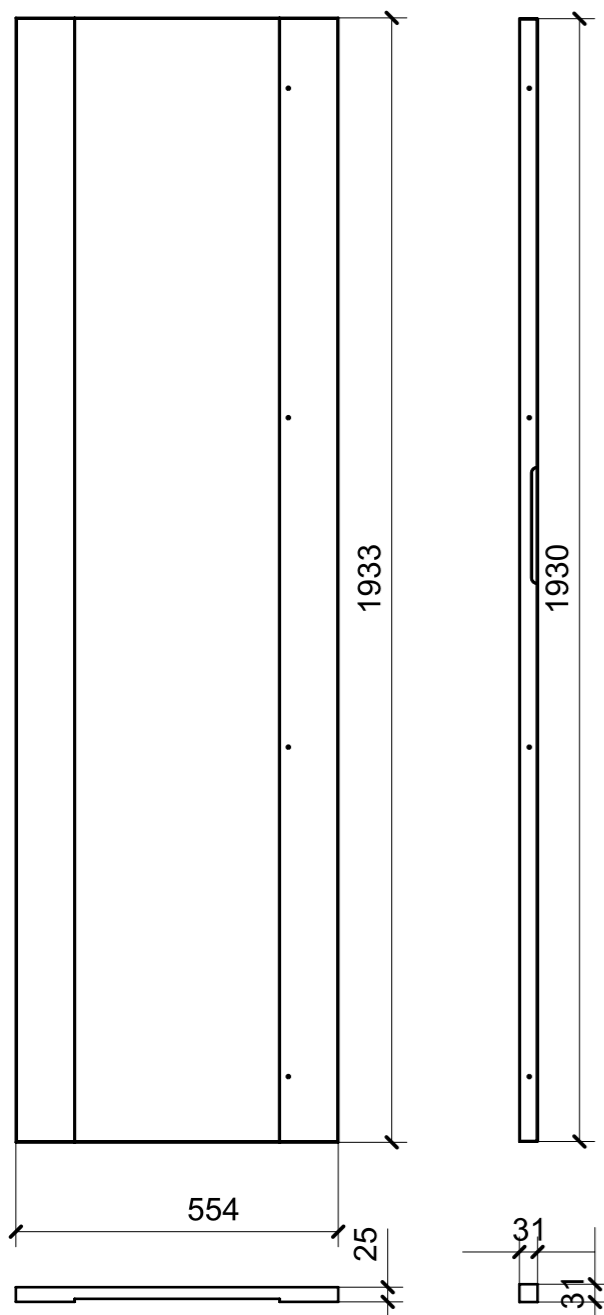

01

02

07

03

04

06

05

08

FERRAMENTA	QTY
BUSSOLA 5MA ANKOR BORGHI X CERNIERA COLLO PIENO	8
MAGNETE FORZA MAGNETICA1-5 10KG_HAFELE_246.87.112	2
BUSSOLA 5MA ANKOR BORGHI	4
VITE 4MA X 35 TESTA SVASATA ESAGONALE NERA_FBC_21104	4
FITLOCK M_MASCHERPA_3MM_6020202101	8
BUSSOLA 6MA X 10 FORO DIAM.8	7

VERNICIATURA LASTRA/LACCATI: ● = VERNICIARE 1 LATO + FILI RASATI O BORDATI. NESSUN SIMBOLO = VERNICIARE 2 LATI + FILI RASATI O BORDATI.

LOCALE	CODICE	DESCRIZIONE COMPONENTE	FINITURA	GR.
CABINA OSPITI DX	MD321_R01_RC01	LETTO MURATA	LASTRA ALPI JAY STRIPPED 12.35 ALPI	2

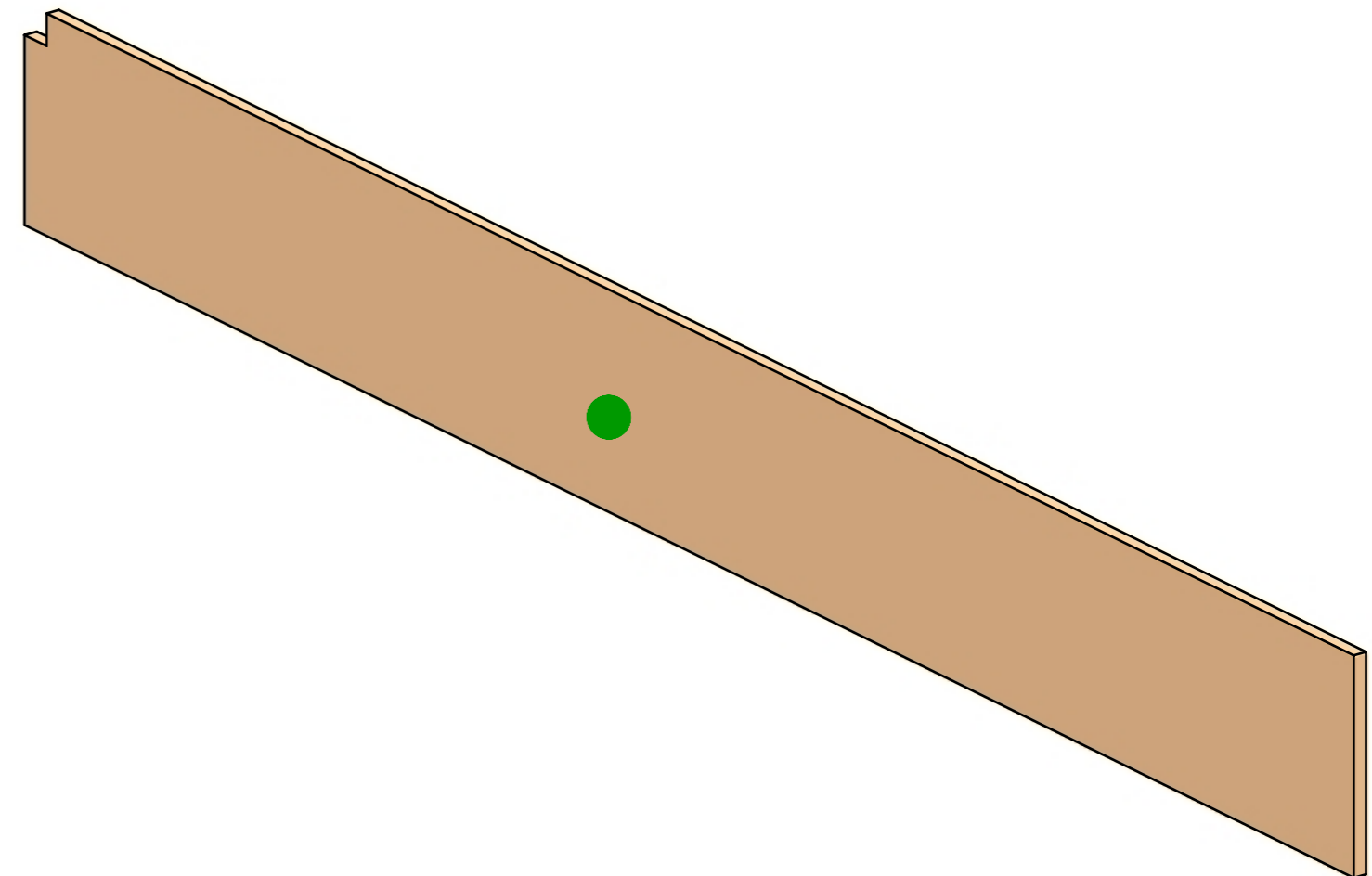
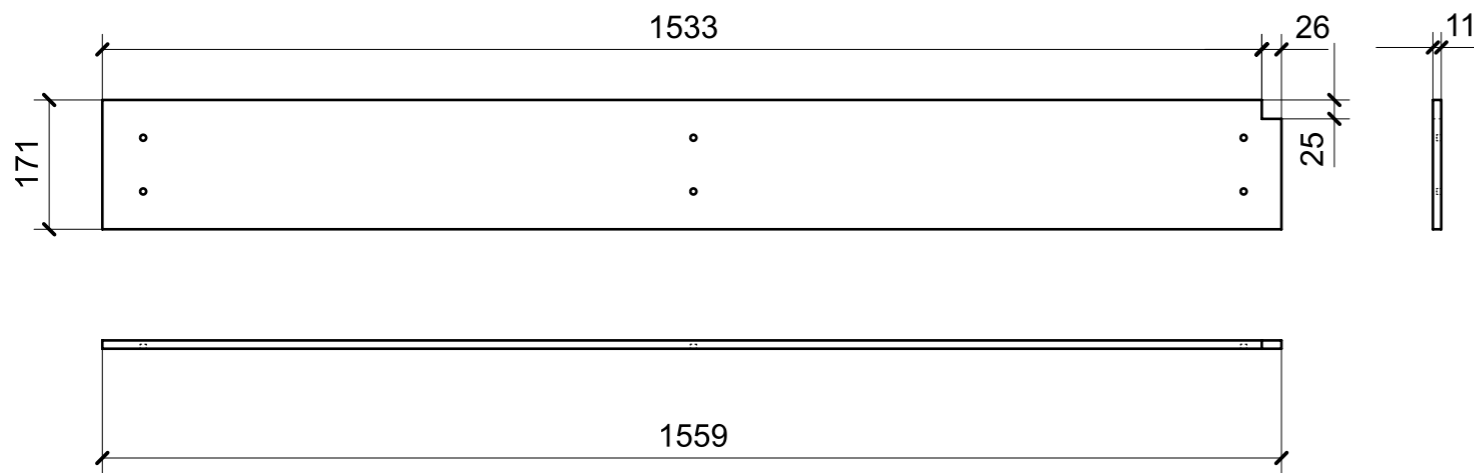

VERNICIATURA LASTRA/LACCATI:
 ● = VERNICIARE 1 LATO + FILI RASATI O BORDATI NESSUN SIMBOLO = VERNICIARE 2 LATI + FILI RASATI O BORDATI

LOCALE	CODICE	DESCRIZIONE COMPONENTE	FINITURA	GR.
CABINA OSPITI DX	MD321_R01_RD01	STRUTTURA MURATA	LASTRA ALPI JAY STRIPED 12.35	2

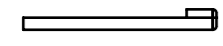
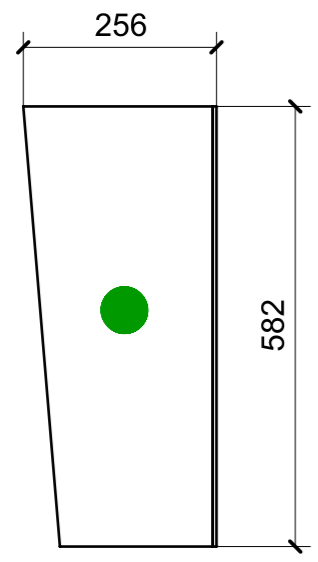
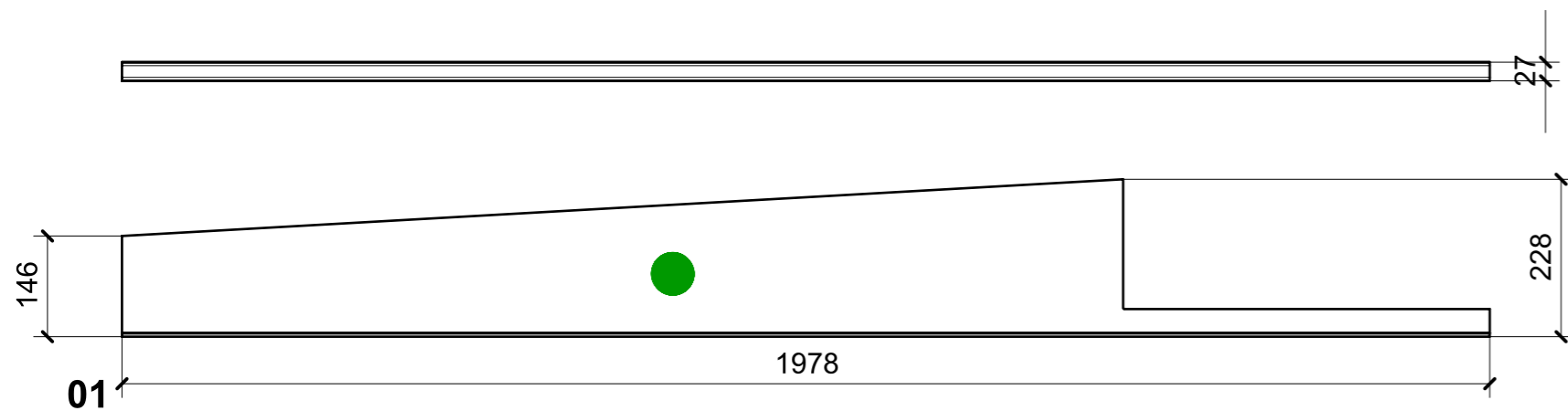

02

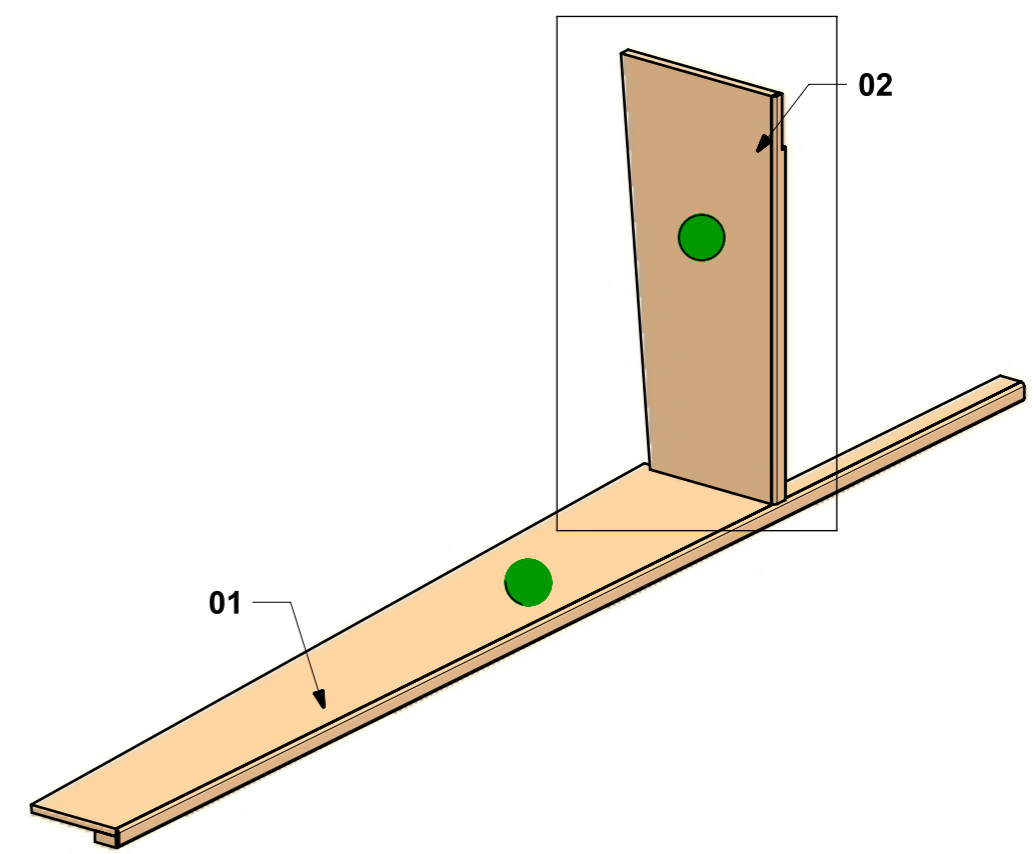

FERRAMENTA	QTY
BUSSOLA 6MA X 10 FORO DIAM.8	6

VERNICIATURA LASTRA/LACCATI:
 ● = VERNICIARE 1 LATO + FILI RASATI O BORDATI NESSUN SIMBOLO = VERNICIARE 2 LATI + FILI RASATI O BORDATI

LOCALE	CODICE	DESCRIZIONE COMPONENTE	FINITURA	GR.
CABINA OSPITI DX	MD321_R01_RE01	PENSILE	LASTRA ALPI JAY STRIPED 12.35	PTP

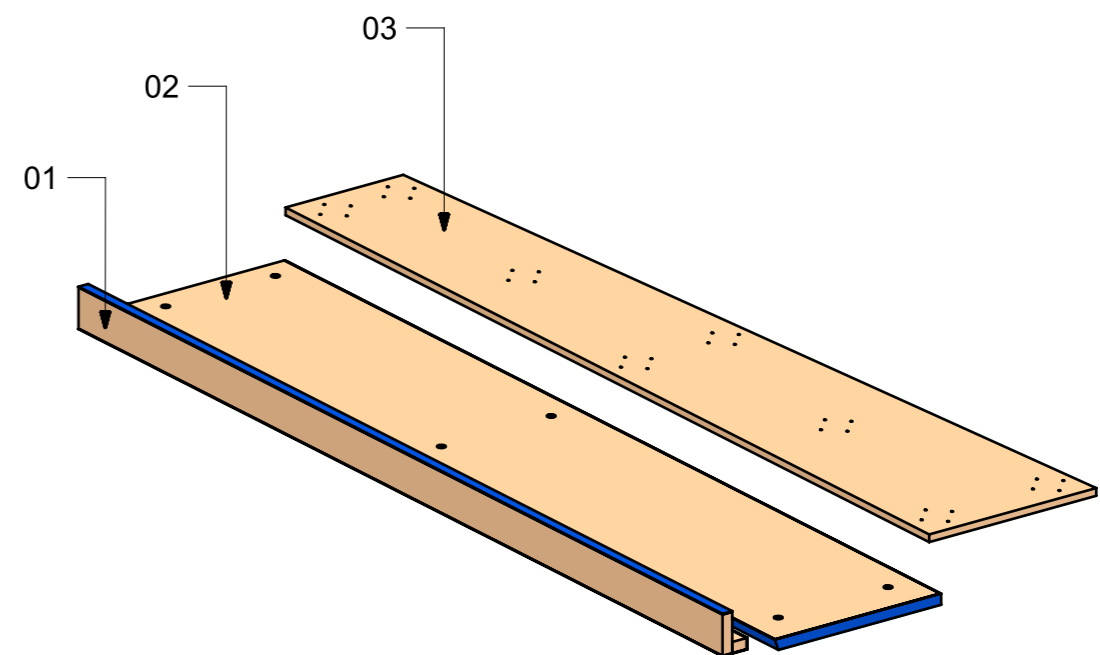
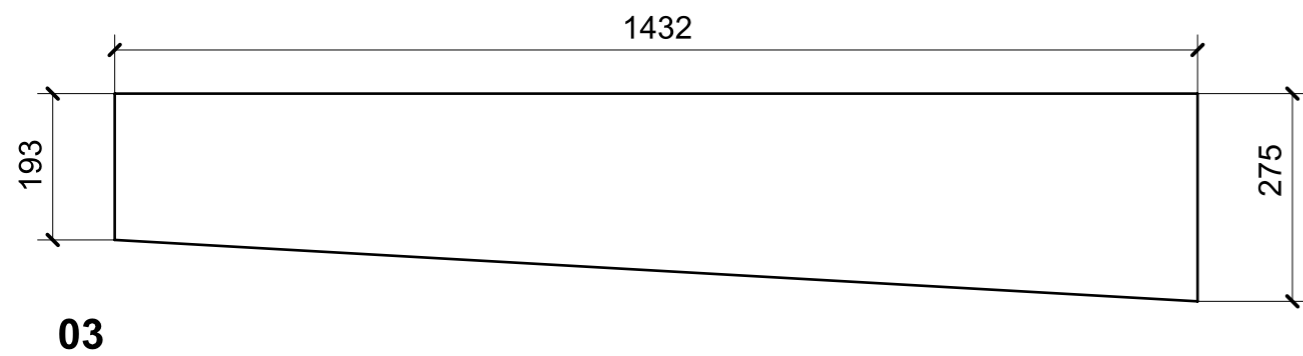
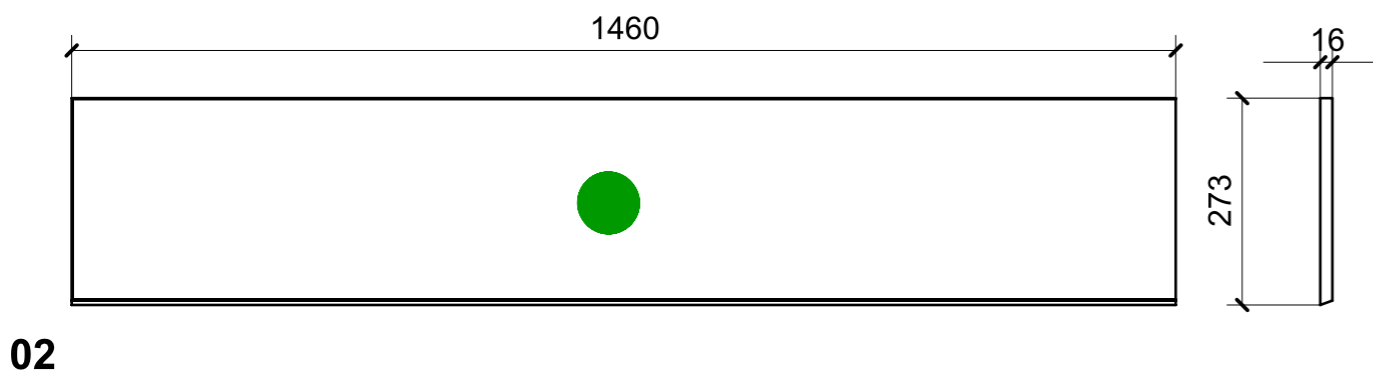
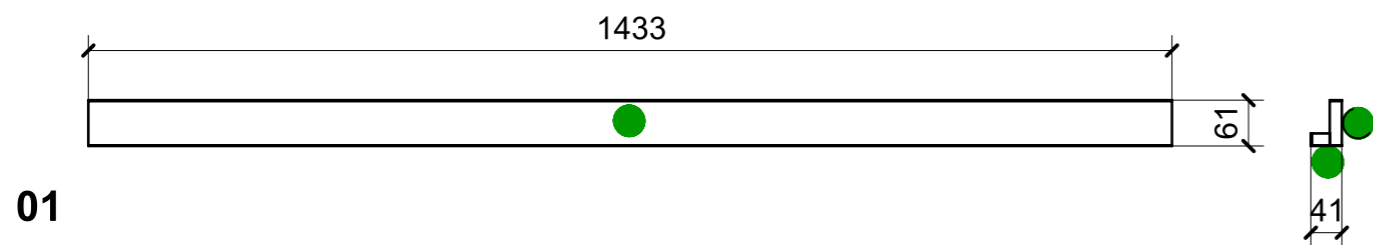

FERRAMENTA	QTY
BUSSOLA 6MA X 10 FORO DIAM.8	9

VERNICIATURA LASTRA/LACCATI:

● = VERNICIARE 1 LATO + FILI RASATI O BORDATI

NESSUN SIMBOLO = VERNICIARE 2 LATI + FILI RASATI O BORDATI

LOCALE	CODICE	DESCRIZIONE COMPONENTE	FINITURA	GR.
CABINA OSPITI DX	MD321_R01_RF01	PLENUM	LASTRA ALPI JAY STRIPED 12.35	2

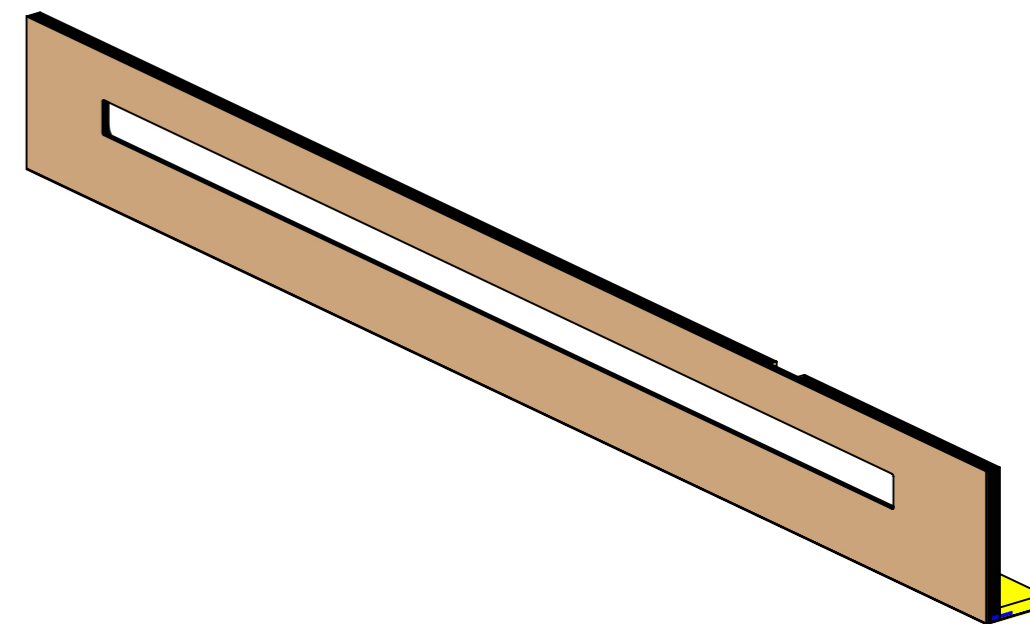
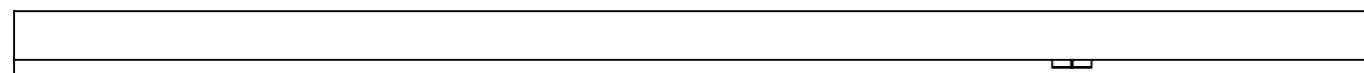
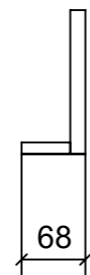
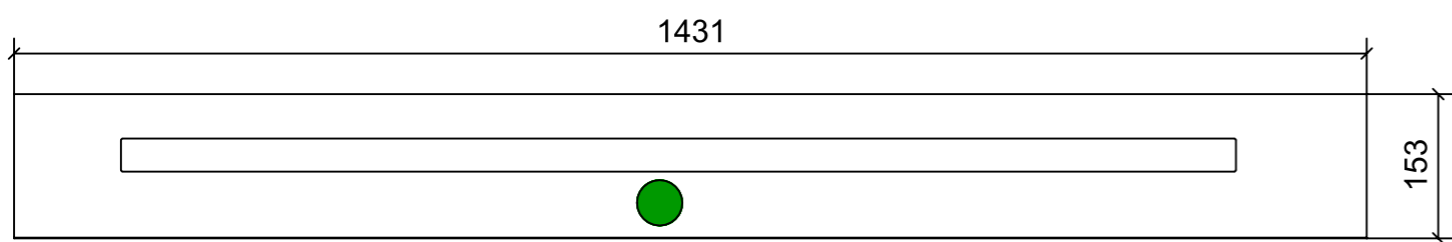

01

VERNICIATURA LASTRA/LACCATI:

● = VERNICIARE 1 LATO + FILI RASATI O BORDATI

NESSUN SIMBOLO = VERNICIARE 2 LATI + FILI RASATI O BORDATI

LOCALE	CODICE	DESCRIZIONE COMPONENTE	FINITURA	GR.
CABINA OSPITI DX	MD321_R01_RRH01	COMODINO CENTRALE VAR 2	LASTRA ALPI JAY STRIPED 12.35	2

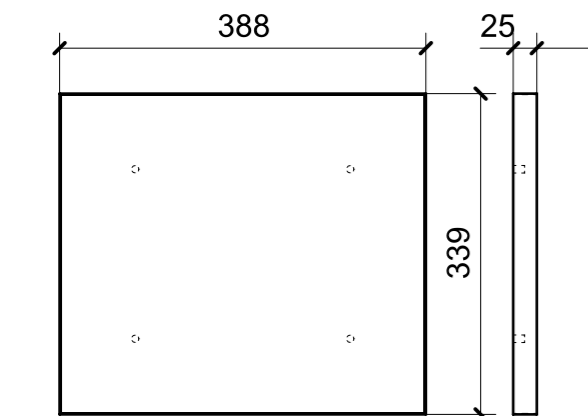
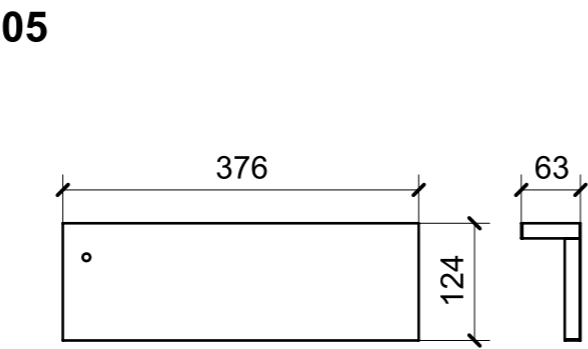
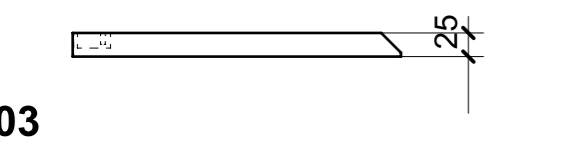
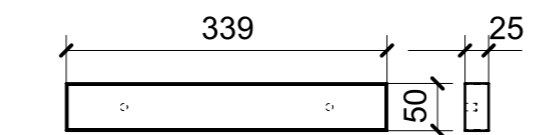
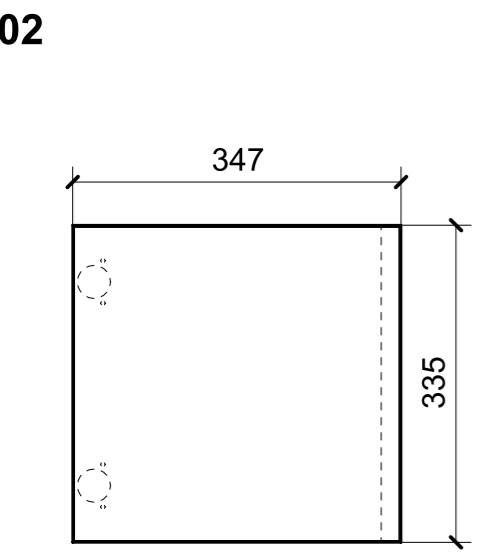
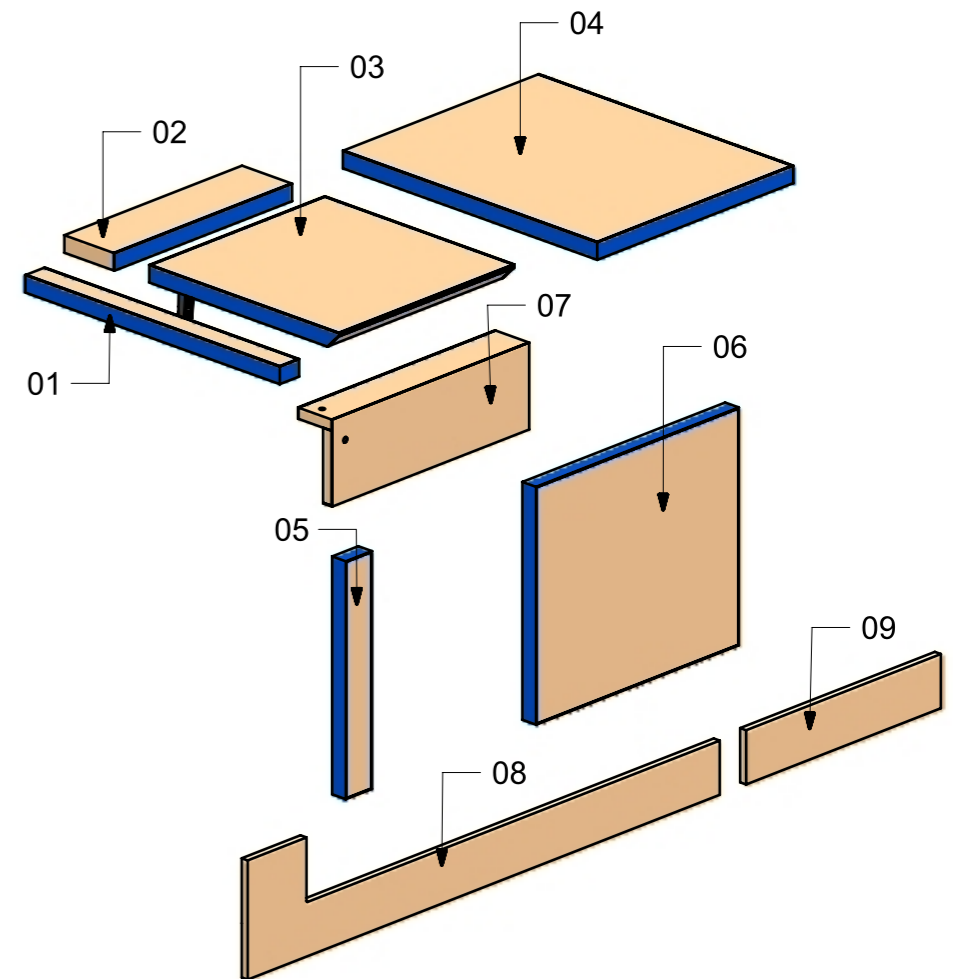
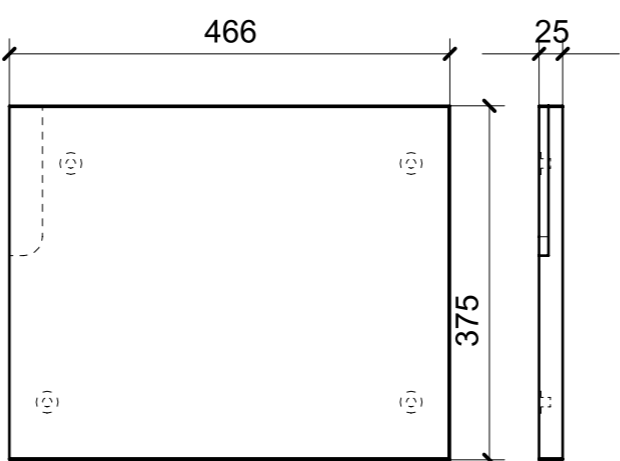
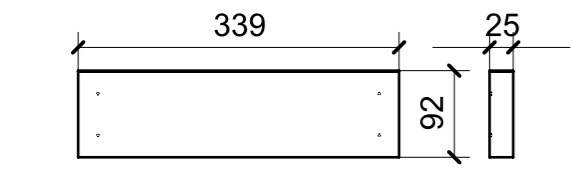
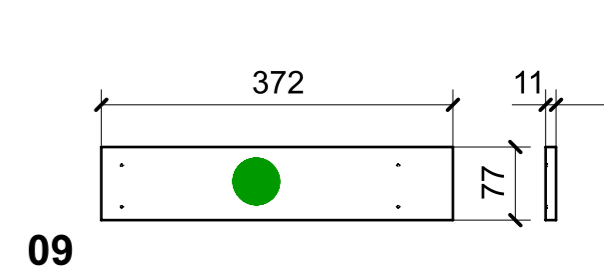
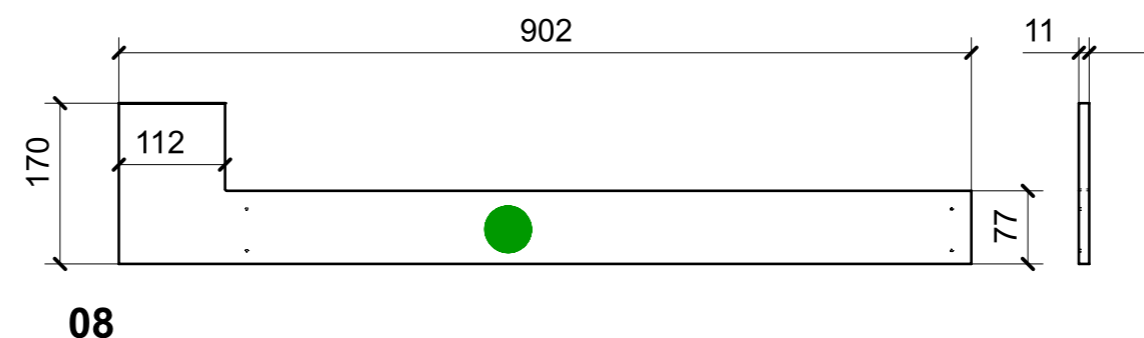
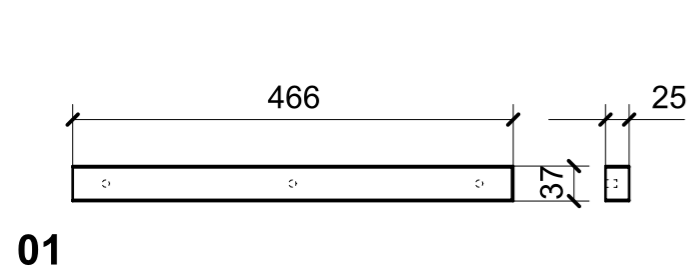

FERRAMENTA	QTY
BUSSOLA 5MA ANKOR BORGHI X CERNIERA COLLO PIENO	4
BUSSOLA 6MA X 10 FORO DIAM.8	4
CERNIERA 95°_COLLO PIENO-NERA_HAFELE_342.46.606-BLUM_71B9750.STP	2
MS INCASSO_ITALVIPLA_972_FMPC_M1B	4

06

VERNICIATURA LASTRA/LACCATI:
 ● = VERNICIARE 1 LATO + FILI RASATI O BORDATI NESSUN SIMBOLO = VERNICIARE 2 LATI + FILI RASATI O BORDATI

LOCALE	CODICE	DESCRIZIONE COMPONENTE	FINITURA	GR.
CABINA OSPITI DX	MD321_R02_RRH01	COMODINO CENTRALE VAR 2	LASTRA ALPI JAY FLAMED 12.34	2

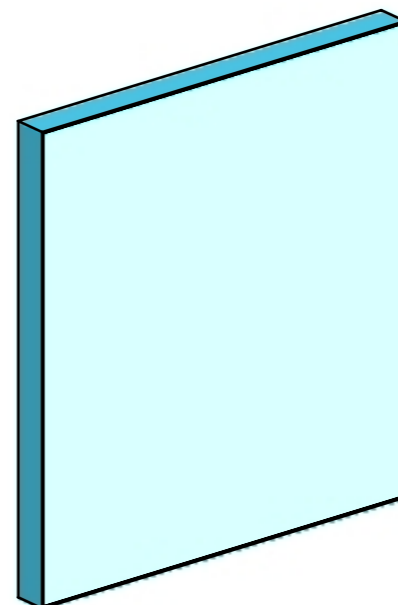
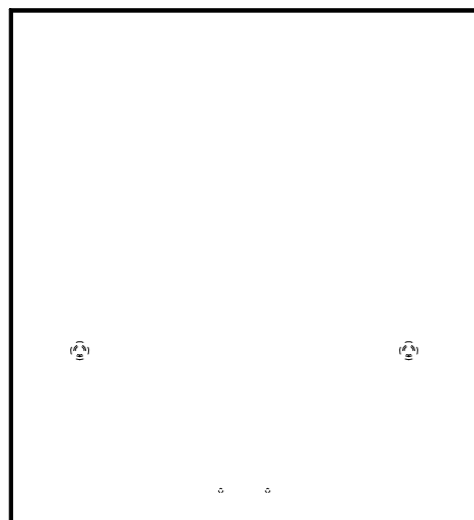

01

FERRAMENTA	QTY
BUSSOLA 6MA X 10 FORO DIAM.8	2

VERNICIATURA LASTRA/LACCATI:

● = VERNICIARE 1 LATO + FILI RASATI O BORDATI

NESSUN SIMBOLO = VERNICIARE 2 LATI + FILI RASATI O BORDATI

LOCALE	CODICE	DESCRIZIONE COMPONENTE	FINITURA	GR.
CABINA OSPITI DX	MD321_R01_RI01	COMODINO	LAISTRA ALPI JAY STRIPED 12.35	2

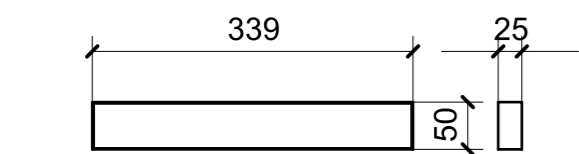

01

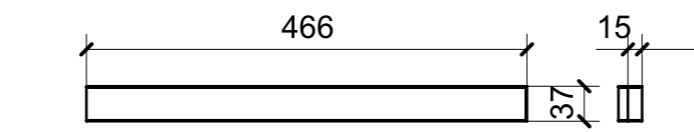

05

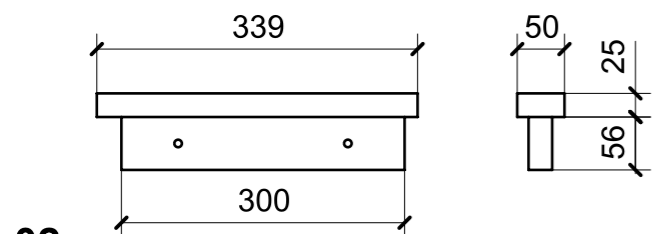

02

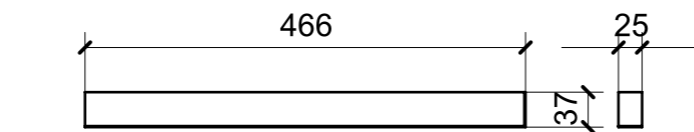

06

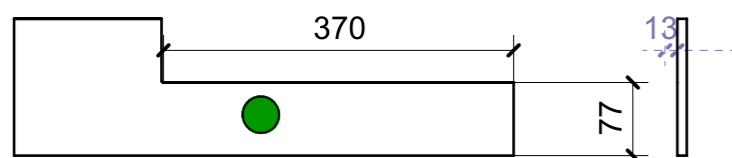

03

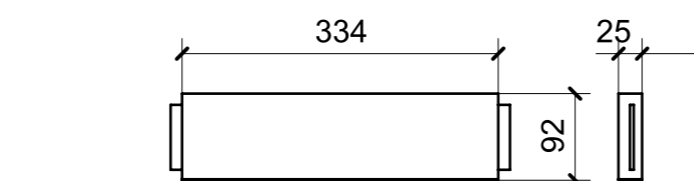

07

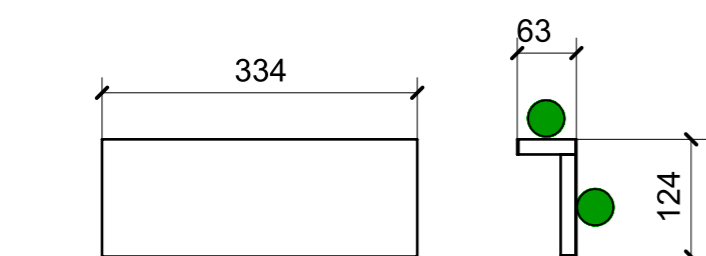

04

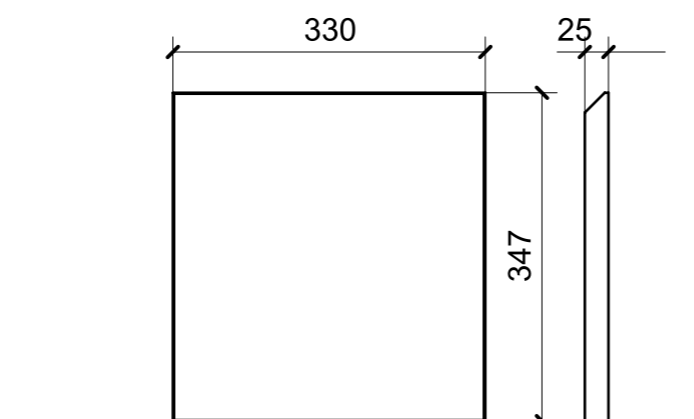

08

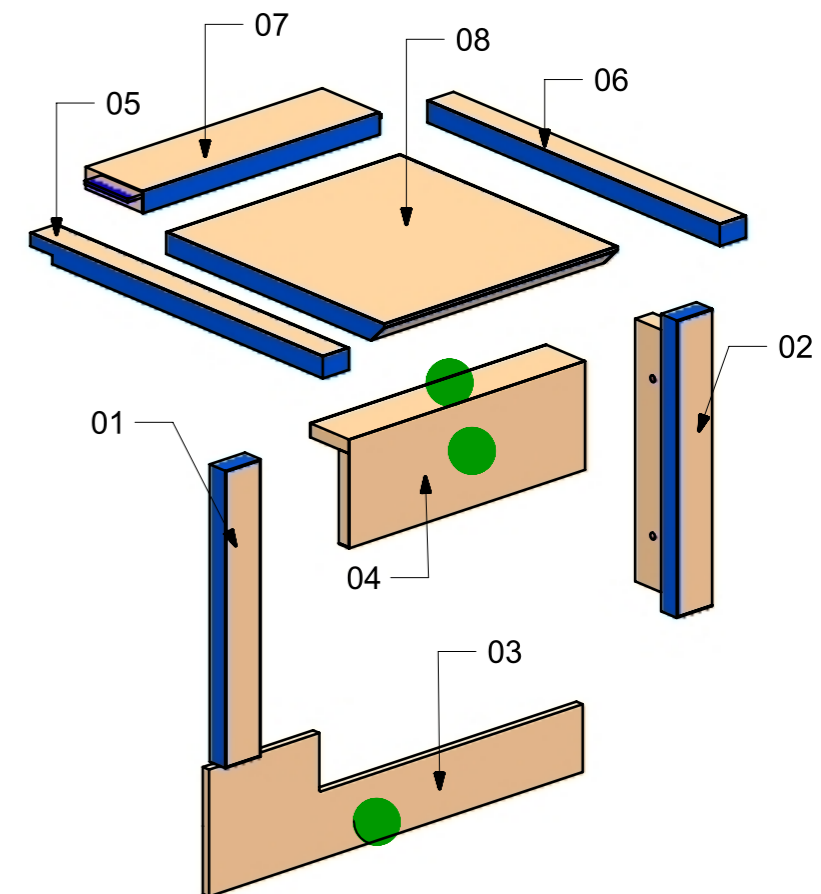

FERRAMENTA	QTY
BUSSOLA 5MA ANKOR BORGHI X CERNIERA COLLO PIENO	4
BUSSOLA 6MA X 10 FORO DIAM.8	2

VERNICIATURA LASTRA/LACCATI:

● = VERNICIARE 1 LATO + FILI RASATI O BORDATI

NESSUN SIMBOLO = VERNICIARE 2 LATI + FILI RASATI O BORDATI

LOCALE	CODICE	DESCRIZIONE COMPONENTE	FINITURA	GR.
CABINA OSPITI DX	MD321_R02_RI01	COMODINO	LASTRA ALPI JAY FLAMED 12.34	2

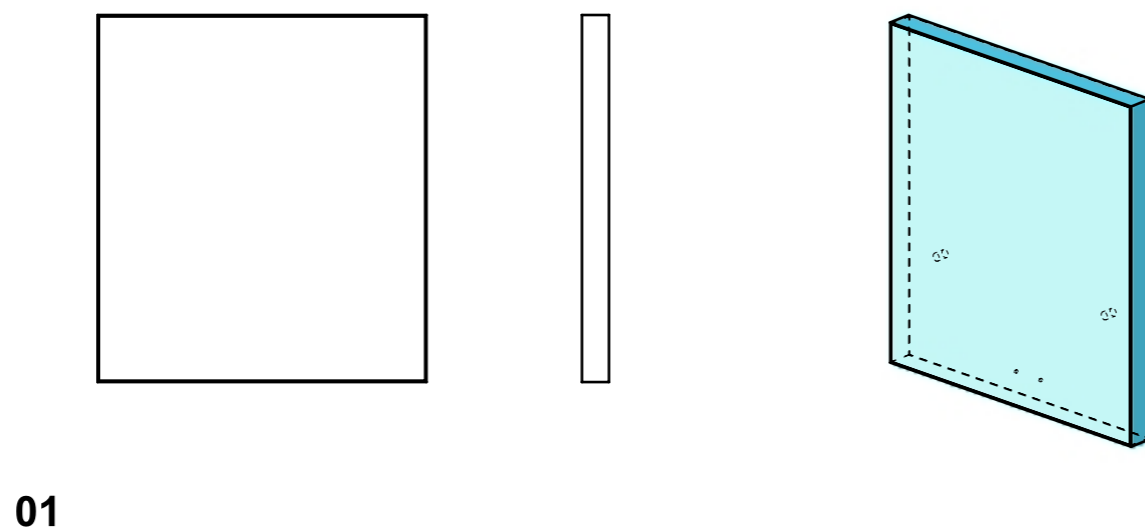

FERRAMENTA	QTY
BUSSOLA 6MA X 10 FORO DIAM.8	2

VERNICIATURA LASTRA/LACCATI:

● = VERNICIARE 1 LATO + FILI RASATI O BORDATI

NESSUN SIMBOLO = VERNICIARE 2 LATI + FILI RASATI O BORDATI

LOCALE	CODICE	DESCRIZIONE COMPONENTE	FINITURA	GR.
CABINA OSPITI DX	MD321_R01_RL01	LETTO CENTRO BARCA VAR 1	LAISTRA ALPI JAY STRIPED 12.35	2

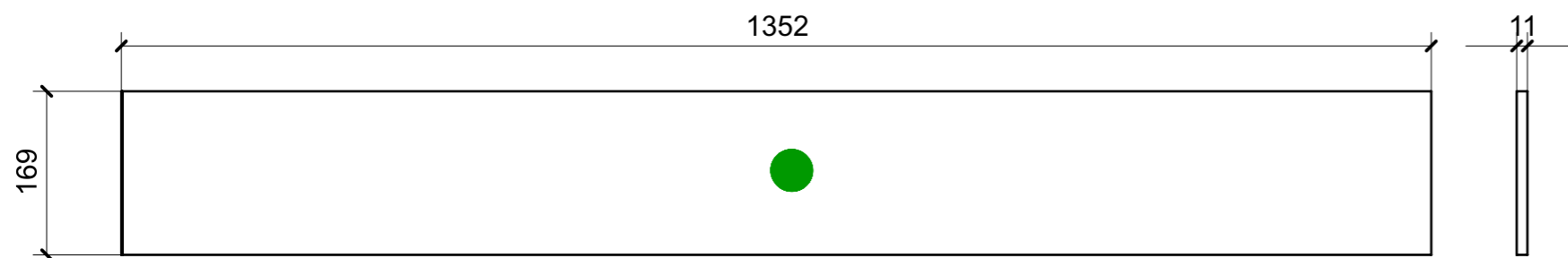

01

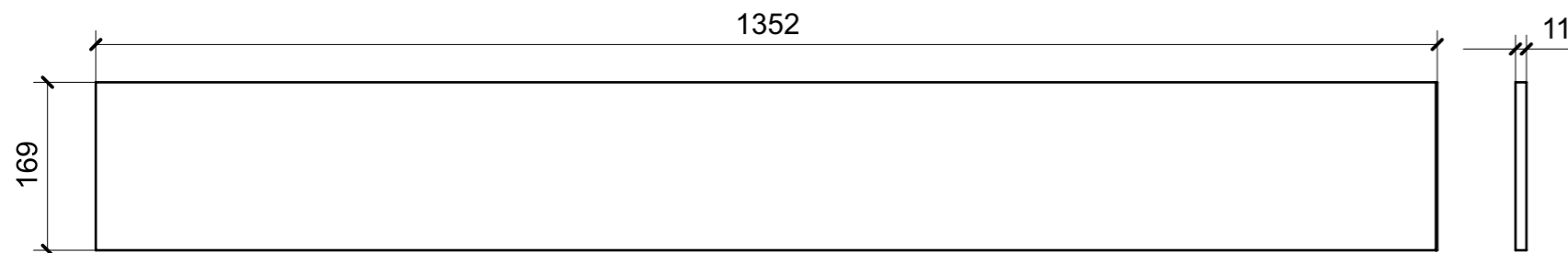

03

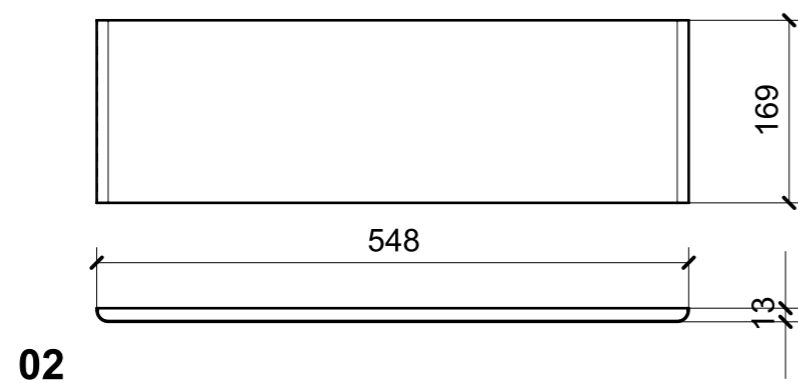

02

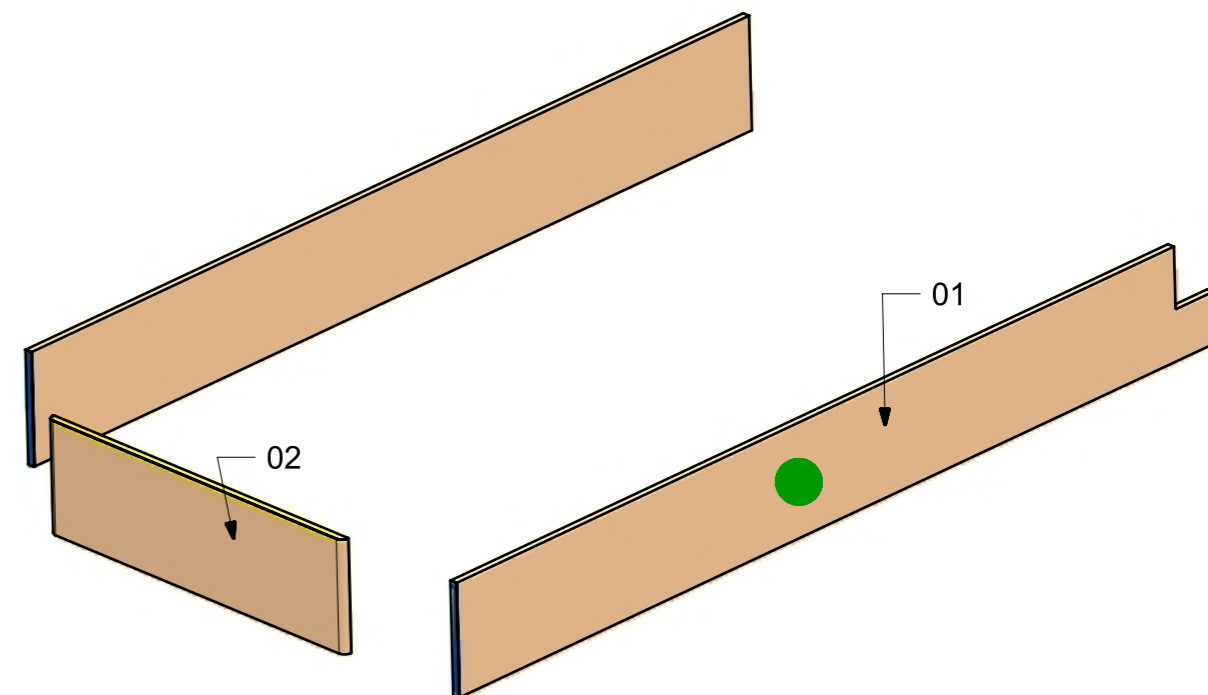

VERNICIATURA LASTRA/LACCATI:

● = VERNICIARE 1 LATO + FILI RASATI O BORDATI

NESSUN SIMBOLO = VERNICIARE 2 LATI + FILI RASATI O BORDATI

LOCALE	CODICE	DESCRIZIONE COMPONENTE	FINITURA	GR.
CABINA OSPITI DX	MD321_R01_RRL01	KIT LETTI SCORREVOLI VARIABILE 2	LASTRA ALPI JAY STRIPED 12.35	2

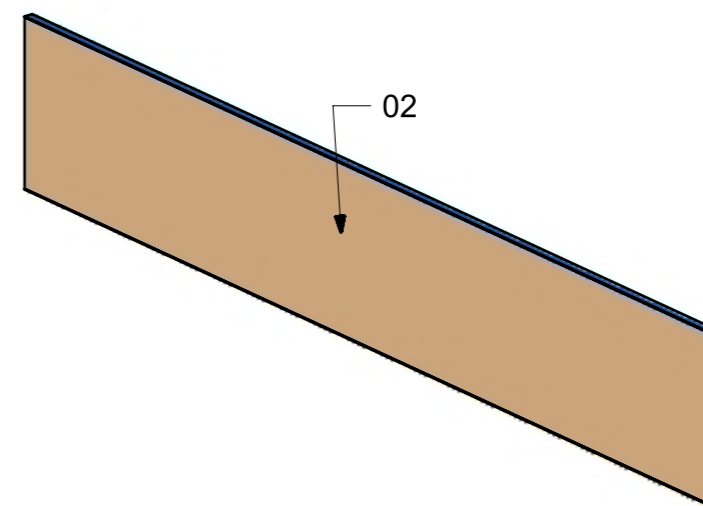
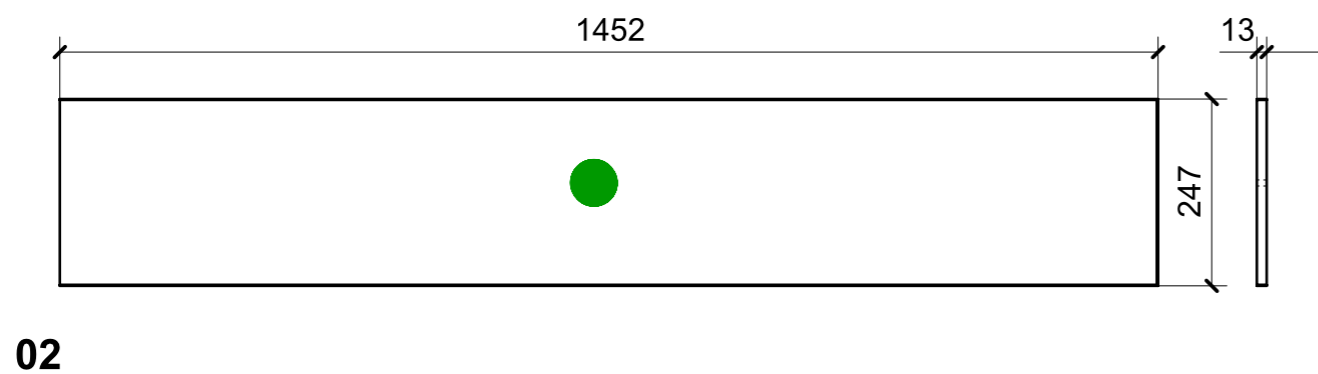
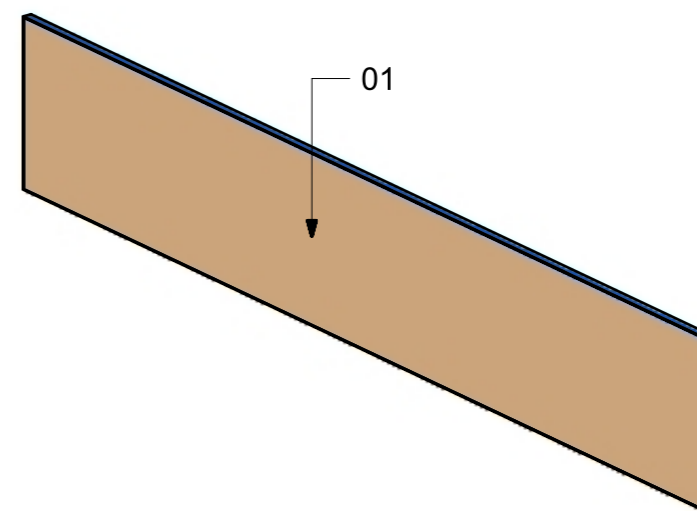
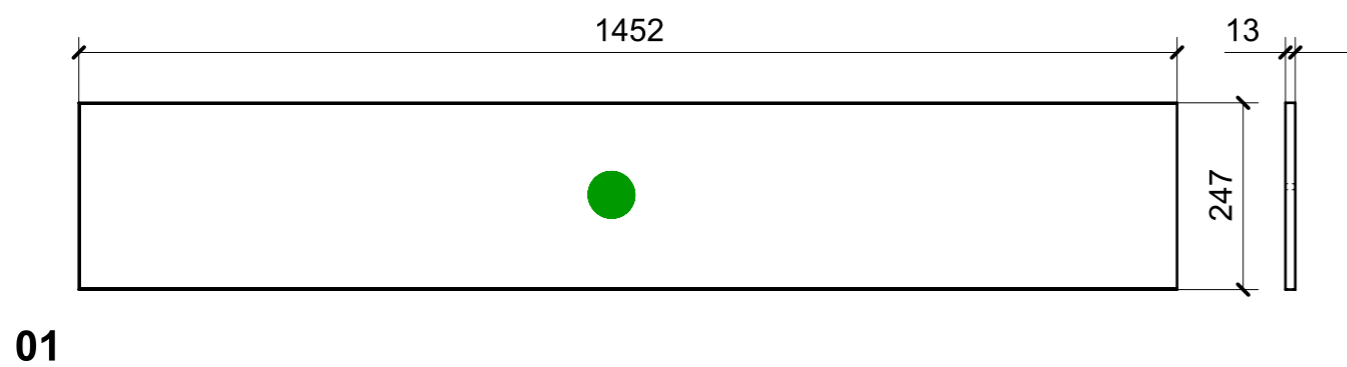

VERNICIATURA LASTRA/LACCATI:

● = VERNICIARE 1 LATO + FILI RASATI O BORDATI

NESSUN SIMBOLO = VERNICIARE 2 LATI + FILI RASATI O BORDATI

LOCALE	CODICE	DESCRIZIONE COMPONENTE	FINITURA	GR.
CABINA OSPITI DX	MD321_R01_RM01	TESTATA LETTO	LASTRA ALPI JAY STRIPED 12.35	PTP

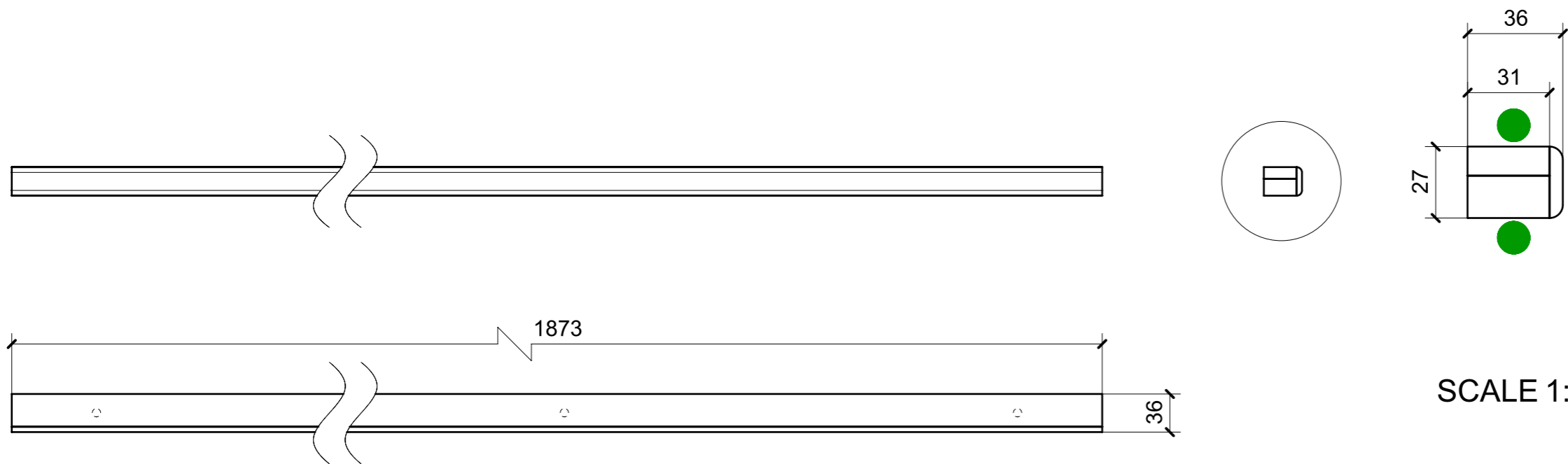

SCALE 1:2

01

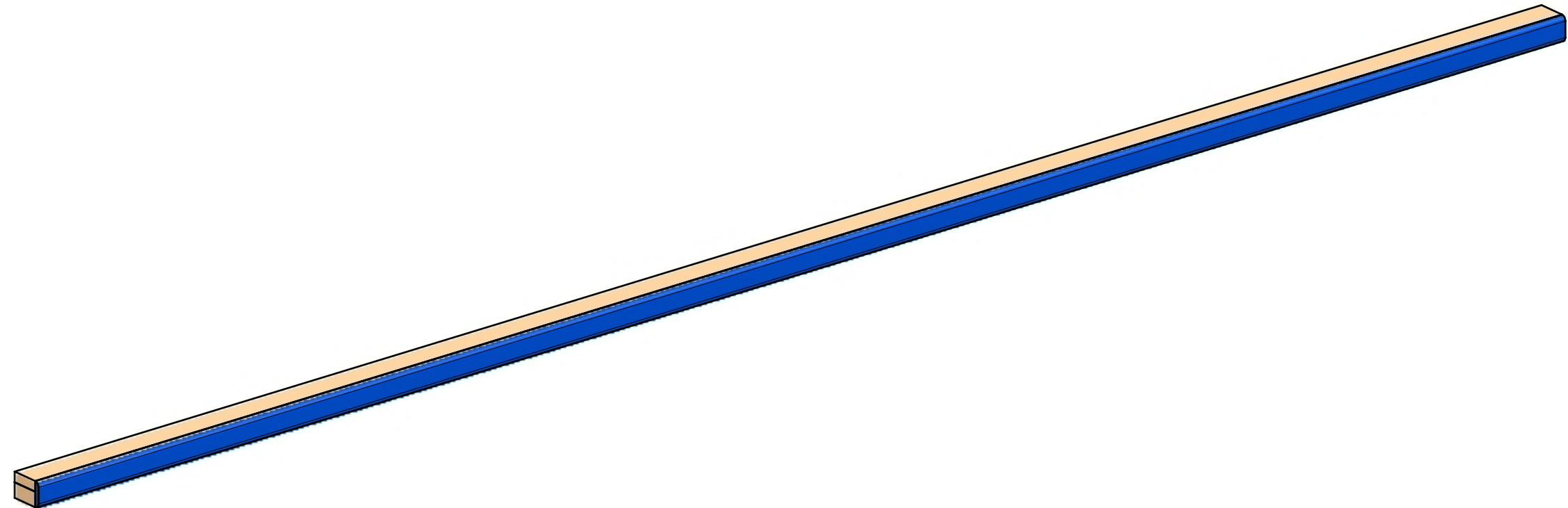

VERNICIATURA LASTRA/LACCATI:
 ● = VERNICIARE 1 LATO + FILI RASATI O BORDATI
 NESSUN SIMBOLO = VERNICIARE 2 LATI + FILI RASATI O BORDATI

LOCALE	CODICE	DESCRIZIONE COMPONENTE	FINITURA	GR.
CABINA OSPITI DX	MD321_R01_RN01	PANNELLO RIV. ORIZZONTALE SOPRA TESTATA LETTO	LASTRA ALPI JAY STRIPED 12.35	PTP

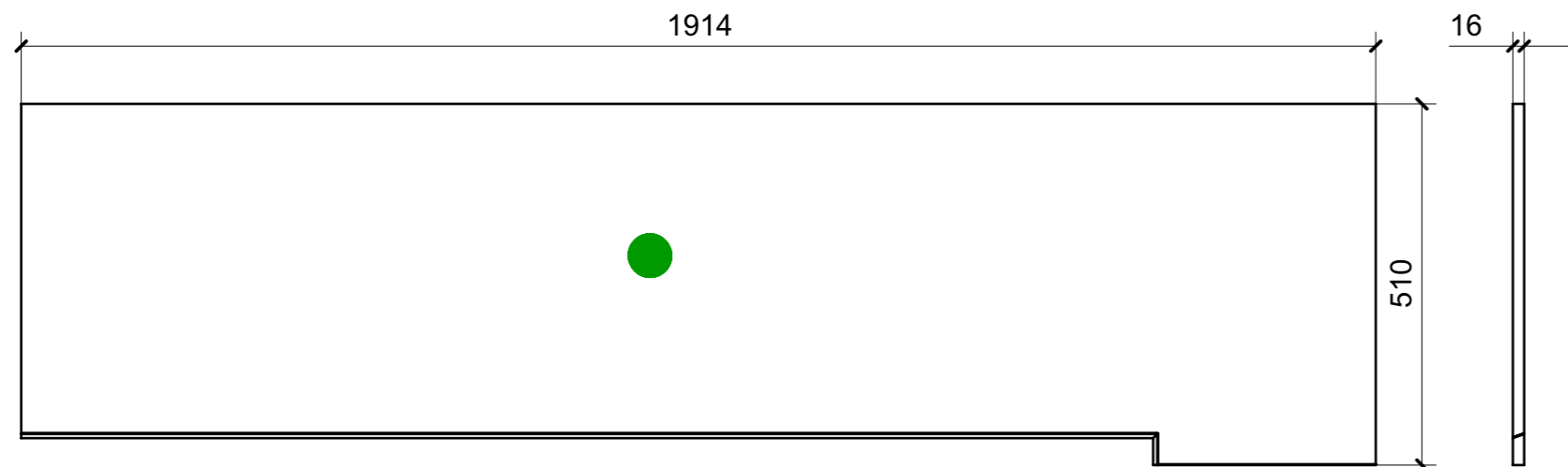

01

02

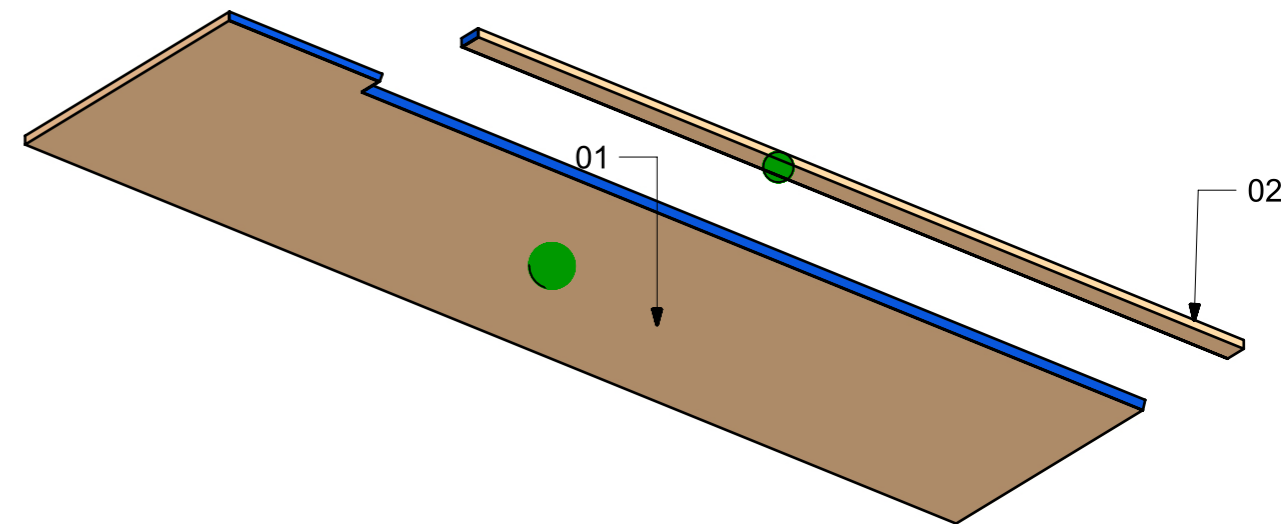
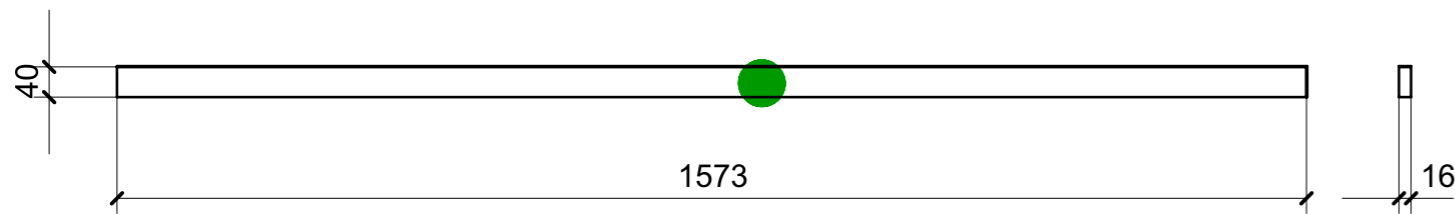

FERRAMENTA	QTY
BUSSOLA 6MA X 10 FORO DIAM.8	6

VERNICIATURA LASTRA/LACCATI:

● = VERNICIARE 1 LATO + FILI RASATI O BORDATI

NESSUN SIMBOLO = VERNICIARE 2 LATI + FILI RASATI O BORDATI

LOCALE	CODICE	DESCRIZIONE COMPONENTE	FINITURA	GR.
CABINA OSPITI DX	MD321_R01_RO01	PANNELLO RIV. VERTICALE SOPRA TESTATA LETTO	LASTRA ALPI JAY STRIPED 12.35	PTP

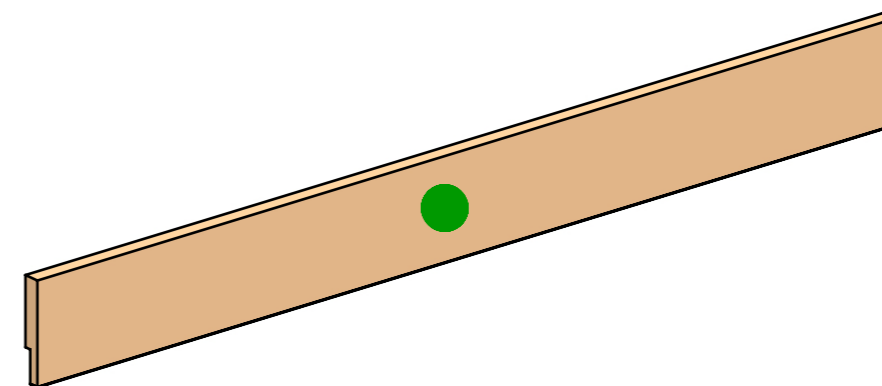
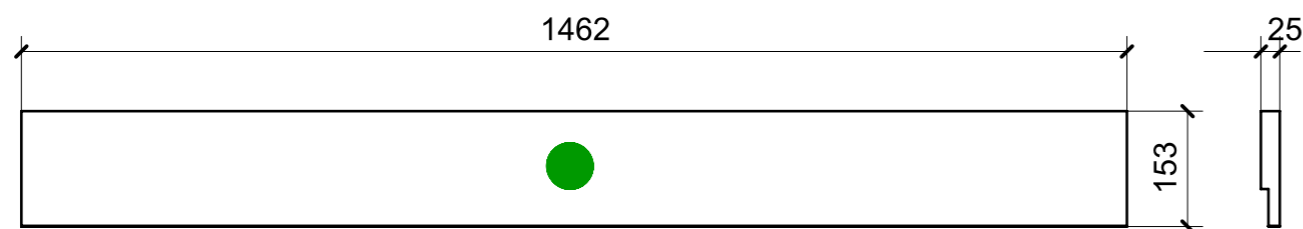

01

VERNICIATURA LASTRA/LACCATI:

● = VERNICIARE 1 LATO + FILI RASATI O BORDATI

NESSUN SIMBOLO = VERNICIARE 2 LATI + FILI RASATI O BORDATI