

| LOCALE     | CODICE         | DESCRIZIONE COMPONENTE                | FINITURA                       | GR. |
|------------|----------------|---------------------------------------|--------------------------------|-----|
| PARATIE LD | MD321_R01_PR01 | PARATIA TRAVERSO NAVE CABINA ARMATORE | LAISTRA ALPI JAY STRIPED 12.35 | 2   |

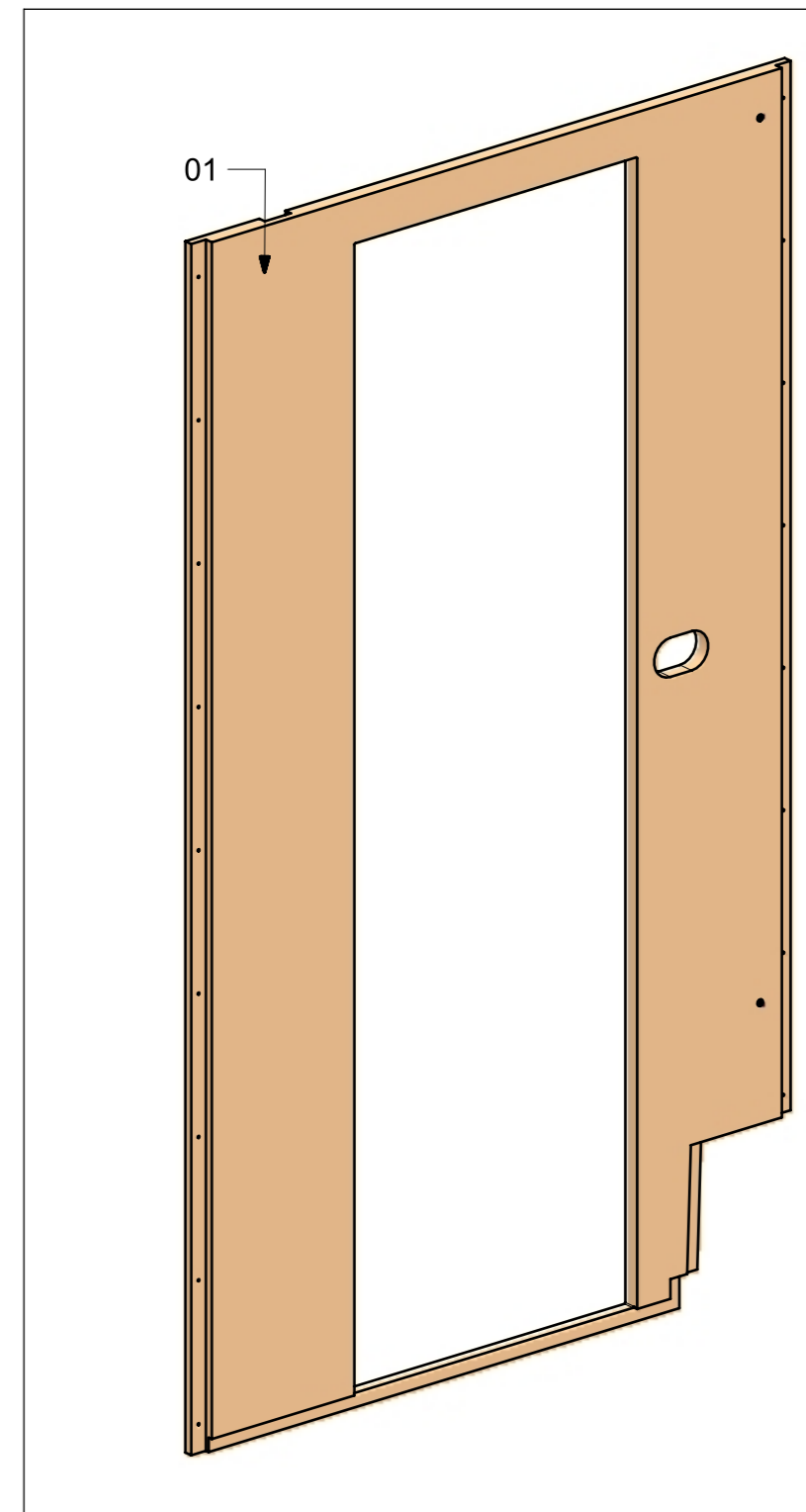
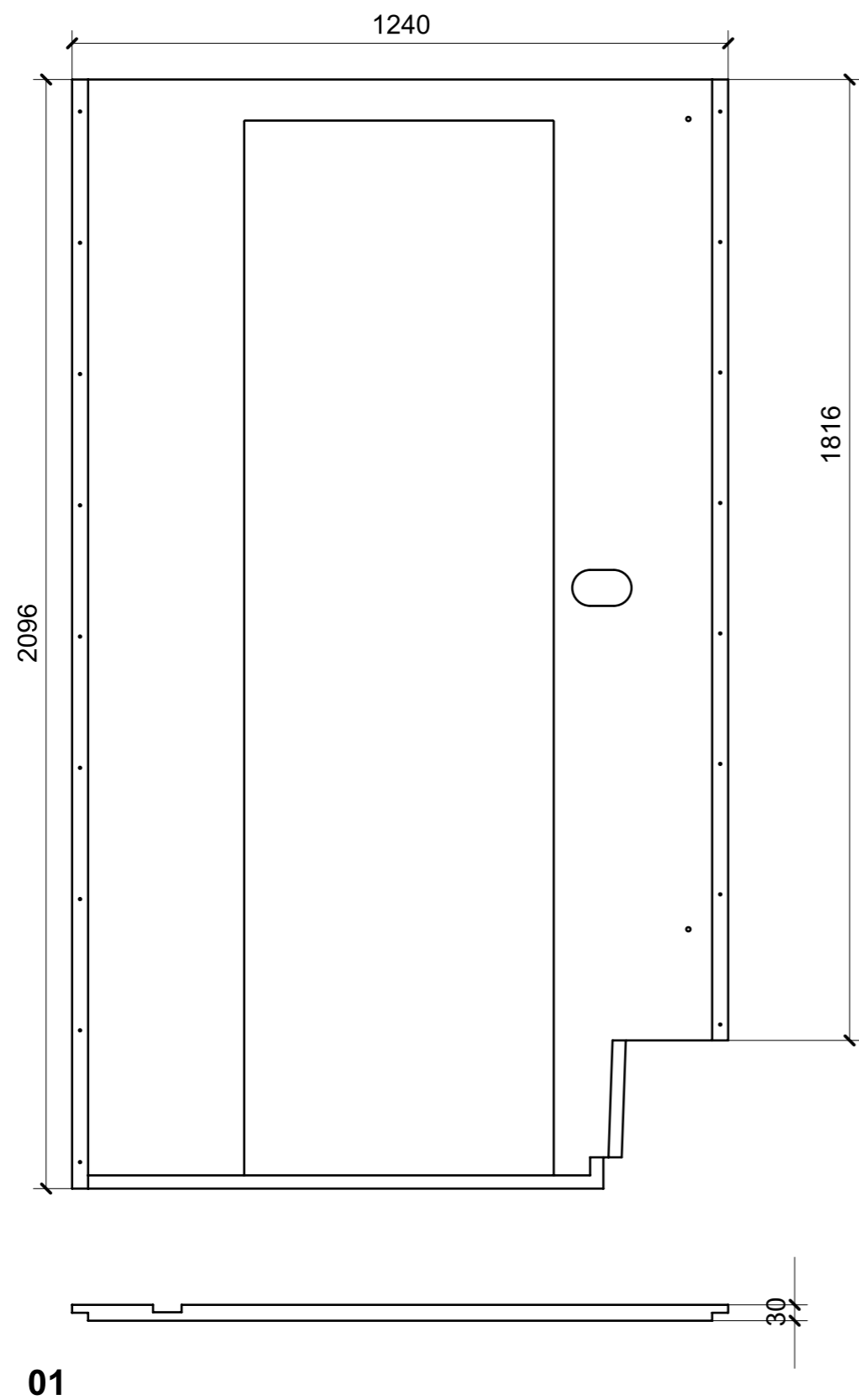

VERNICIATURA LASTRA/LACCATI:

● = VERNICIARE 1 LATO + FILI RASATI O BORDATI

NESSUN SIMBOLO = VERNICIARE 2 LATI + FILI RASATI O BORDATI

| LOCALE     | CODICE         | DESCRIZIONE COMPONENTE                 | FINITURA                      | GR. |
|------------|----------------|--|-------------------------------|-----|
| PARATIE LD | MD321_R01_PR02 | PARATIA INGRESSO DOCCIA BAGNO ARMATORE | LASTRA ALPI JAY STRIPED 12.35 | PTP |

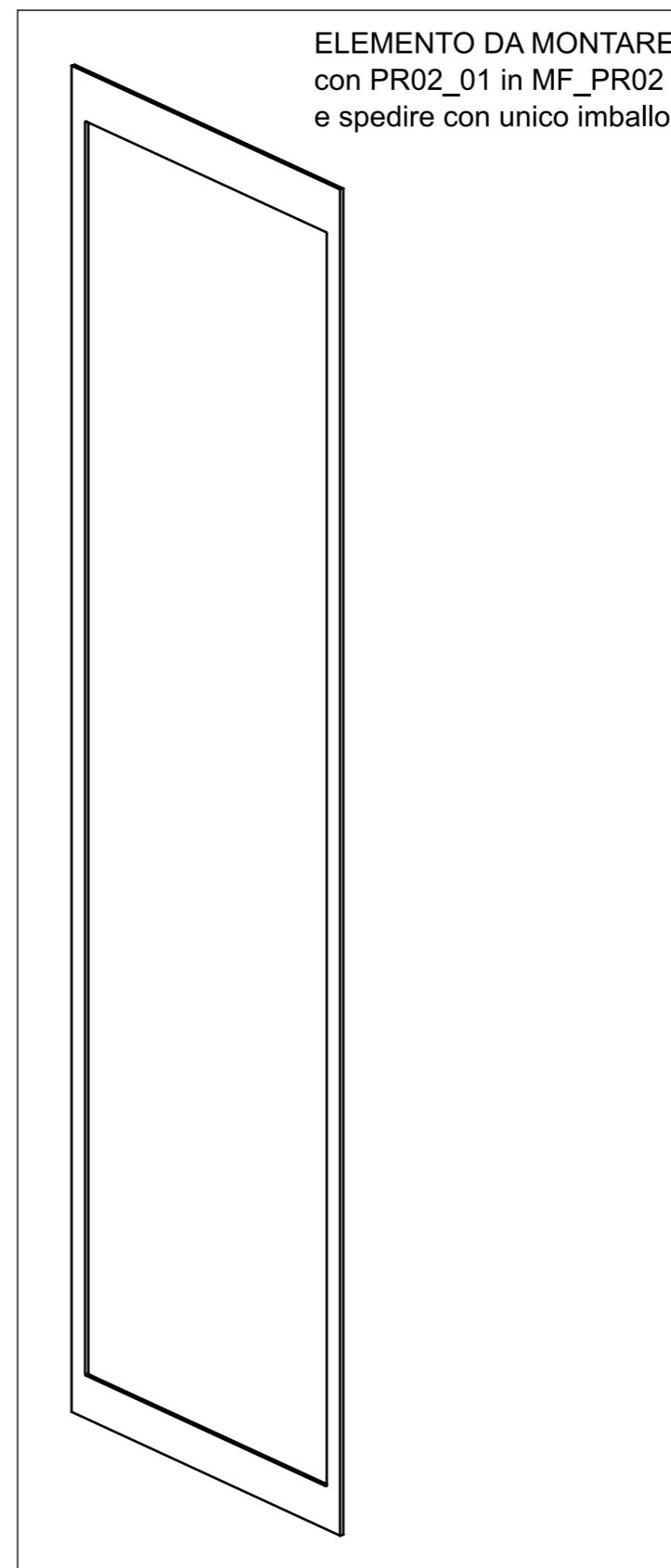
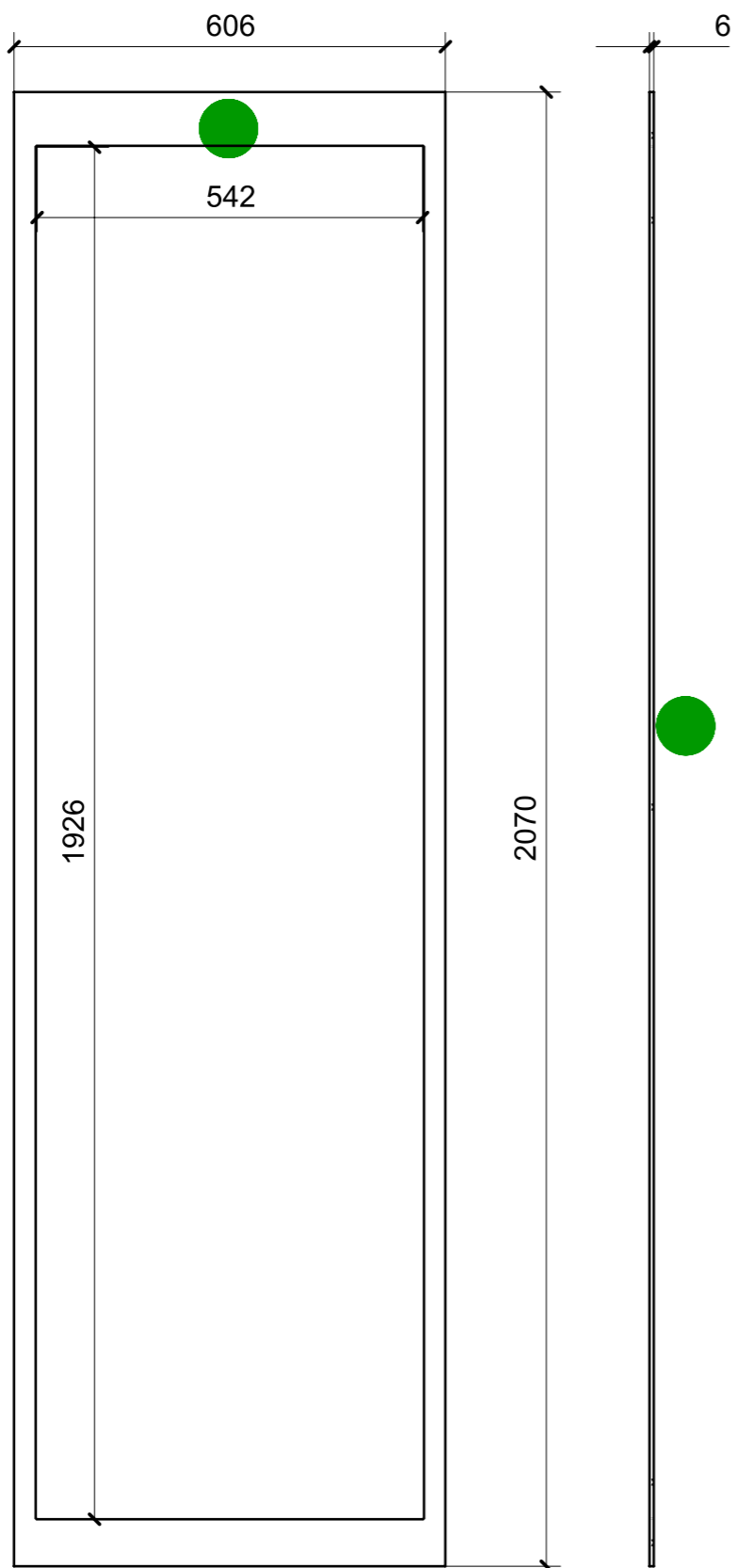

01

VERNICIATURA LASTRA/LACCATI:

● = VERNICIARE 1 LATO + FILI RASATI O BORDATI

NESSUN SIMBOLO = VERNICIARE 2 LATI + FILI RASATI O BORDATI

| LOCALE     | CODICE         | DESCRIZIONE COMPONENTE           | FINITURA                      | GR. |
|------------|----------------|----------------------------------|-------------------------------|-----|
| PARATIE LD | MD321_R01_PR03 | PARATIA DOCCIA INGRESSO ARMATORE | LASTRA ALPI JAY STRIPED 12.35 | PTP |

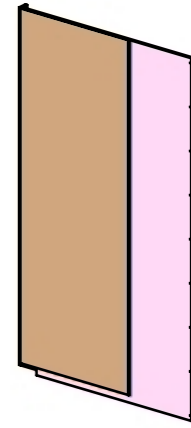
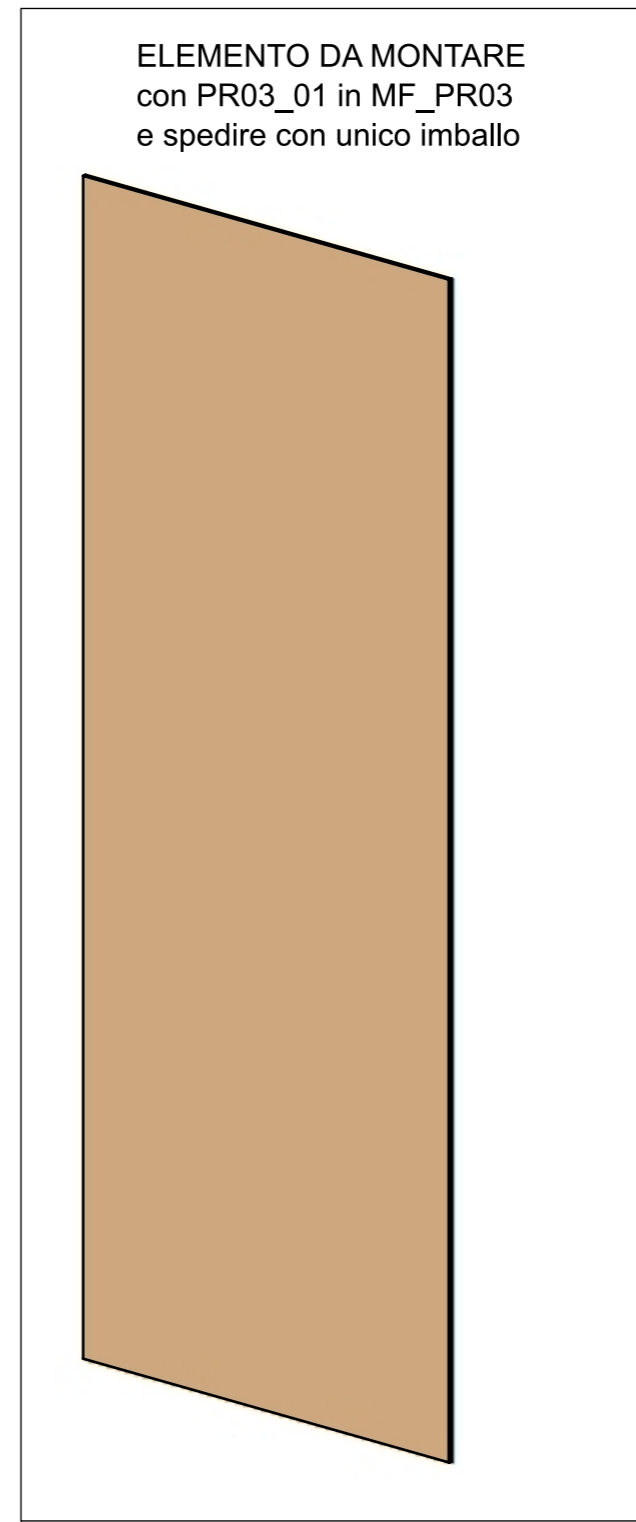
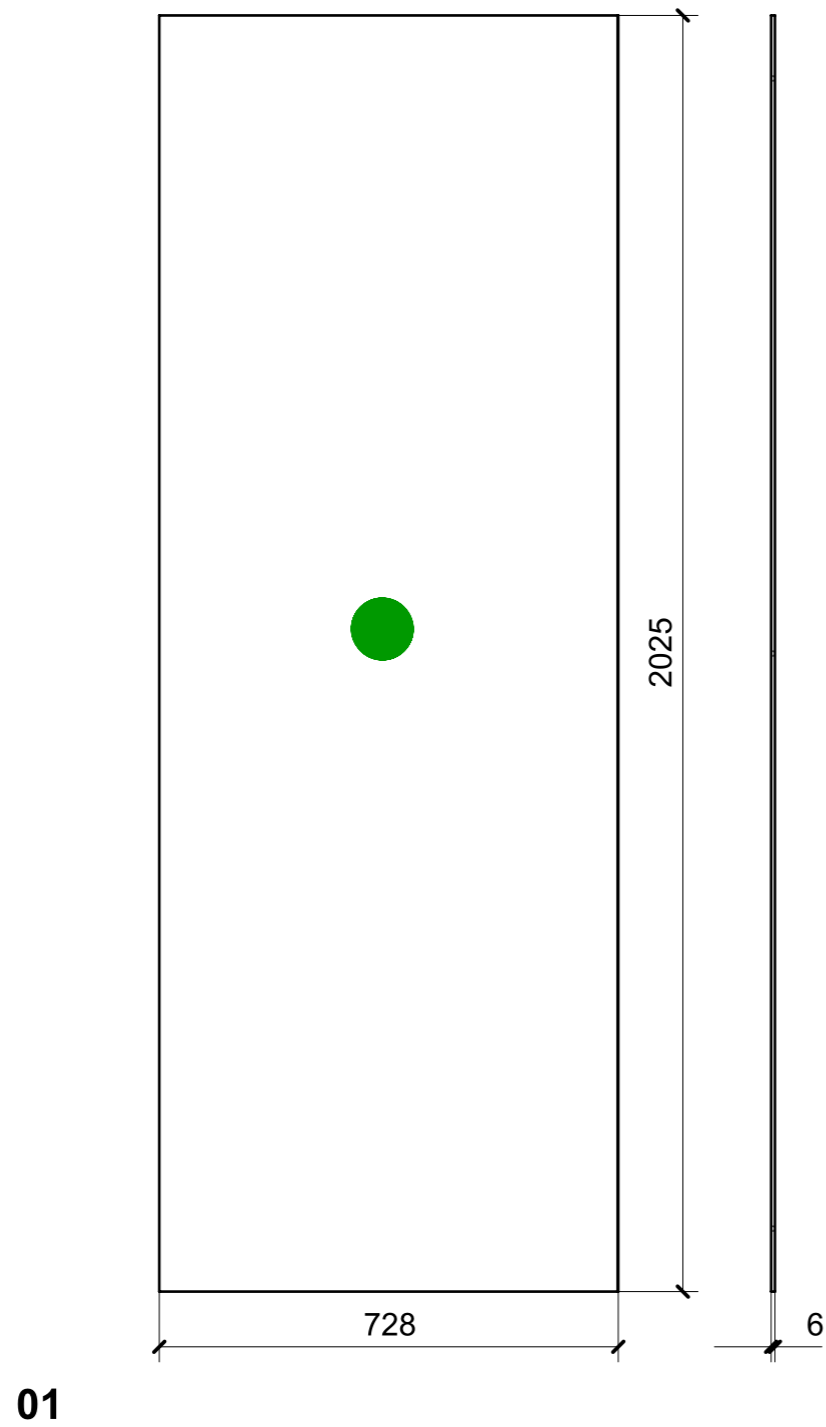

VERNICIATURA LASTRA/LACCATI:

● = VERNICIARE 1 LATO + FILI RASATI O BORDATI

NESSUN SIMBOLO = VERNICIARE 2 LATI + FILI RASATI O BORDATI

| LOCALE     | CODICE         | DESCRIZIONE COMPONENTE       | FINITURA                       | GR. |
|------------|----------------|------------------------------|--------------------------------|-----|
| PARATIE LD | MD321_R01_PR05 | PARATIA PORTA BAGNO ARMATORE | LAISTRA ALPI JAY STRIPED 12.35 | PTP |

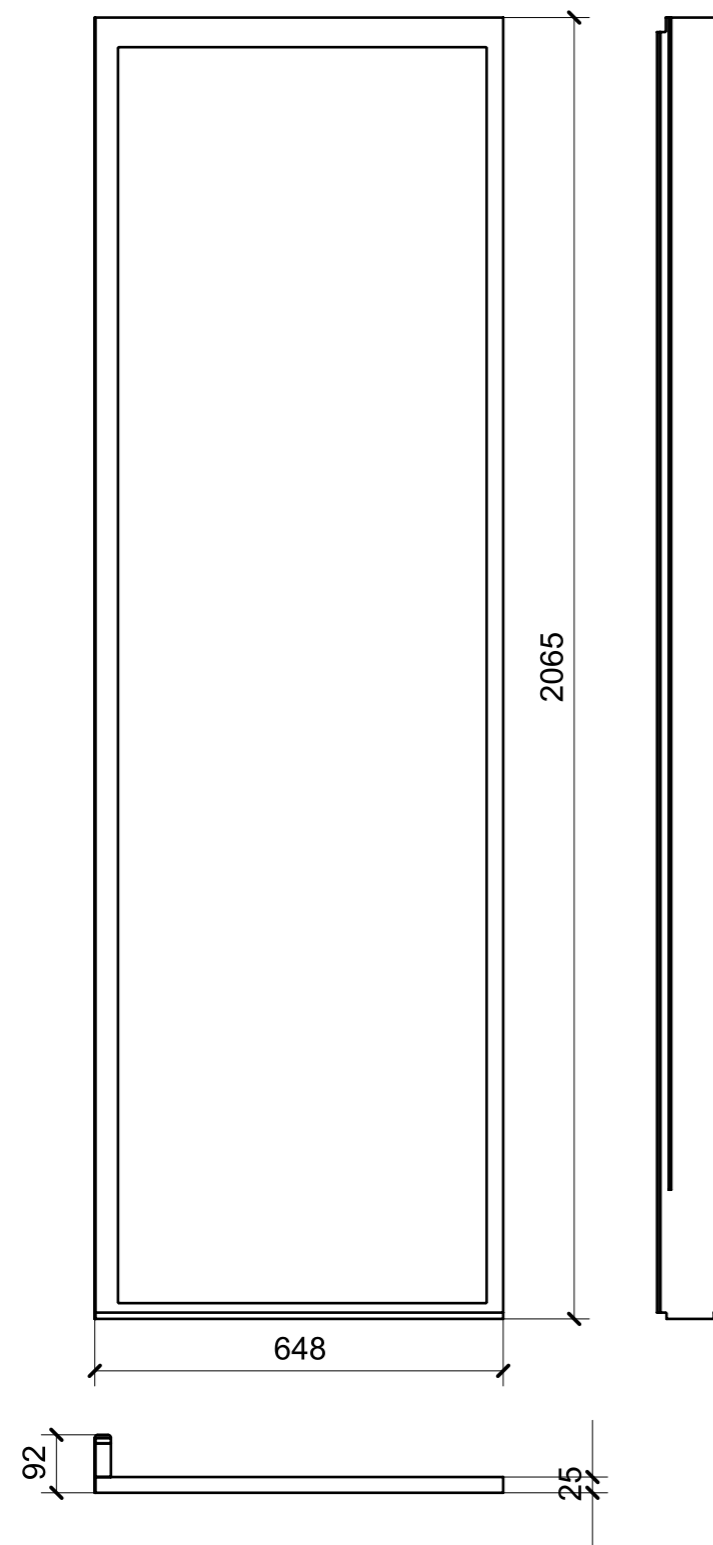

01

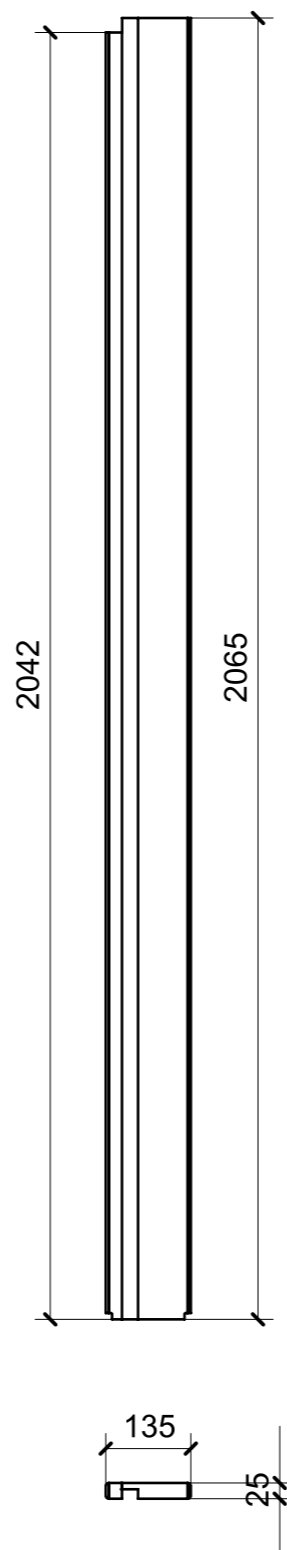

02

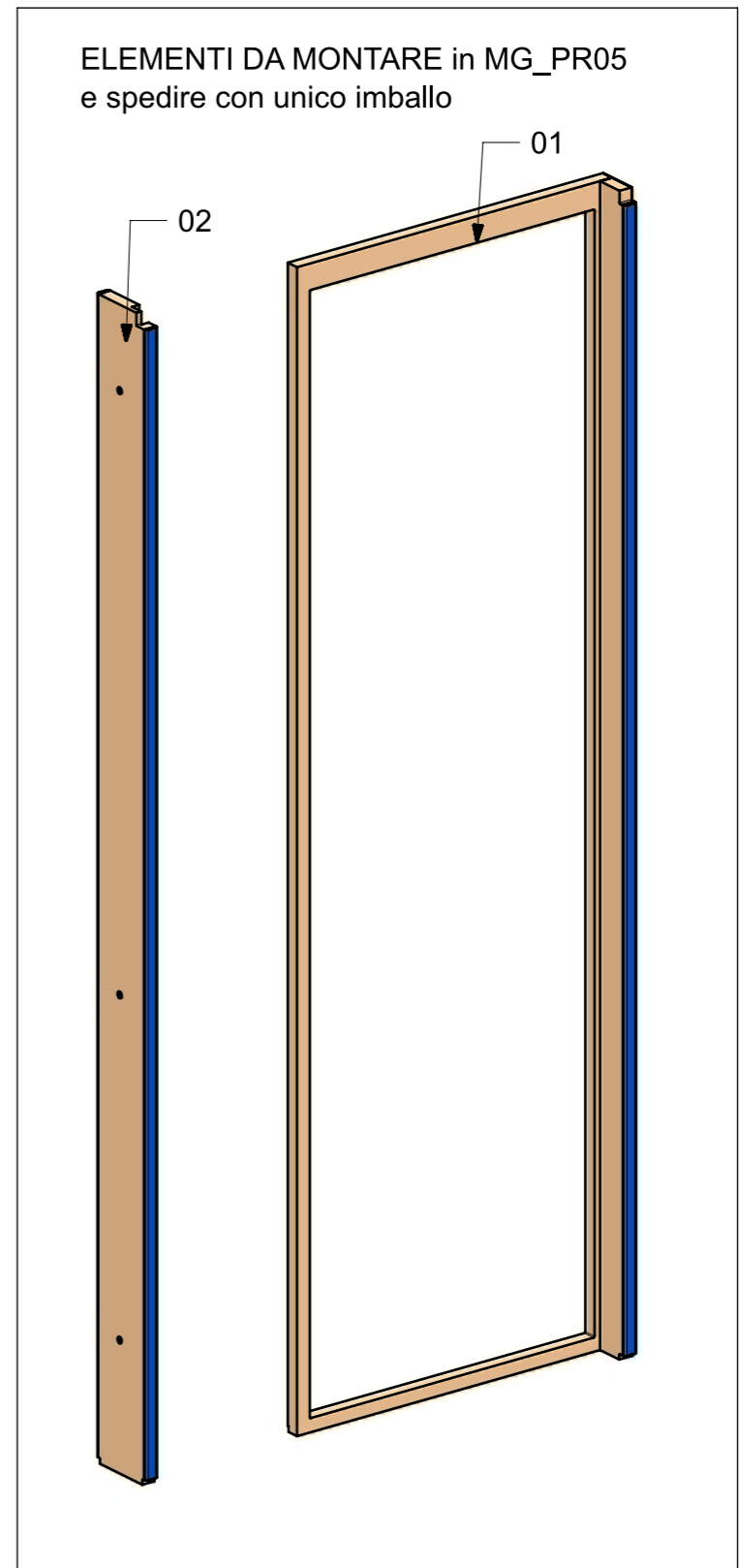

VERNICIATURA LASTRA/LACCATI:

● = VERNICIARE 1 LATO + FILI RASATI O BORDATI

NESSUN SIMBOLO = VERNICIARE 2 LATI + FILI RASATI O BORDATI

| LOCALE     | CODICE         | DESCRIZIONE COMPONENTE              | FINITURA                       | GR. |
|------------|----------------|-------------------------------------|--------------------------------|-----|
| PARATIE LD | MD321_R01_PR07 | PARATIA CENTRONAVE CABINA OSPITI DX | LAISTRA ALPI JAY STRIPED 12.35 | 2   |

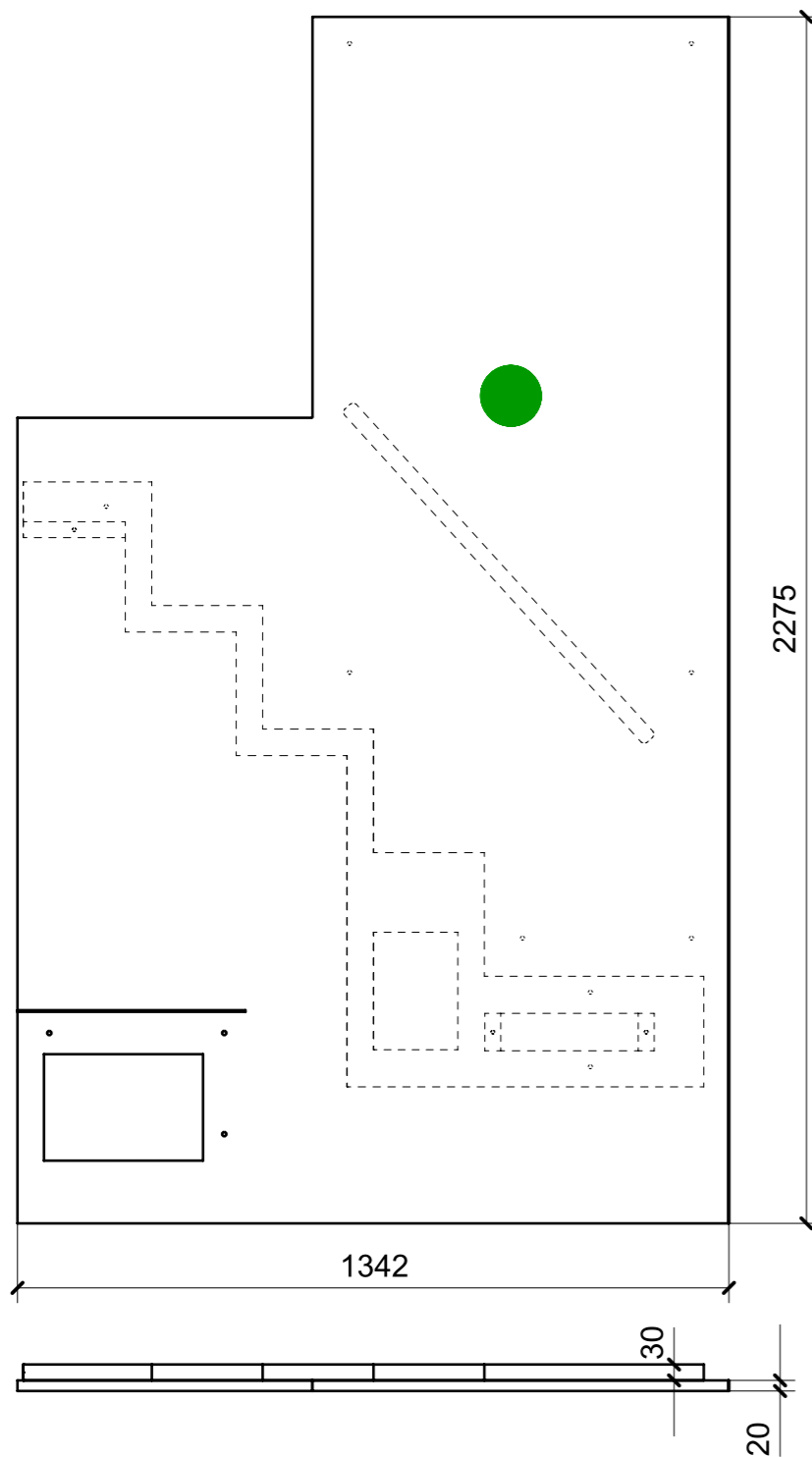

01

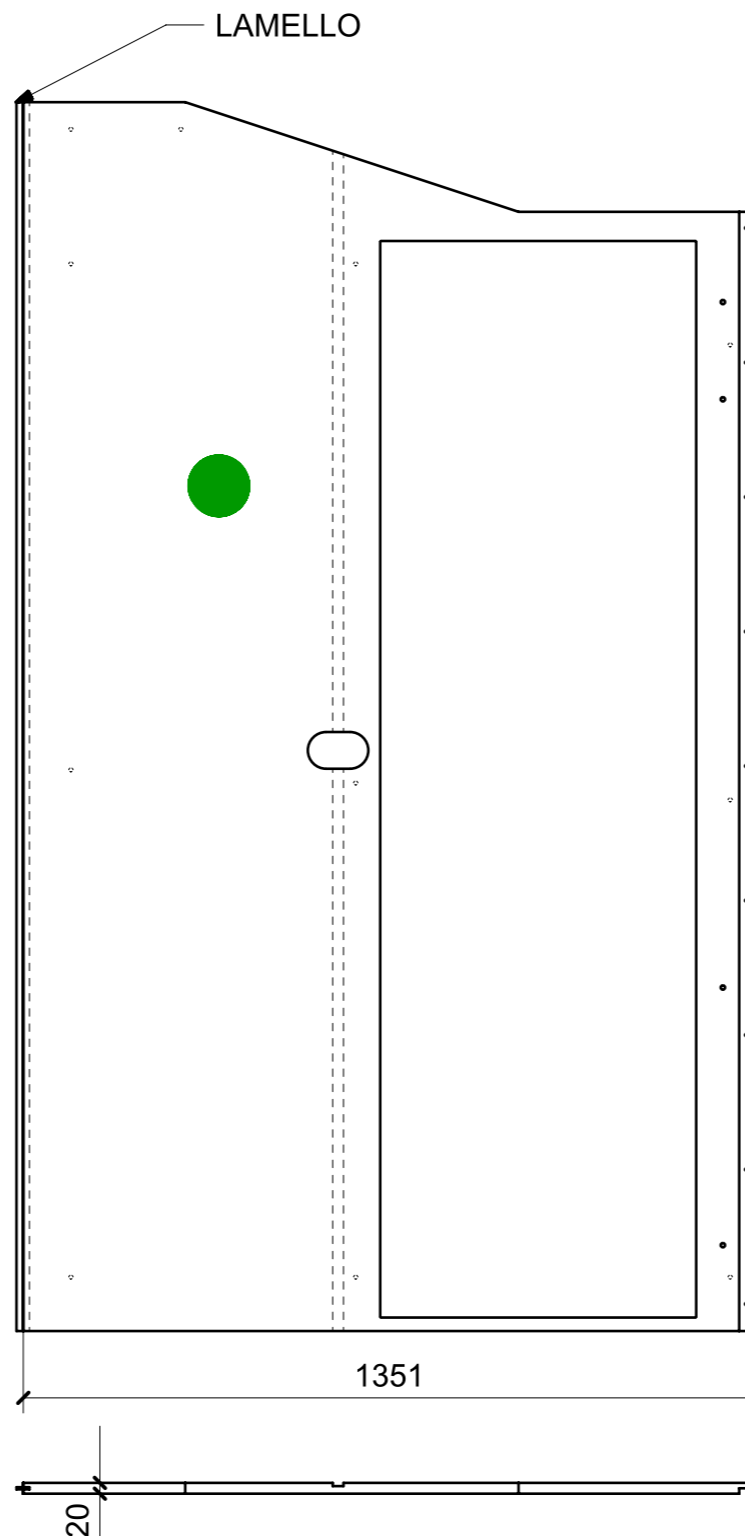

02

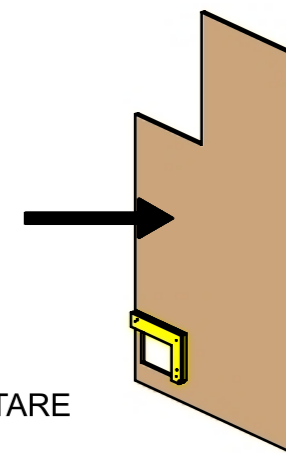

ELEMENTO DA MONTARE  
in MF\_PR07  
e spedire con unico imballo

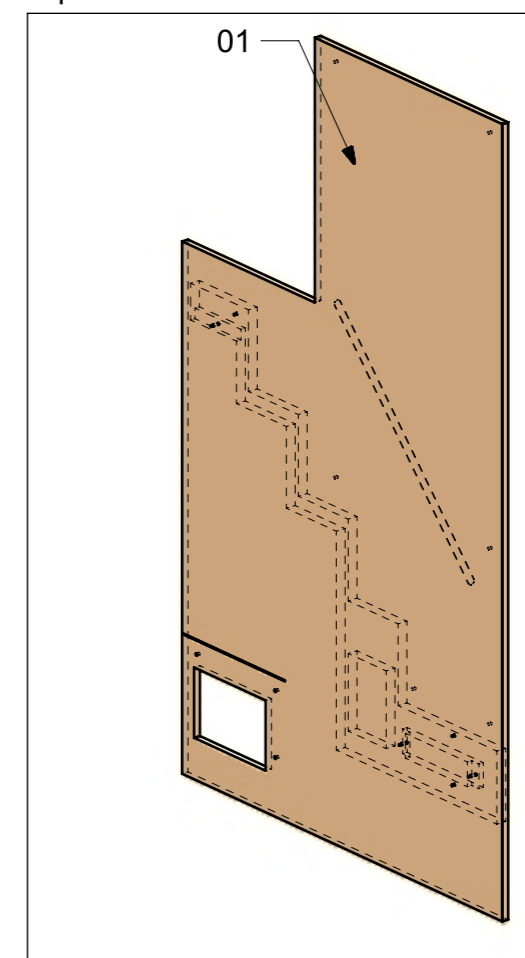

01

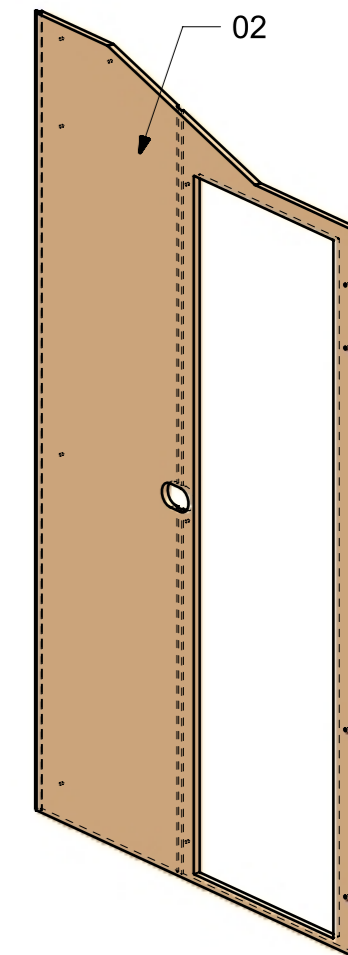

02

| FERRAMENTA                                     | QTY |
|--|-----|
| VITE 6MA X 20 TESTA BOMBATA NERA BHCS 00317092 | 3   |
| BUSSOLA 6MA X 10 FORO DIAM.8                   | 12  |

VERNICIATURA LASTRA/LACCATI:

● = VERNICIARE 1 LATO + FILI RASATI O BORDATI

NESSUN SIMBOLO = VERNICIARE 2 LATI + FILI RASATI O BORDATI

| LOCALE     | CODICE         | DESCRIZIONE COMPONENTE                 | FINITURA                      | GR. |
|------------|----------------|--|-------------------------------|-----|
| PARATIE LD | MD321_R01_PR08 | PARATIA INGRESSO BAGNO OSPITI DX POPPA | LASTRA ALPI JAY STRIPED 12.35 | 2   |

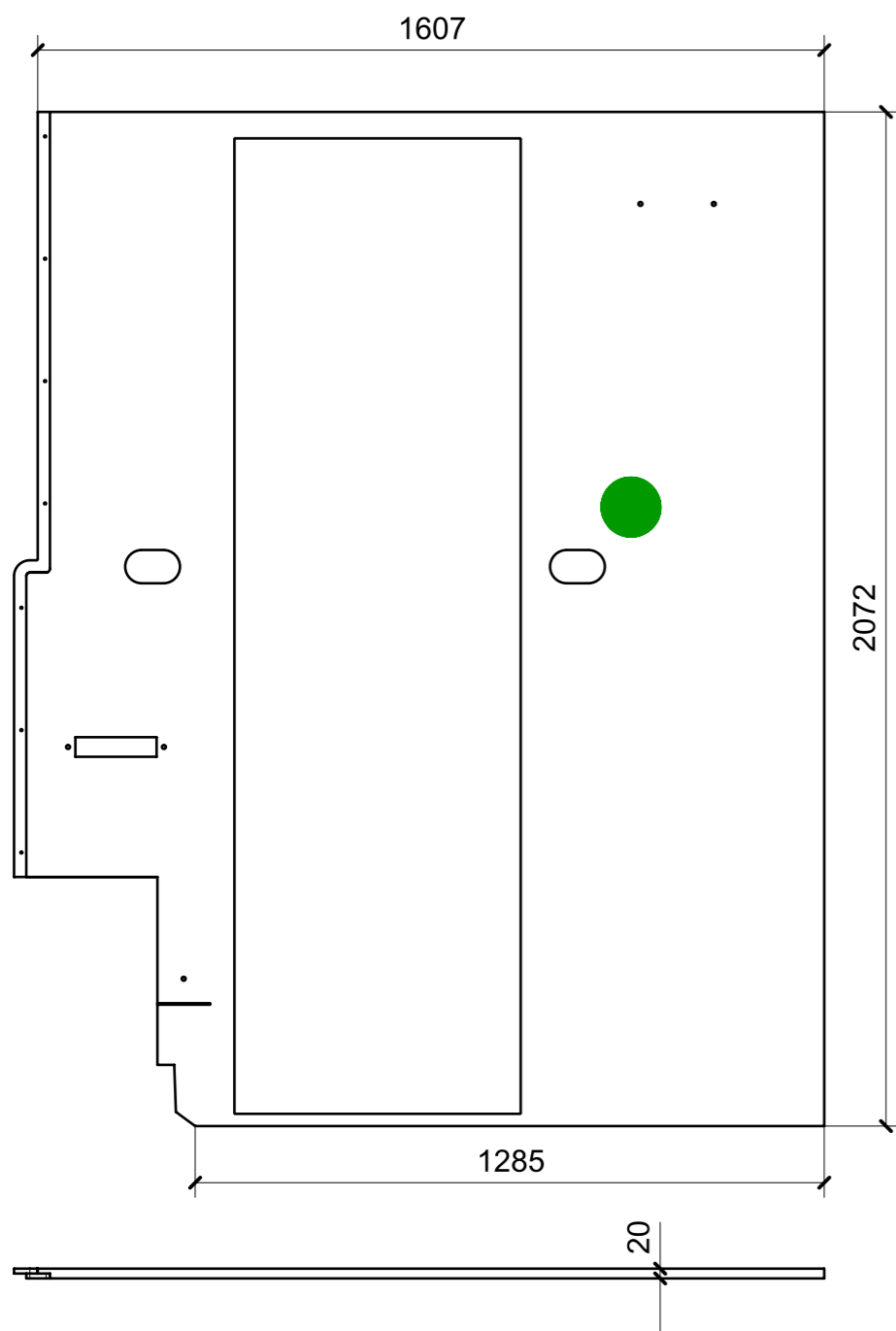

01

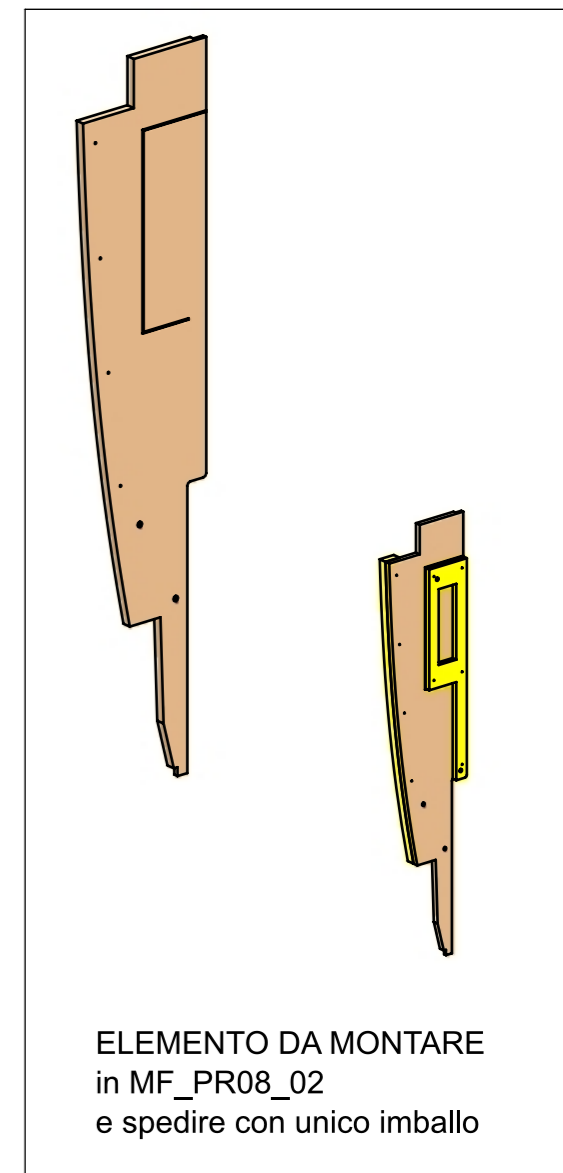
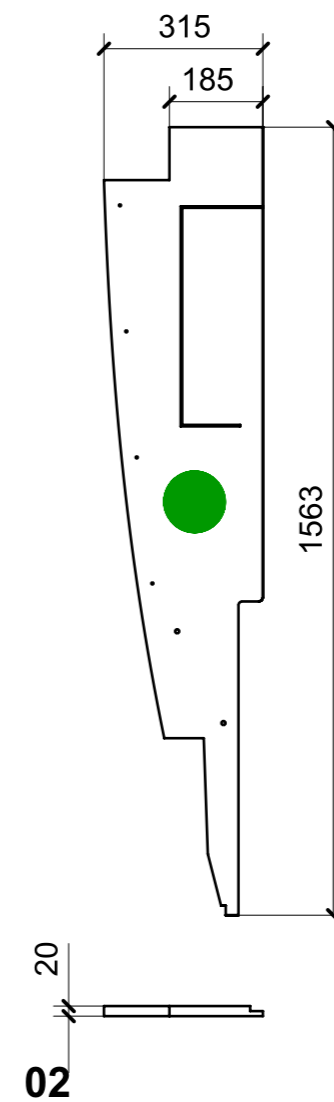
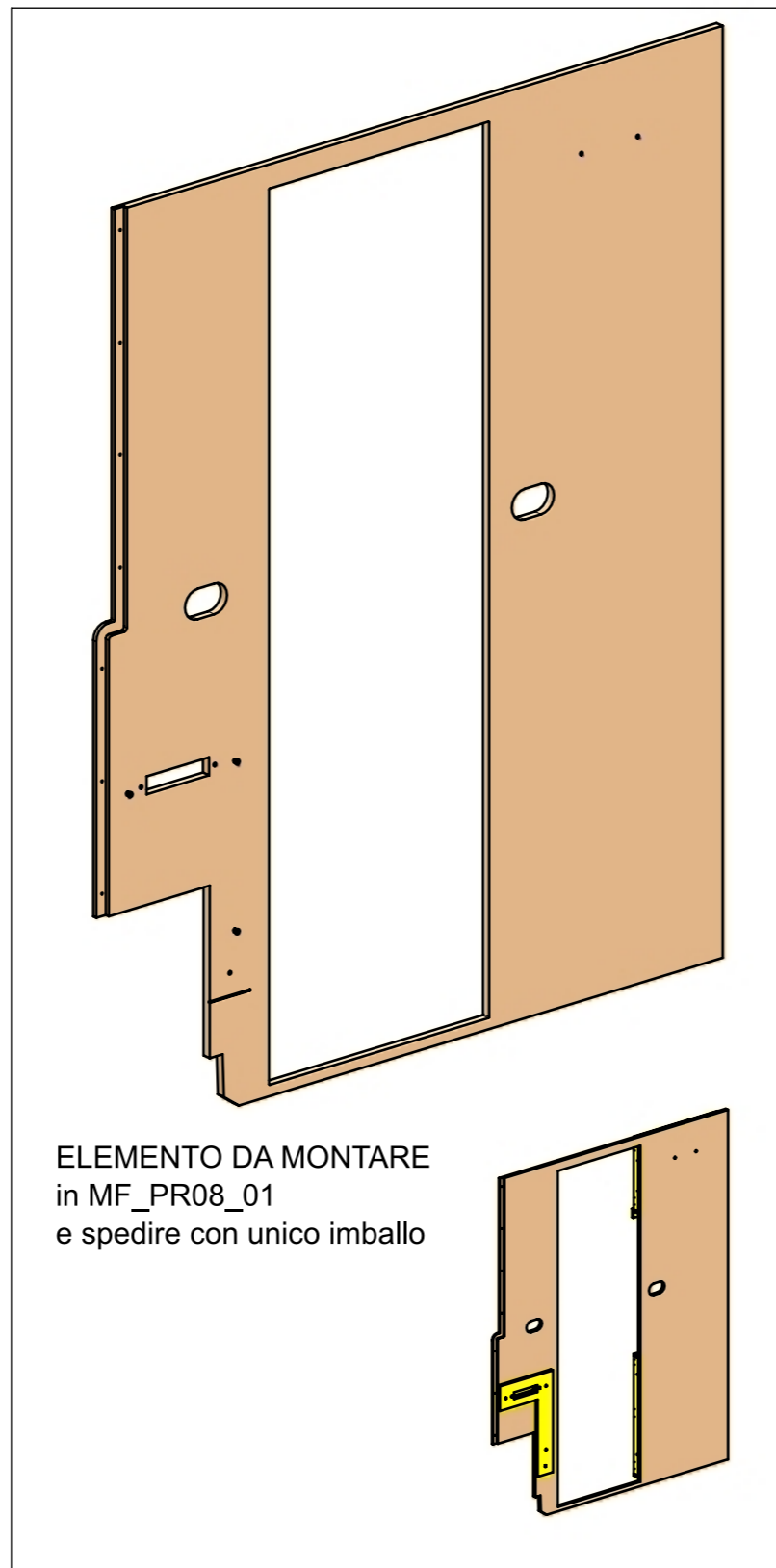

| FERRAMENTA                   | QTY |
|------------------------------|-----|
| VITE 6MA X 25 TESTA SVASATA  | 3   |
| VITE 6MA X 20 TESTA BOMBATA  | 8   |
| BUSSOLA 6MA X 10 FORO DIAM.8 | 18  |

VERNICIATURA LASTRA/LACCATI:

● = VERNICIARE 1 LATO + FILI RASATI O BORDATI

NESSUN SIMBOLO = VERNICIARE 2 LATI + FILI RASATI O BORDATI

| LOCALE     | CODICE         | DESCRIZIONE COMPONENTE             | FINITURA                                      | GR. |
|------------|----------------|------------------------------------|---|-----|
| PARATIE LD | MD321_R01_PR09 | PARATIA BAGNO OSPITI DX CENTRONAVE | LASTRA ALPI JAY STRIPED 12.35\ LAMINATO BEIGE | PTP |

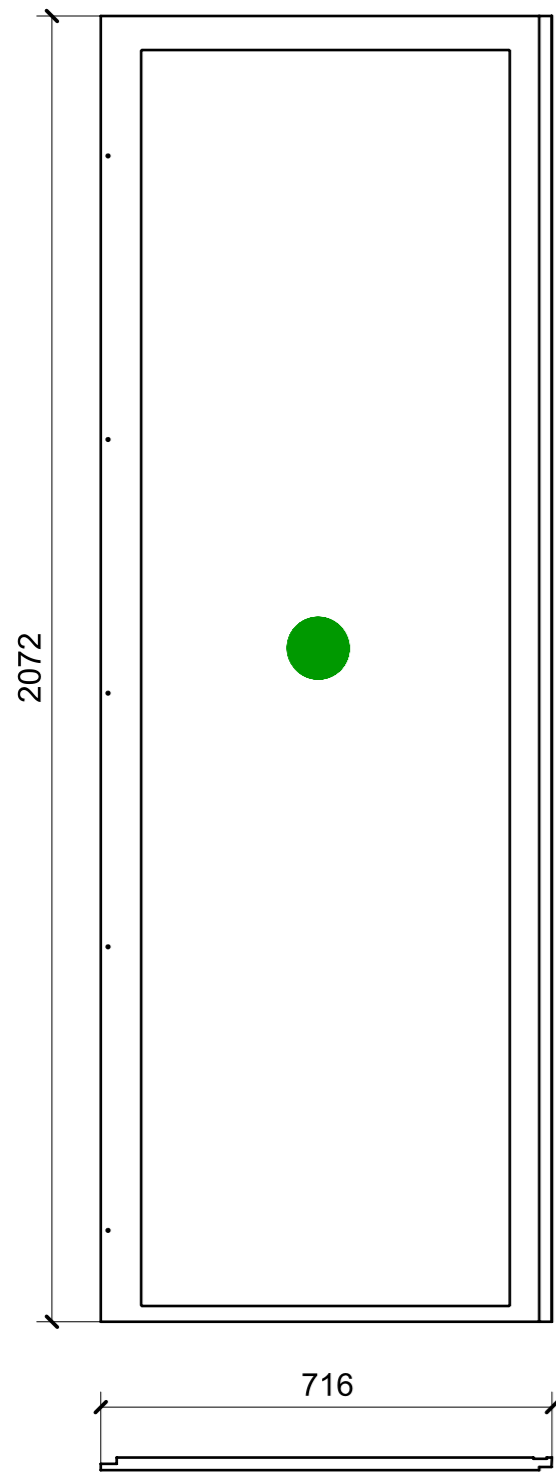

01

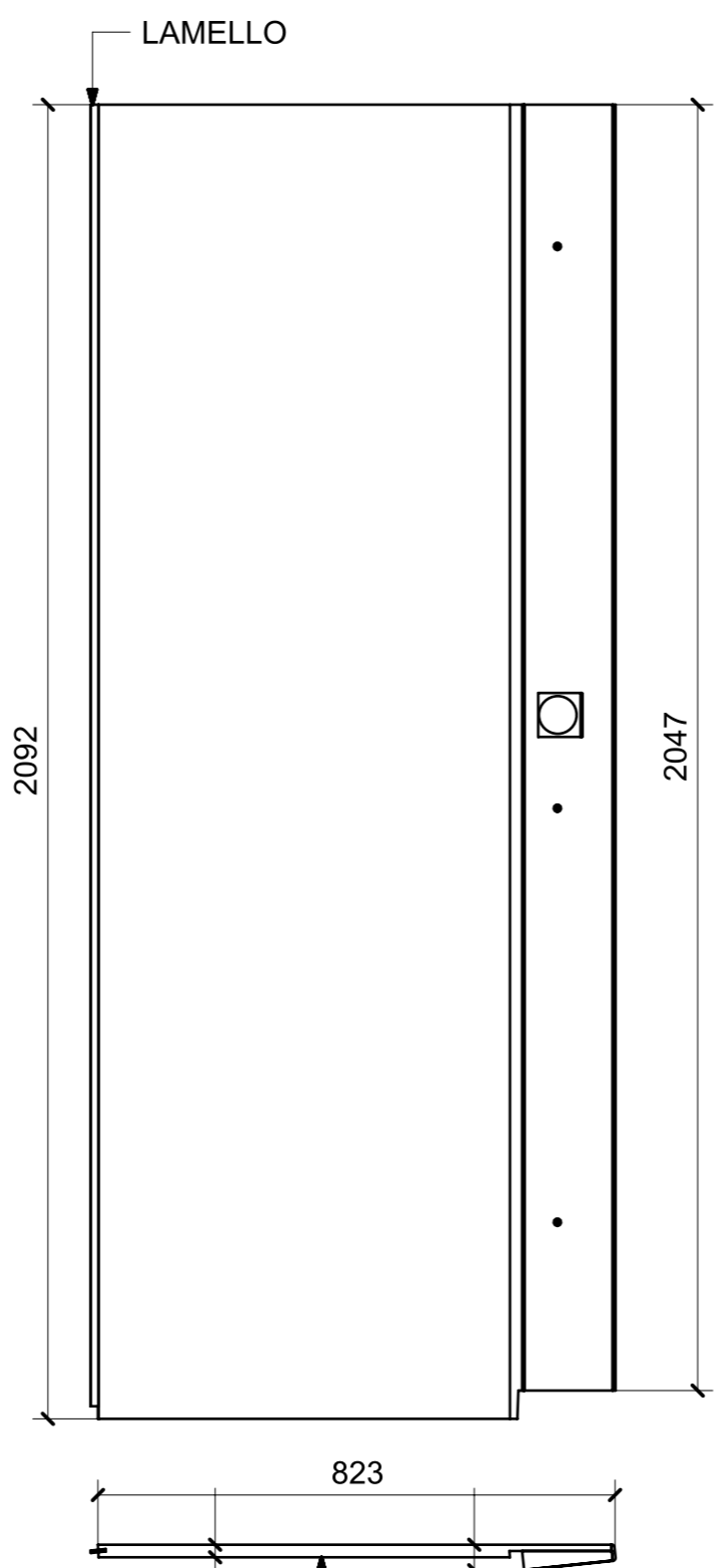

02

LATO LAMINATO BEIGE

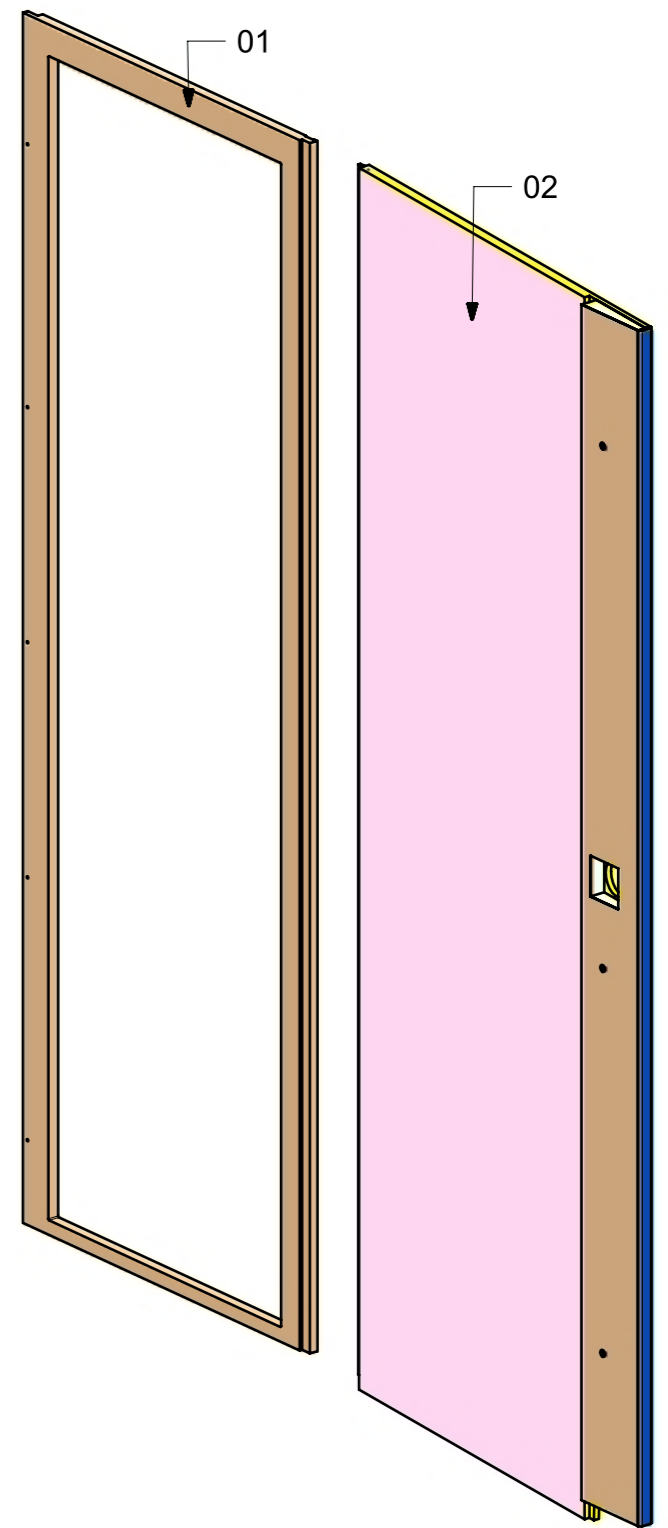

| FERRAMENTA                   | QTY |
|------------------------------|-----|
| BUSSOLA 6MA X 10 FORO DIAM.8 | 3   |

VERNICIATURA LASTRA/LACCATI:

● = VERNICIARE 1 LATO + FILI RASATI O BORDATI

NESSUN SIMBOLO = VERNICIARE 2 LATI + FILI RASATI O BORDATI

| LOCALE     | CODICE         | DESCRIZIONE COMPONENTE | FINITURA                       | GR. |
|------------|----------------|------------------------|--------------------------------|-----|
| PARATIE LD | MD321_R01_PR11 | PARATIA BAGNO VIP PRUA | LAISTRA ALPI JAY STRIPED 12.35 | 2   |

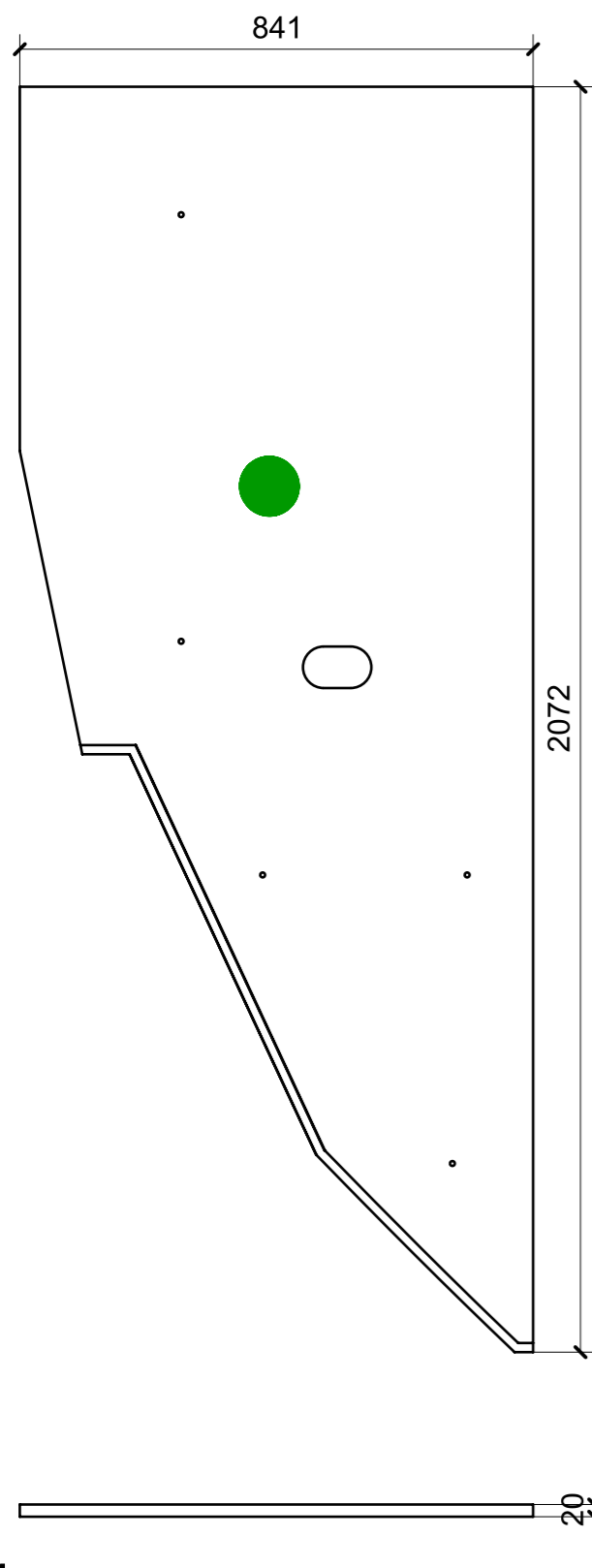

01

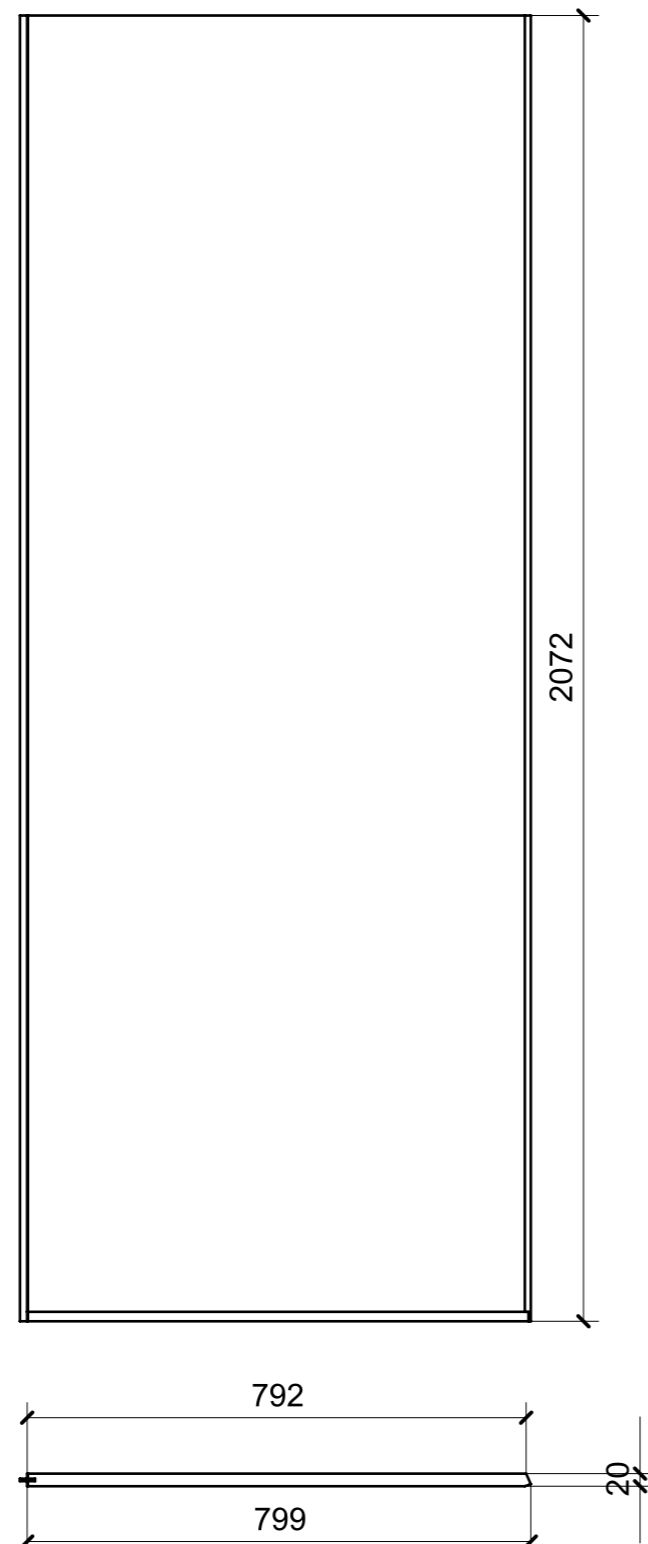

02

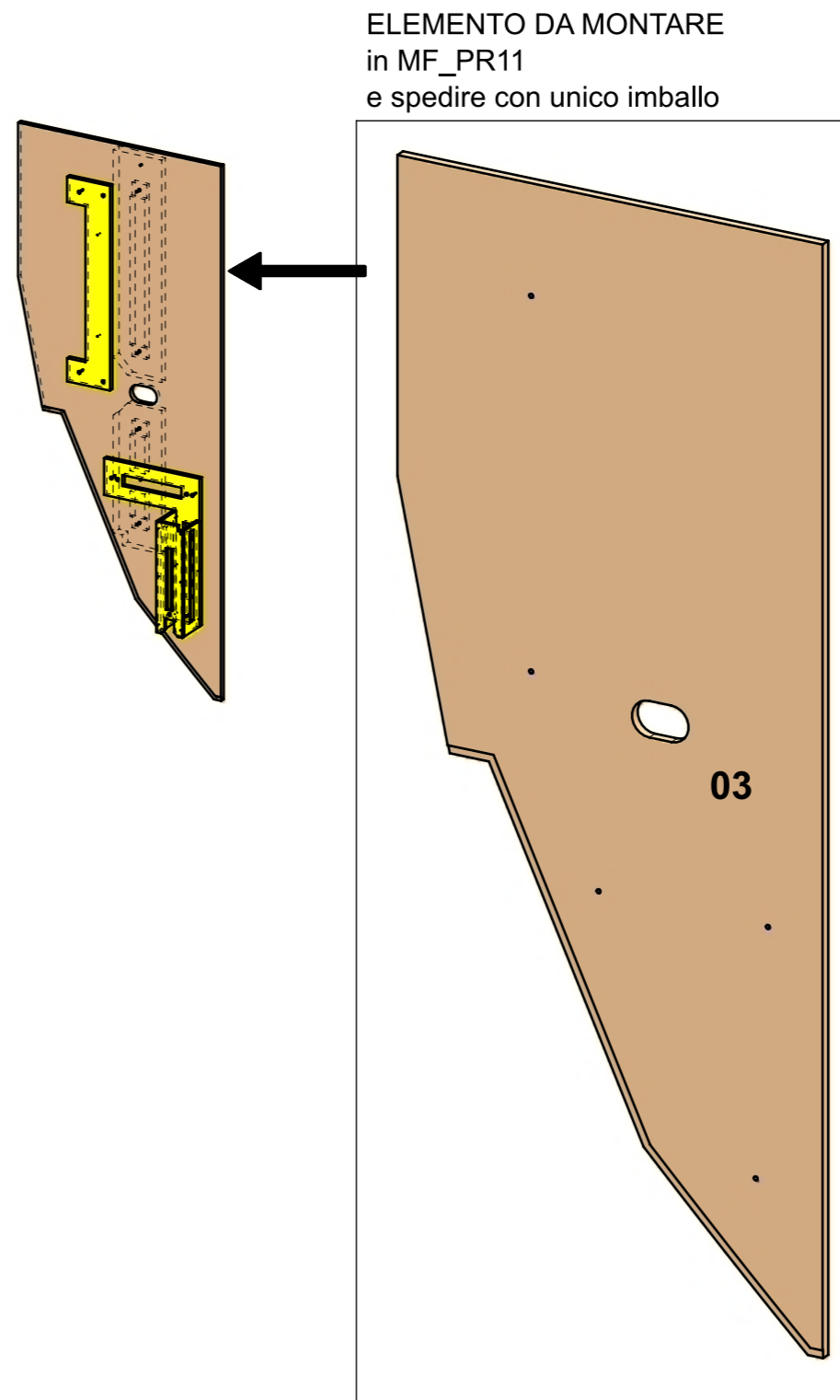

| FERRAMENTA                   | QTY |
|------------------------------|-----|
| VITE 6MA X 25 TESTA SVASATA  | 5   |
| VITE 6MA X 20 TESTA BOMBATA  | 4   |
| BUSSOLA 6MA X 10 FORO DIAM.8 | 16  |

VERNICIATURA LASTRA/LACCATI:

● = VERNICIARE 1 LATO + FILI RASATI O BORDATI

NESSUN SIMBOLO = VERNICIARE 2 LATI + FILI RASATI O BORDATI

| LOCALE     | CODICE         | DESCRIZIONE COMPONENTE       | FINITURA                                      | GR. |
|------------|----------------|------------------------------|---|-----|
| PARATIE LD | MD321_R01_PR12 | PARATIA BAGNO VIP CENTRONAVE | LASTRA ALPI JAY STRIPED 12.35\ LAMINATO BEIGE | PTP |

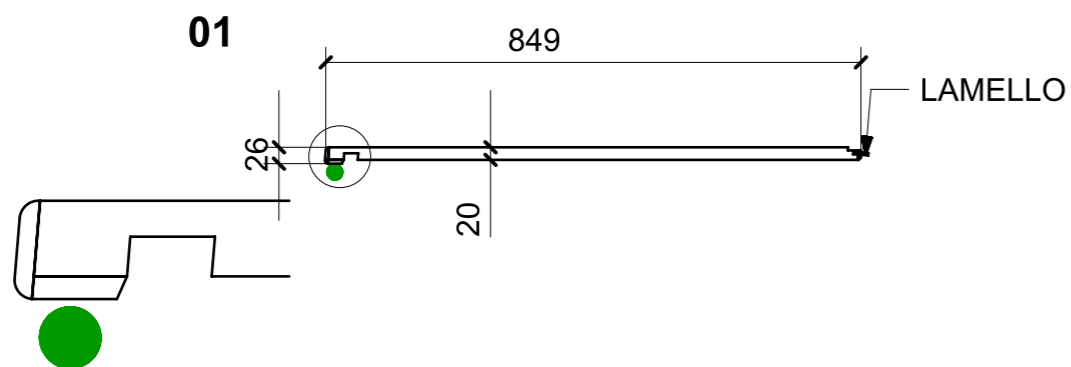
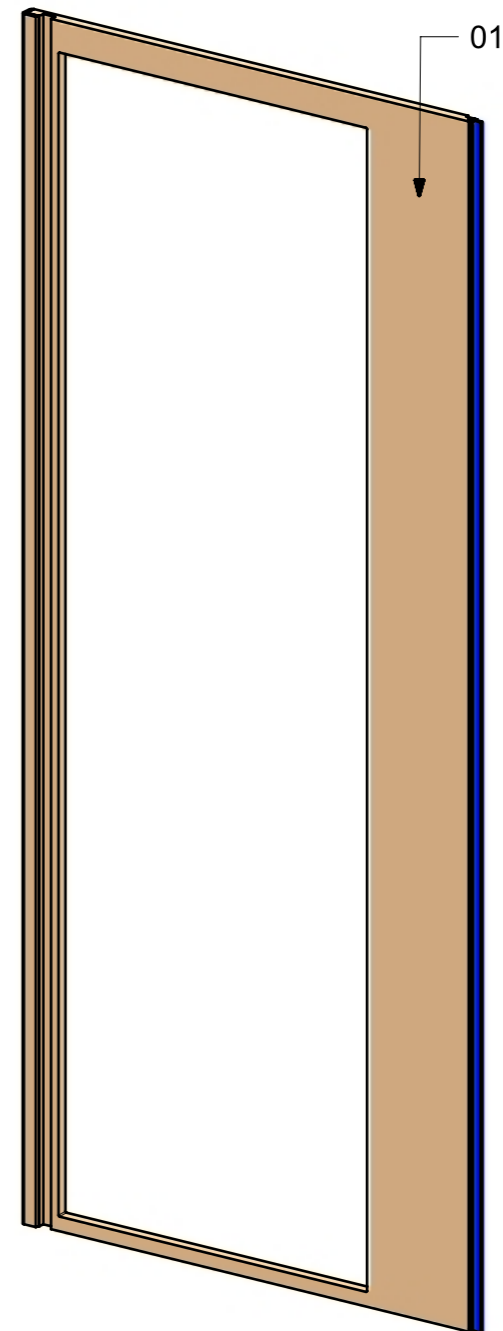
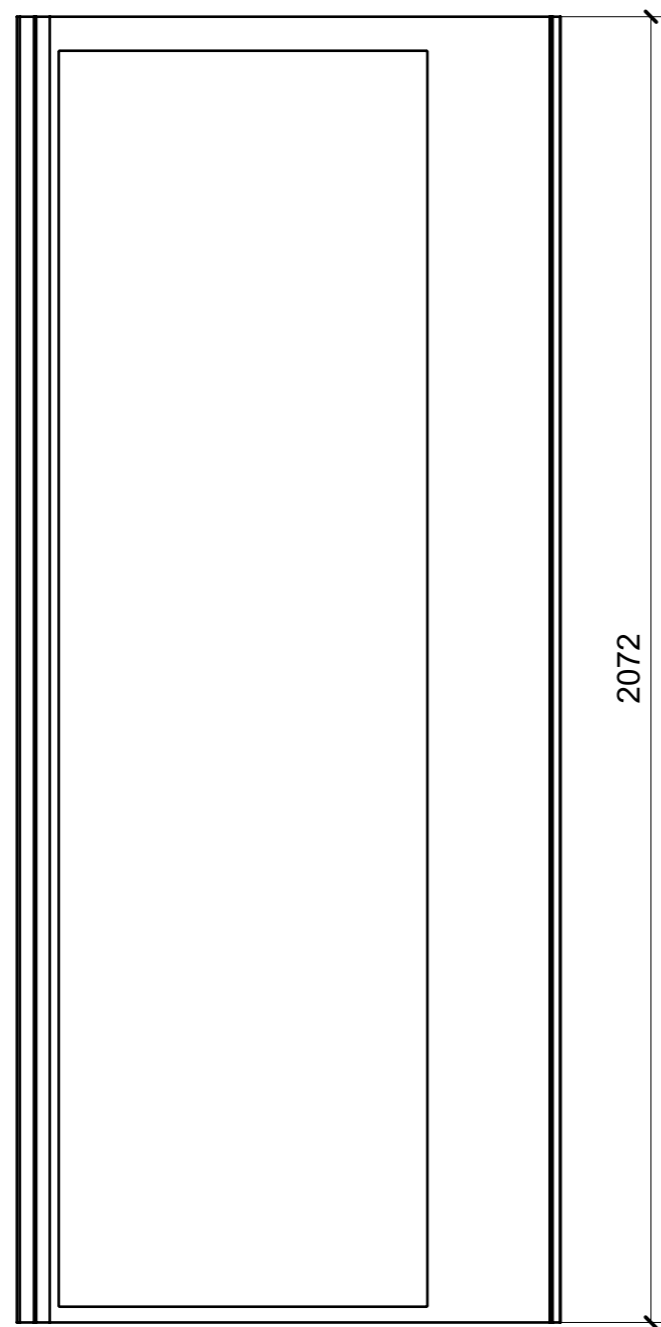

VERNICIATURA LASTRA/LACCATI:

● = VERNICIARE 1 LATO + FILI RASATI O BORDATI

NESSUN SIMBOLO = VERNICIARE 2 LATI + FILI RASATI O BORDATI

| LOCALE     | CODICE         | DESCRIZIONE COMPONENTE          | FINITURA                                      | GR. |
|------------|----------------|---------------------------------|---|-----|
| PARATIE LD | MD321_R01_PR14 | PARATIA BAGNO VIP DOCCIA_LAVABO | LASTRA ALPI JAY STRIPED 12.35\ LAMINATO BEIGE | 2   |

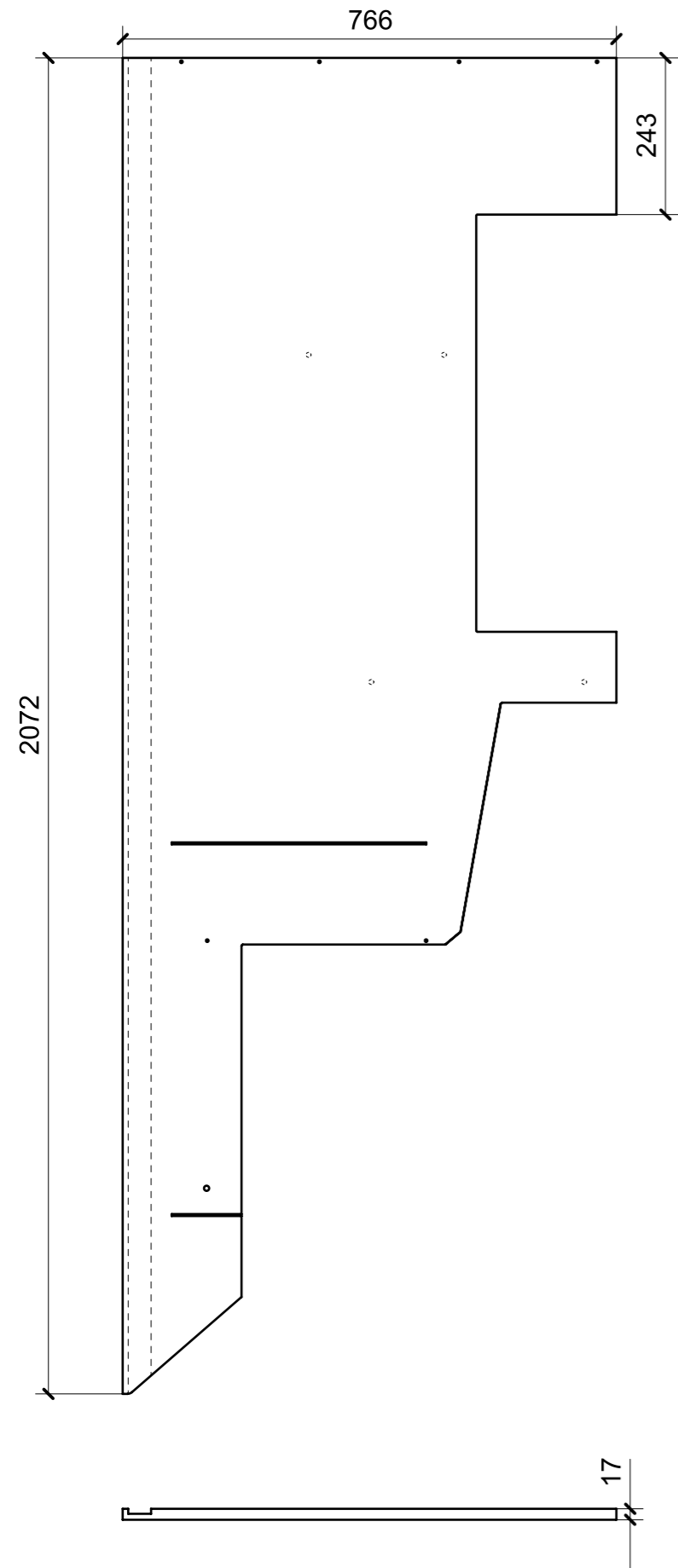

01



04

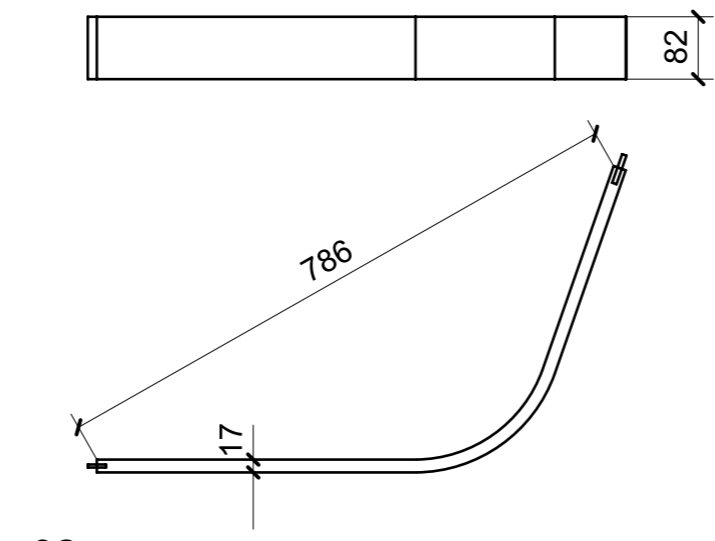

02

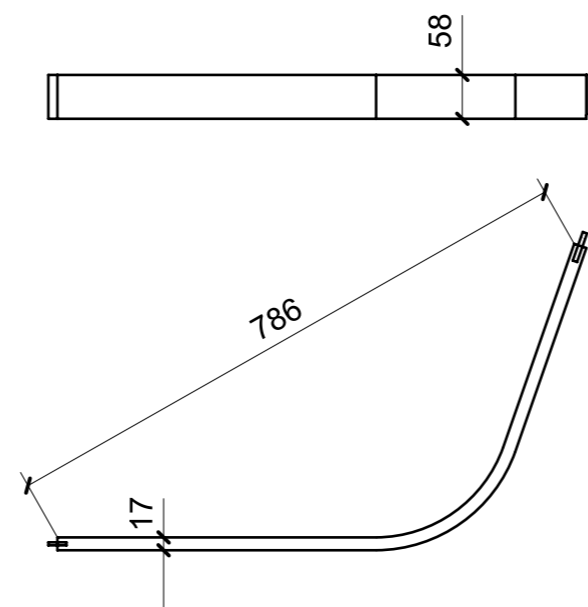

03



ELEMENTI DA MONTARE  
in MF\_PR14  
e spedire con unico imballo

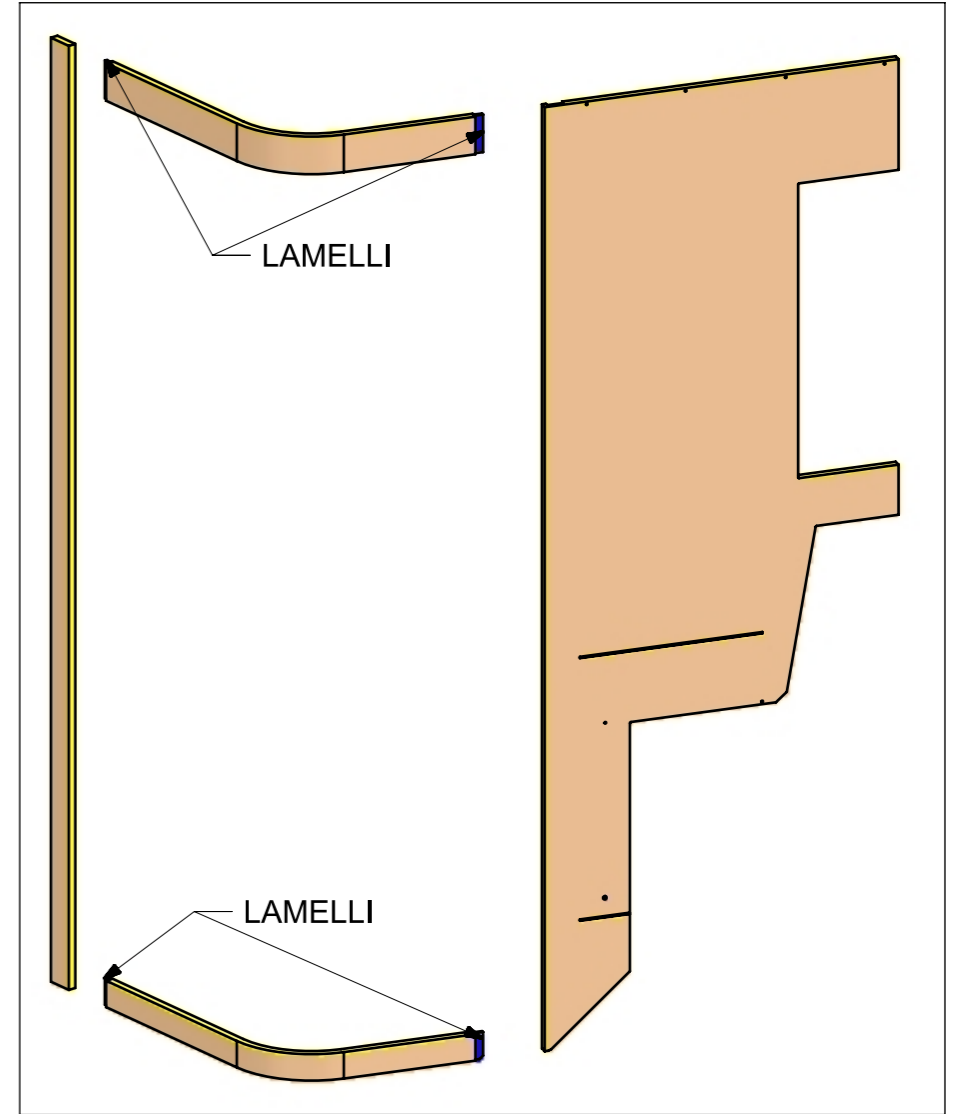

| FERRAMENTA                   | QTY |
|------------------------------|-----|
| VITE 6MA X 25 TESTA SVASATA  | 1   |
| BUSSOLA 6MA X 10 FORO DIAM.8 | 5   |
| VITE 6MA X 20 TESTA BOMBATA  | 4   |

VERNICIATURA LASTRA/LACCATI:  
● = VERNICIARE 1 LATO + FILI RASATI O BORDATI      NESSUN SIMBOLO = VERNICIARE 2 LATI + FILI RASATI O BORDATI

| LOCALE     | CODICE         | DESCRIZIONE COMPONENTE  | FINITURA                                     | GR. |
|------------|----------------|-------------------------|--|-----|
| PARATIE LD | MD321_R01_PR15 | PARATIA BAGNO VIP POPPA | LASTRA ALPI JAY STRIPED 12.35/LAMINATO BEIGE | PTP |

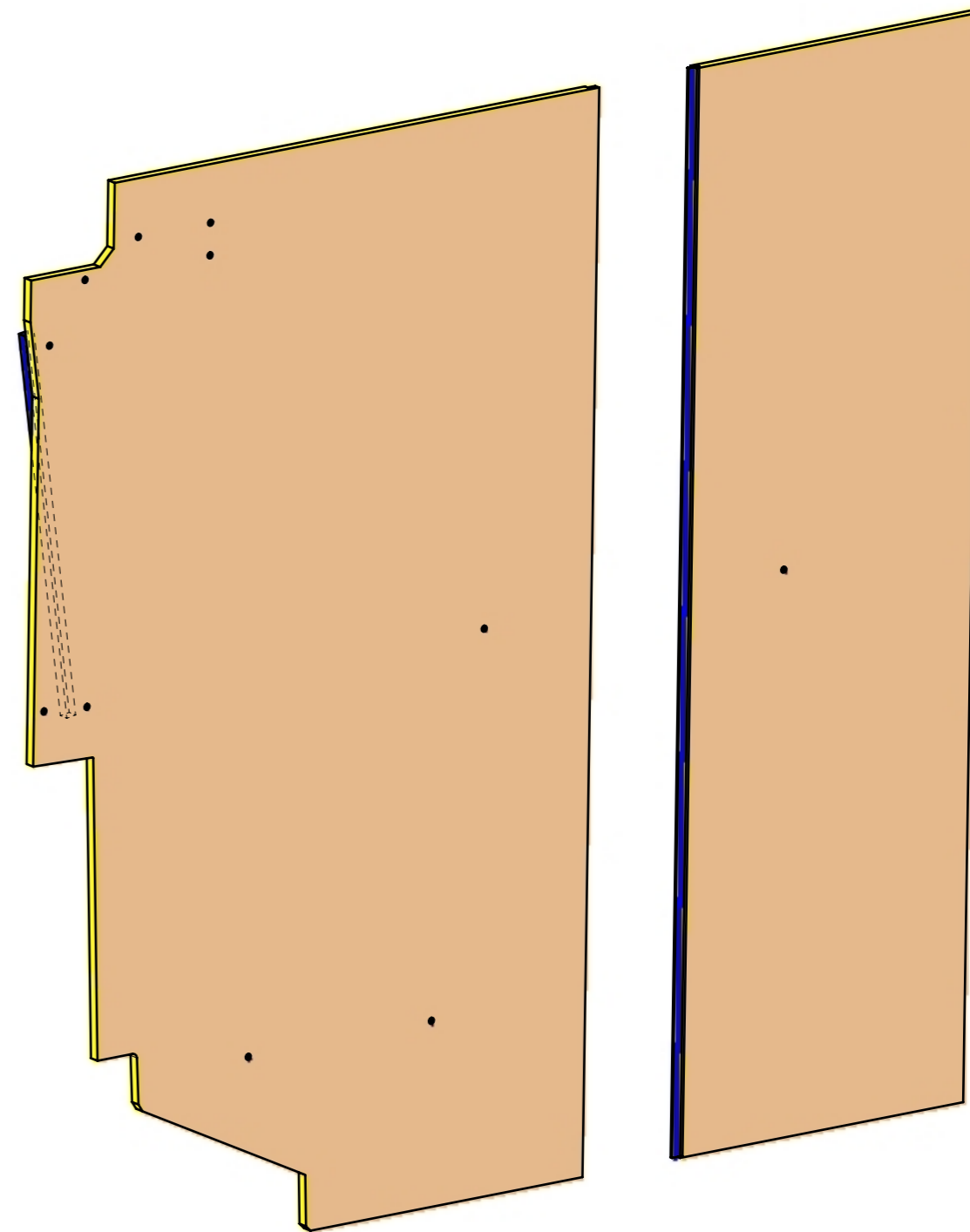
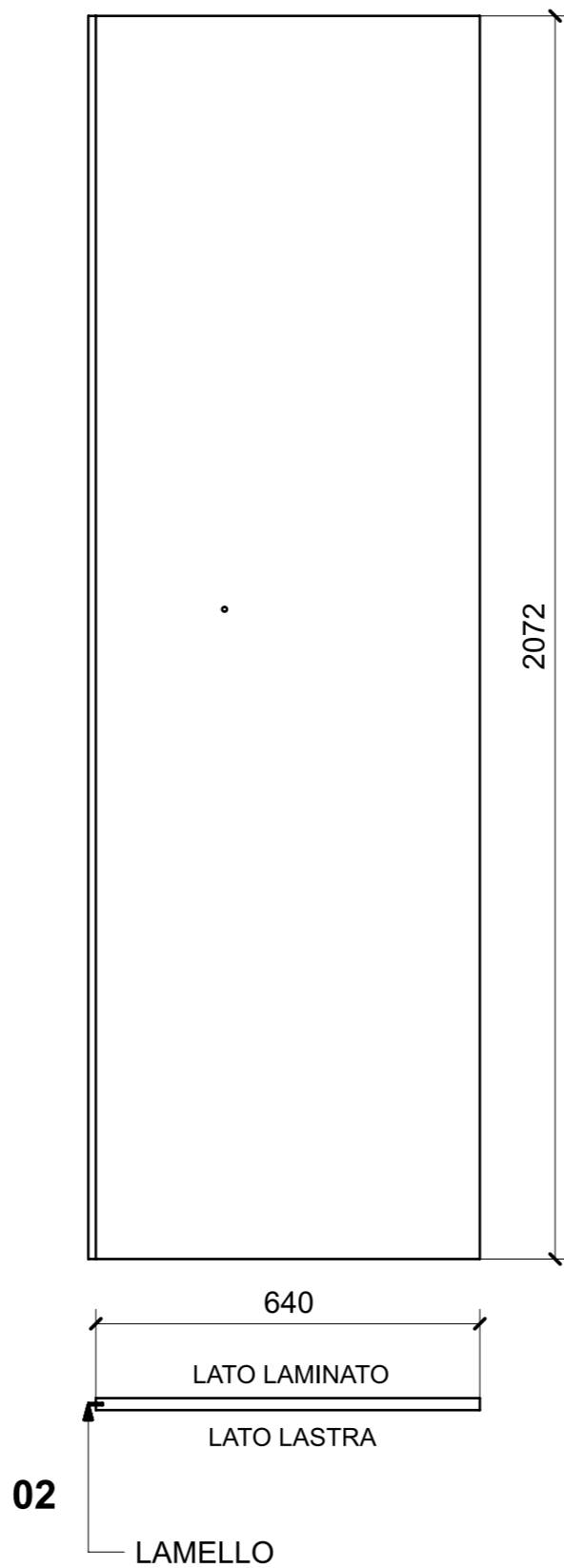
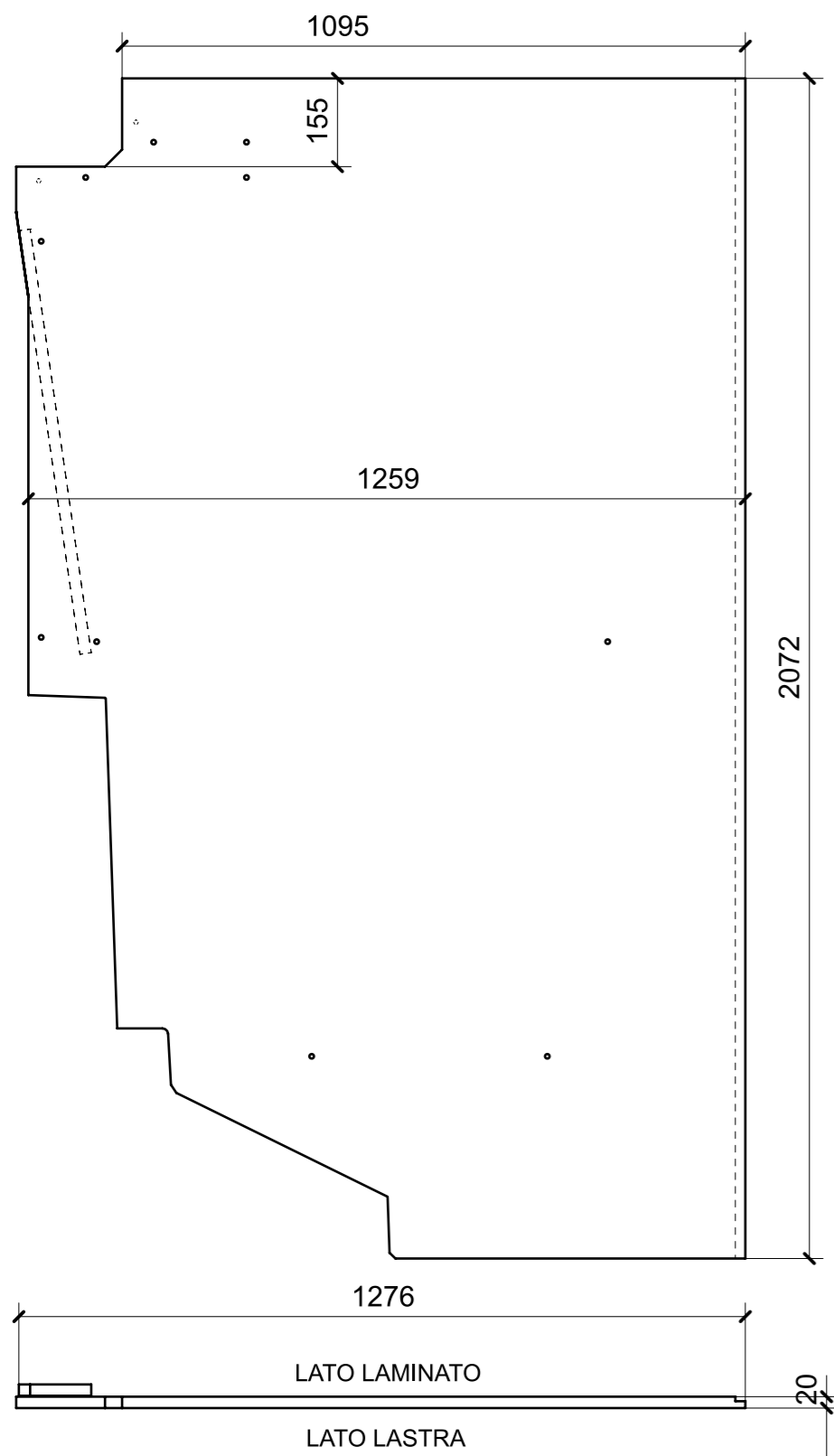

| FERRAMENTA                   | QTY |
|------------------------------|-----|
| BUSSOLA 6MA X 10 FORO DIAM.8 | 13  |

VERNICIATURA LASTRA/LACCATI:

● = VERNICIARE 1 LATO + FILI RASATI O BORDATI

NESSUN SIMBOLO = VERNICIARE 2 LATI + FILI RASATI O BORDATI

| LOCALE     | CODICE         | DESCRIZIONE COMPONENTE             | FINITURA                      | GR. |
|------------|----------------|------------------------------------|-------------------------------|-----|
| PARATIE LD | MD321_R01_PR16 | PARATI CABINA OSPITI SX CENTRONAVE | LASTRA ALPI JAY STRIPED 12.35 | 2   |

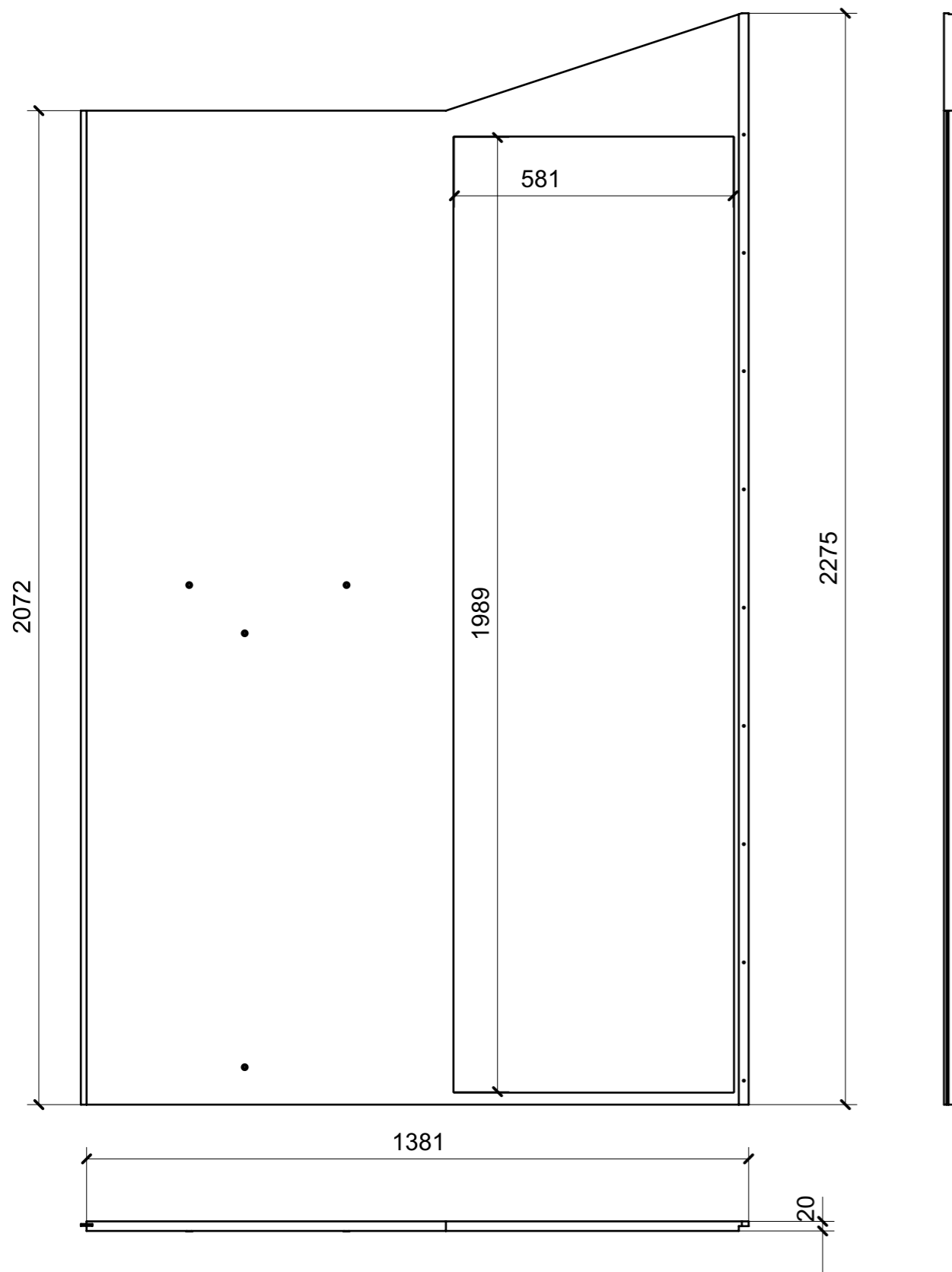

01

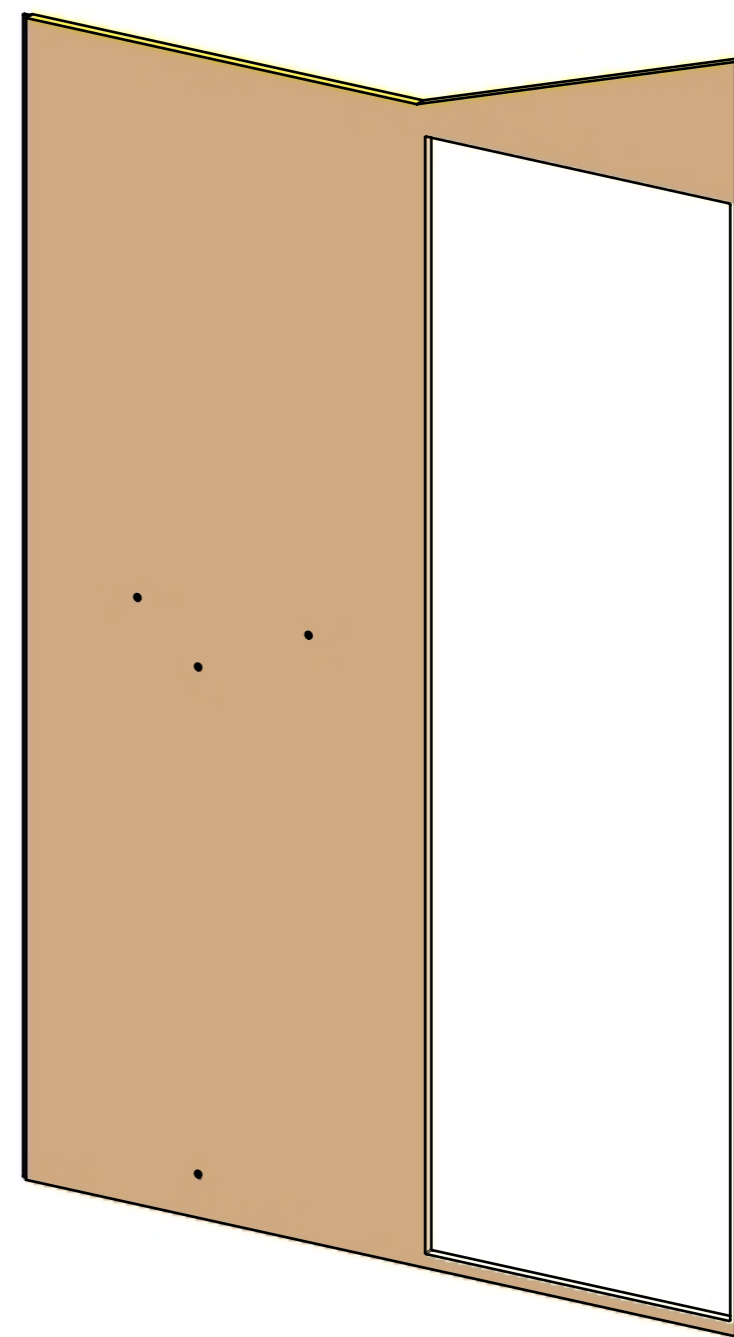

| FERRAMENTA                   | QTY |
|------------------------------|-----|
| BUSSOLA 6MA X 10 FORO DIAM.8 | 4   |

VERNICIATURA LASTRA/LACCATI:

● = VERNICIARE 1 LATO + FILI RASATI O BORDATI

NESSUN SIMBOLO = VERNICIARE 2 LATI + FILI RASATI O BORDATI

| LOCALE     | CODICE         | DESCRIZIONE COMPONENTE         | FINITURA                      | GR. |
|------------|----------------|--------------------------------|-------------------------------|-----|
| PARATIE LD | MD321_R01_PR17 | PARATIA CABINA OSPITI SX CURVA | LASTRA ALPI JAY STRIPED 12.35 | PTP |

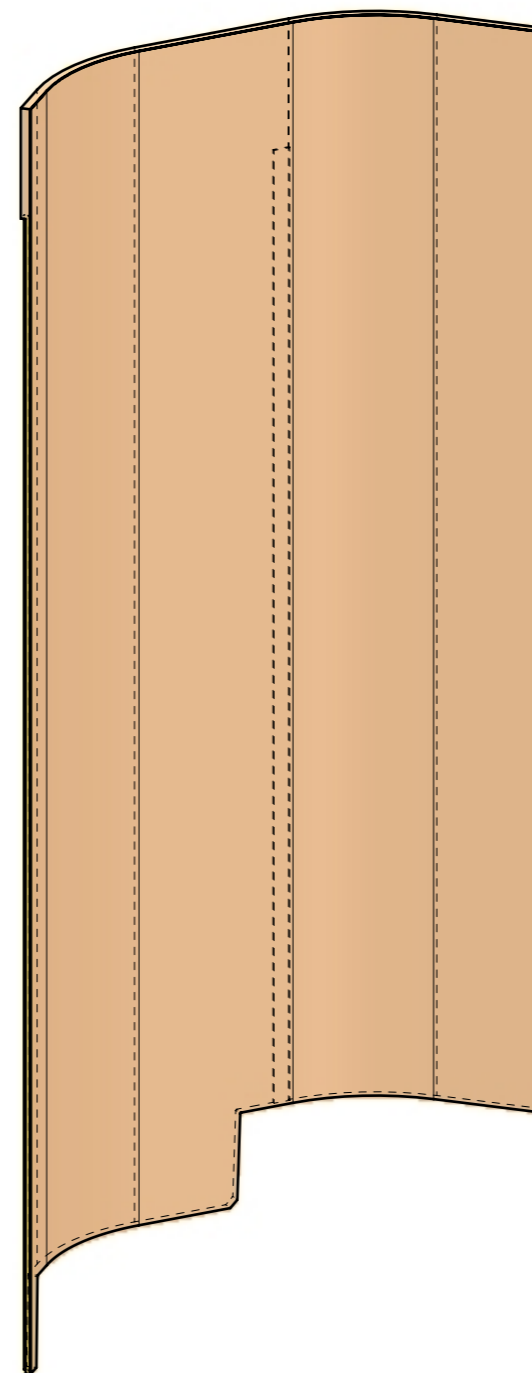
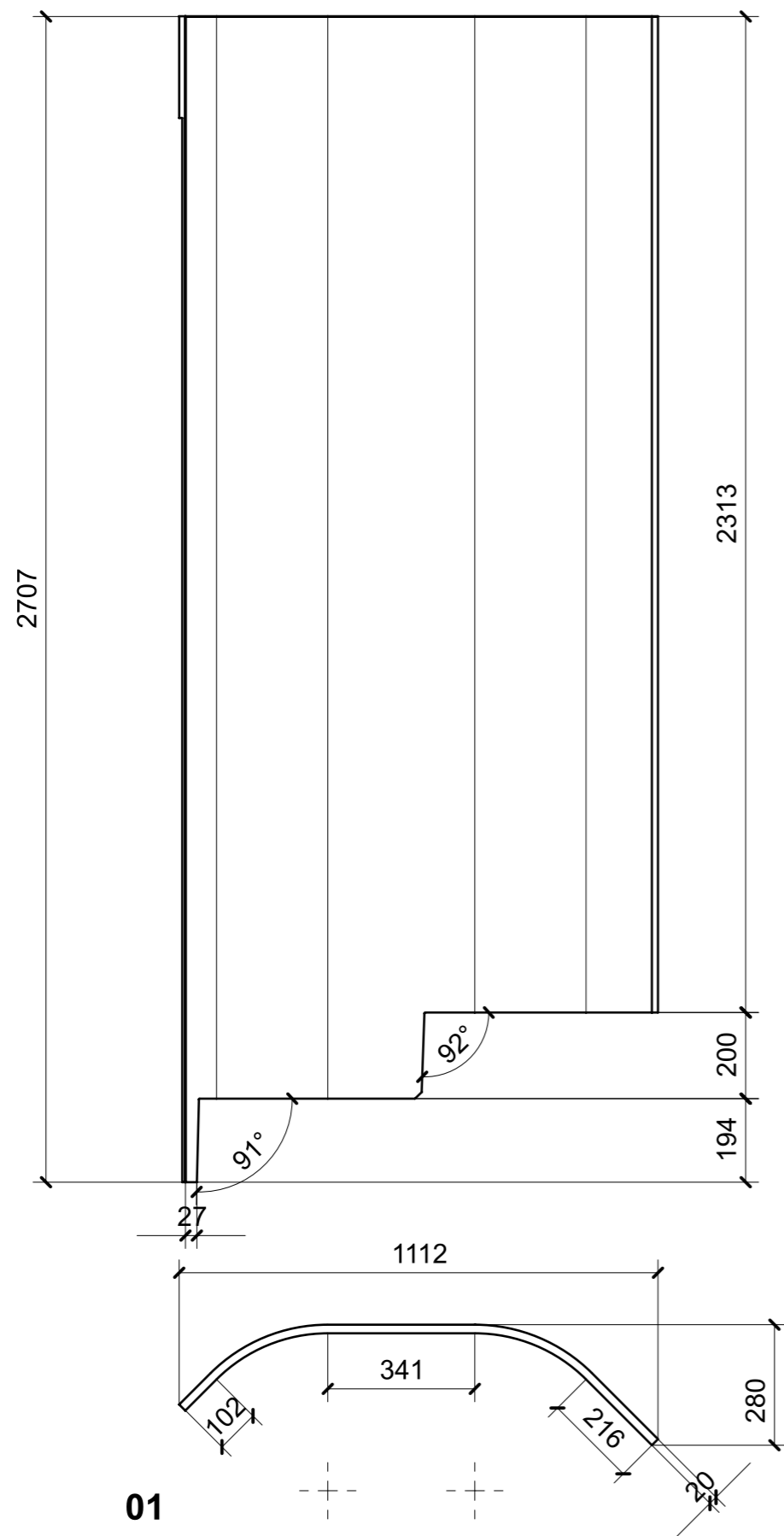

01

VERNICIATURA LASTRA/LACCATI:

● = VERNICIARE 1 LATO + FILI RASATI O BORDATI

NESSUN SIMBOLO = VERNICIARE 2 LATI + FILI RASATI O BORDATI

| LOCALE     | CODICE         | DESCRIZIONE COMPONENTE         | FINITURA                       | GR. |
|------------|----------------|--------------------------------|--------------------------------|-----|
| PARATIE LD | MD321_R01_PR19 | PARATIA DOCCIA BAGNO OSPITI DX | LAISTRA ALPI JAY STRIPED 12.35 | 2   |

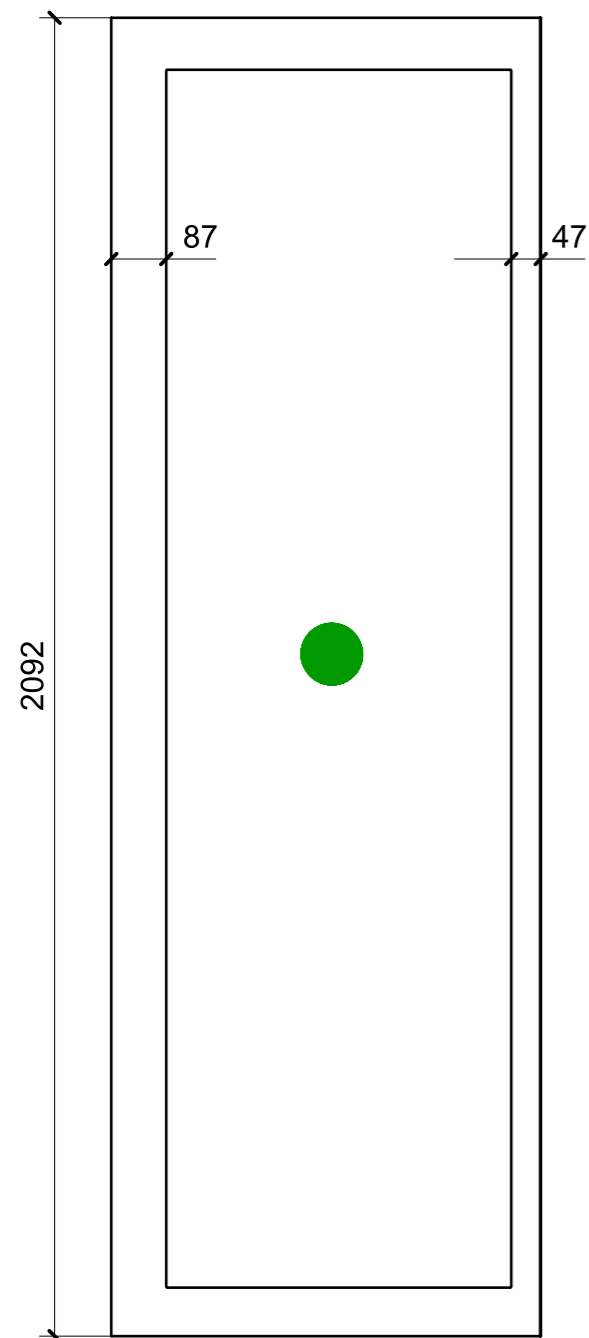

01

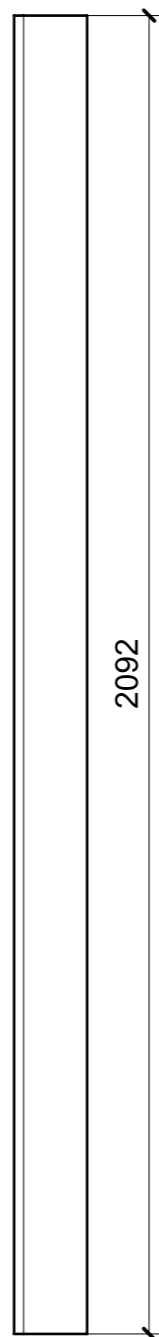
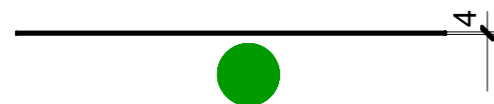

02

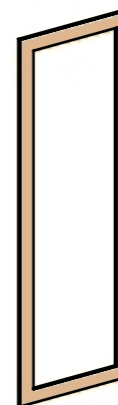
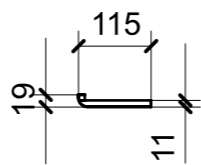

ELEMENTO DA MONTARE  
in MF\_PR19  
e spedire con unico imballo

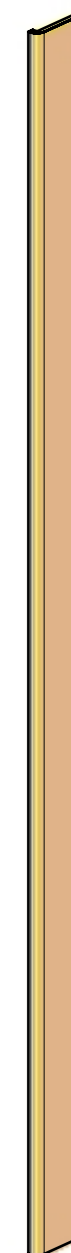
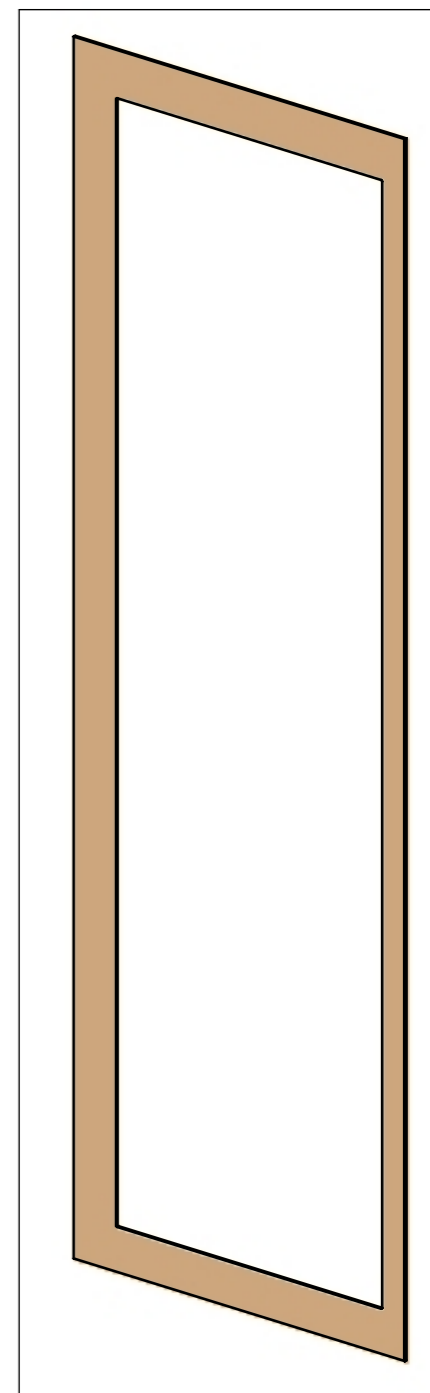

VERNICIATURA LASTRA/LACCATI:

● = VERNICIARE 1 LATO + FILI RASATI O BORDATI

NESSUN SIMBOLO = VERNICIARE 2 LATI + FILI RASATI O BORDATI