

LOCALE	CODICE	DESCRIZIONE COMPONENTE	FINITURA	GR.
LOBBY	MD321_R01_CA01	ARMADIO DX DISCESA ARMATORE	LAISTRA ALPI JAY STRIPED 12.35	2

ELEMENTI DA MONTARE
in MG_CA02
e spedire con unico imballo

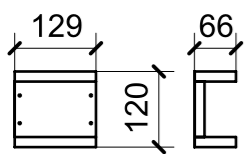

01

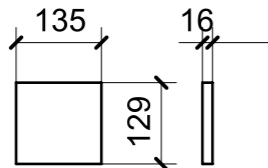

04

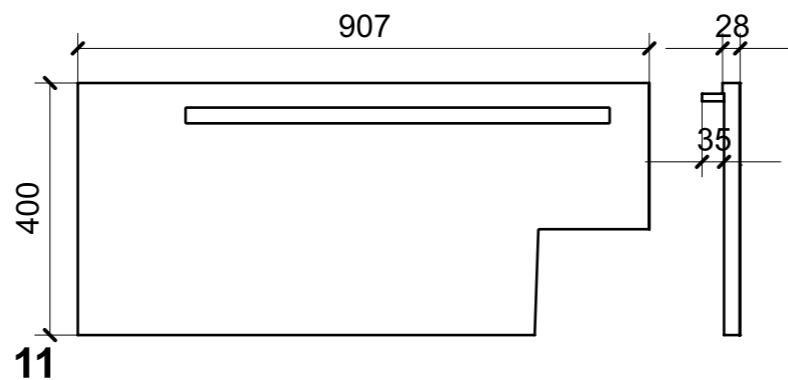

11

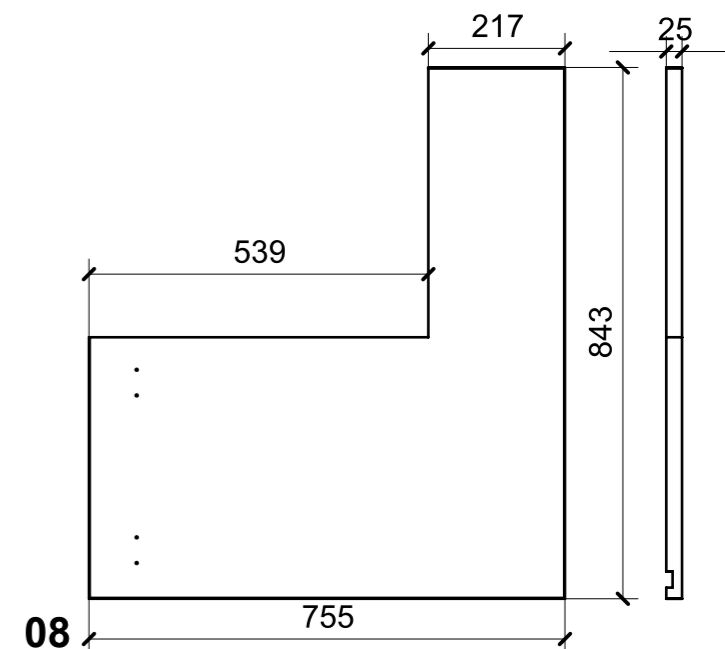

08

ELEMENTI DA MONTARE
in MG_CA03
e spedire con unico imballo

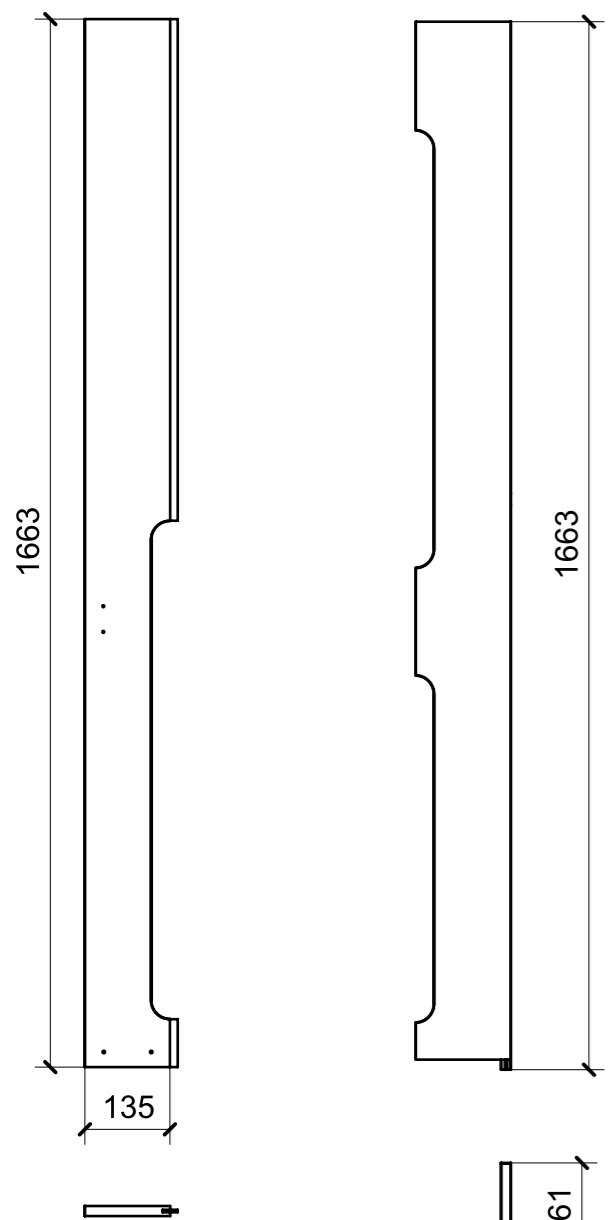

02

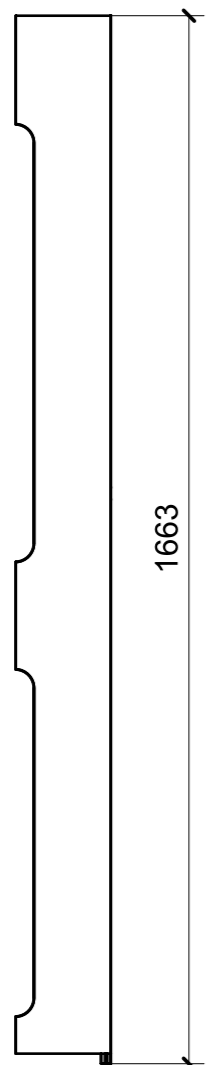

03

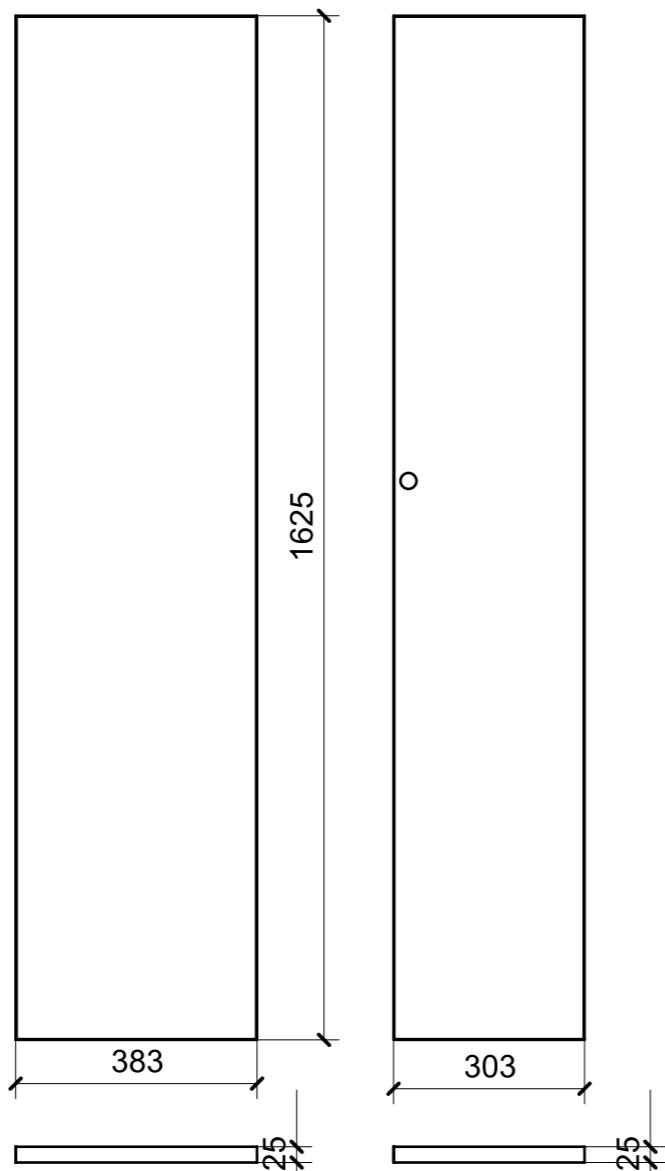

05

06

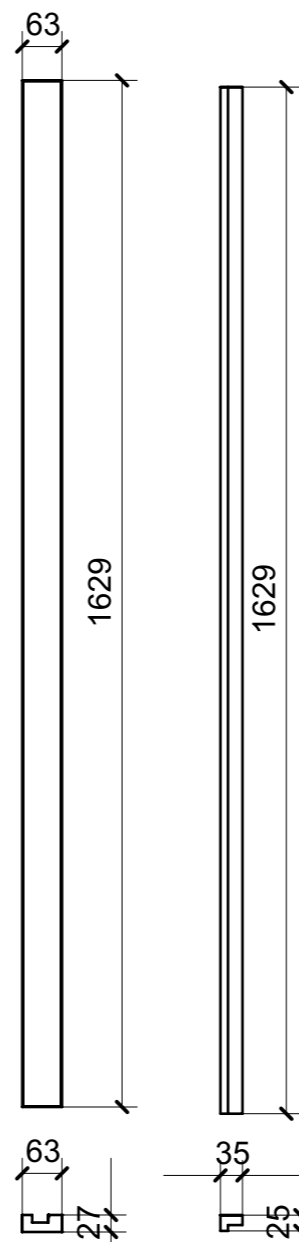

09

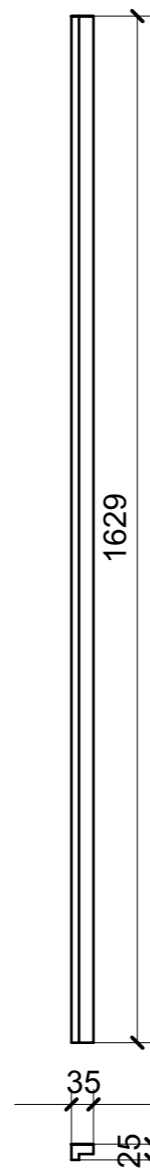

10

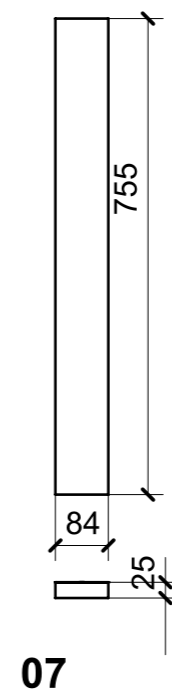

07

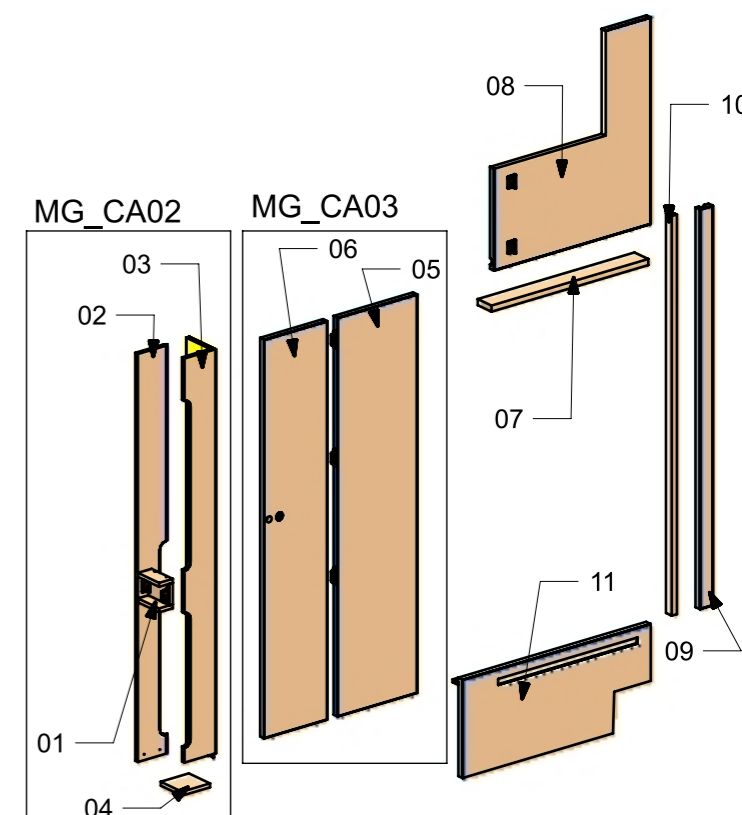

FERRAMENTA	QTY
CERNIERA A SCOMPARSA KUBIKINA-K6100 NO HD_KOBLENZ	3
VITE 4MAX8 ANKOR BORGHI X CERNIERA COLLO PIENO	8
BUSSOLA 5MA ANKOR BORGHI X CERNIERA COLLO PIENO	8
PUSH TO CLOSE_SOUTHCO-MP-05-312-55 NERA_TECHNOPARTNER	1
KEEPER PUSH TO CLOSE_SOUTCHO-J-M1-519-4_TECHNOPARTNER	1
BUSSOLA 6MA X 10 FORO DIAM.8	9
CHIUSURA A SPINTA_TECHNOPARTNER_SOU C3-203	4

VERNICIATURA LASTRA/LACCATI: ● = VERNICIARE 1 LATO + FILI RASATI O BORDATI NESSUN SIMBOLO = VERNICIARE 2 LATI + FILI RASATI O BORDATI

LOCALE	CODICE	DESCRIZIONE COMPONENTE	FINITURA	GR.
LOBBY	MD321_R01_CB01	ARMADIO SX DISCESA ARMATORE	LASTRA ALPI JAY STRIPED 12.35	2

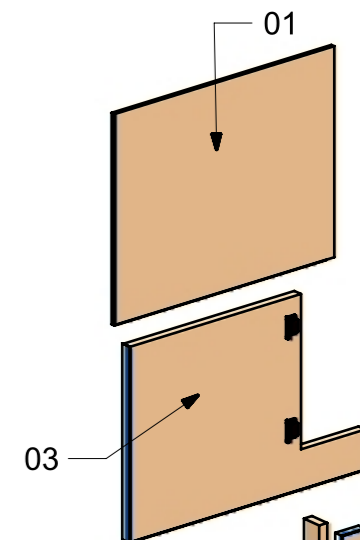
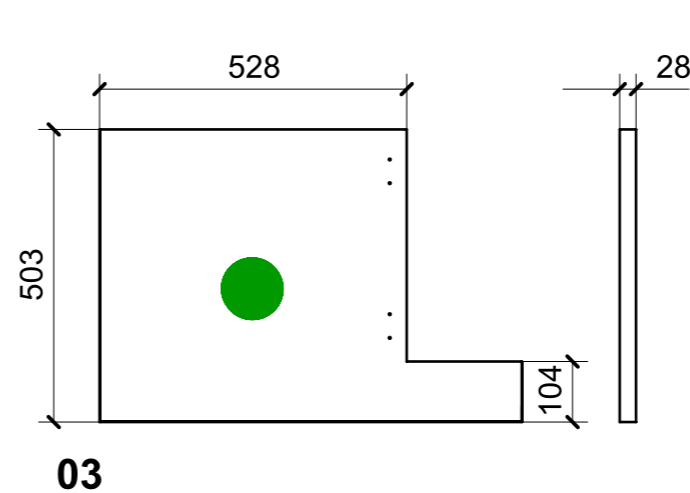
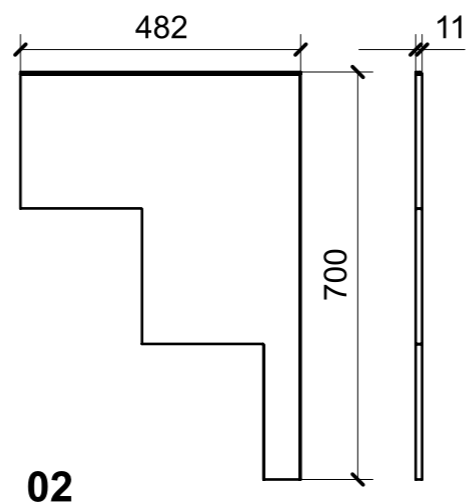
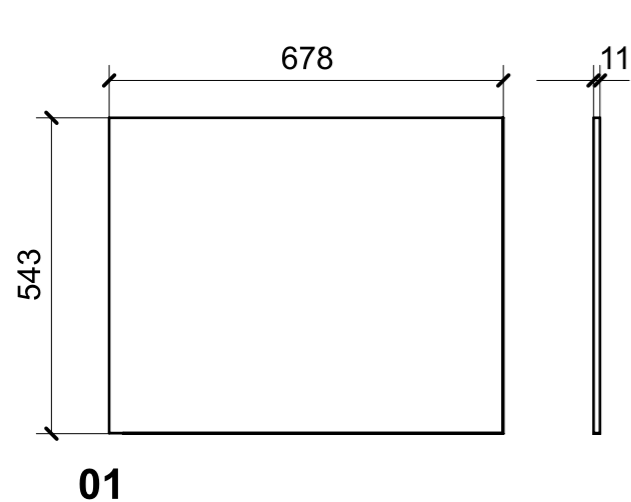

ELEMENTI DA MONTARE
in MG_CB02
e spedire con unico imballo

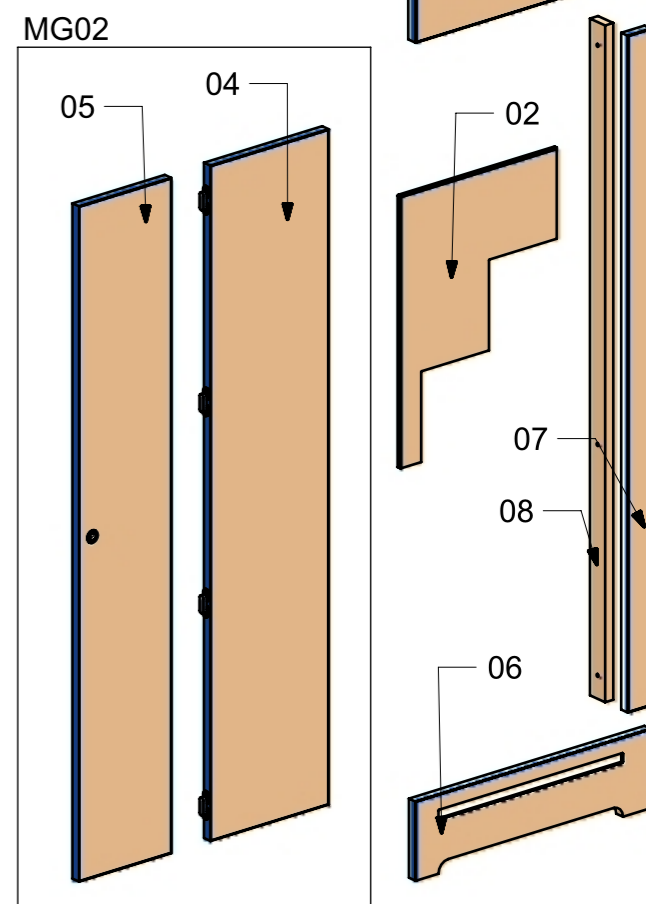
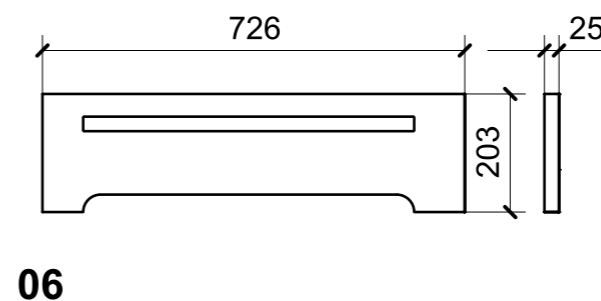
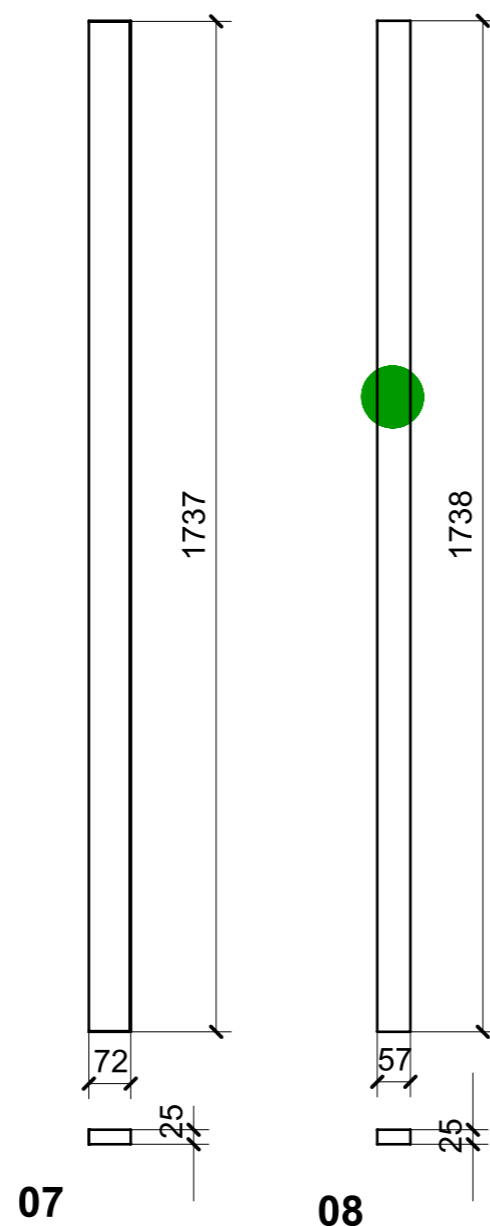
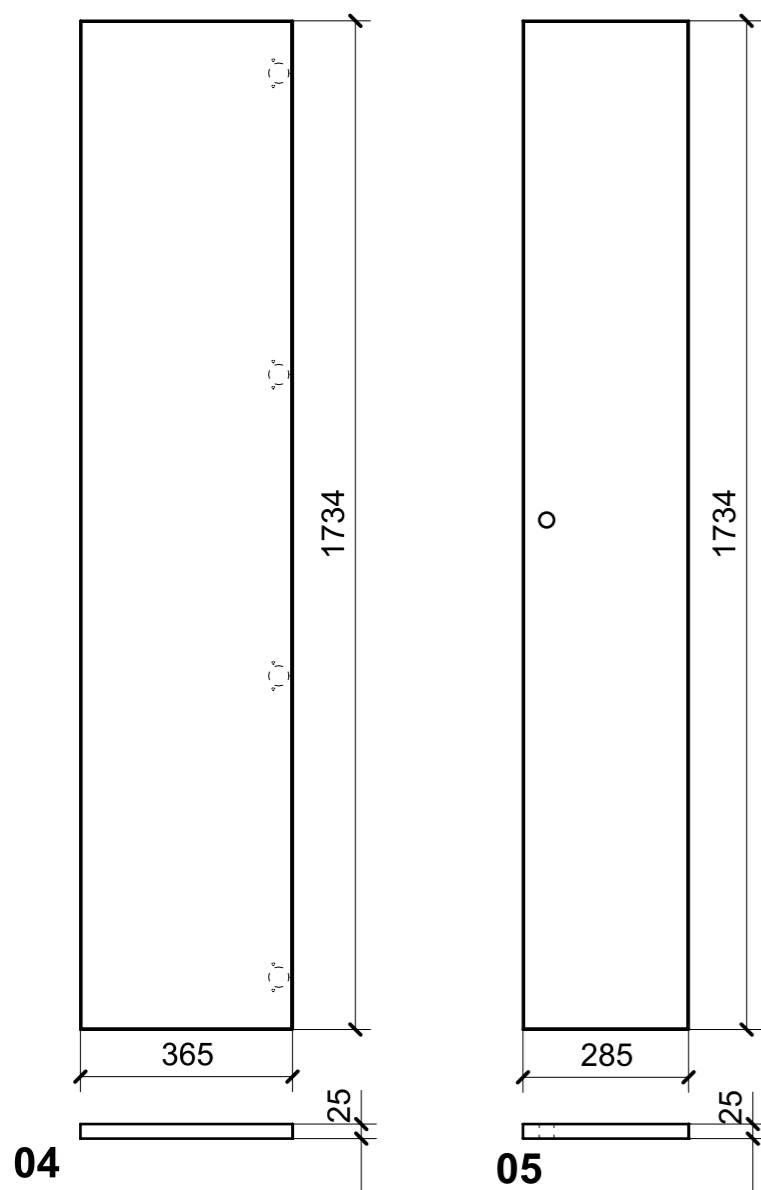

FERRAMENTA	QTY
CERNIERA A SCOMPARSA KUBIKINA-K6100 NO HD_KOBLENZ	4
CHIUSURA A SPINTA_TECHNOPARTNER_SOU C3-203	2
FITLOCK M_MASCHERPA_3MM_6020202101	4
PUSH TO CLOSE_SOUTHCO-MP-05-312-55 NERA_TECHNOPARTNER	1

VERNICIATURA LASTRA/LACCATI:

● = VERNICIARE 1 LATO + FILI RASATI O BORDATI

NESSUN SIMBOLO = VERNICIARE 2 LATI + FILI RASATI O BORDATI

LOCALE	CODICE	DESCRIZIONE COMPONENTE	FINITURA	GR.
LOBBY	MD321_R01_CC01	GRADINI SCALA	LASTRA ALPI JAY STRIPED 12.35	2

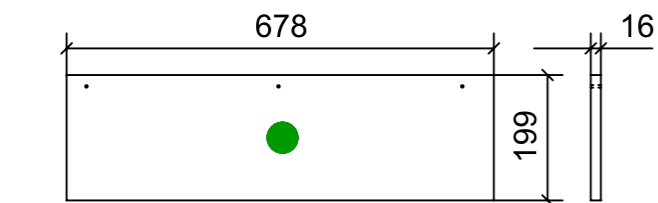

01

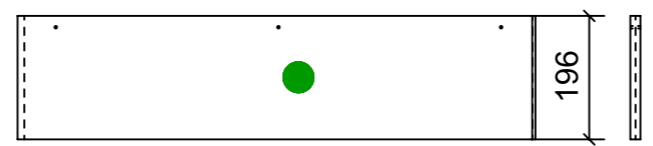

05

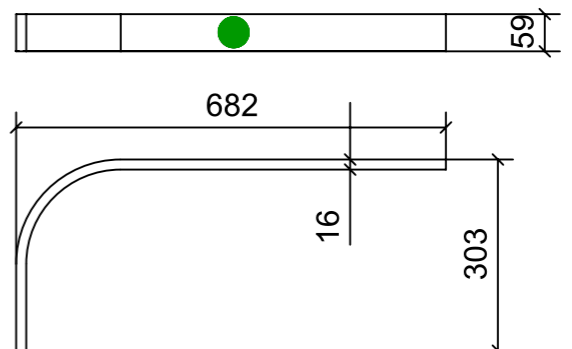

11

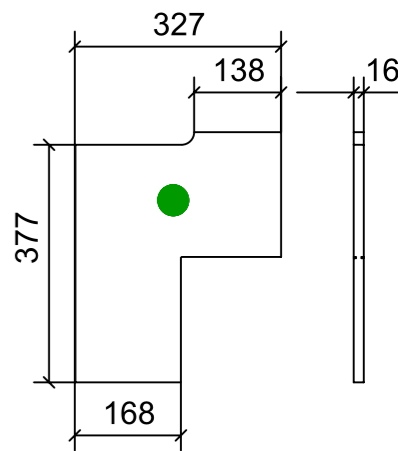

13

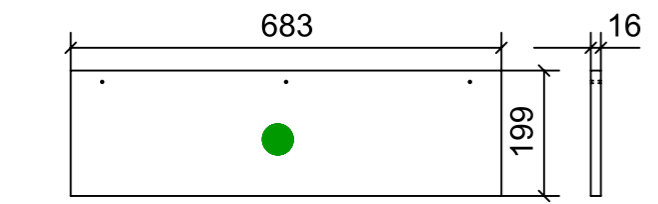

02

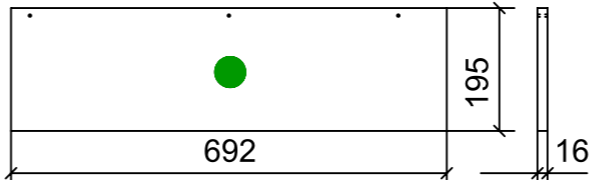

07

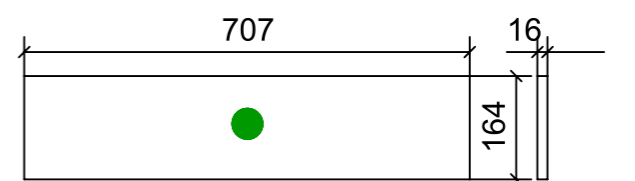

10

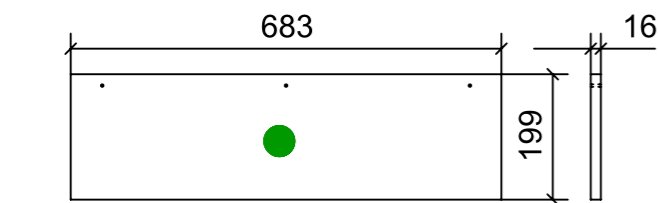

03

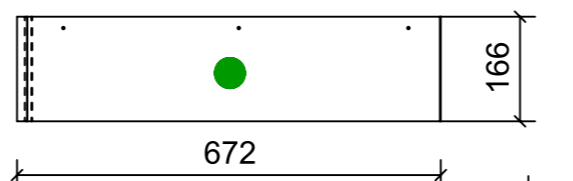

08

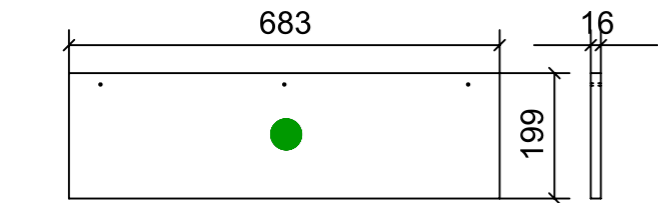
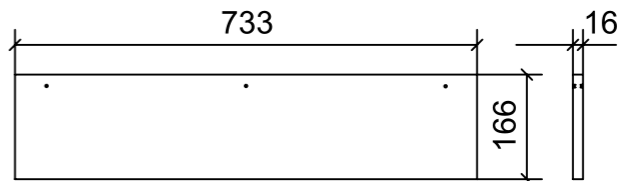

04

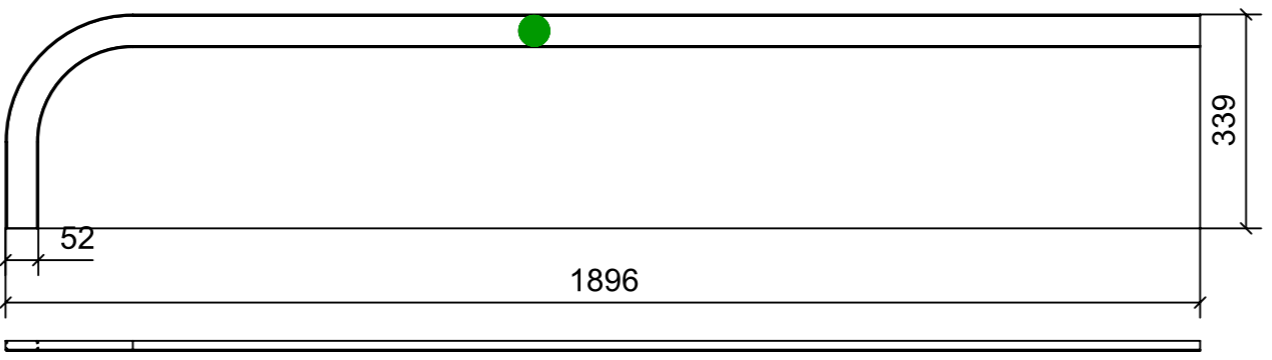

12

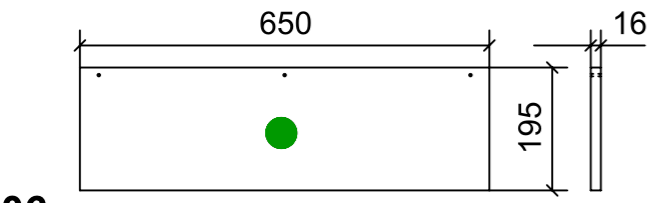
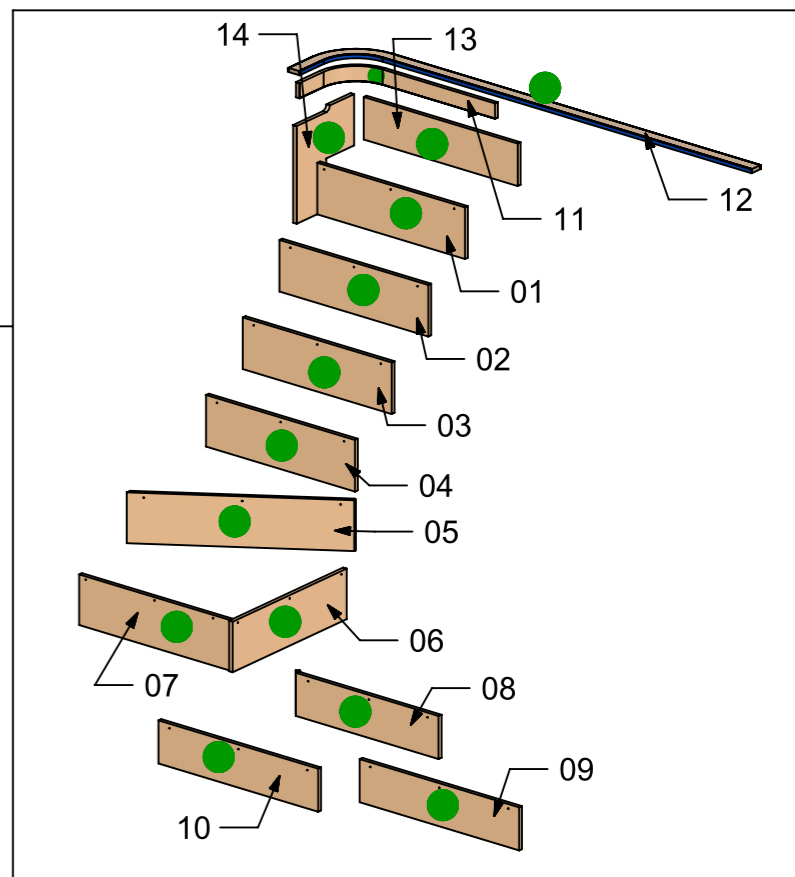

06

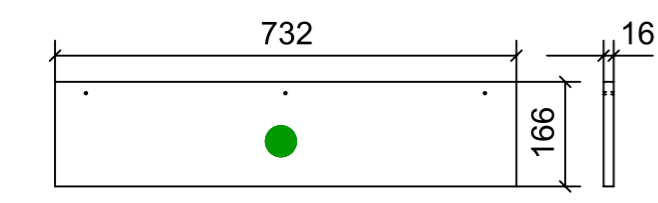

09

VERNICIATURA LASTRA/LACCATI: ● = VERNICIARE 1 LATO + FILI RASATI O BORDATI NESSUN SIMBOLO = VERNICIARE 2 LATI + FILI RASATI O BORDATI

LOCALE	CODICE	DESCRIZIONE COMPONENTE	FINITURA	GR.
LOBBY	MD321_R01_CD01	MURETTO DISCESA SCALE	LASTRA ALPI JAY STRIPED 12.35	2

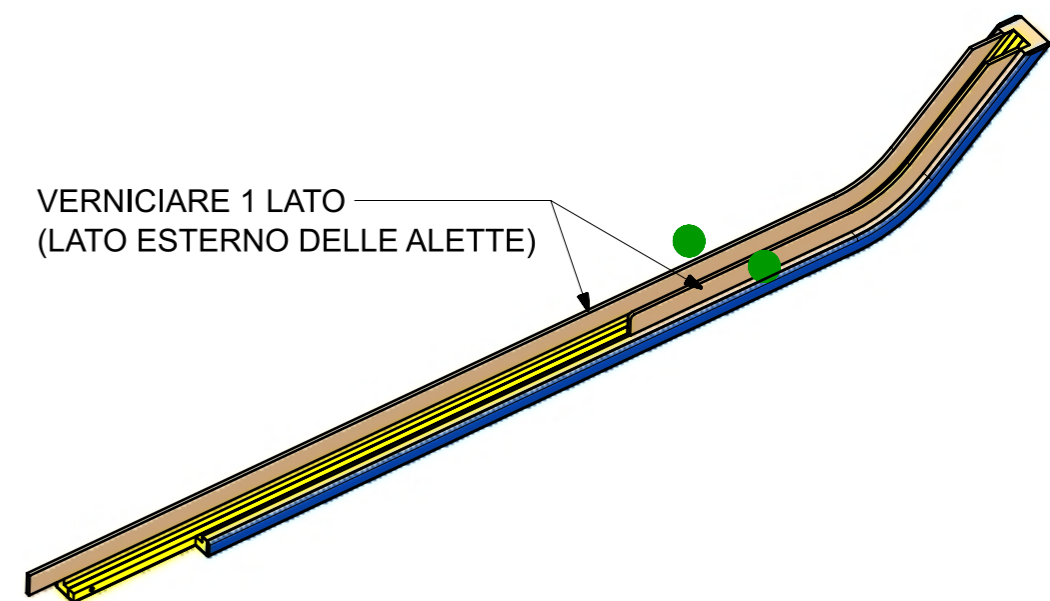
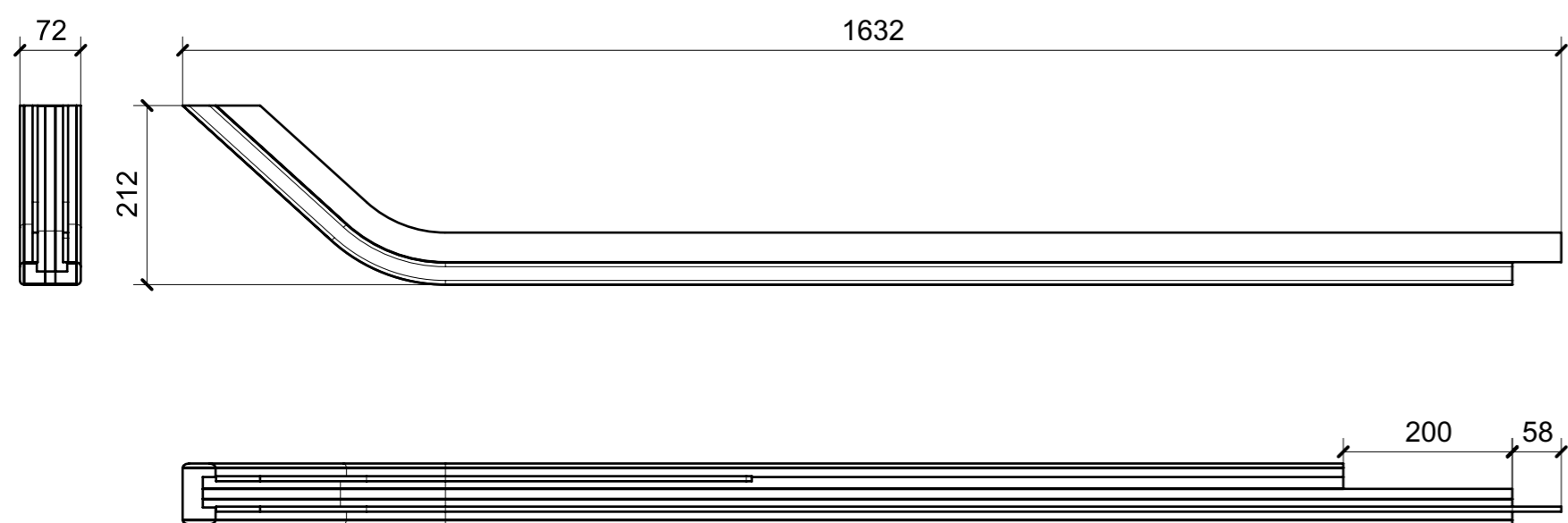
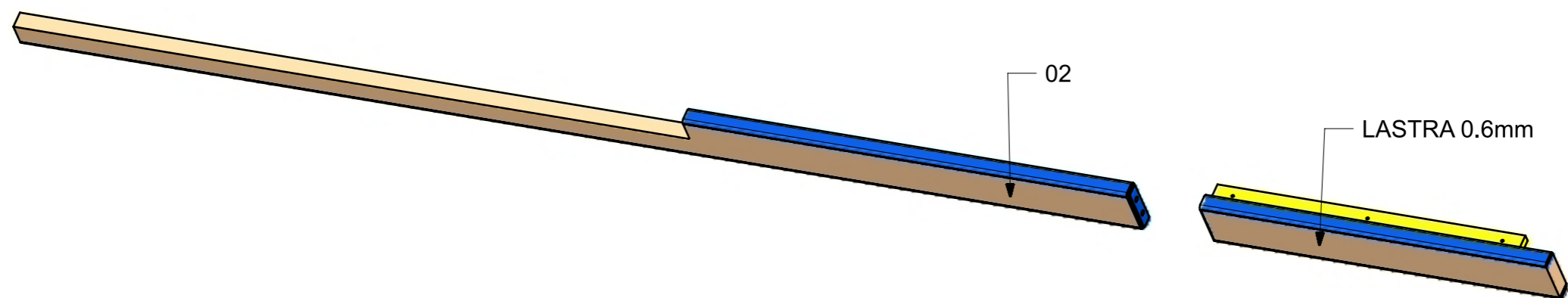
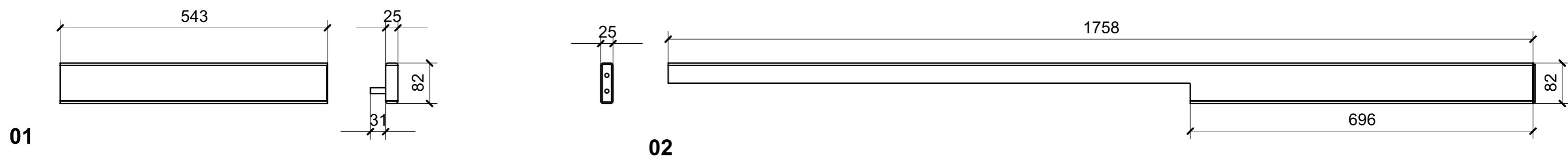

VERNICIATURA LASTRA/LACCATI:

● = VERNICIARE 1 LATO + FILI RASATI O BORDATI

NESSUN SIMBOLO = VERNICIARE 2 LATI + FILI RASATI O BORDATI

LOCALE	CODICE	DESCRIZIONE COMPONENTE	FINITURA	GR.
LOBBY	MD321_R02_CD01	MURETTO DISCESA SCALE	LASTRA ALPI JAY FLAMED 12.34	2

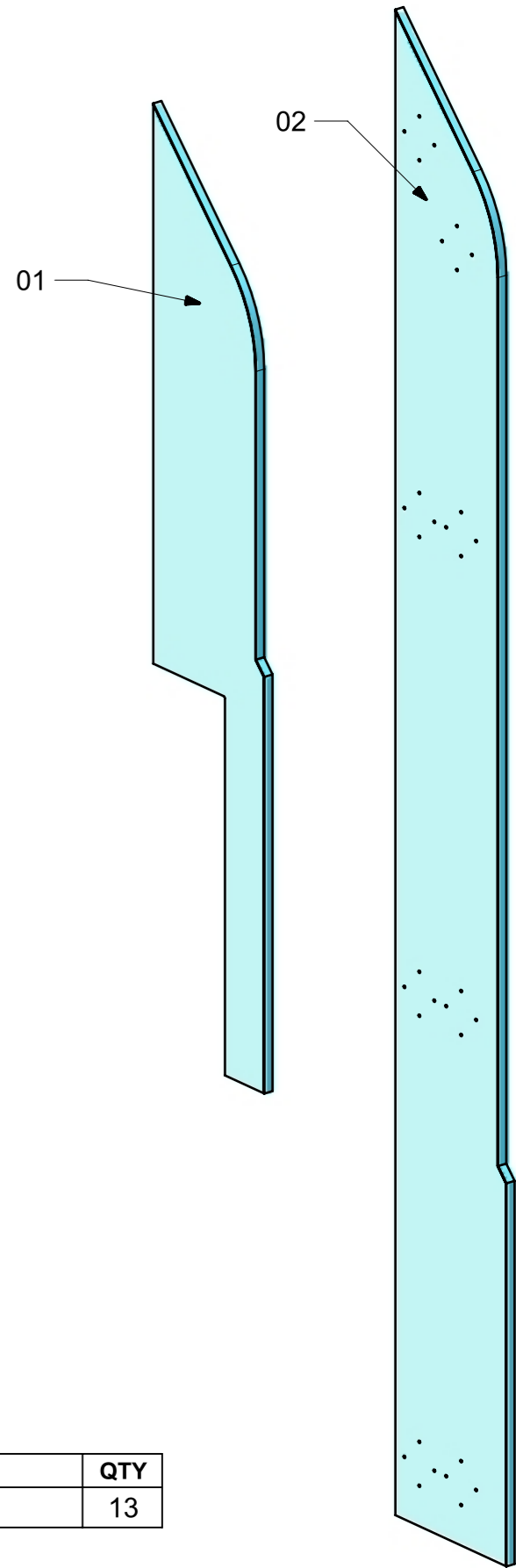
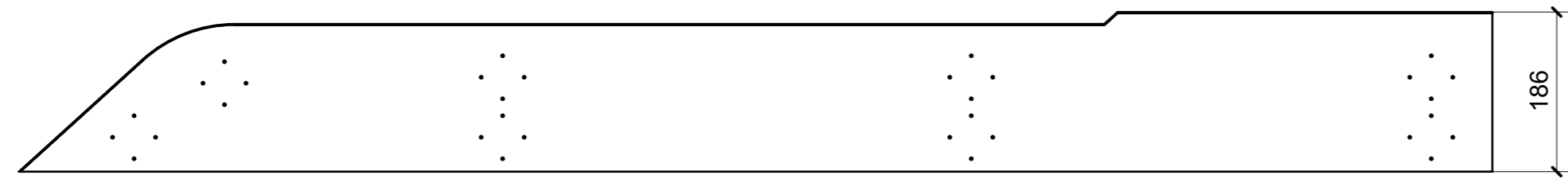
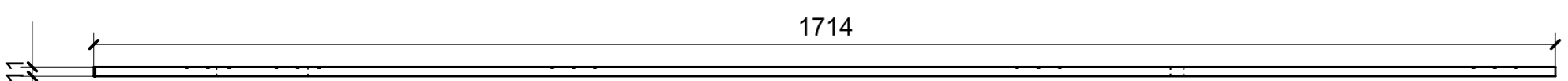
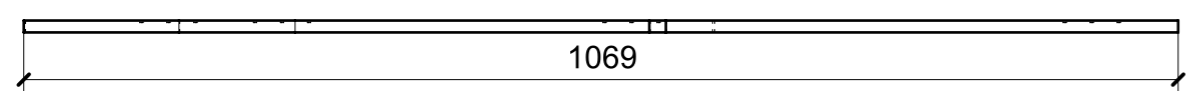
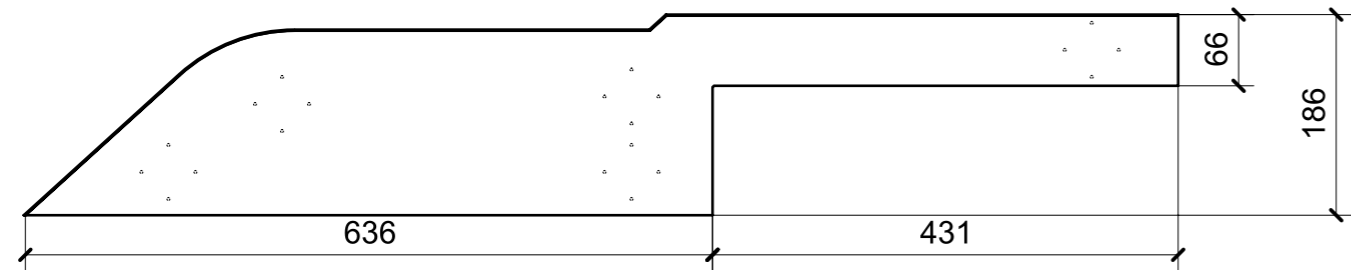

FERRAMENTA	QTY
FITLOCK M_MASCHERPA_3MM_6020202101	13

VERNICIATURA LASTRA/LACCATI:
● = VERNICIARE 1 LATO + FILI RASATI O BORDATI NESSUN SIMBOLO = VERNICIARE 2 LATI + FILI RASATI O BORDATI

LOCALE	CODICE	DESCRIZIONE COMPONENTE	FINITURA	GR.
LOBBY	MD321_R01_CE01	CIELINO DISCESA ARMATORE	LASTRA ALPI JAY STRIPED 12.35	PTP

SECTION G-G

01

ELEMENTI DA MONTARE
in MG_CE01
e spedire con unico imballo

03

04

ELEMENTI DA MONTARE
in MG_CE02
e spedire con unico imballo

VERNICIATURA LASTRA/LACCATI:

● = VERNICIARE 1 LATO + FILI RASATI O BORDATI

NESSUN SIMBOLO = VERNICIARE 2 LATI + FILI RASATI O BORDATI

LOCALE	CODICE	DESCRIZIONE COMPONENTE	FINITURA	GR.
LOBBY	MD321_R01_CF01	RIVESTIMENTI LOBBY	LASTRA ALPI JAY STRIPED 12.35	PTP

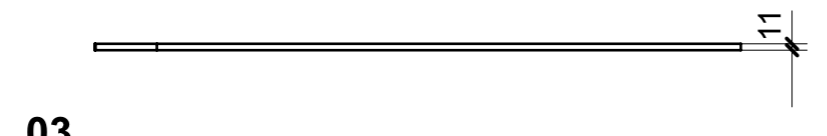
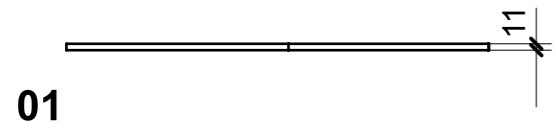
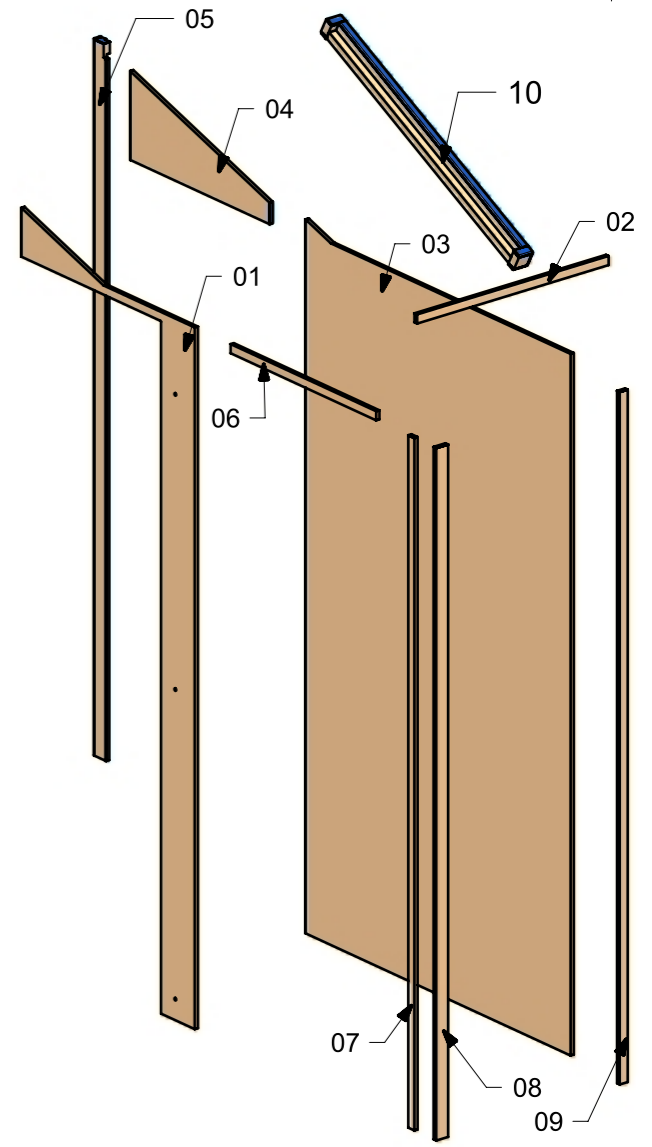
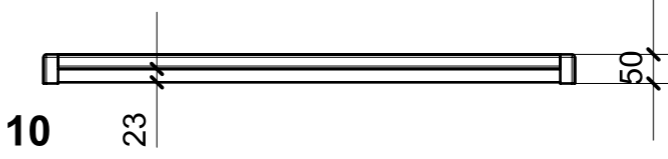
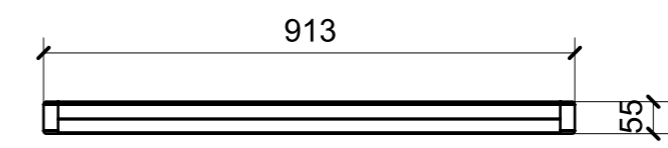
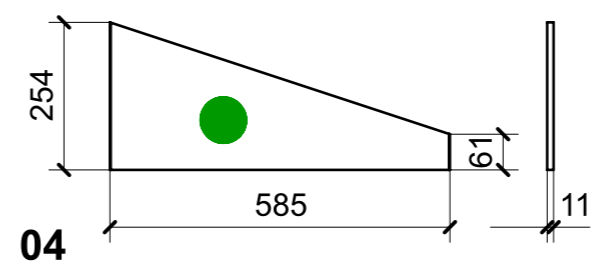
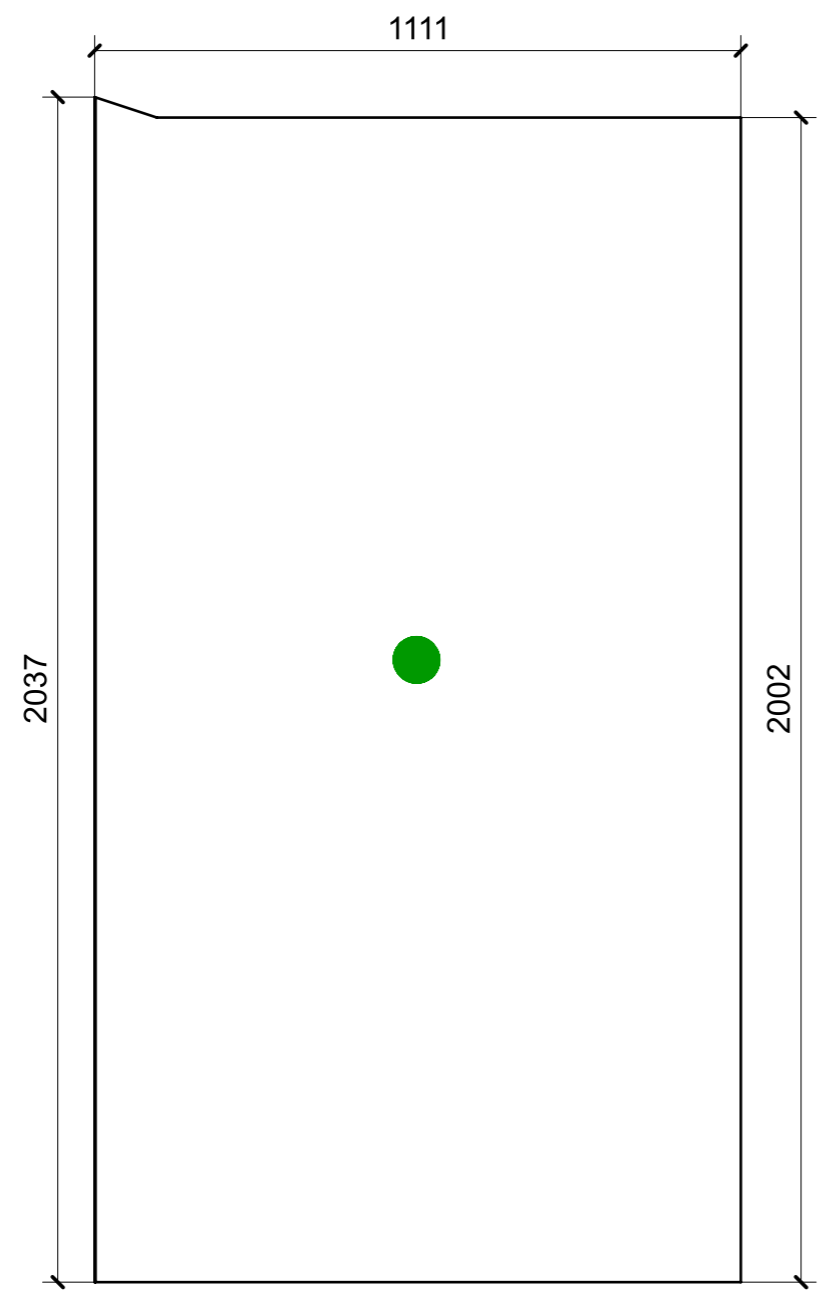
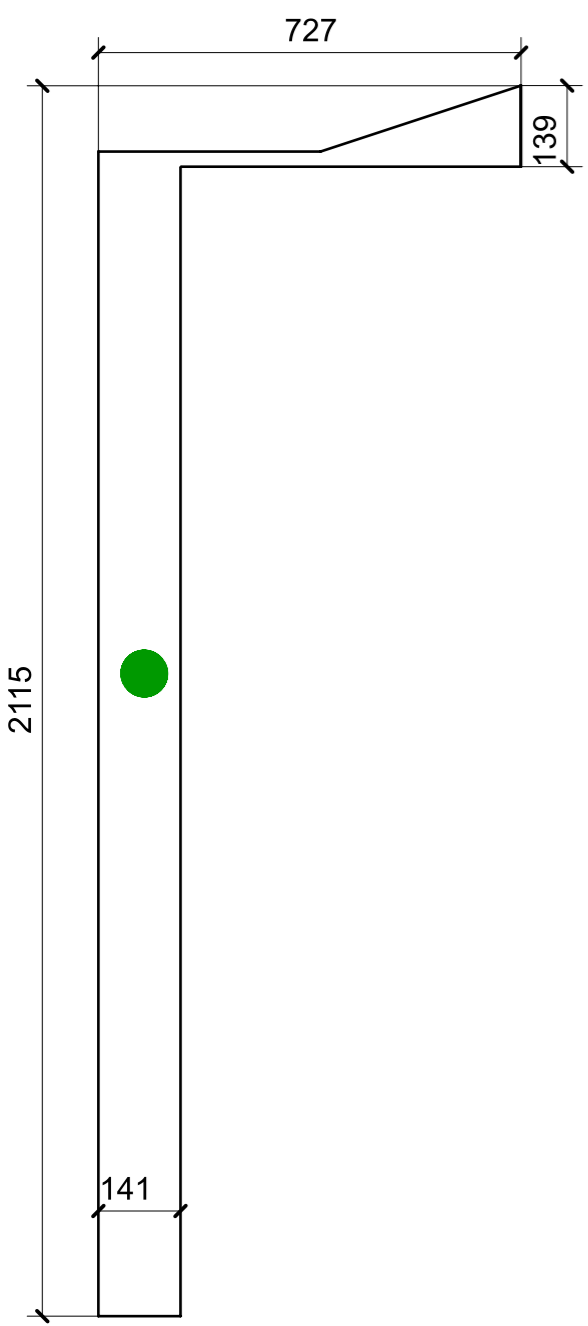
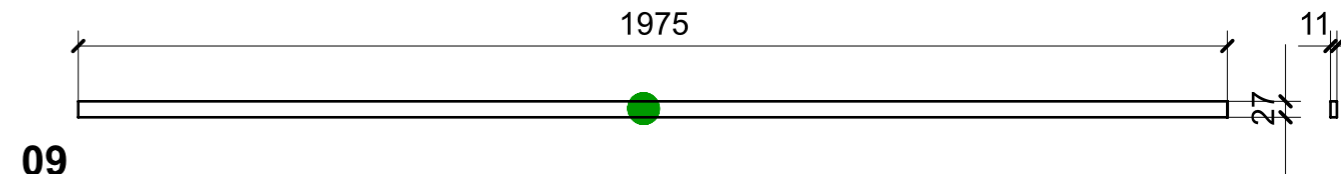
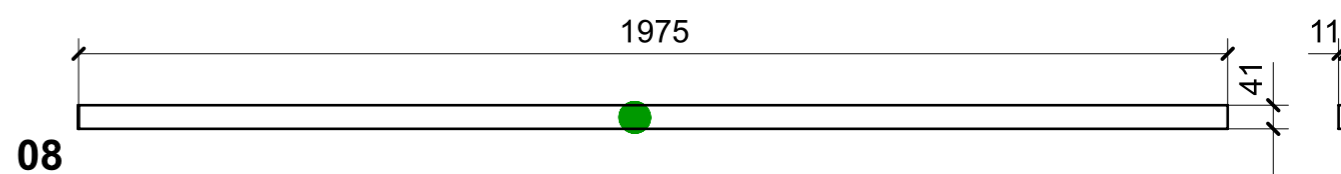
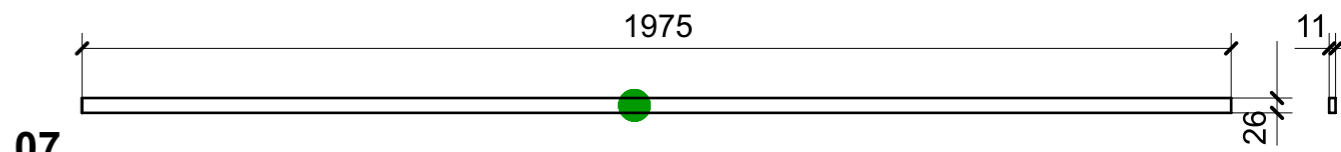
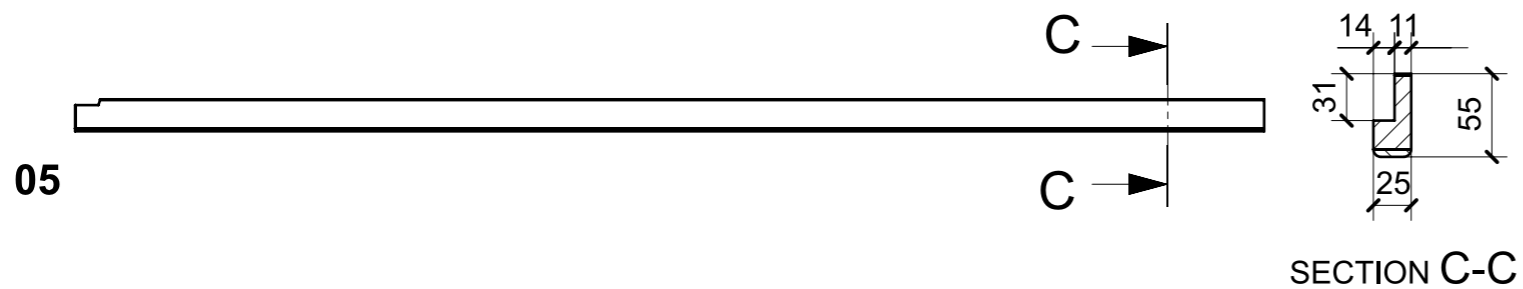

● VERNICIATURA LASTRA/LACCATI:
 = VERNICIARE 1 LATO + FILI RASATI O BORDATI
 NESSUN SIMBOLO = VERNICIARE 2 LATI + FILI RASATI O BORDATI