

LOCALE	CODICE	DESCRIZIONE COMPONENTE	FINITURA	GR.
CABINA VIP	MD321_R01_VA01	ARMADIO SX	LAISTRA ALPI JAY STRIPED 12.35	2

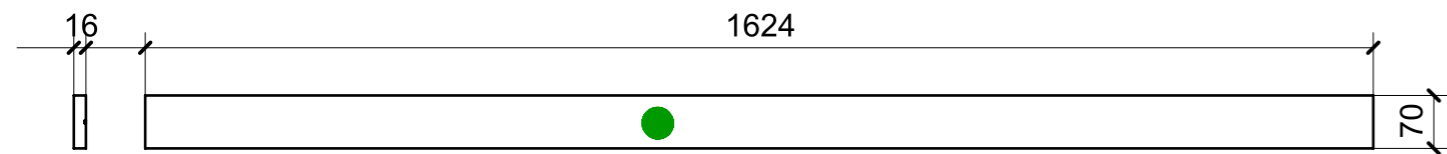

01

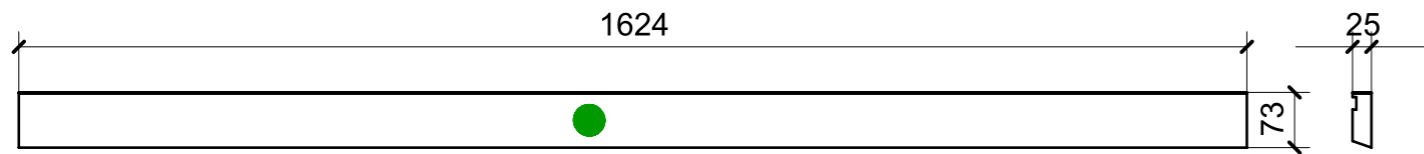

02

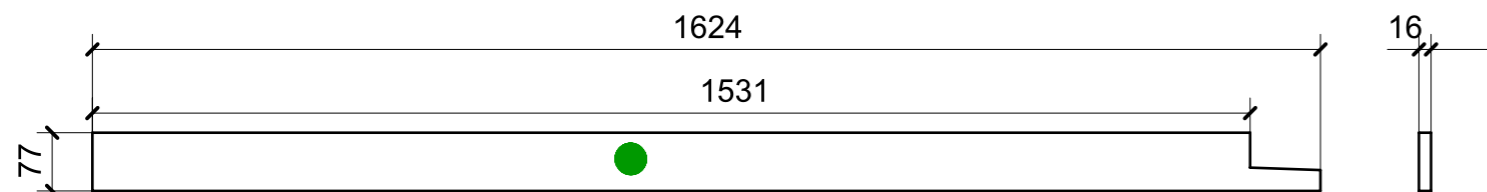

04

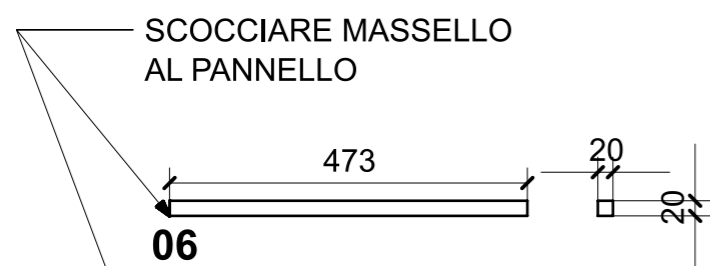

06

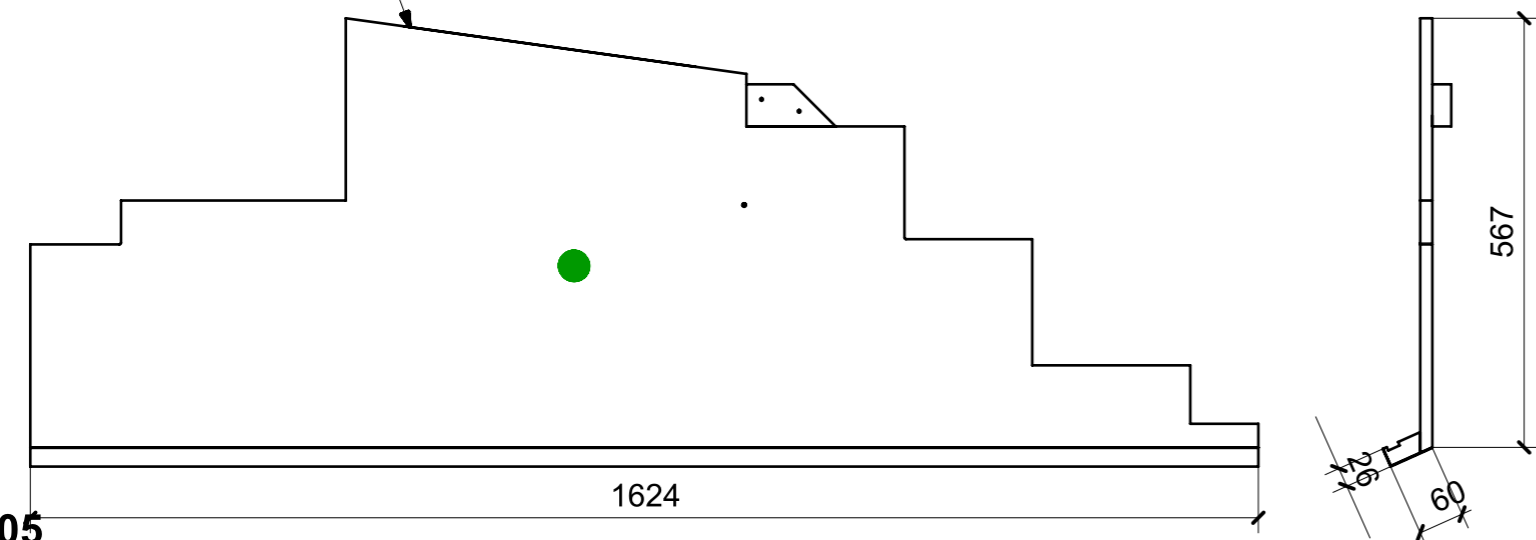

05

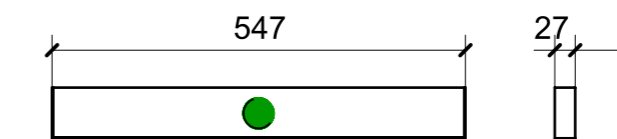

03

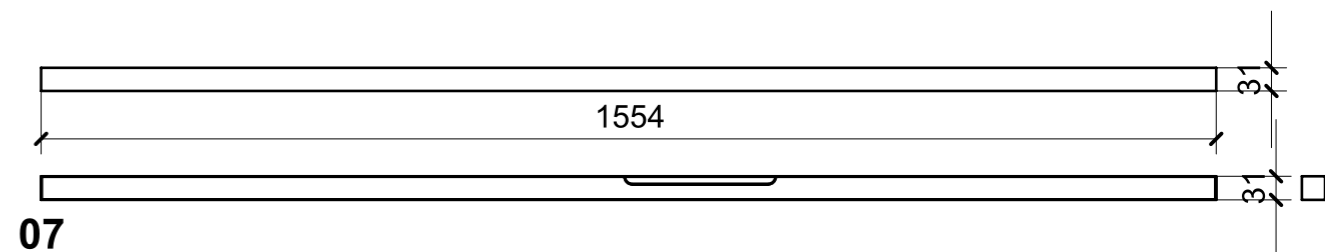

07

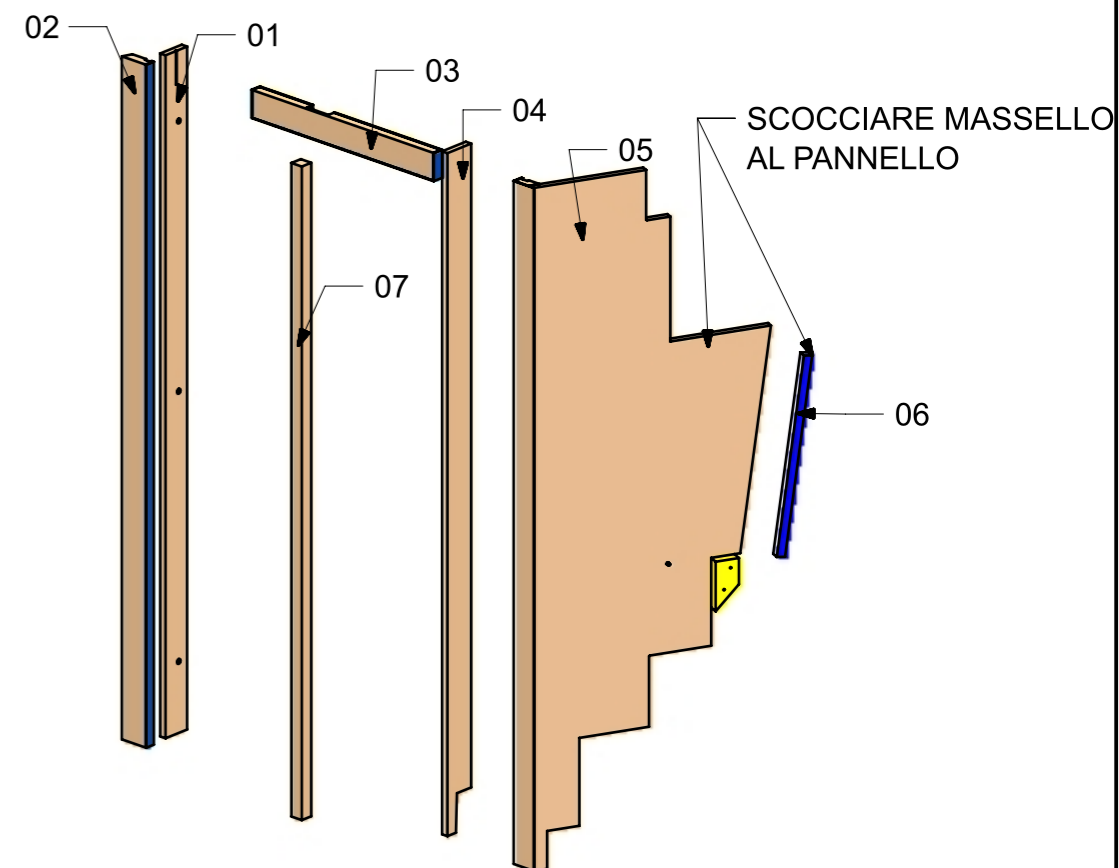

FERRAMENTA	QTY
SENSORE RETROANTA_HAFELE_833_89_334	1
PERNO LISCIO PER SPALLA_FBC BORGHI_1033PXX050531	1
BUSSOLA 6MA X 10 FORO DIAM.8	11

VERNICIATURA LASTRA/LACCATI:

● = VERNICIARE 1 LATO + FILI RASATI O BORDATI

NESSUN SIMBOLO = VERNICIARE 2 LATI + FILI RASATI O BORDATI

LOCALE	CODICE	DESCRIZIONE COMPONENTE	FINITURA	GR.
CABINA VIP	MD321_R02_VA01	ARMADIO SX	LASTRA ALPI JAY FLAMED 12.34	2

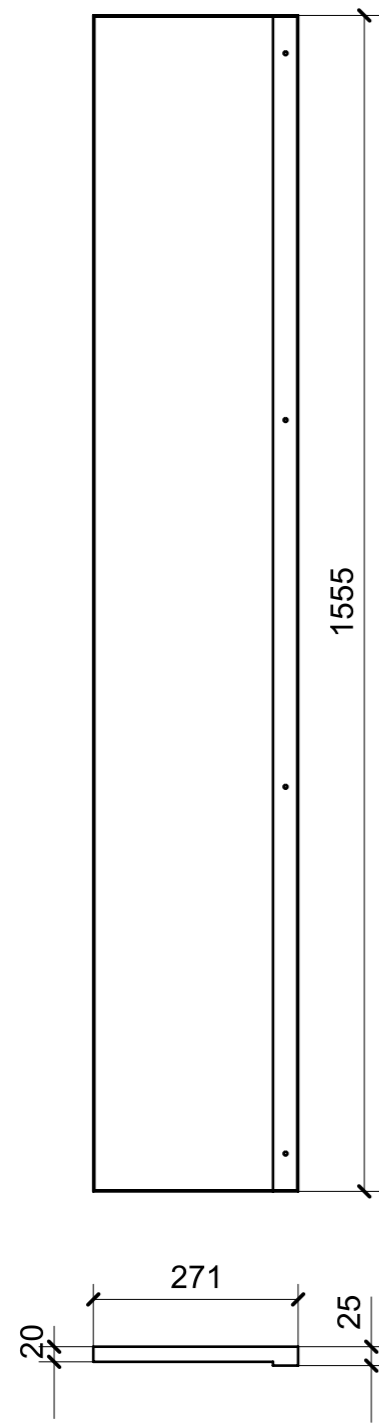

01

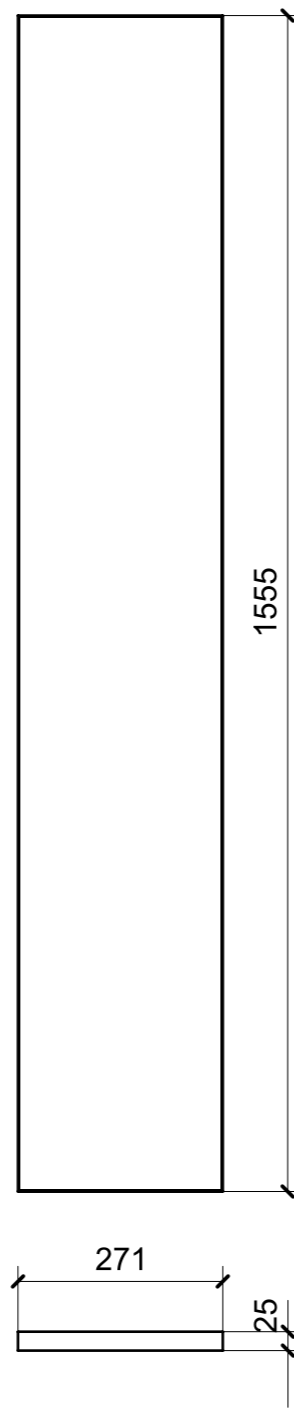

02

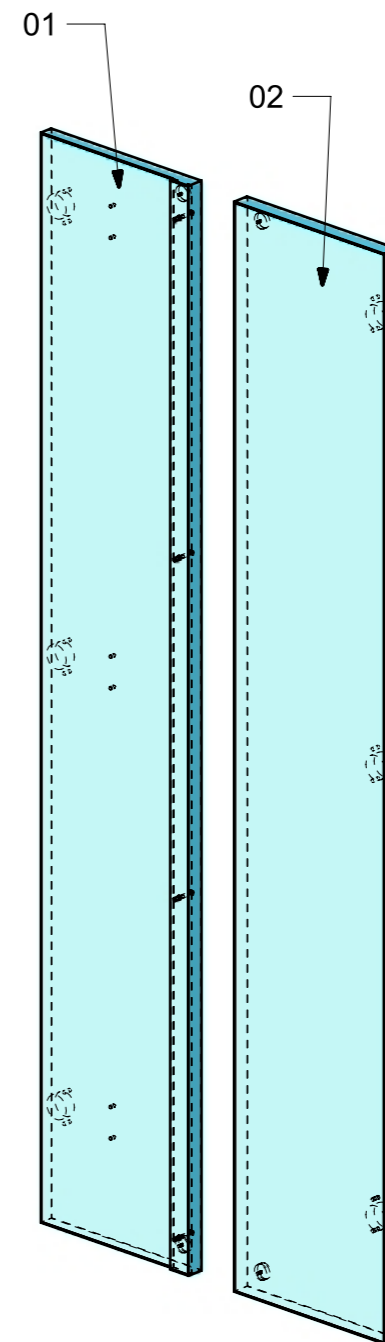

FERRAMENTA	QTY
VITE 4MA X 35 TESTA SVASATA ESAGONALE NERA_FBC_21104	4
BUSSOLA 5MA ANKOR BORGHI X CERNIERA COLLO PIENO	12
MAGNETE FORZA MAGNETICA1-5 10KG_HAFELE_246.87.112	4

VERNICIATURA LASTRA/LACCATI:

● = VERNICIARE 1 LATO + FILI RASATI O BORDATI

NESSUN SIMBOLO = VERNICIARE 2 LATI + FILI RASATI O BORDATI

LOCALE	CODICE	DESCRIZIONE COMPONENTE	FINITURA	GR.
CABINA VIP	MD321_R01_VB01	MURATA SX	LASTRA ALPI JAY STRIPED 12.35	2

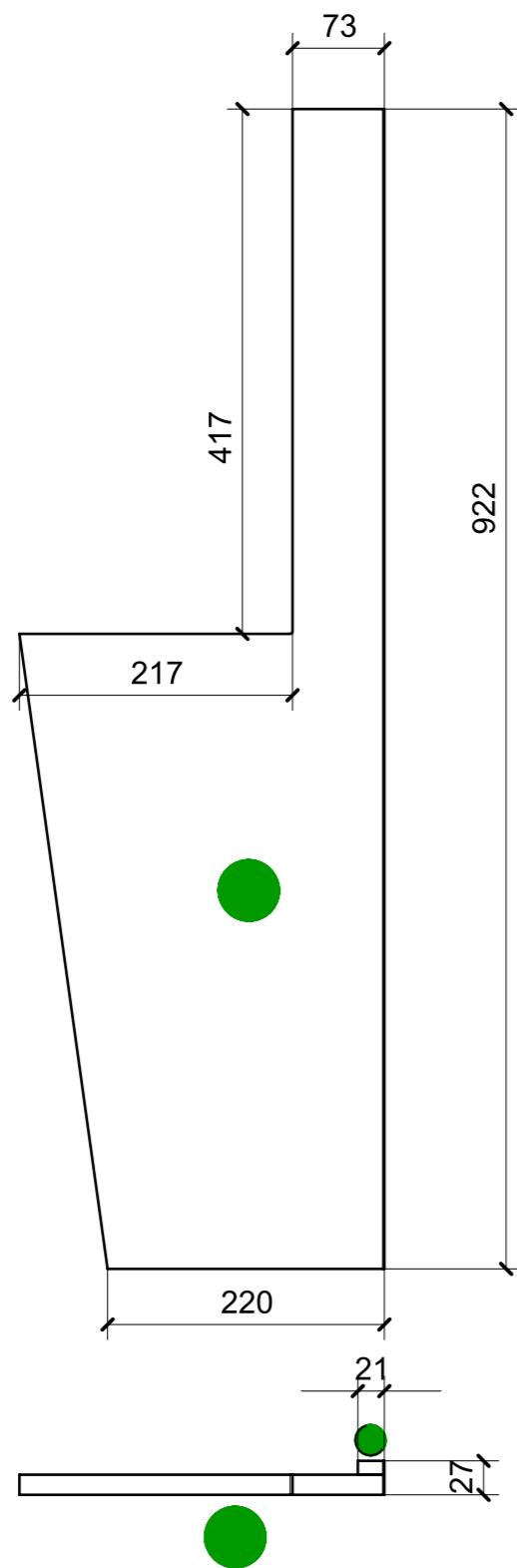

01

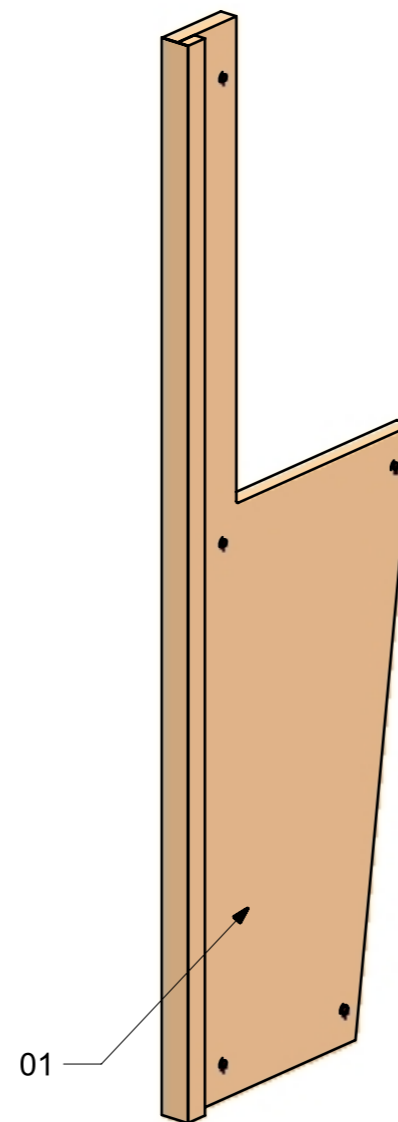

FERRAMENTA	QTY
BUSSOLA 6MA X 10 FORO DIAM.8	5

VERNICIATURA LASTRA/LACCATI:

● = VERNICIARE 1 LATO + FILI RASATI O BORDATI

NESSUN SIMBOLO = VERNICIARE 2 LATI + FILI RASATI O BORDATI

LOCALE	CODICE	DESCRIZIONE COMPONENTE	FINITURA	GR.
CABINA VIP	MD321_R01_VD01	PLENUM SX	LASTRA ALPI JAY STRIPED 12.35	2

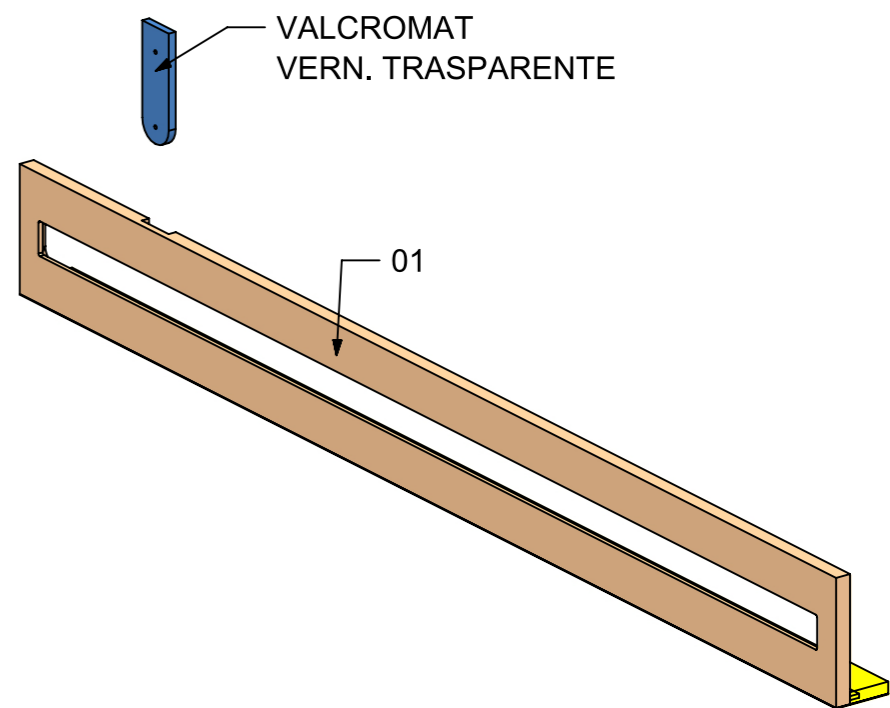
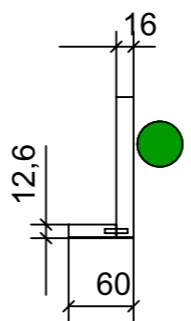
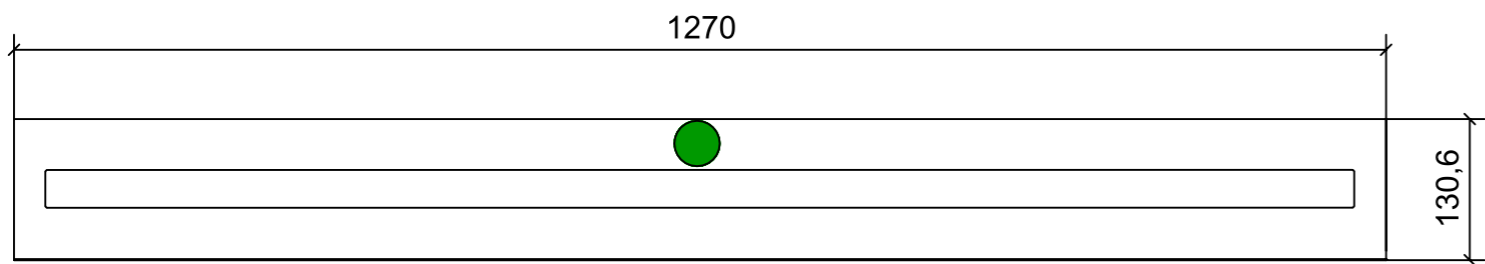

01

ELEMENTO DA MONTARE  
in MF\_VD01  
e spedire con unico imballo

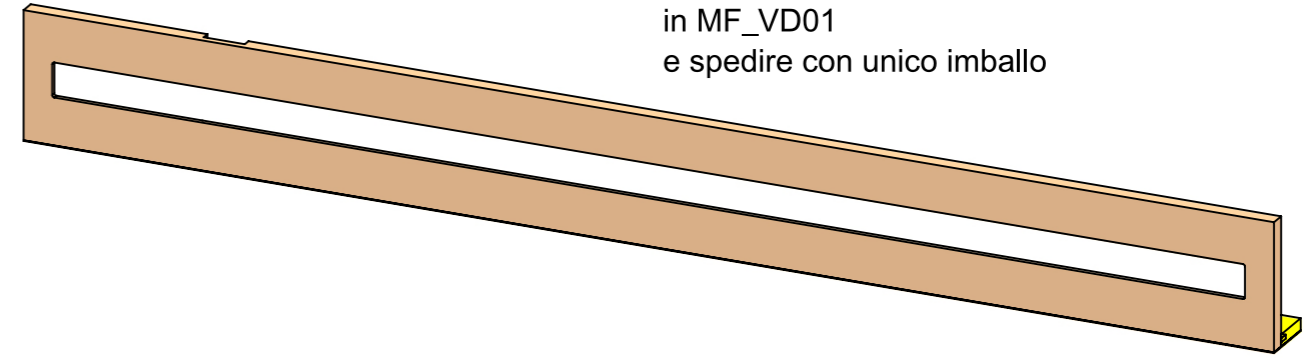

VERNICIATURA LASTRA/LACCATI:  
● = VERNICIARE 1 LATO + FILI RASATI O BORDATI      NESSUN SIMBOLO = VERNICIARE 2 LATI + FILI RASATI O BORDATI

LOCALE	CODICE	DESCRIZIONE COMPONENTE	FINITURA	GR.
CABINA VIP	MD321_R02_VE01	COMODINO	LASTRA ALPI JAY FLAMED 12.34	PTP

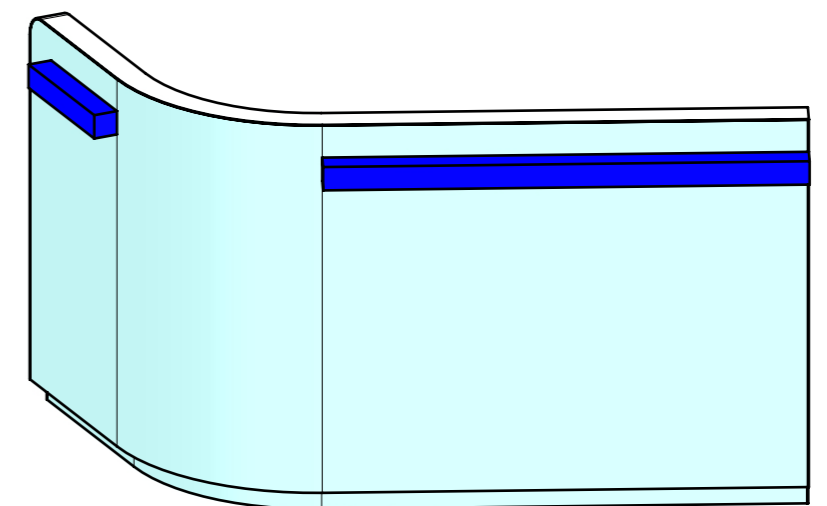
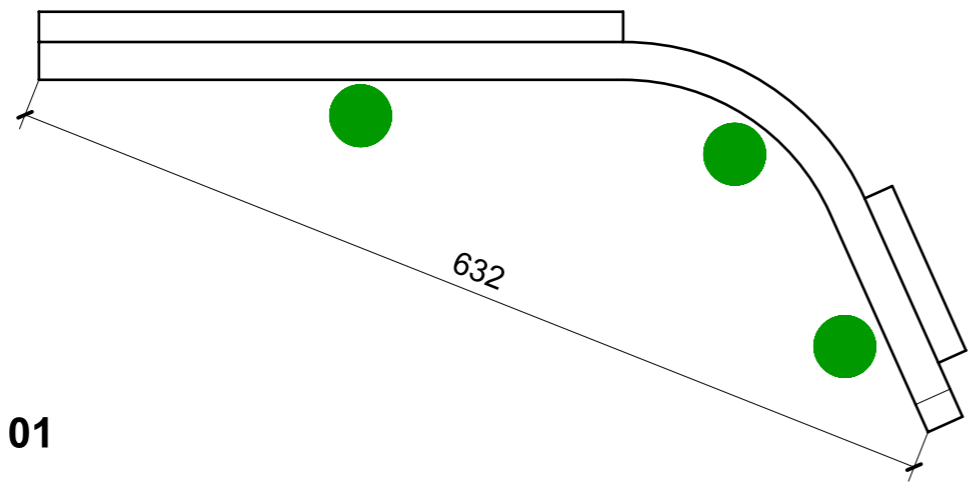
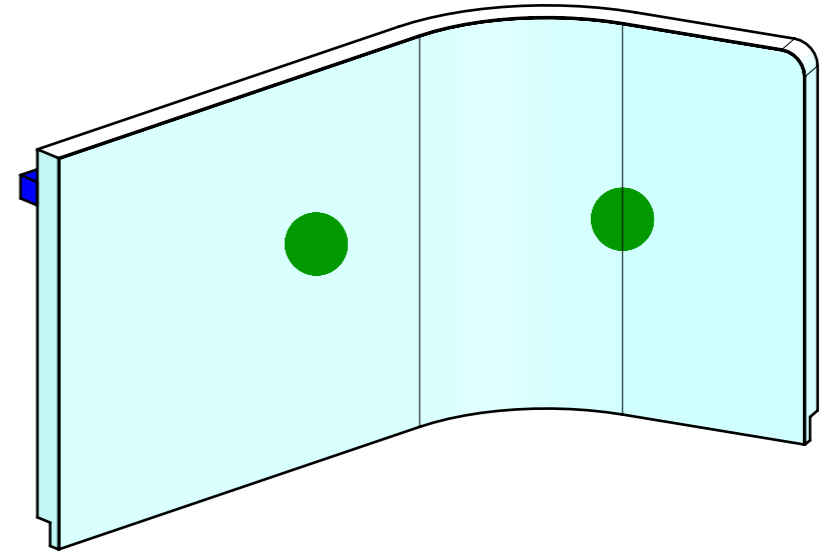
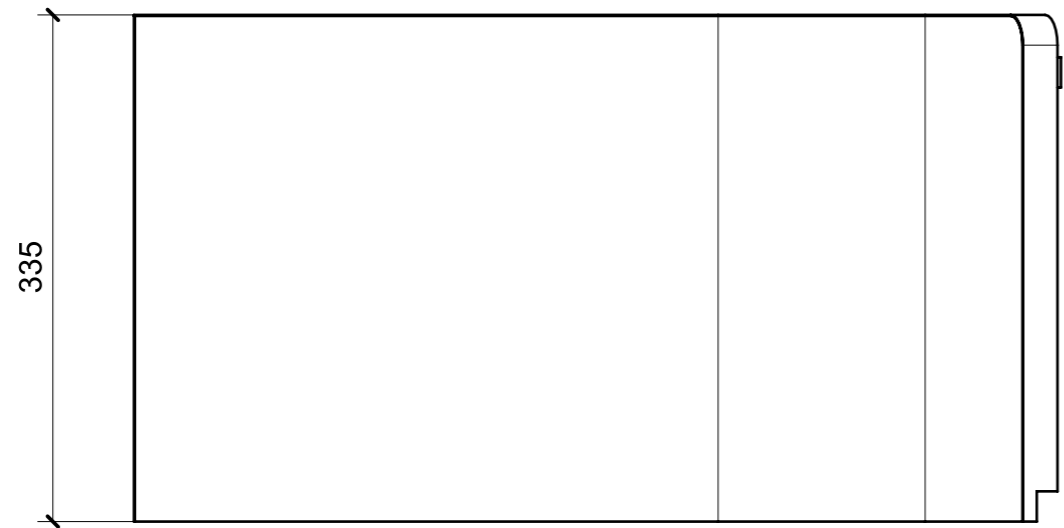

VERNICIATURA LASTRA/LACCATI:

● = VERNICIARE 1 LATO + FILI RASATI O BORDATI

NESSUN SIMBOLO = VERNICIARE 2 LATI + FILI RASATI O BORDATI

LOCALE	CODICE	DESCRIZIONE COMPONENTE	FINITURA	GR.
CABINA VIP	MD321_R01_VG01	NICCHIA SX	LASTRA ALPI JAY STRIPED 12.35	PTP

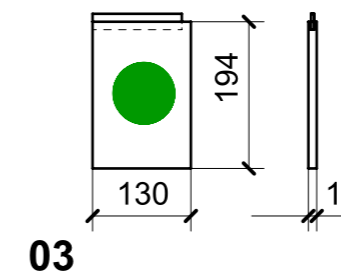
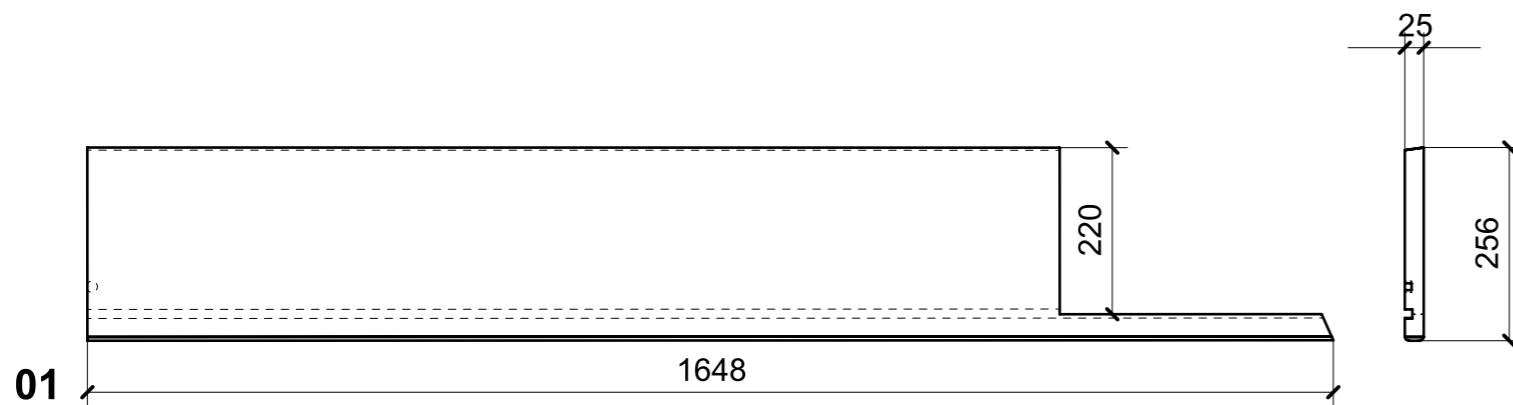

ELEMENTI DA MONTARE  
con acciaio A06 in MF\_VG01  
e spedire con unico imballo

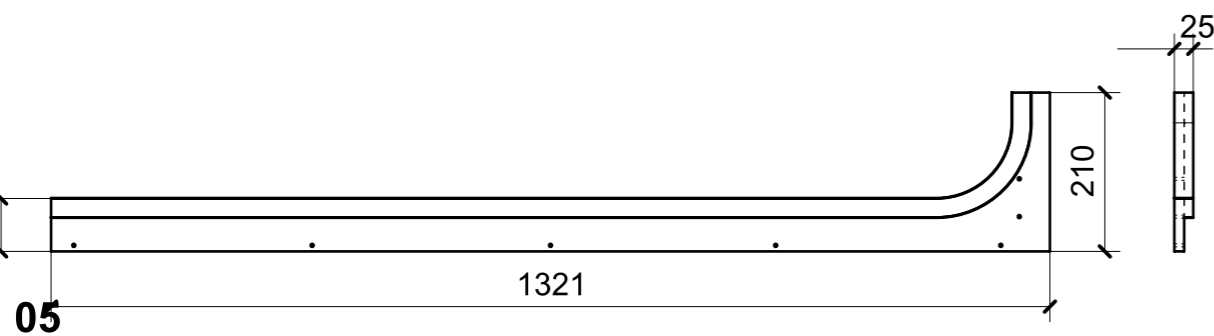
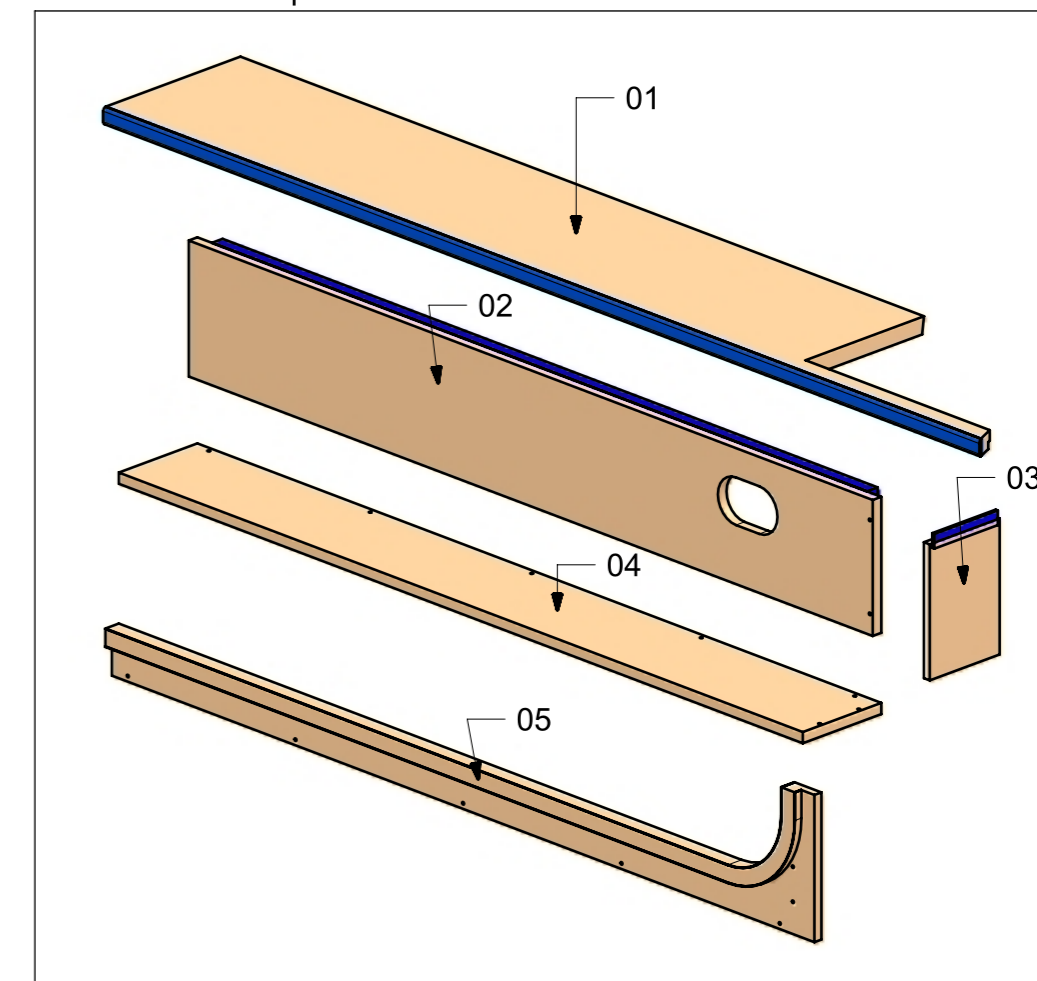
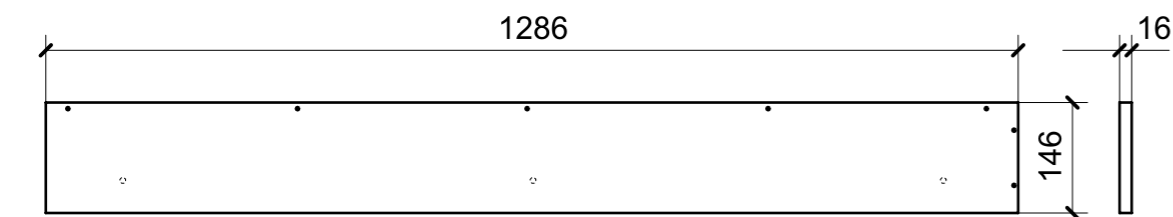
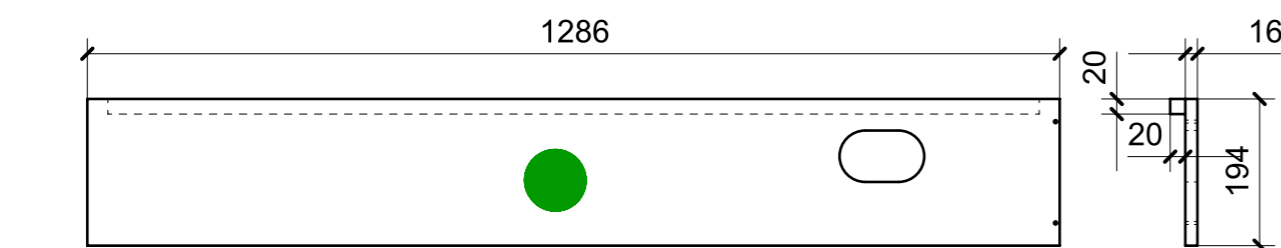
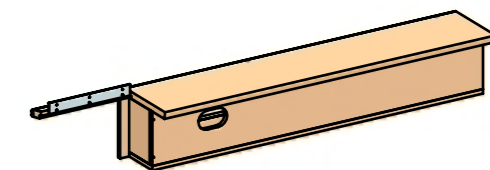

FERRAMENTA	QTY
GIUNTO REGGIRIPIANO CON BORDO ANTISGANCIAMENTO_FBC BORGHI_1033XXB060902	1

VERNICIATURA LASTRA/LACCATI:

● = VERNICIARE 1 LATO + FILI RASATI O BORDATI

NESSUN SIMBOLO = VERNICIARE 2 LATI + FILI RASATI O BORDATI

LOCALE	CODICE	DESCRIZIONE COMPONENTE	FINITURA	GR.
CABINA VIP	MD321_R01_VH01	TESTATA LETTO	LAISTRA ALPI JAY STRIPED 12.35	2

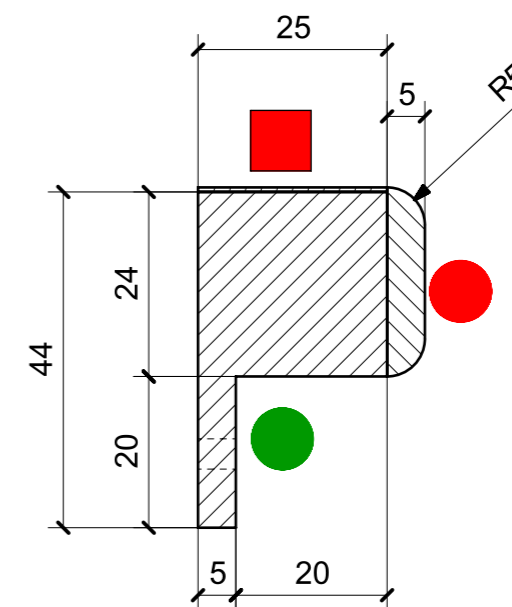
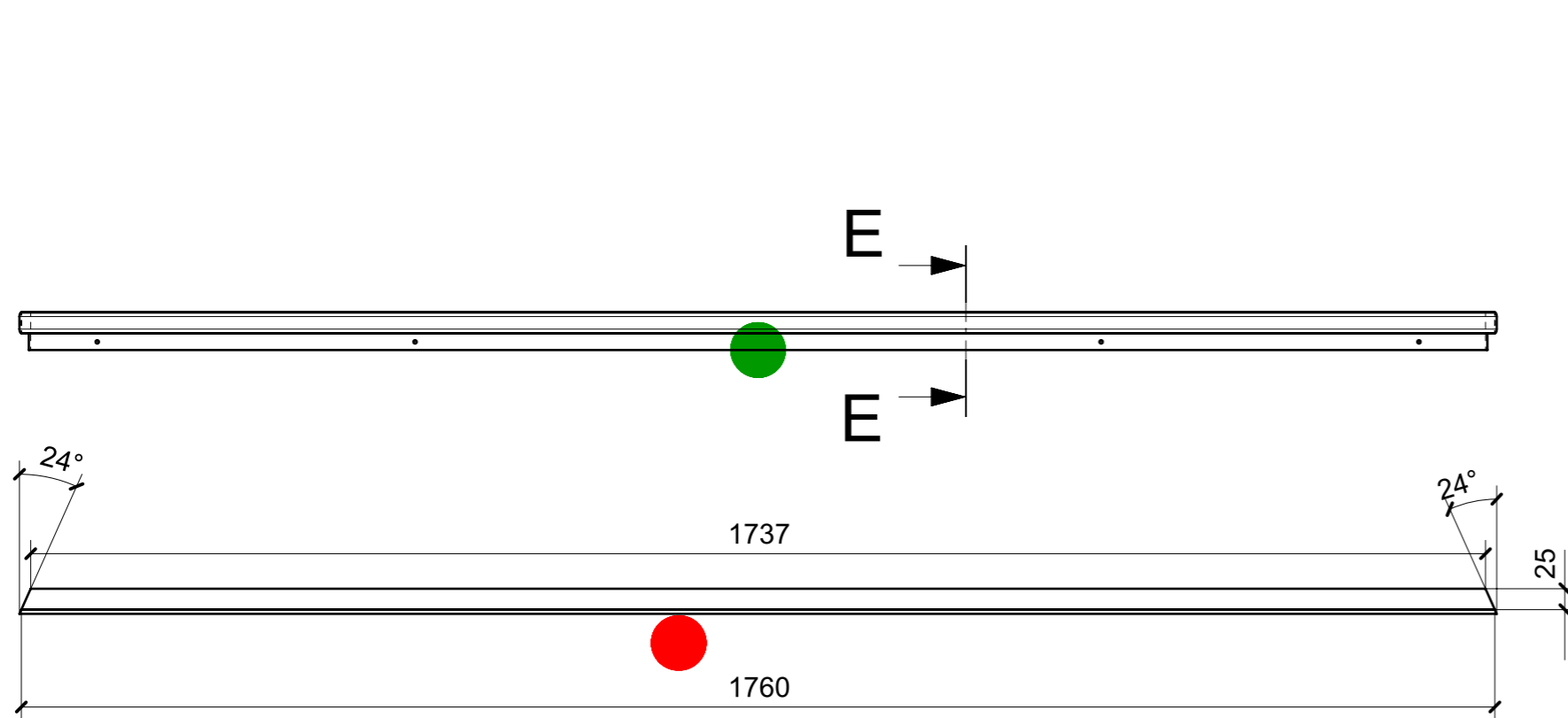

SECTION E-E  
SCALE 1:1

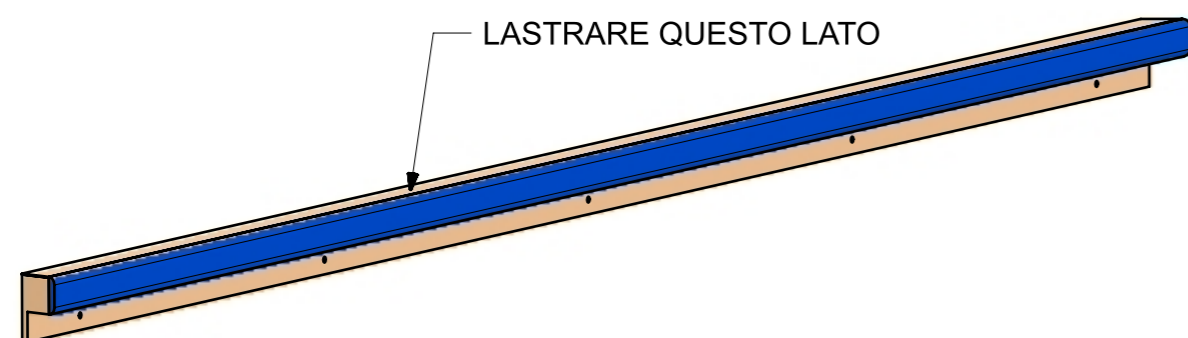

VERNICIATURA LASTRA/LACCATI:

● = VERNICIARE 1 LATO + FILI RASATI O BORDATI

NESSUN SIMBOLO = VERNICIARE 2 LATI + FILI RASATI O BORDATI

LOCALE	CODICE	DESCRIZIONE COMPONENTE	FINITURA	GR.
CABINA VIP	MD321_R01_VI01	LETTO	LASTRA ALPI JAY STRIPED 12.35	2

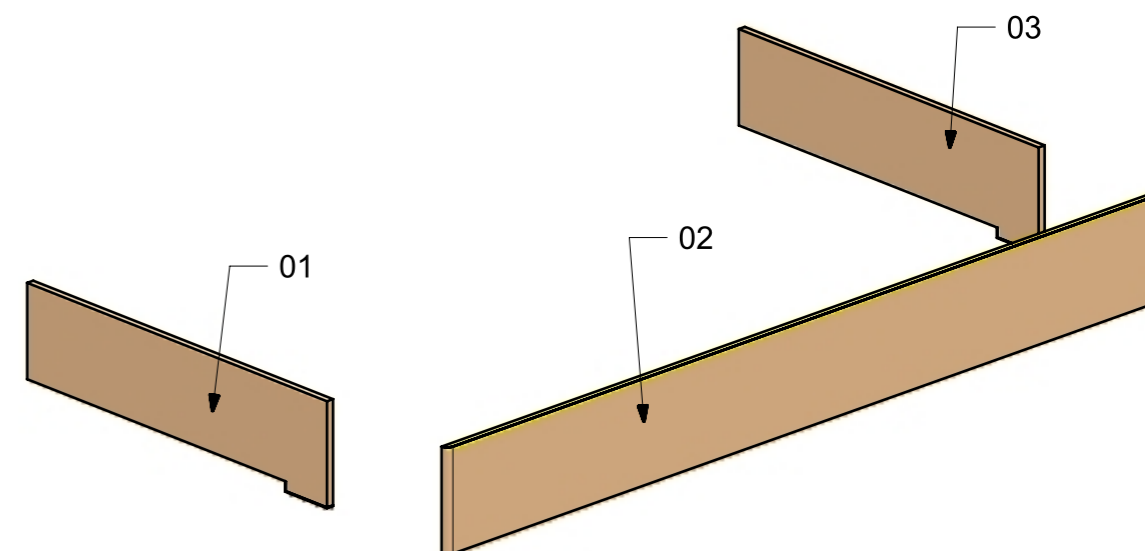
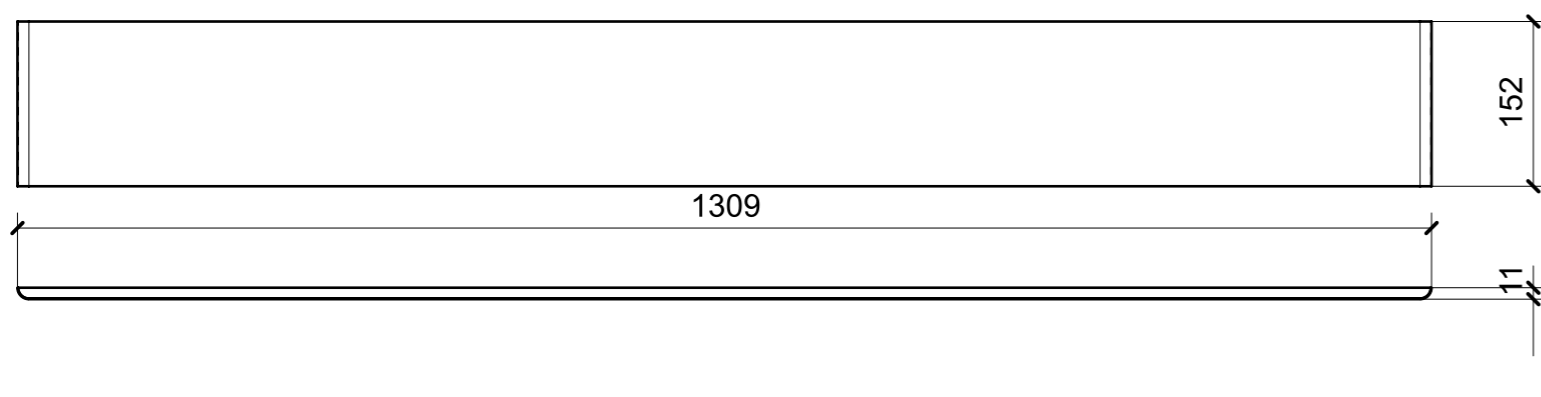
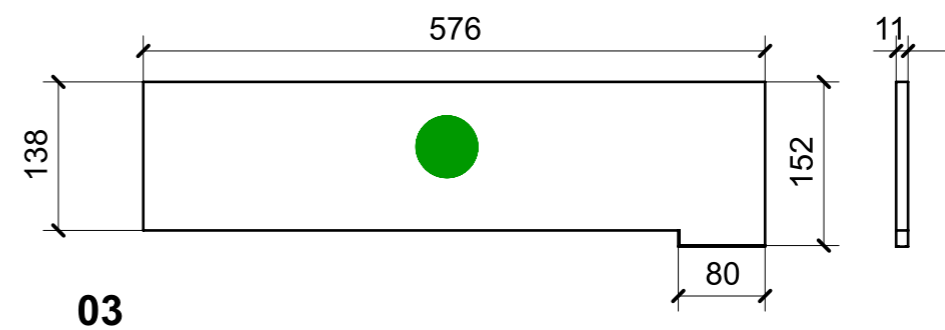
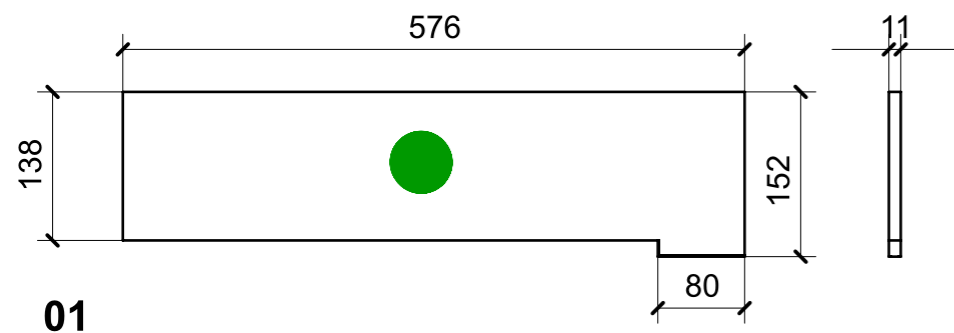

VERNICIATURA LASTRA/LACCATI:

● = VERNICIARE 1 LATO + FILI RASATI O BORDATI

NESSUN SIMBOLO = VERNICIARE 2 LATI + FILI RASATI O BORDATI

LOCALE	CODICE	DESCRIZIONE COMPONENTE	FINITURA	GR.
CABINA VIP	MD321_R01_VL01	NICCHIA DX	LASTRA ALPI JAY STRIPED 12.35	PTP

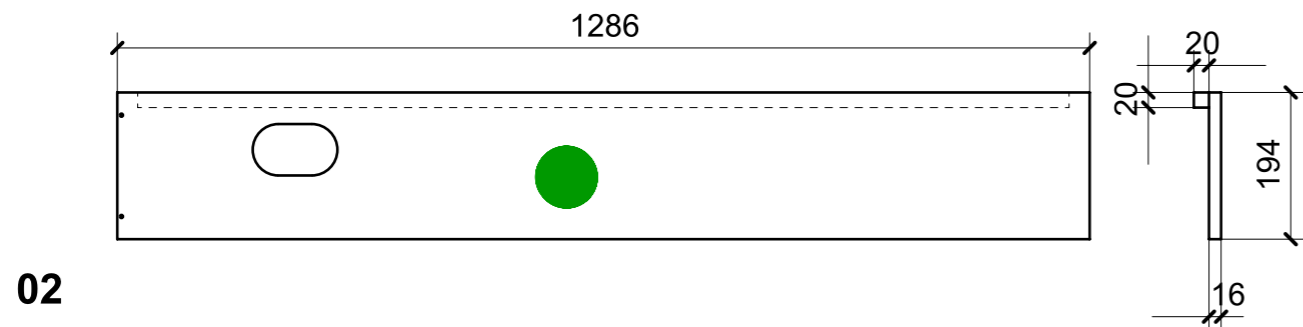
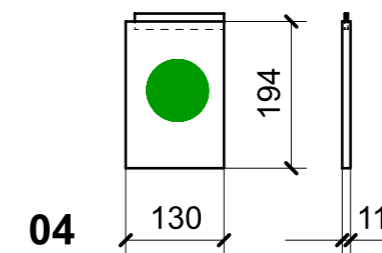
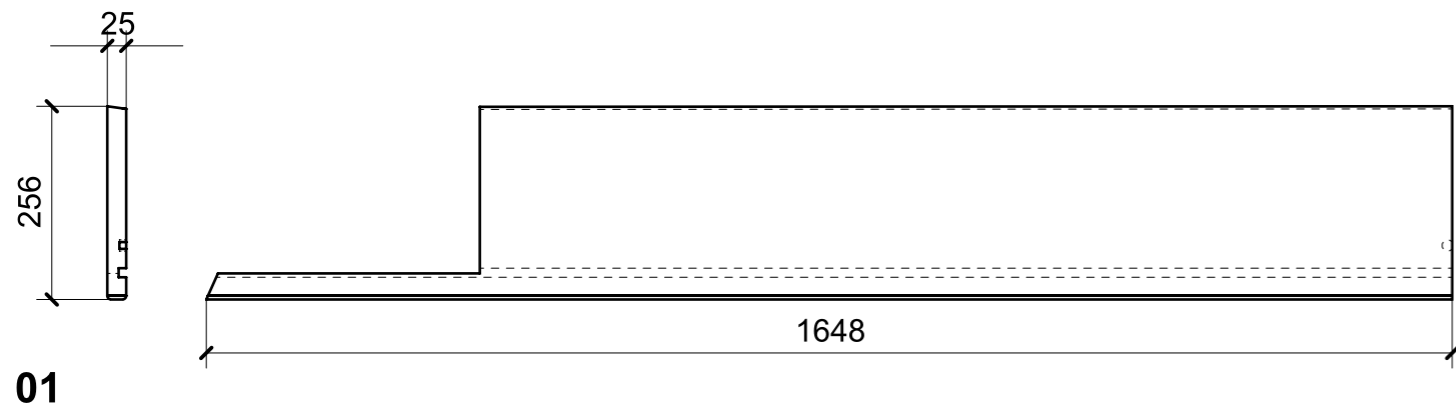

ELEMENTI DA MONTARE  
con acciaio A06 in MF\_VL01  
e spedire con unico imballo

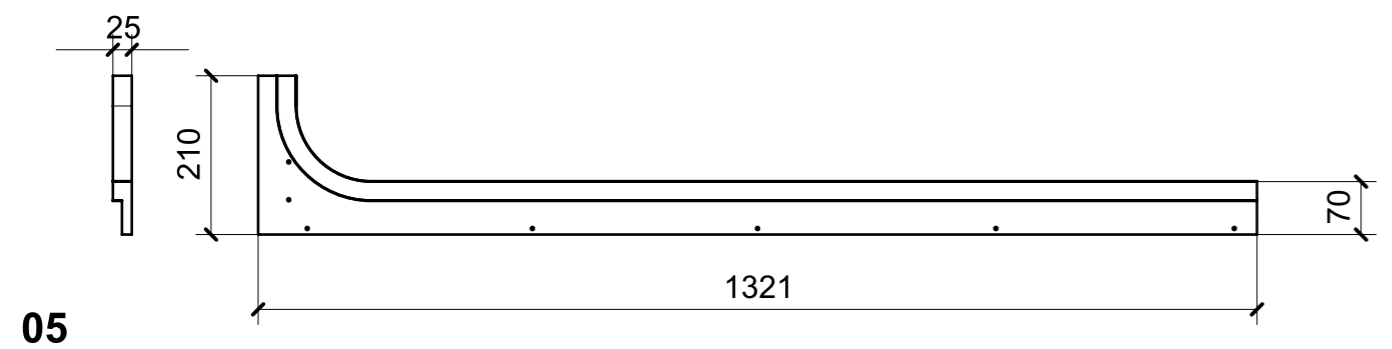
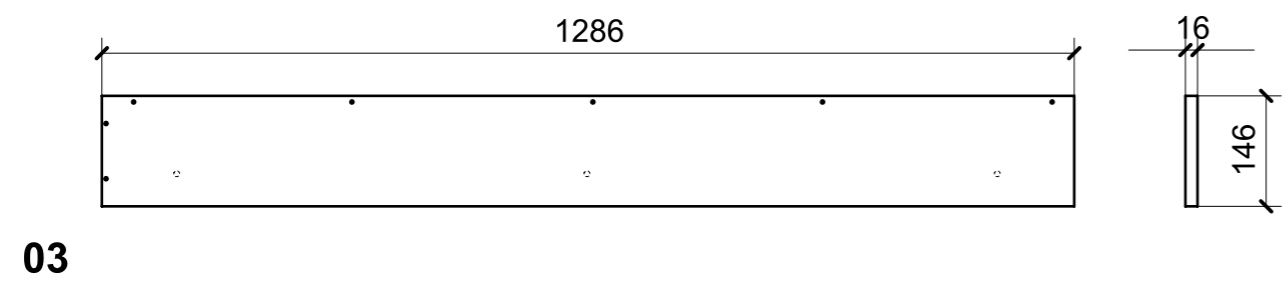
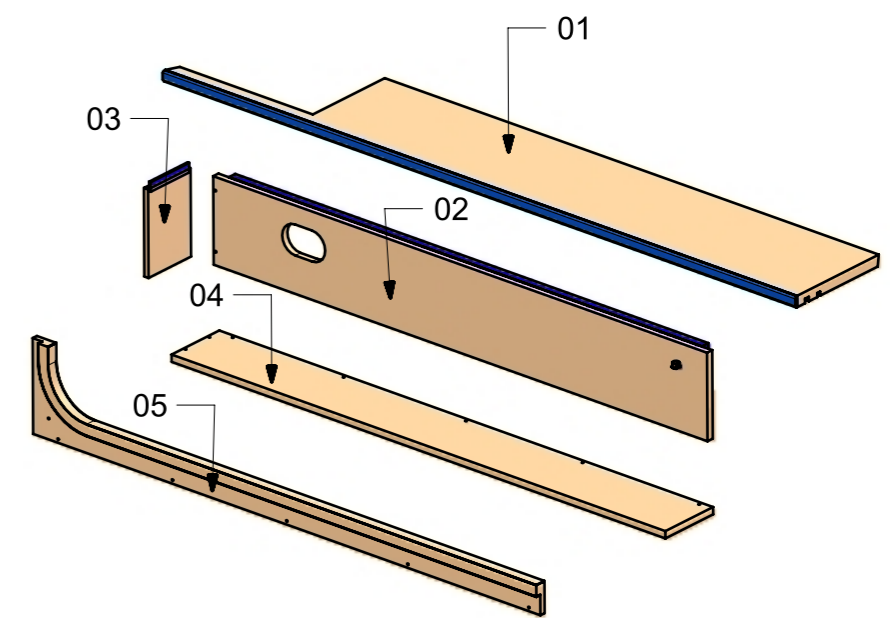

FERRAMENTA	QTY
GIUNTO REGGIRIPIANO CON BORDO ANTISGANCIO_FBC BORGHI_1033XXB060902	1

VERNICIATURA LASTRA/LACCATI:  
● = VERNICIARE 1 LATO + FILI RASATI O BORDATI      NESSUN SIMBOLO = VERNICIARE 2 LATI + FILI RASATI O BORDATI

LOCALE	CODICE	DESCRIZIONE COMPONENTE	FINITURA	GR.
CABINA VIP	MD321_R02_VN01	COMODINO DX	LASTRA ALPI JAY FLAMED 12.34	PTP

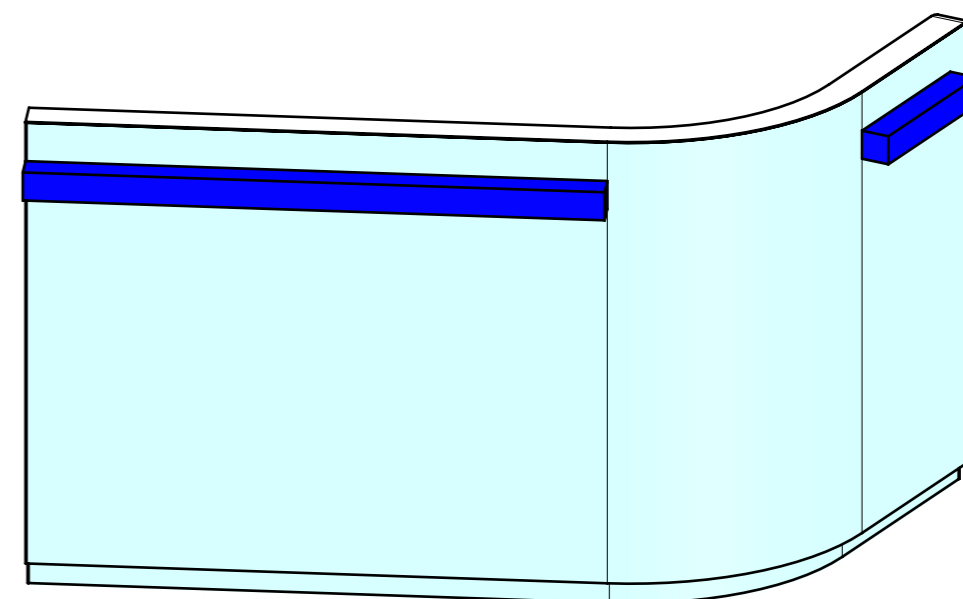
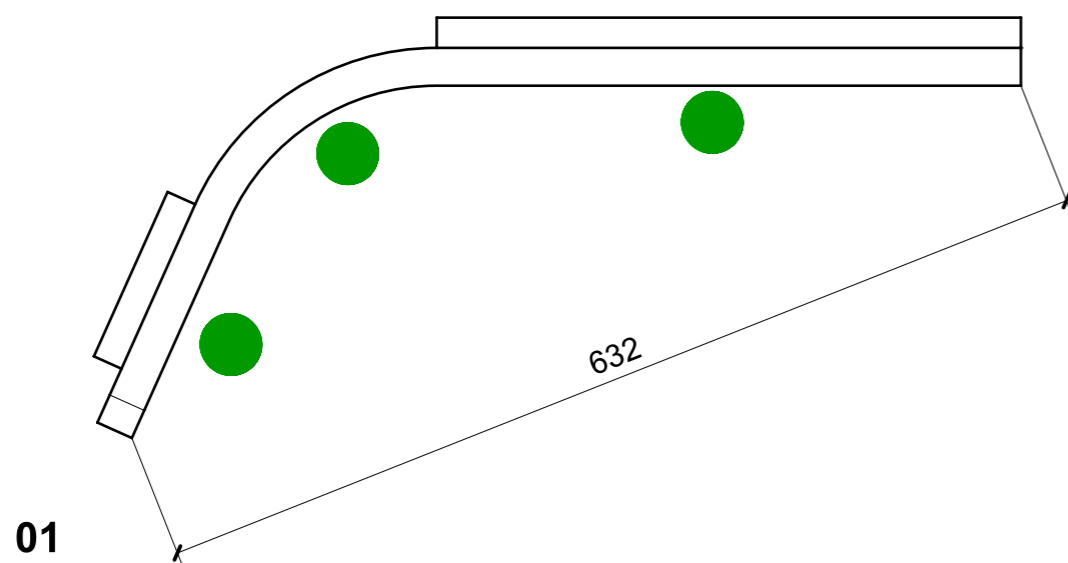
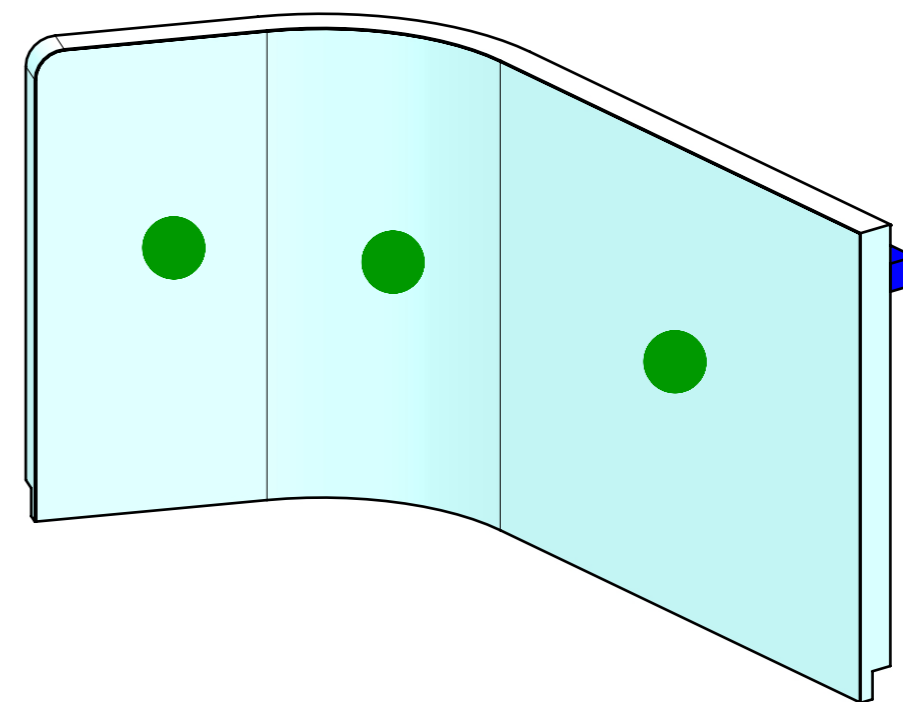
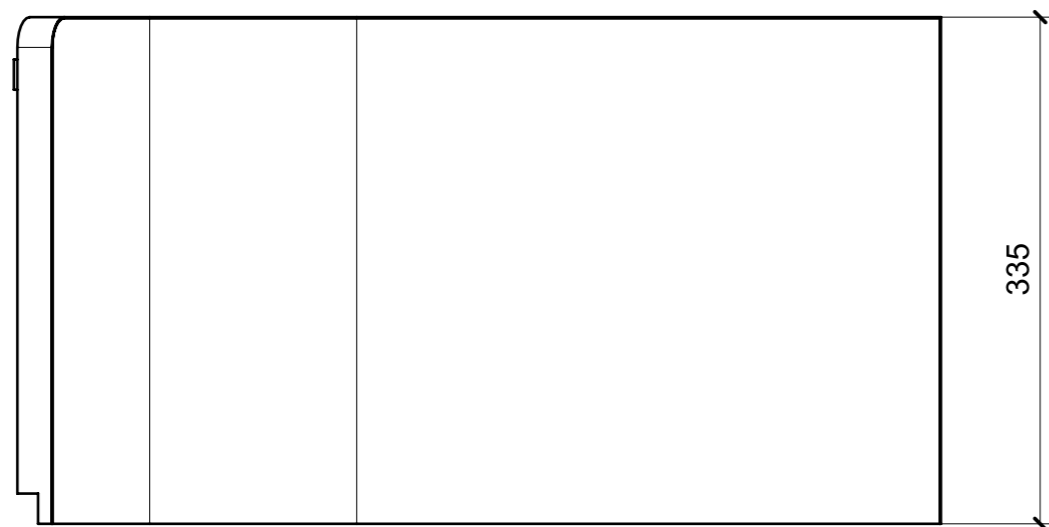

VERNICIATURA LASTRA/LACCATI:

● = VERNICIARE 1 LATO + FILI RASATI O BORDATI

NESSUN SIMBOLO = VERNICIARE 2 LATI + FILI RASATI O BORDATI

LOCALE	CODICE	DESCRIZIONE COMPONENTE	FINITURA	GR.
CABINA VIP	MD321_R01_VO01	PLENUM DX	MDF LASTRATO ALPI JAY STRIPED 12.35	2

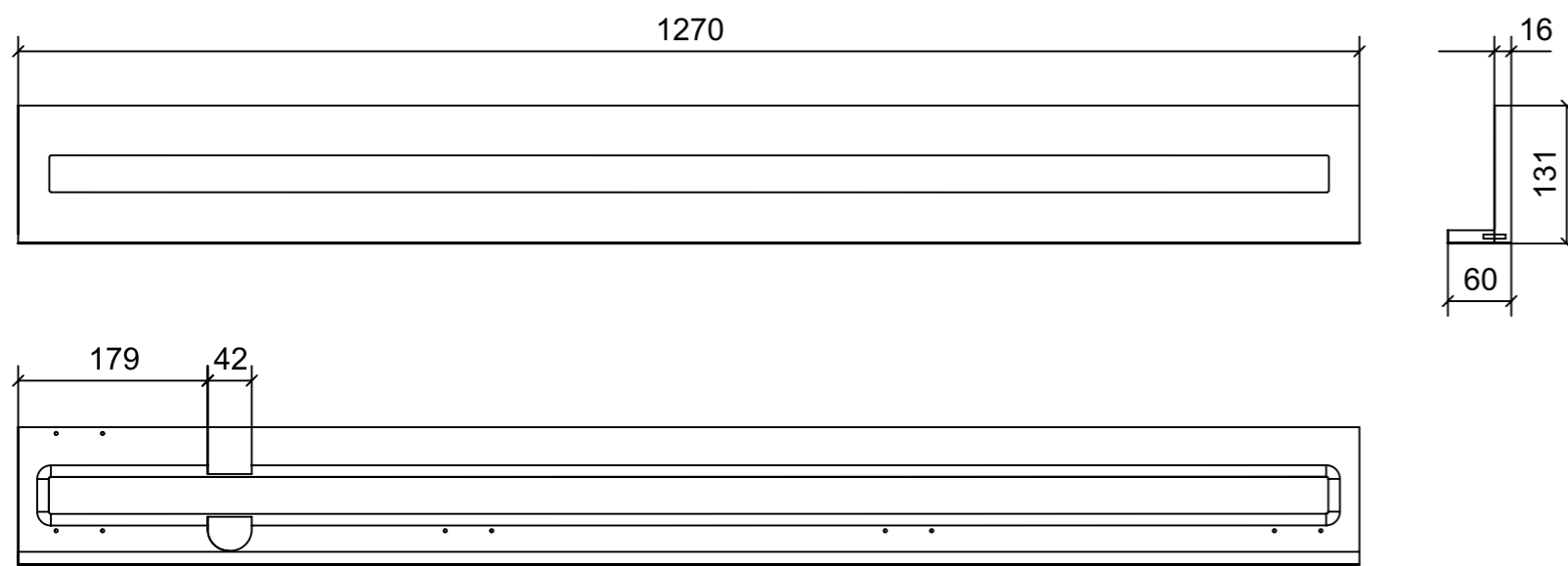

VISTA DAL RETRO

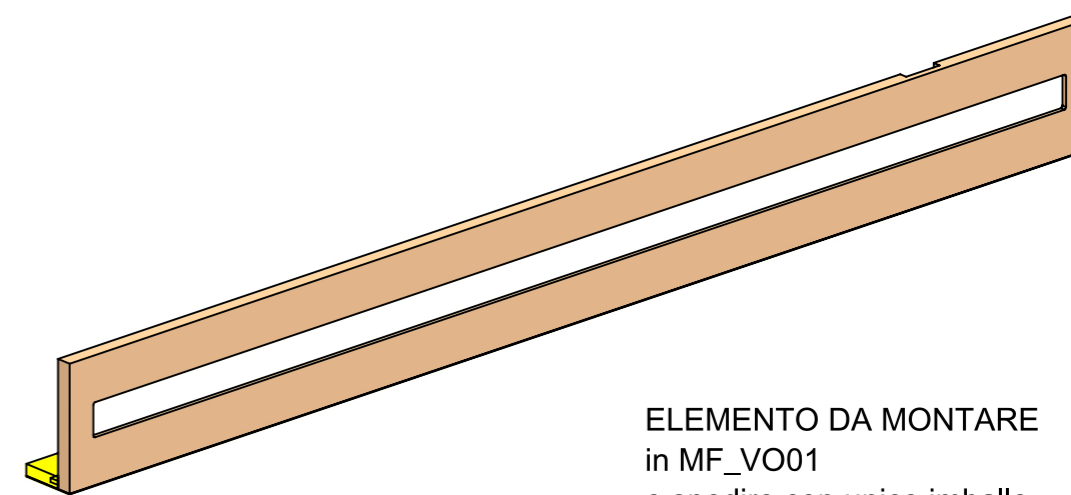

ELEMENTO DA MONTARE  
in MF\_VO01  
e spedire con unico imballo

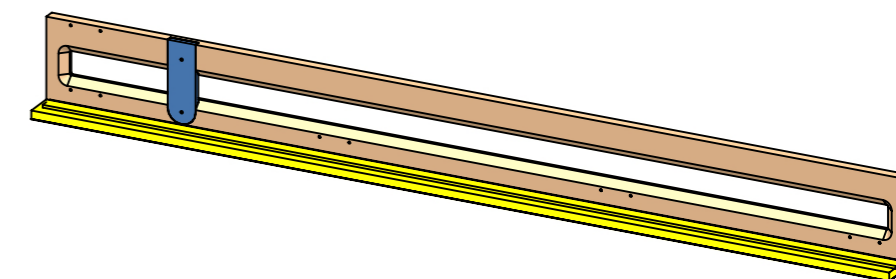

VERNICIATURA LASTRA/LACCATI:

● = VERNICIARE 1 LATO + FILI RASATI O BORDATI

NESSUN SIMBOLO = VERNICIARE 2 LATI + FILI RASATI O BORDATI

LOCALE	CODICE	DESCRIZIONE COMPONENTE	FINITURA	GR.
CABINA VIP	MD321_R01_VQ01	MURATA DX	LASTRA ALPI JAY STRIPED 12.35	2

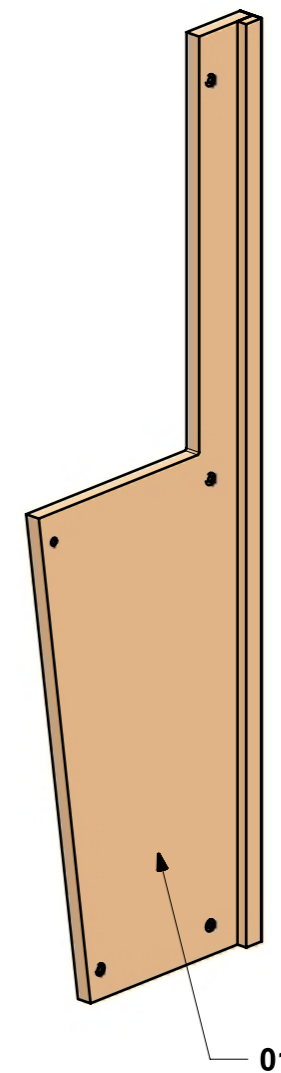
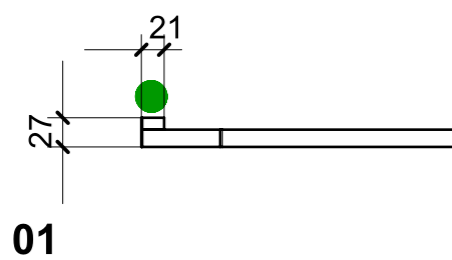
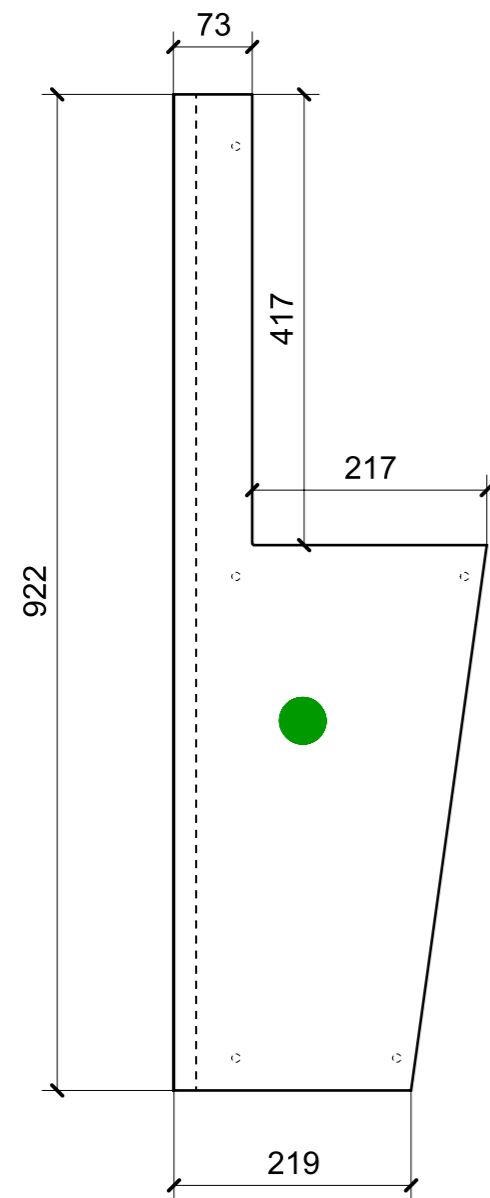

FERRAMENTA	QTY
BUSSOLA 6MA X 10 FORO DIAM.8	5

VERNICIATURA LASTRA/LACCATI:

● = VERNICIARE 1 LATO + FILI RASATI O BORDATI

NESSUN SIMBOLO = VERNICIARE 2 LATI + FILI RASATI O BORDATI

LOCALE	CODICE	DESCRIZIONE COMPONENTE	FINITURA	GR.
CABINA VIP	MD321_R01_VR01	ARMADIO DX	LASTRA ALPI JAY STRIPED 12.35	2

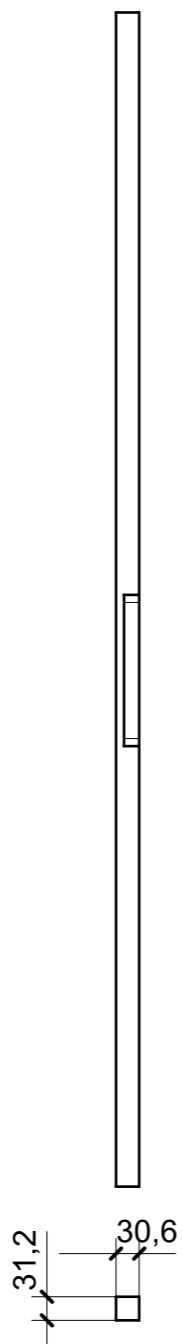
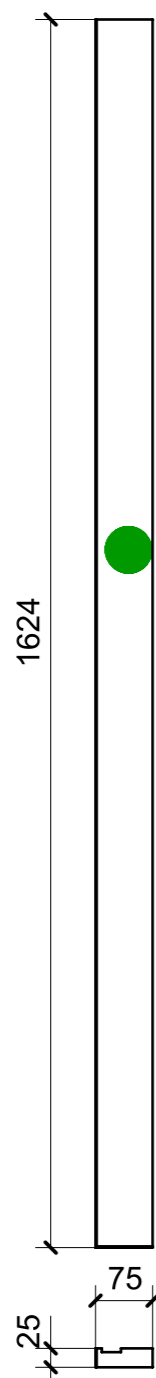
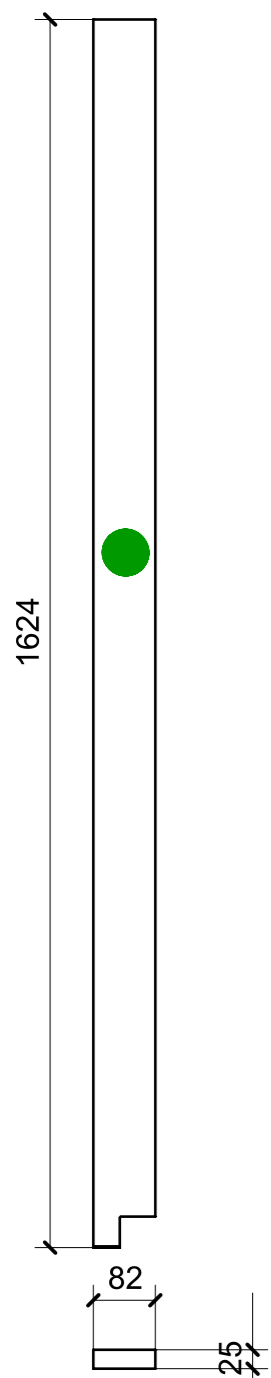
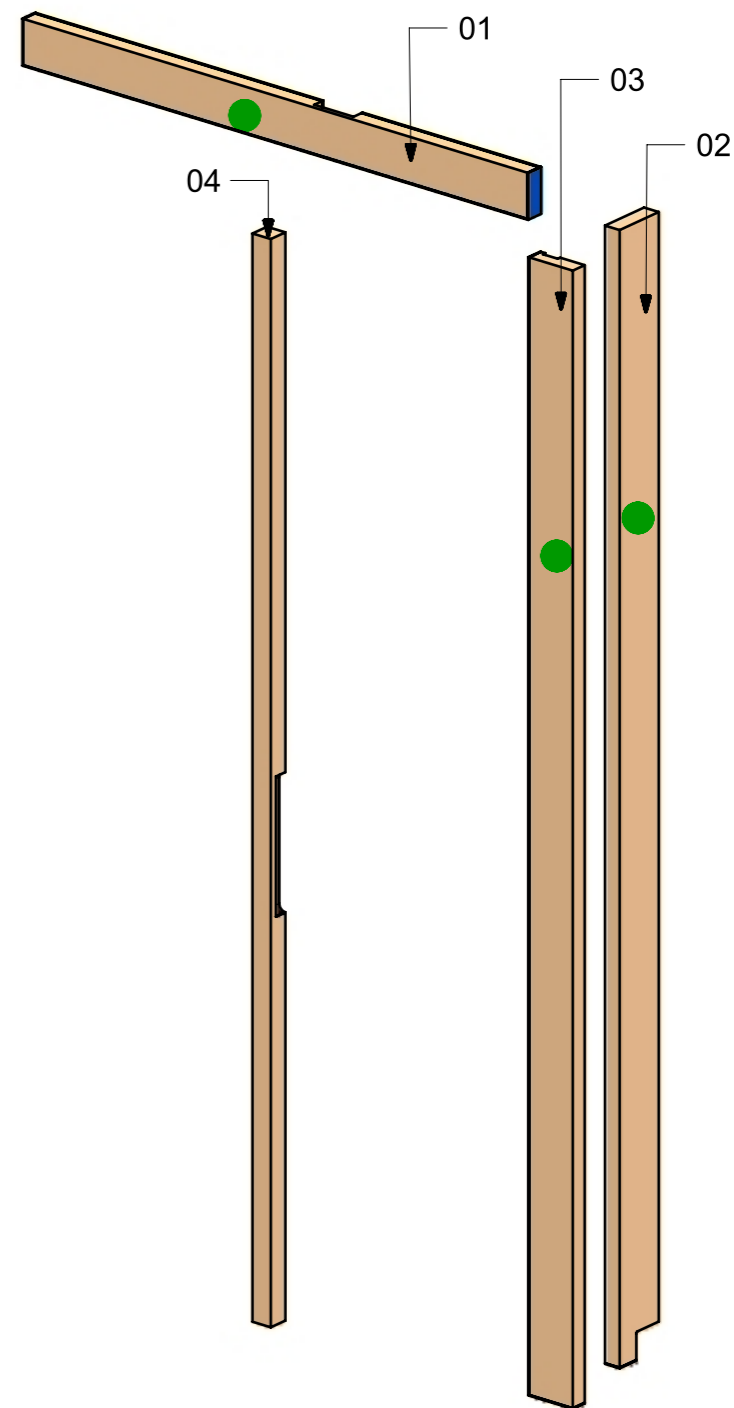
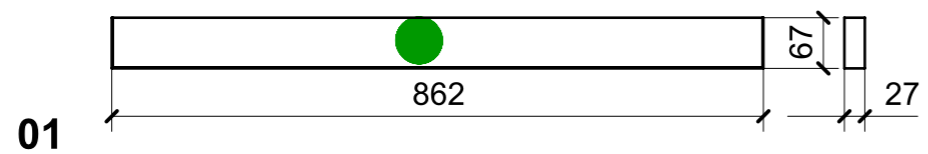

FERRAMENTA	QTY
BUSSOLA 5MA ANKOR BORGHI	4
SENSORE RETROANTA_HAFELE_833_89_334	1
BUSSOLA 6MA X 10 FORO DIAM.8	3

02

03

04

VERNICIATURA LASTRA/LACCATI:

● = VERNICIARE 1 LATO + FILI RASATI O BORDATI

NESSUN SIMBOLO = VERNICIARE 2 LATI + FILI RASATI O BORDATI

LOCALE	CODICE	DESCRIZIONE COMPONENTE	FINITURA	GR.
CABINA VIP	MD321_R02_VR01	ARMADIO DX	LAISTRA ALPI JAY FLAMED 12.34	2

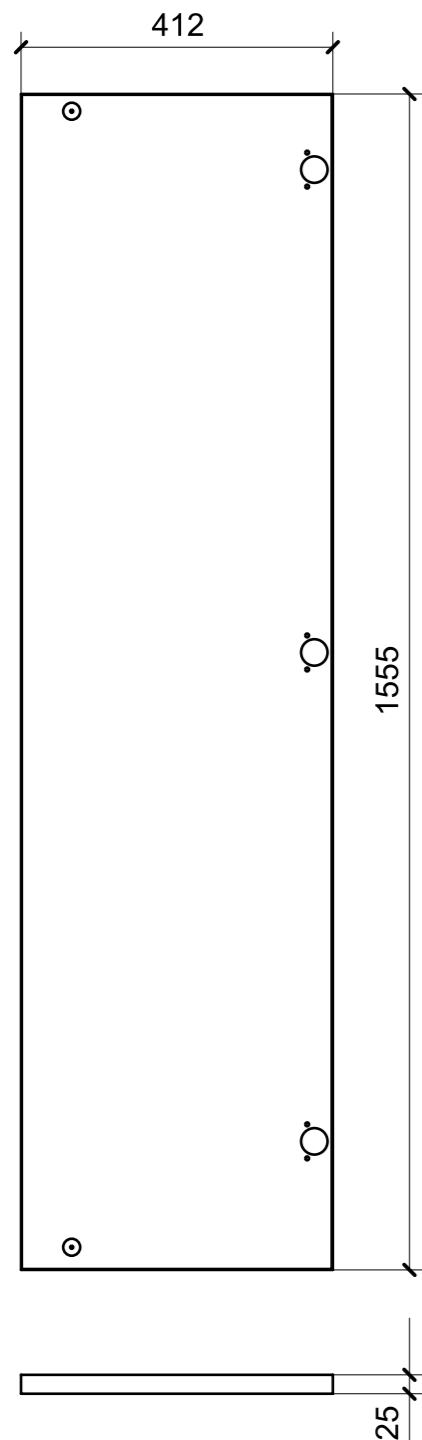

01

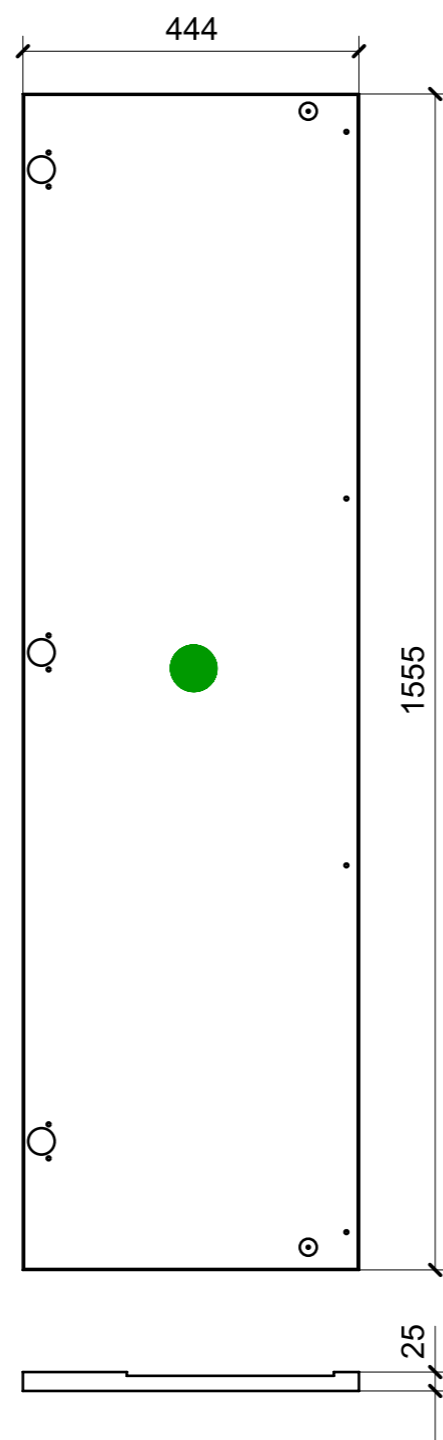

02

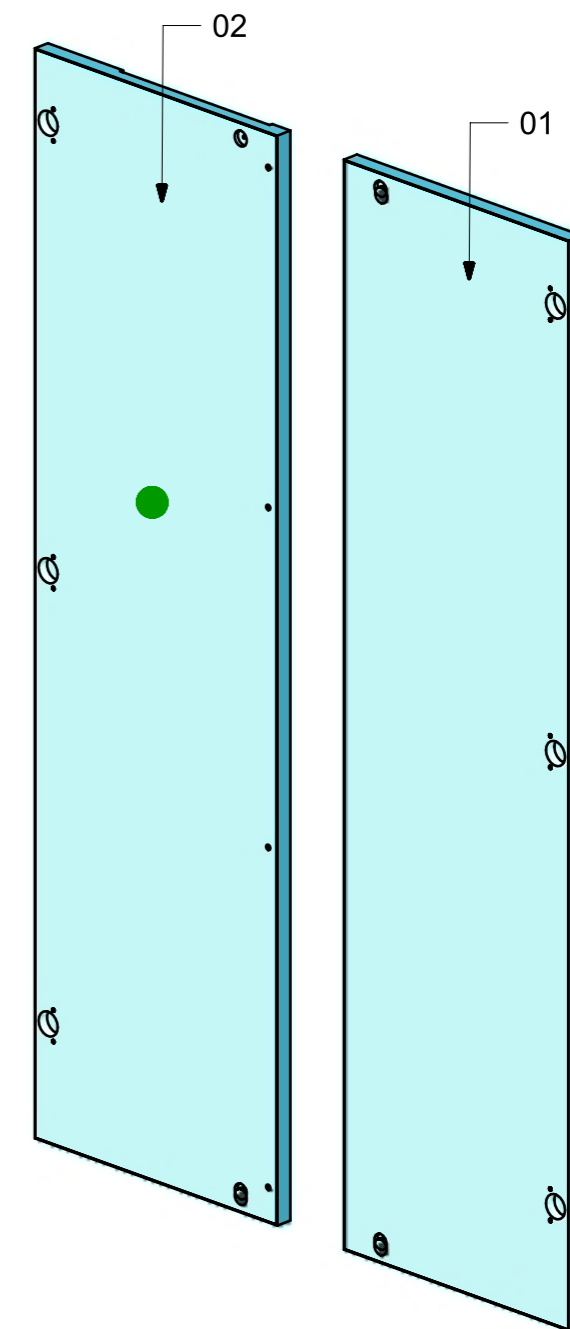

FERRAMENTA	QTY
VITE 4MA X 35 TESTA SVASATA ESAGONALE NERA_FBC_21104	4
MAGNETE FORZA MAGNETICA1-5 10KG_HAFELE_246.87.112	4
BUSSOLA 5MA ANKOR BORGHI X CERNIERA COLLO PIENO	12

VERNICIATURA LASTRA/LACCATI:

● = VERNICIARE 1 LATO + FILI RASATI O BORDATI

NESSUN SIMBOLO = VERNICIARE 2 LATI + FILI RASATI O BORDATI

LOCALE	CODICE	DESCRIZIONE COMPONENTE	FINITURA	GR.
CABINA VIP	MD321_R01_VS01	COLLEG. ARMADIO MURATA DX	LASTRA ALPI JAY STRIPED 12.35	2

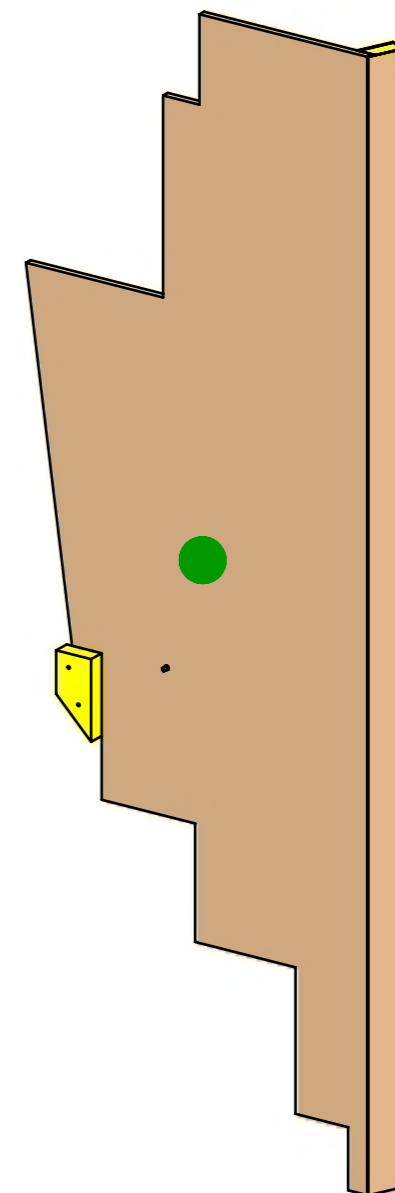
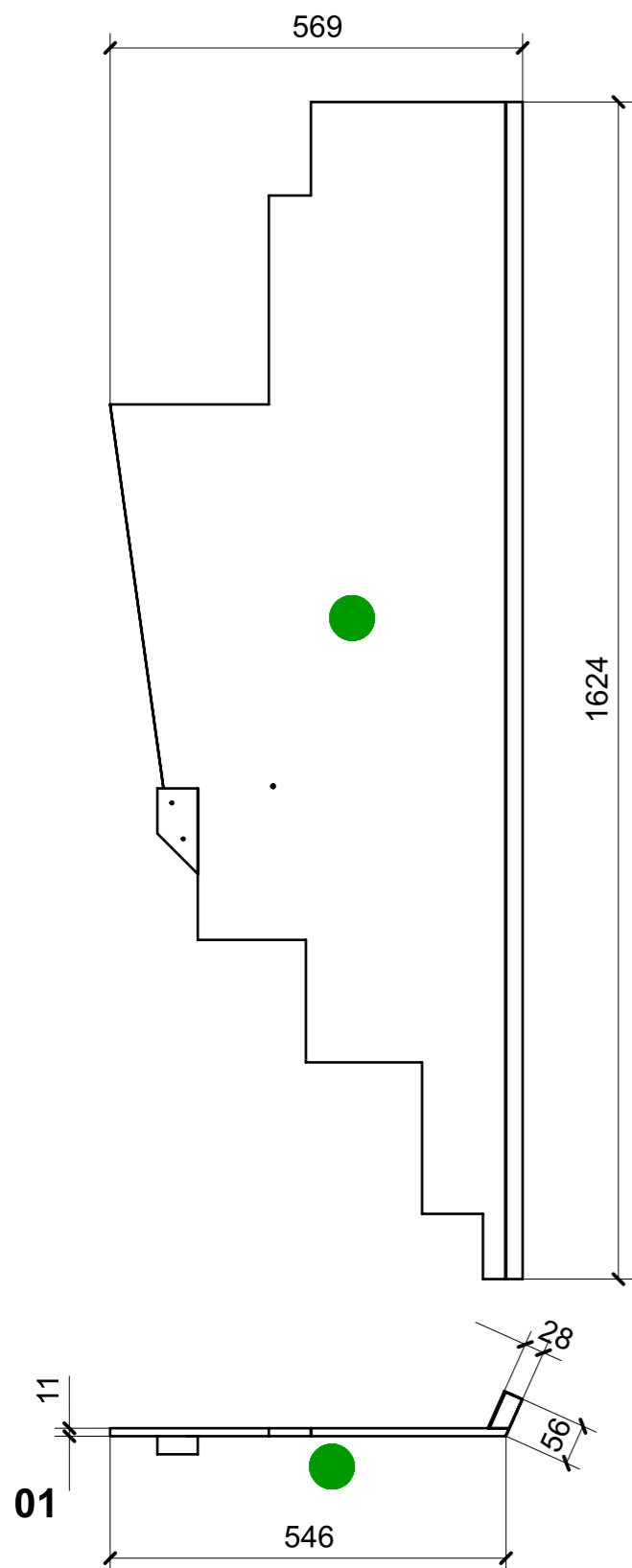

FERRAMENTA	QTY
PERNO LISCIO PER SPALLA_ FBC BORGHI_1033PXX050531	1

VERNICIATURA LASTRA/LACCATI:

● = VERNICIARE 1 LATO + FILI RASATI O BORDATI

NESSUN SIMBOLO = VERNICIARE 2 LATI + FILI RASATI O BORDATI

LOCALE	CODICE	DESCRIZIONE COMPONENTE	FINITURA	GR.
CABINA VIP	MD321_R01_VU01	CIELINI	LASTRA ALPI JAY STRIPED 12.35	2

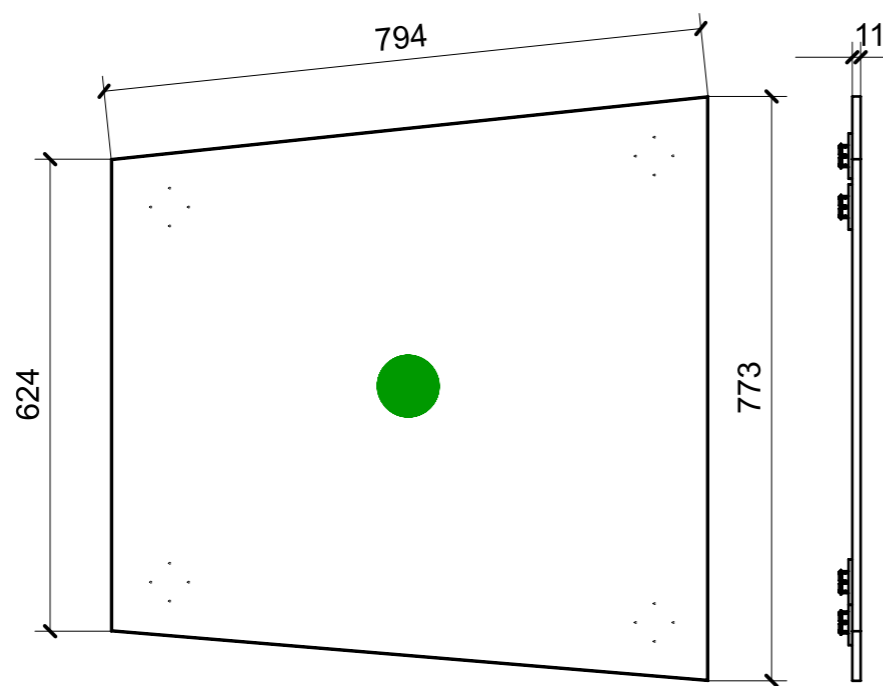

01

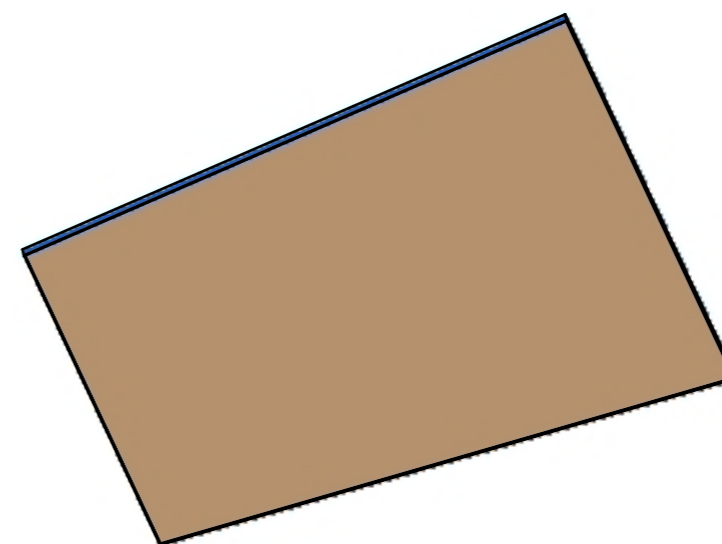

FERRAMENTA	QTY
FITLOCK M_MASCHERPA_5MM_6023030152	4

VERNICIATURA LASTRA/LACCATI:

● = VERNICIARE 1 LATO + FILI RASATI O BORDATI

NESSUN SIMBOLO = VERNICIARE 2 LATI + FILI RASATI O BORDATI