

LOCALE	CODICE	DESCRIZIONE COMPONENTE	FINITURA	GR.
CABINA VIP	MD321_I01_VB01	MURATA SX	OKUME' GREZZO	2

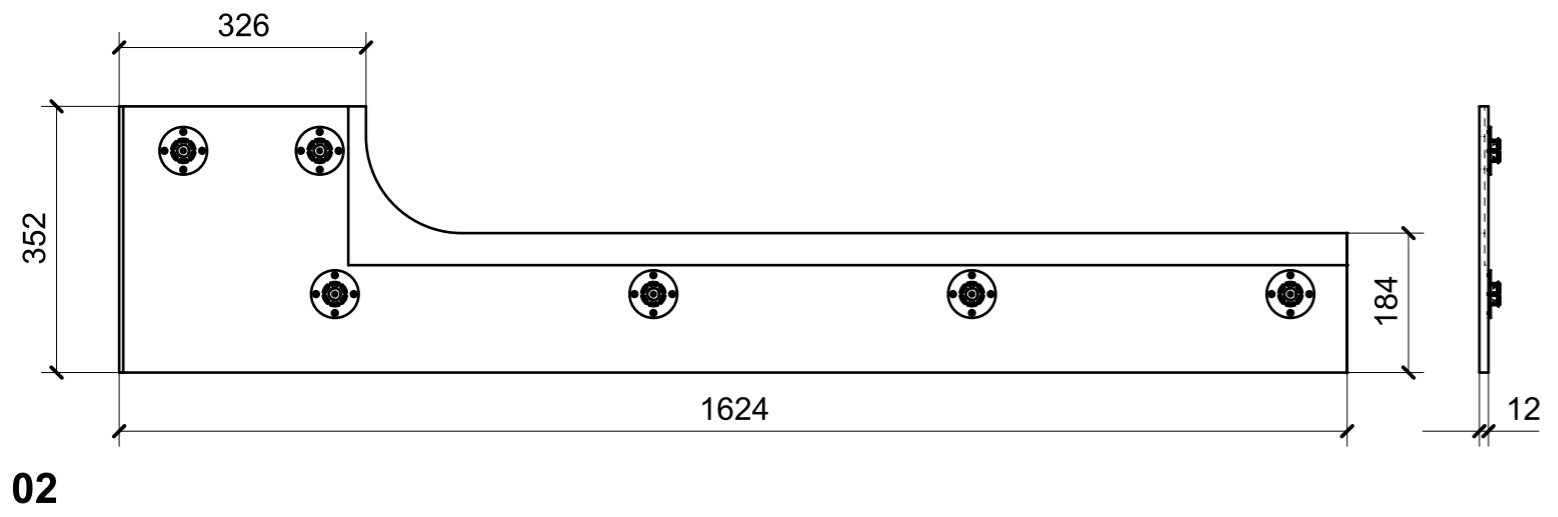

FERRAMENTA	QTY
FITLOCK M_MASCHERPA_3MM_6020202101	6

LOCALE	CODICE	DESCRIZIONE COMPONENTE	FINITURA	GR.
CABINA VIP	MD321_I01_VE01	COMODINO	OKUME' GREZZO	PTP

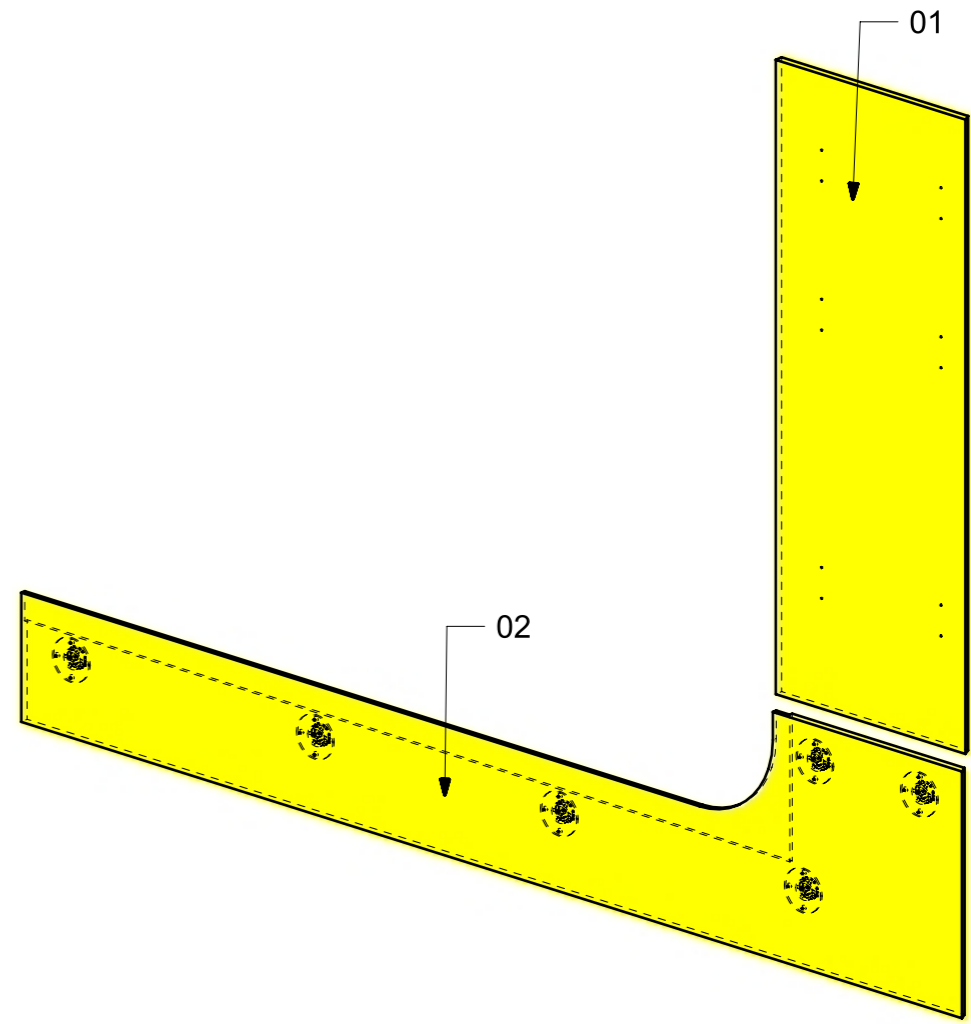
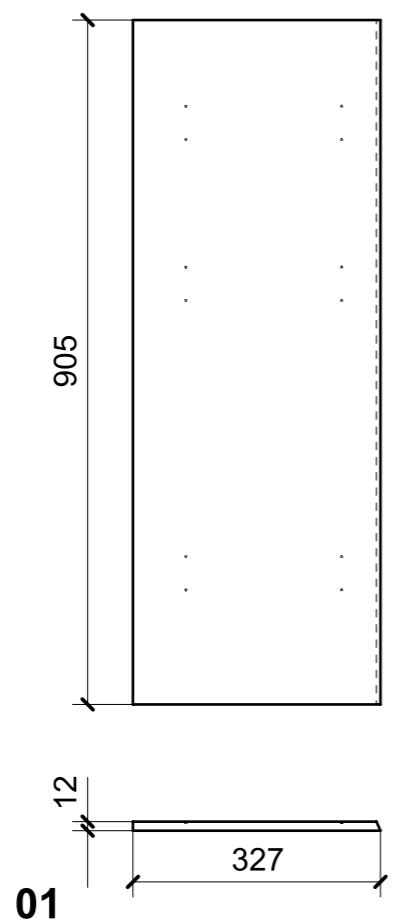
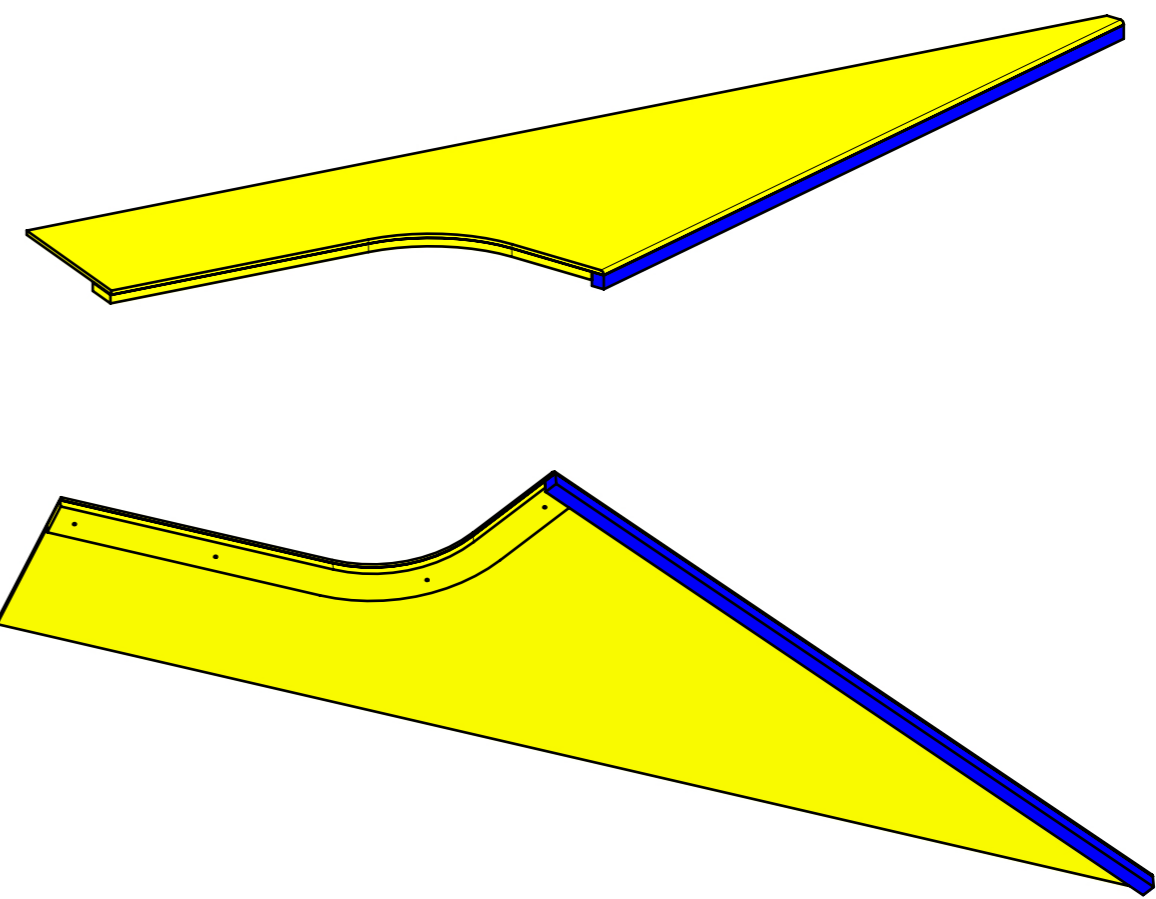
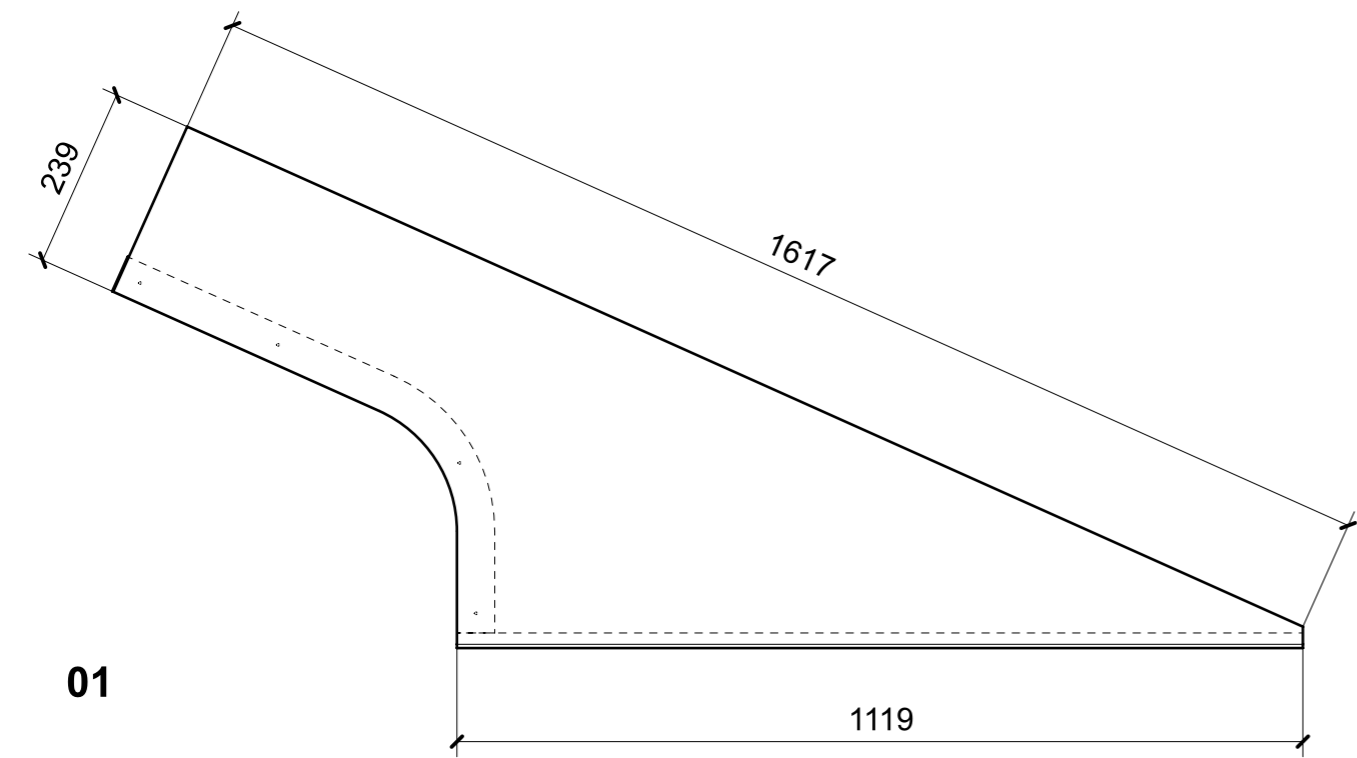
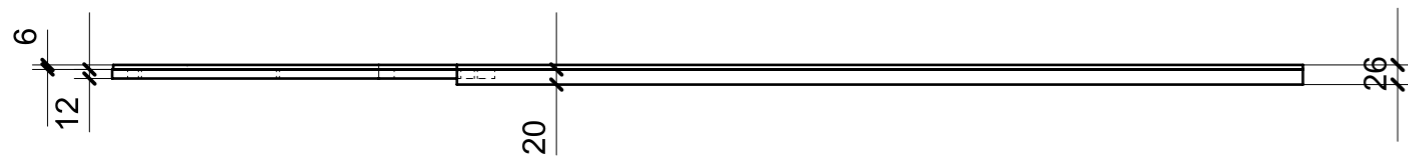

LOCALE	CODICE	DESCRIZIONE COMPONENTE	FINITURA	GR.
CABINA VIP	MD321_I01_VH01	TESTATA LETTO	OKUME' GREZZO	PTP

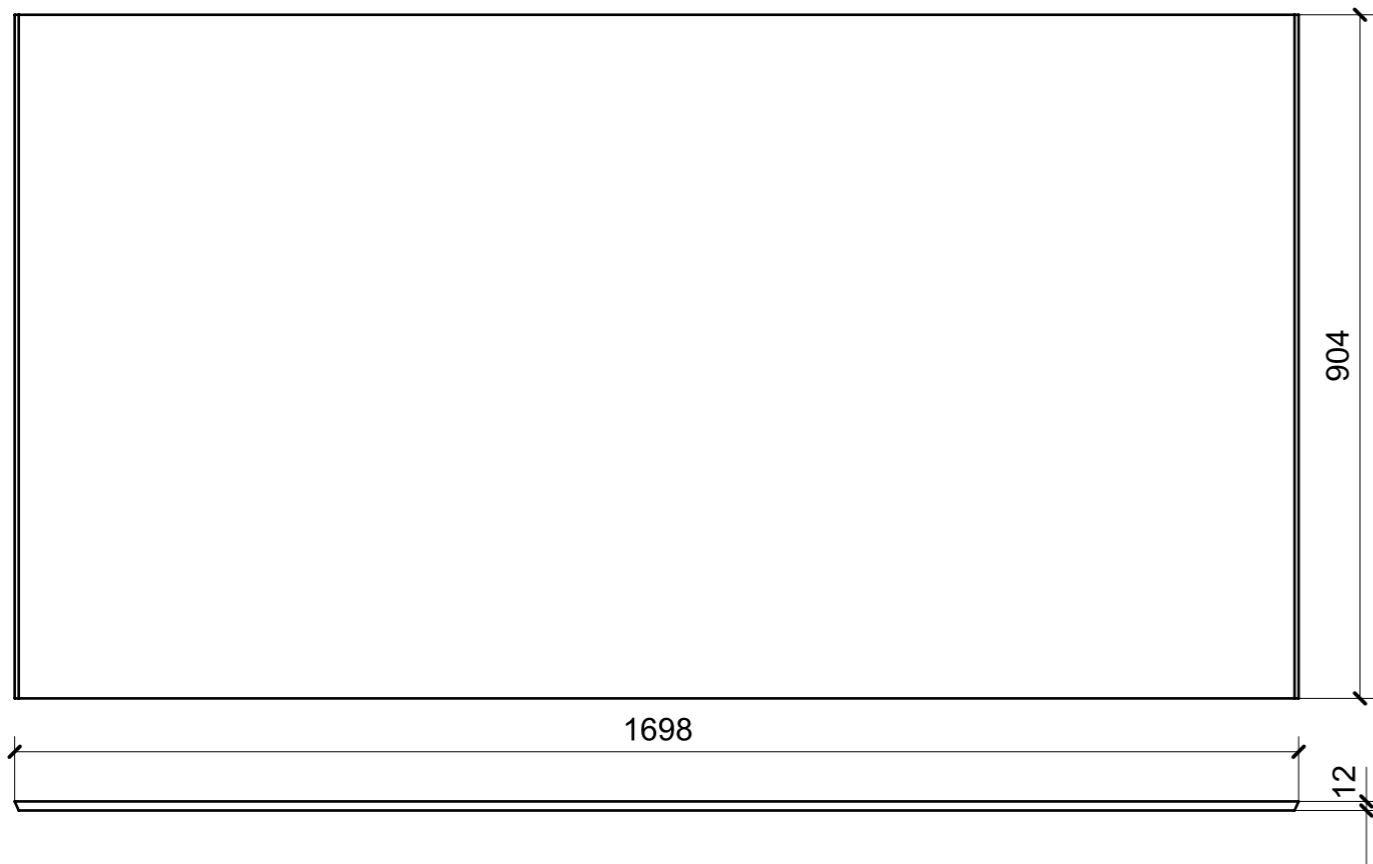

01

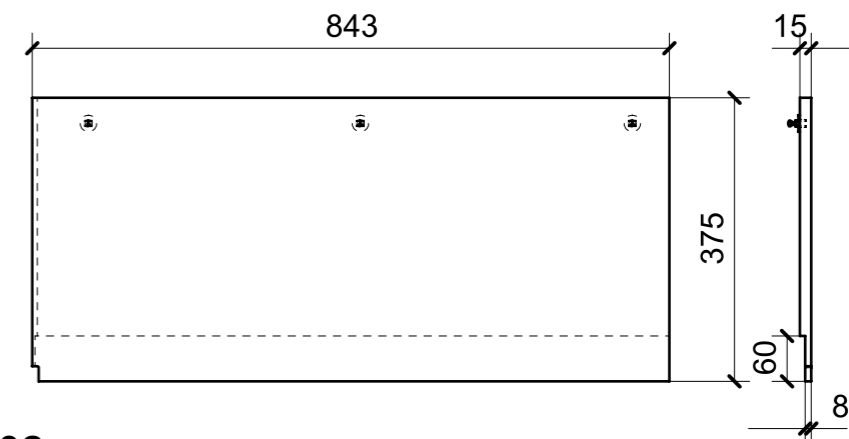

02

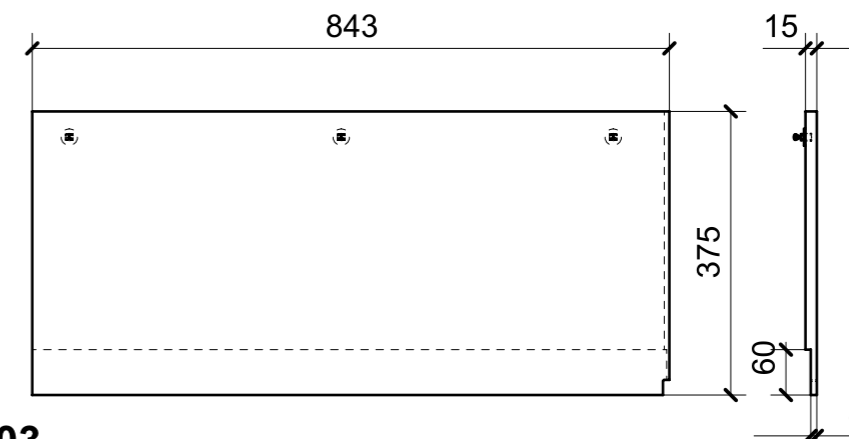

03

FERRAMENTA	QTY
MS INCASSO_ITALVIPLA_972_FMPC_M1B	6

LOCALE	CODICE	DESCRIZIONE COMPONENTE	FINITURA	GR.
CABINA VIP	MD321_I01_VI01	LETTO	OKUME' GREZZO	2

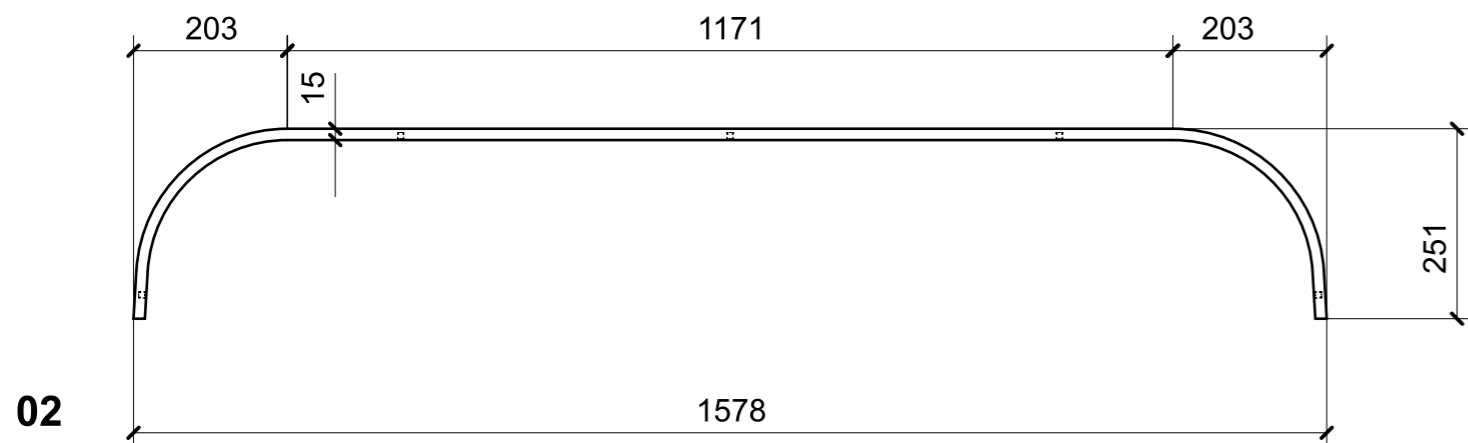
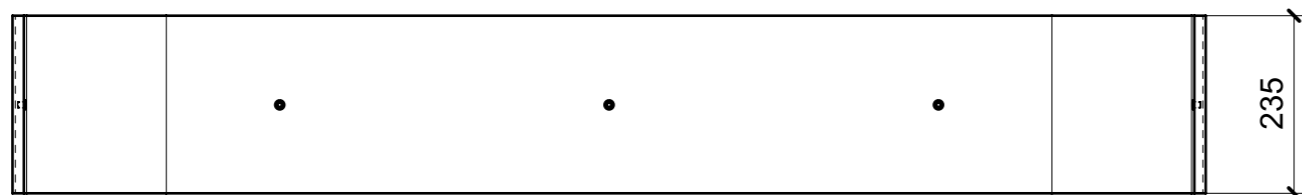

02

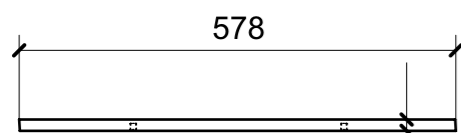
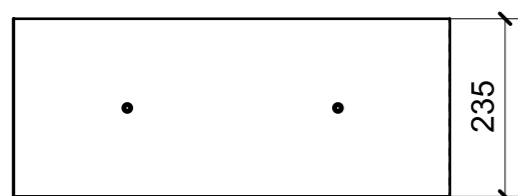

01

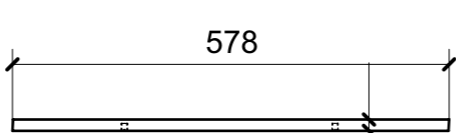
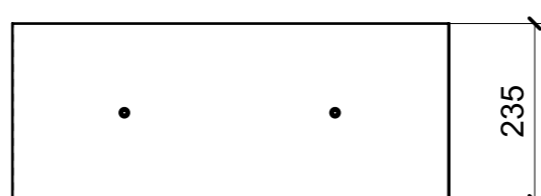

03

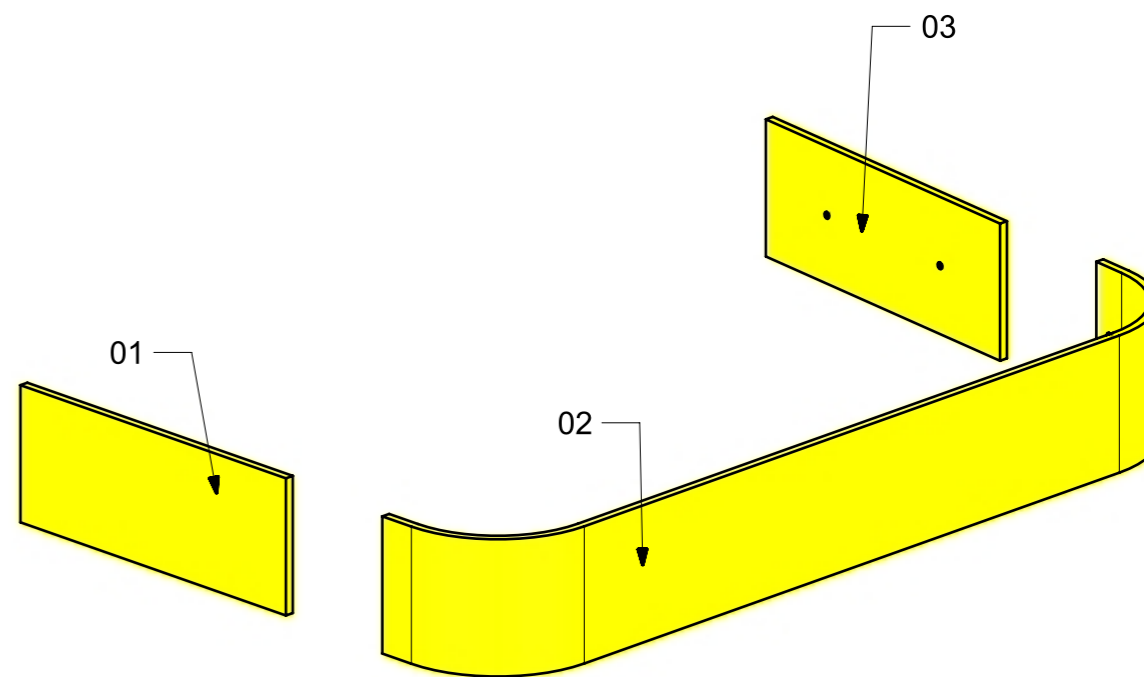

FERRAMENTA	QTY
BUSSOLA 6MA X 10 FORO DIAM.8	9

LOCALE	CODICE	DESCRIZIONE COMPONENTE	FINITURA	GR.
CABINA VIP	MD321_I01_VN01	COMODINO DX	OKUME' GREZZO	PTP

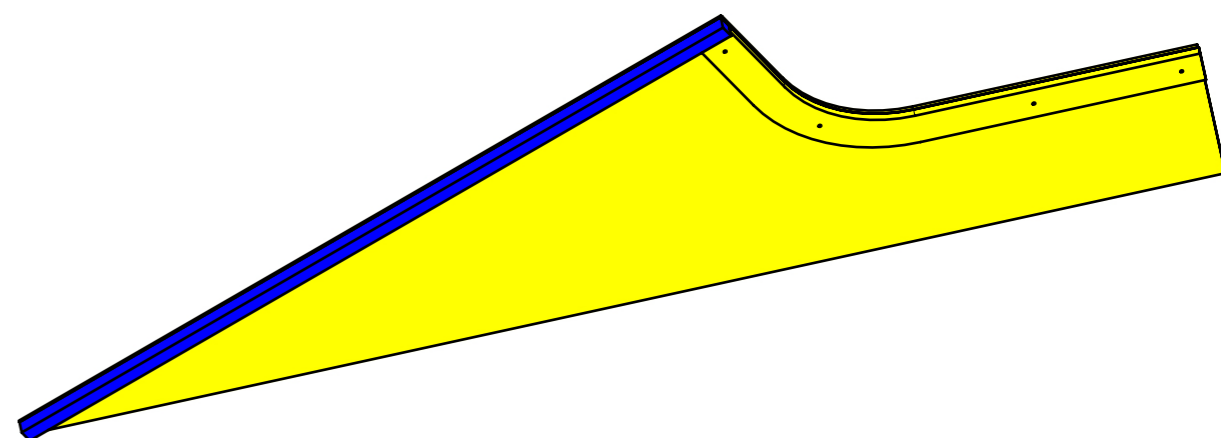
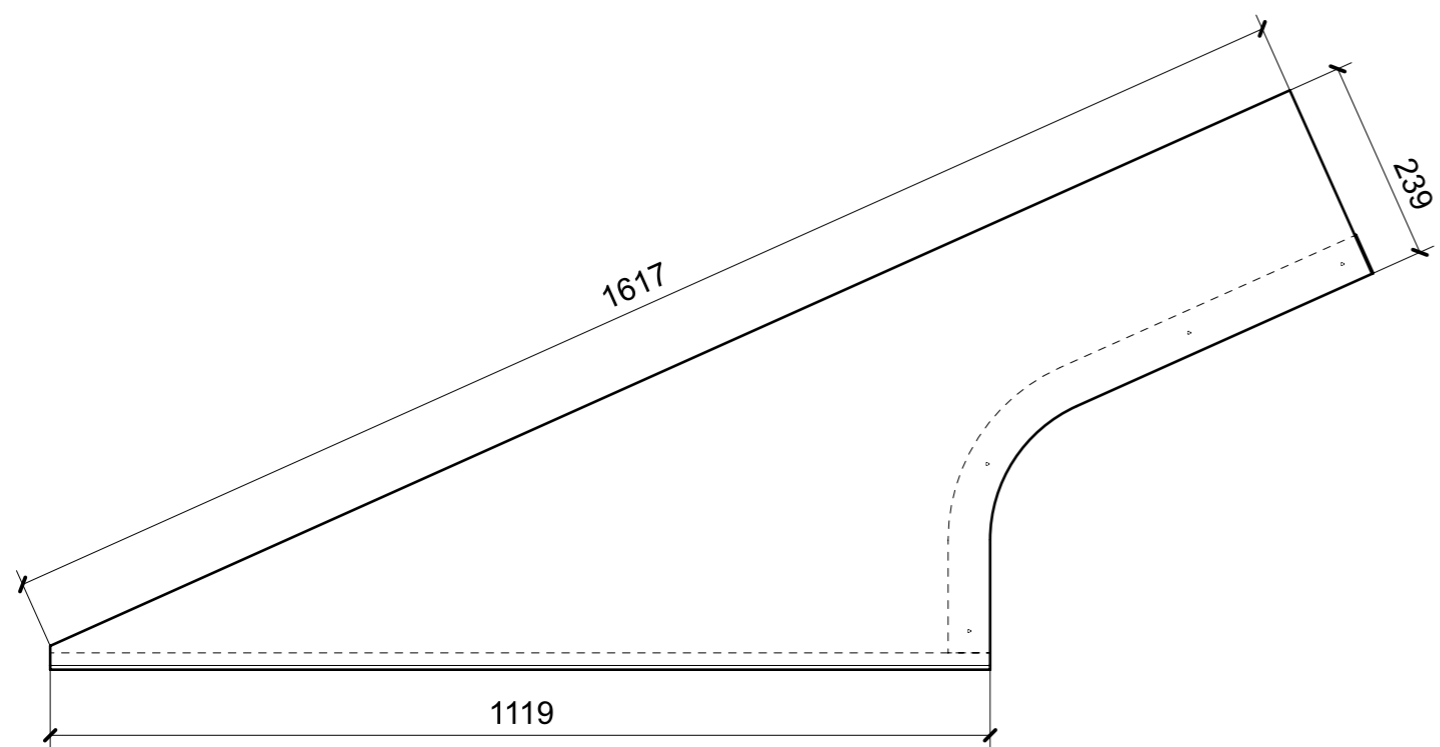
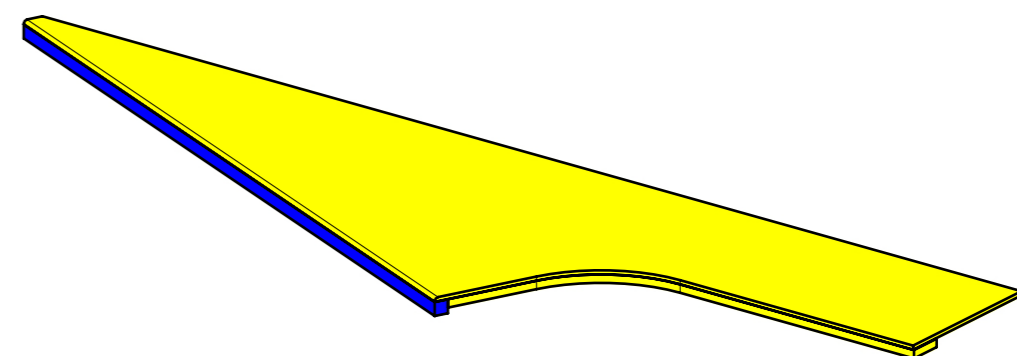
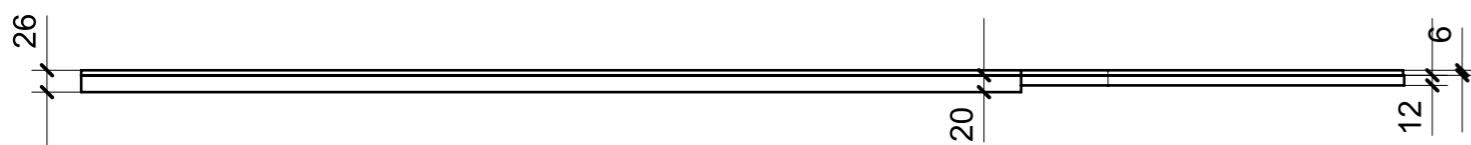

01

LOCALE	CODICE	DESCRIZIONE COMPONENTE	FINITURA	GR.
CABINA VIP	MD321_I01_VQ01	MURATA DX	OKUME' GREZZO	2

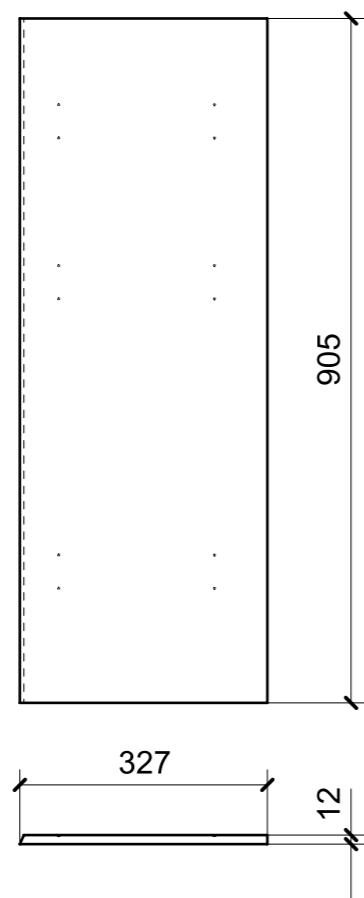

01

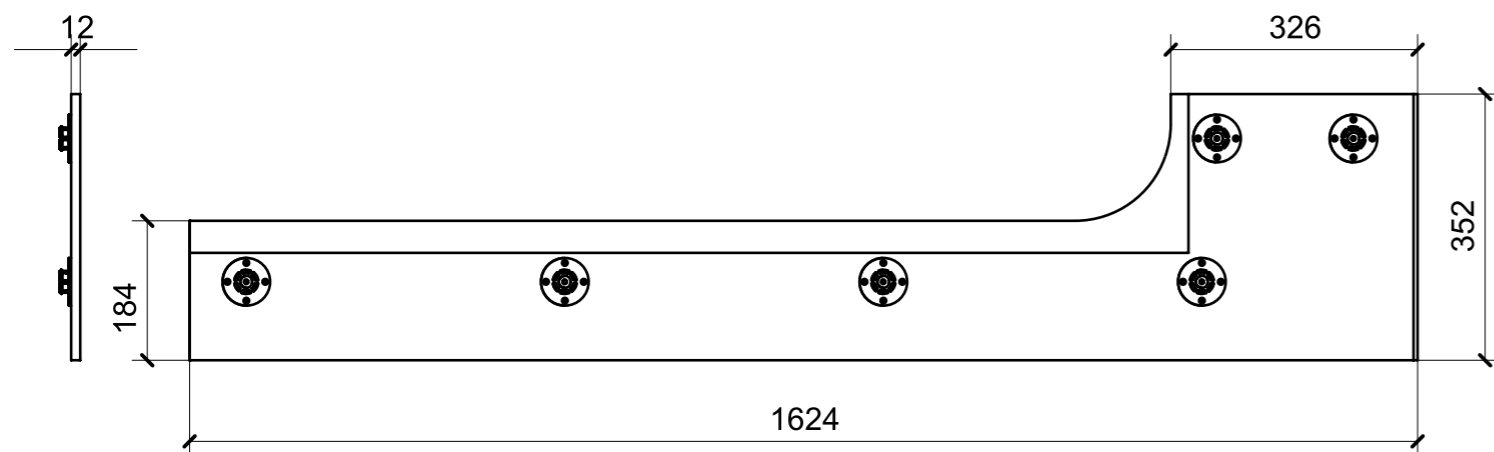
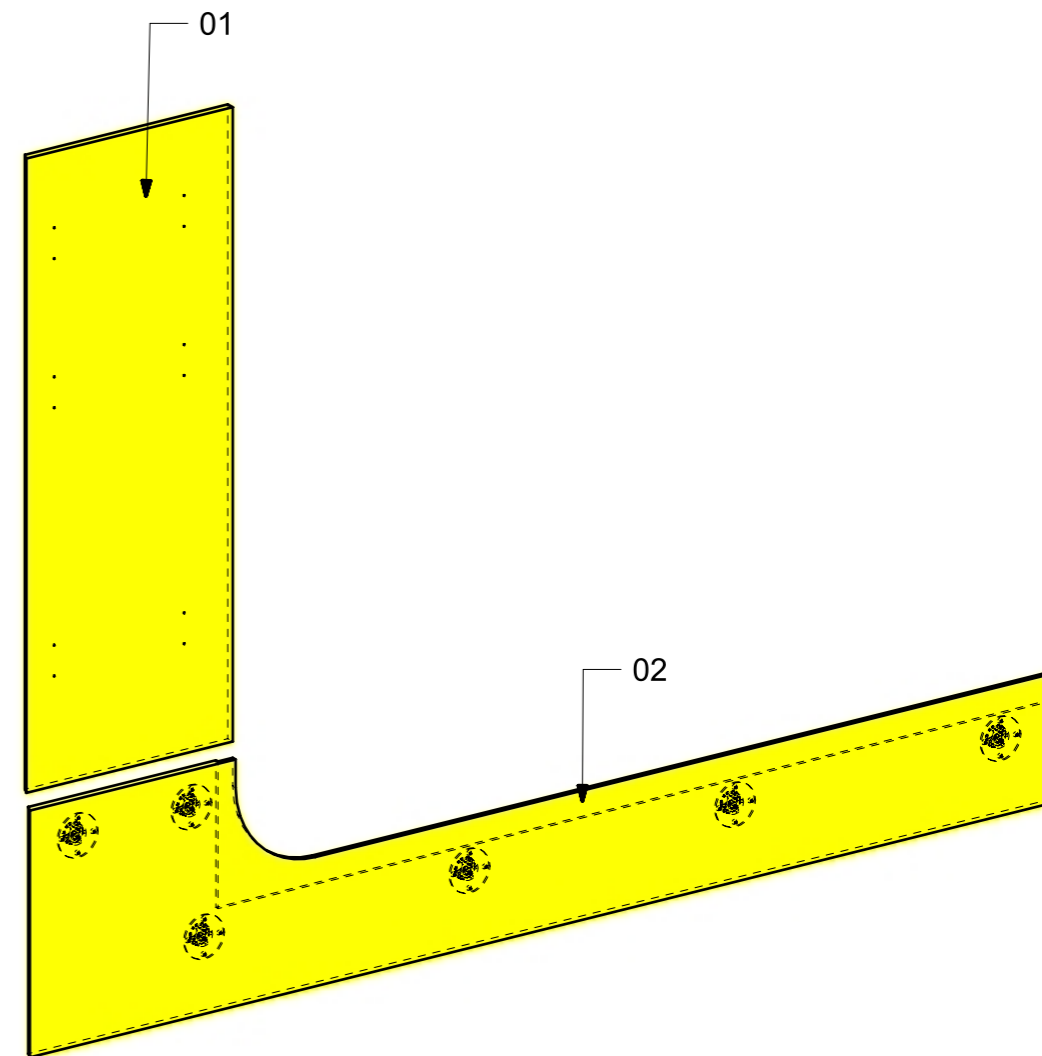

02

FERRAMENTA	QTY
FITLOCK M_MASCHERPA_3MM_6020202101	6

LOCALE	CODICE	DESCRIZIONE COMPONENTE	FINITURA	GR.
CABINA VIP	MD321_I01_VT01	MOBILE TV	OKUME' GREZZO	PTP

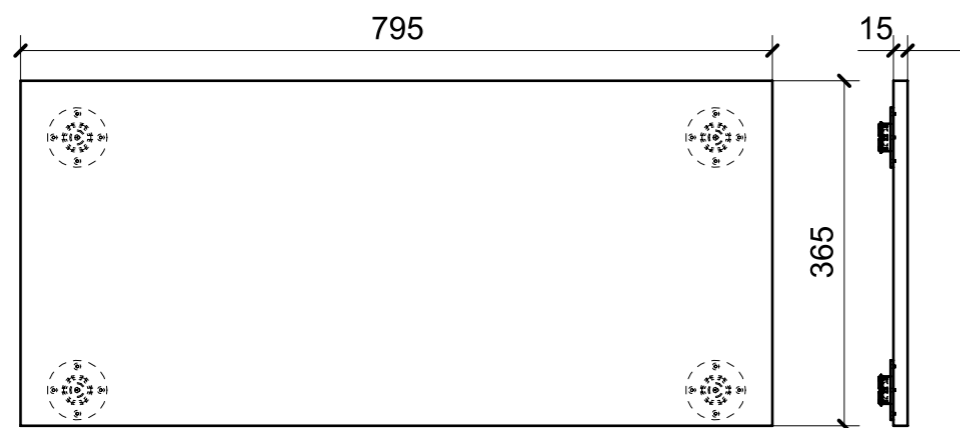

01

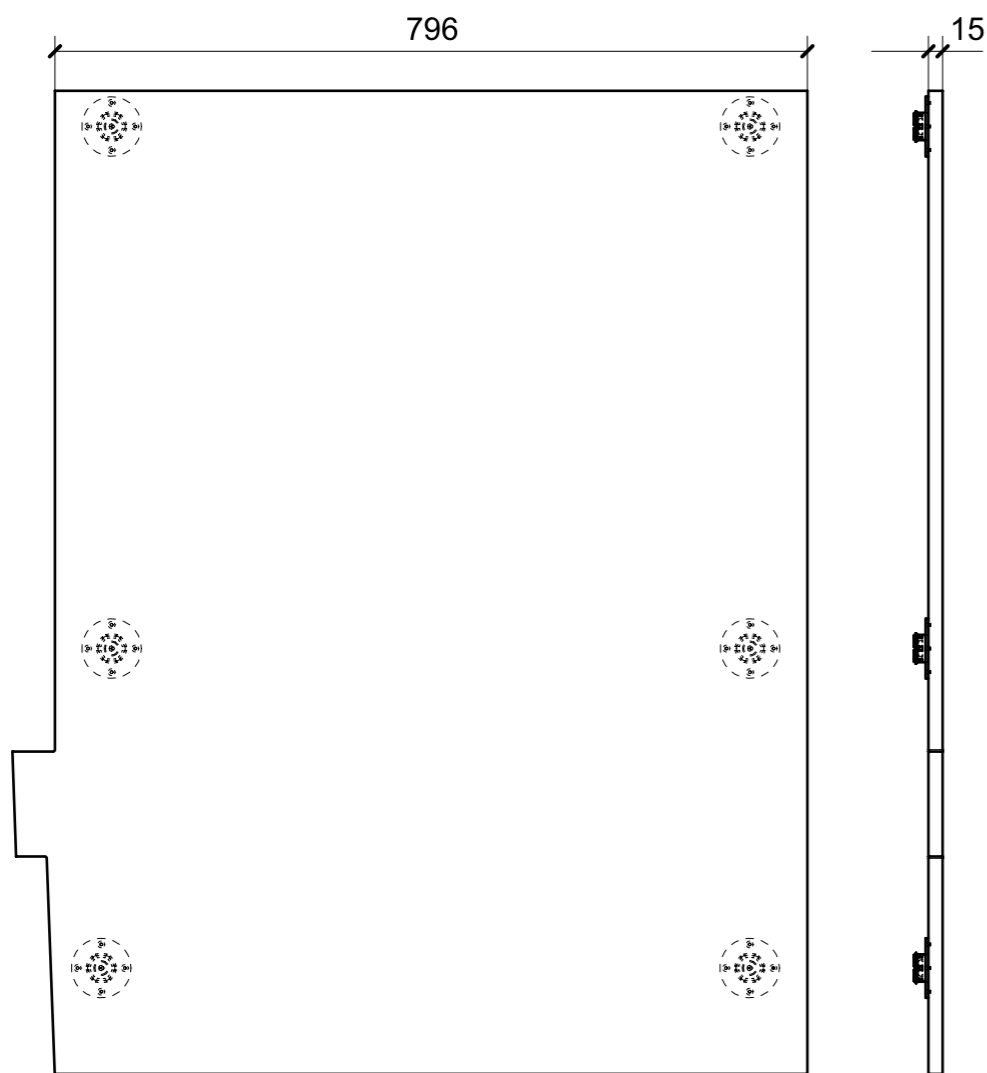
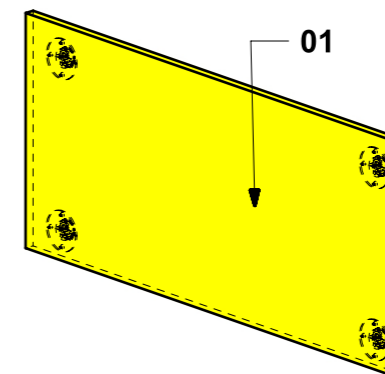

02

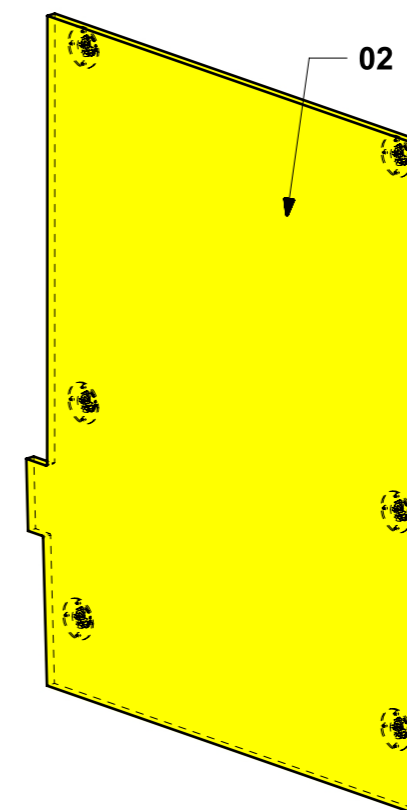

FERRAMENTA	QTY
FITLOCK M_MASCHERPA_3MM_6020202101	10

LOCALE	CODICE	DESCRIZIONE COMPONENTE	FINITURA	GR.
CABINA VIP	MD321_I01_VU01	CIELINI	OKUME' GREZZO	PTP

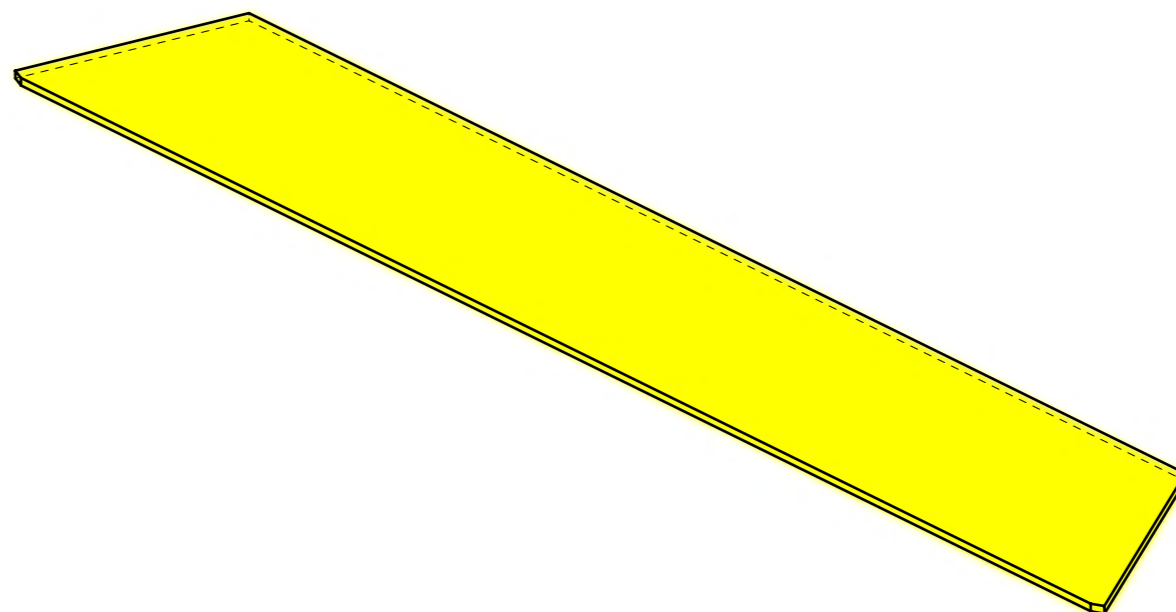
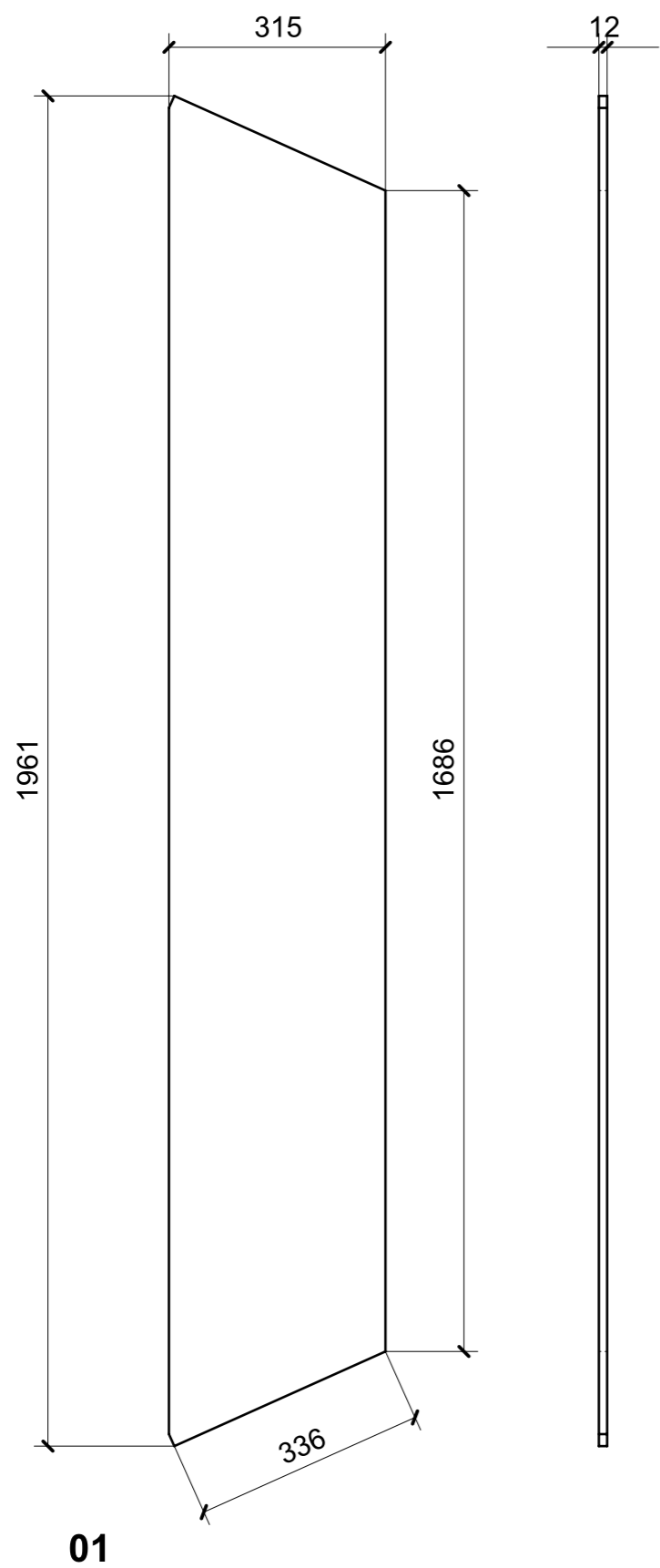

LOCALE	CODICE	DESCRIZIONE COMPONENTE	FINITURA	GR.
CABINA VIP	MD321_I01_VV01	RIVESTIMENTO PARATIA BAGNO	OKUME' GREZZO	PTP

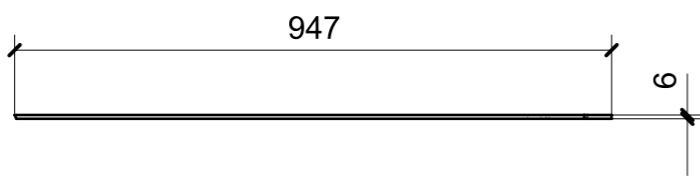
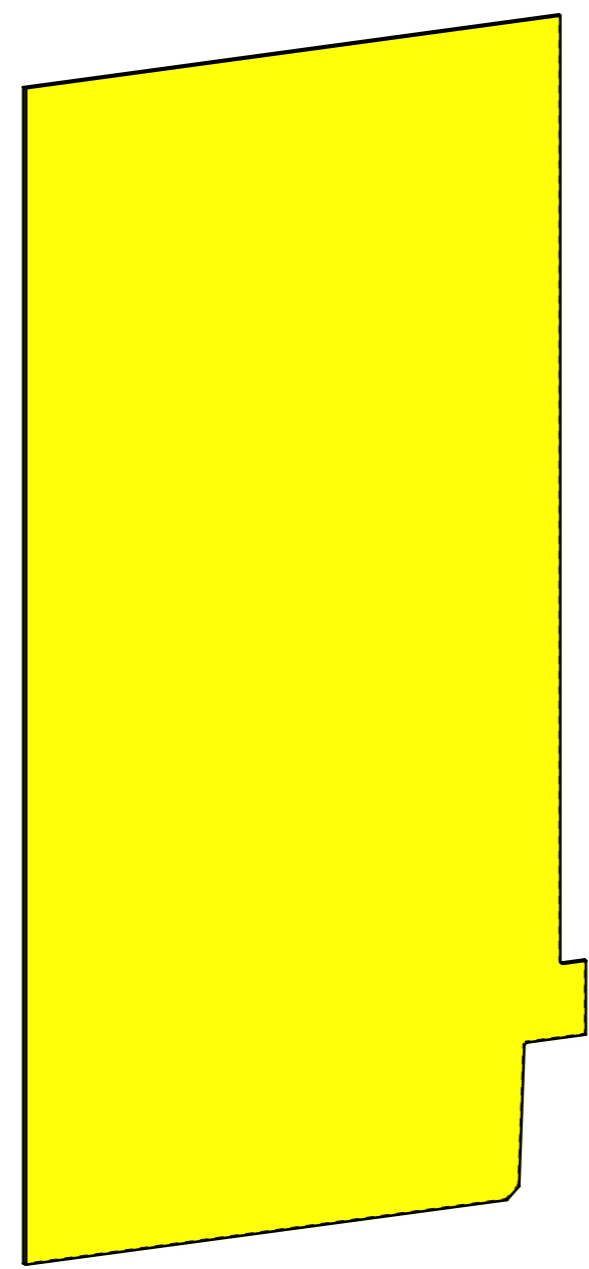
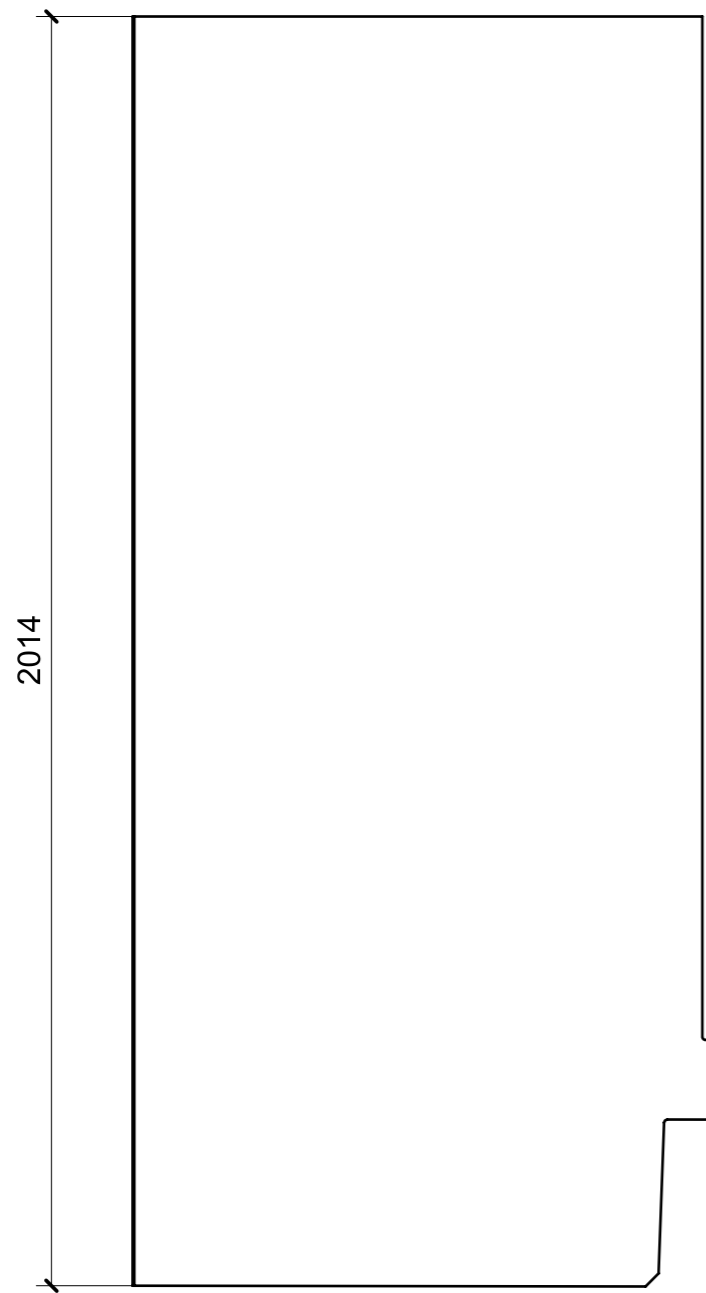

01