

| LOCALE        | CODICE          | DESCRIZIONE COMPONENTE         | FINITURA      | GR |
|---------------|-----------------|--------------------------------|---------------|----|
| CABINA VIP SX | MD320_R02_VVA01 | STRUTTURA MURATA TESTATA LETTO | LASTRA CHIARA | 4  |

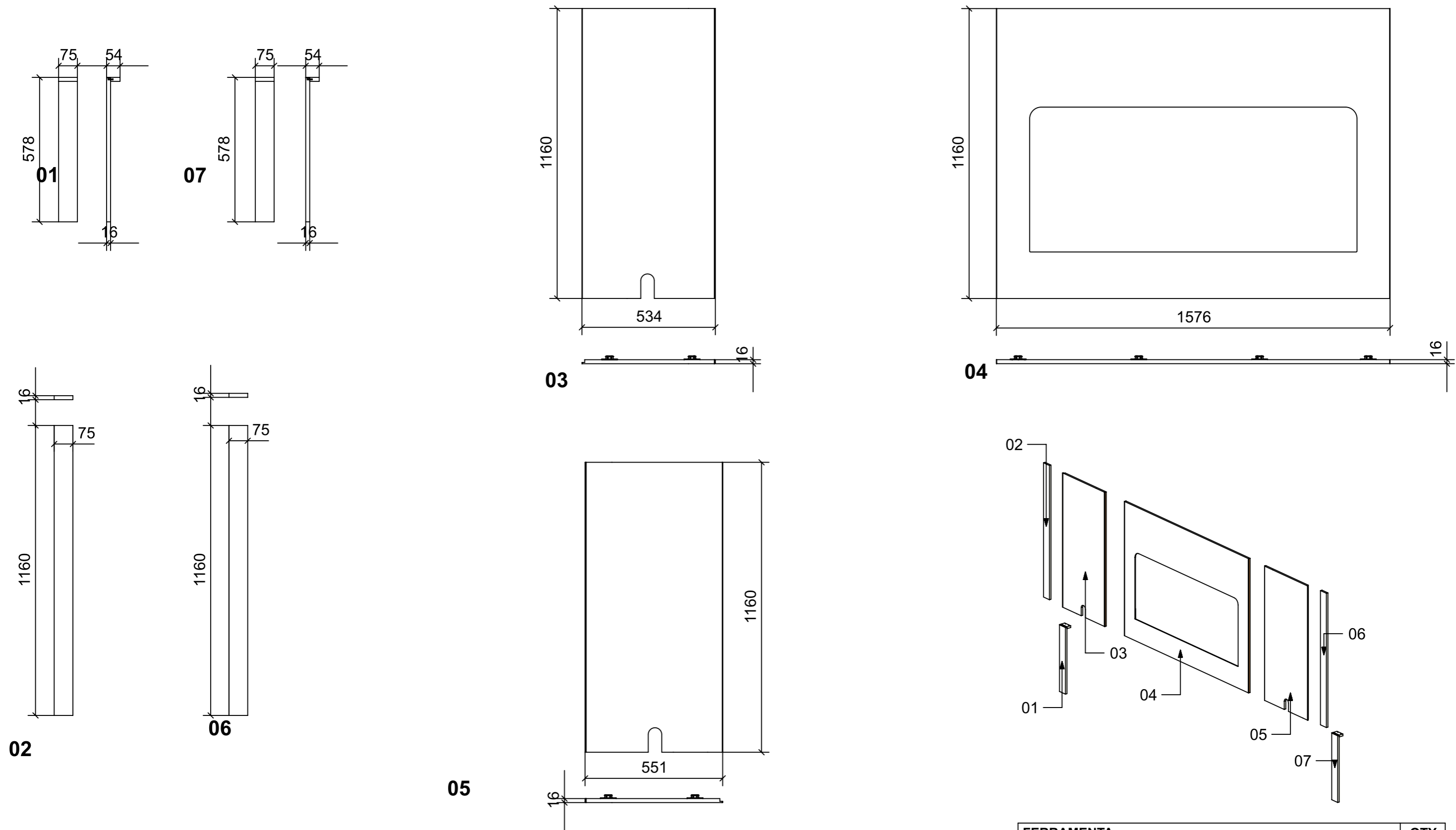

| FERRAMENTA                         | QTY |
|------------------------------------|-----|
| FITLOCK M_MASCHERPA_3MM_6020202101 | 20  |

VERNICIATURA LASTRA/LACCATI: ● = VERNICIARE 1 LATO + FILI RASATI O BORDATI    NESSUN SIMBOLO = VERNICIARE 2 LATI + FILI RASATI O BORDATI

| LOCALE        | CODICE          | DESCRIZIONE COMPONENTE   | FINITURA     | Q.TA |
|---------------|-----------------|--------------------------|--------------|------|
| CABINA VIP SX | MD320_R01_VVE01 | RIVESTIMENTI PARETI PRUA | LASTRA SCURA | 3    |

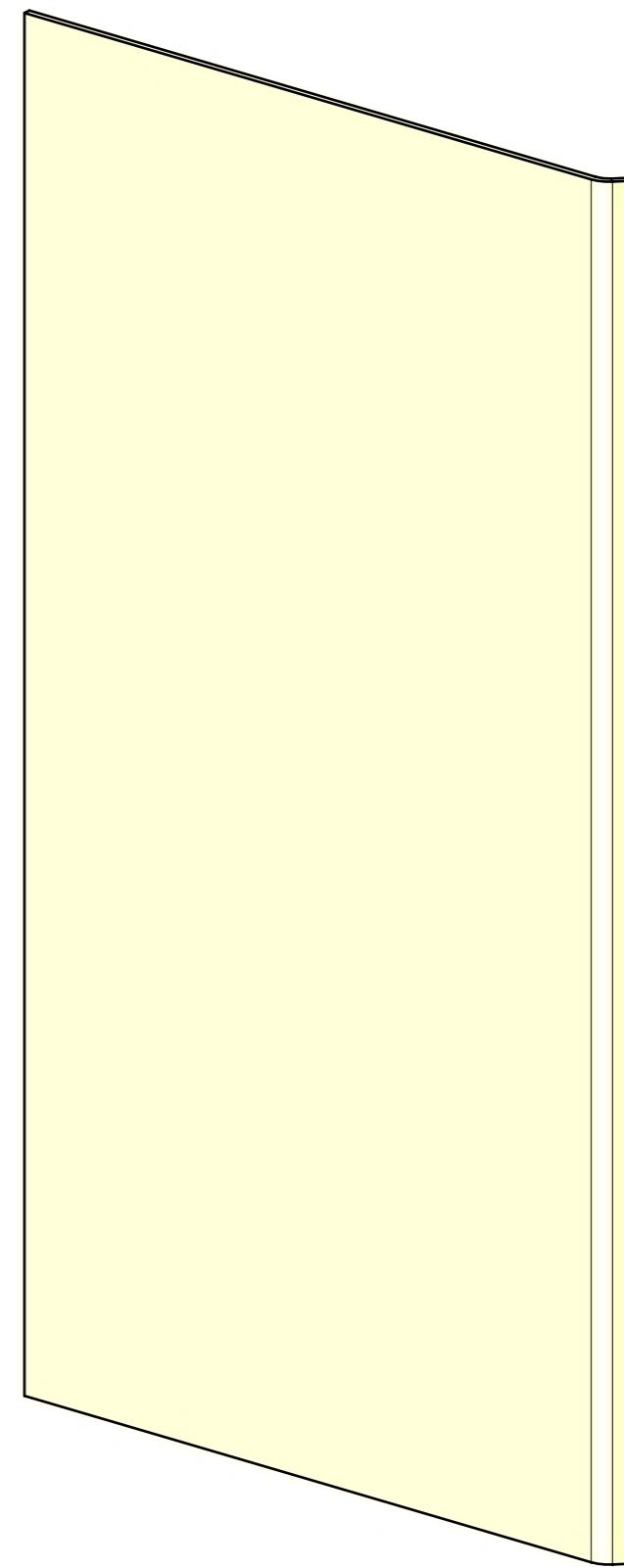
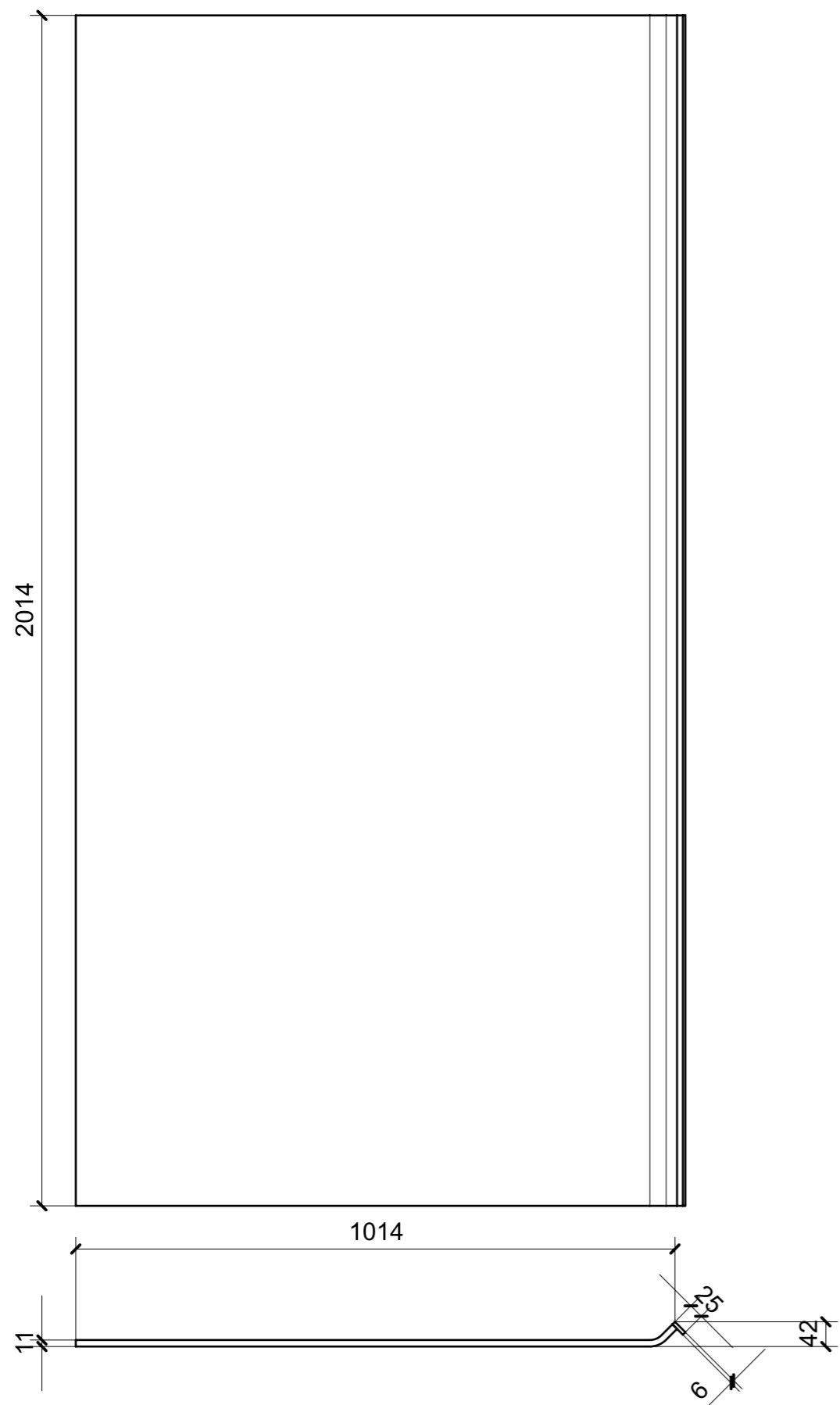

VERNICIATURA LASTRA/LACCATI:

● = VERNICIARE 1 LATO + FILI RASATI O BORDATI

NESSUN SIMBOLO = VERNICIARE 2 LATI + FILI RASATI O BORDATI

| LOCALE        | CODICE          | DESCRIZIONE COMPONENTE   | FINITURA      | Q.TA |
|---------------|-----------------|--------------------------|---------------|------|
| CABINA VIP SX | MD320_R02_VVE01 | RIVESTIMENTI PARETI PRUA | LASTRA CHIARA | 3    |

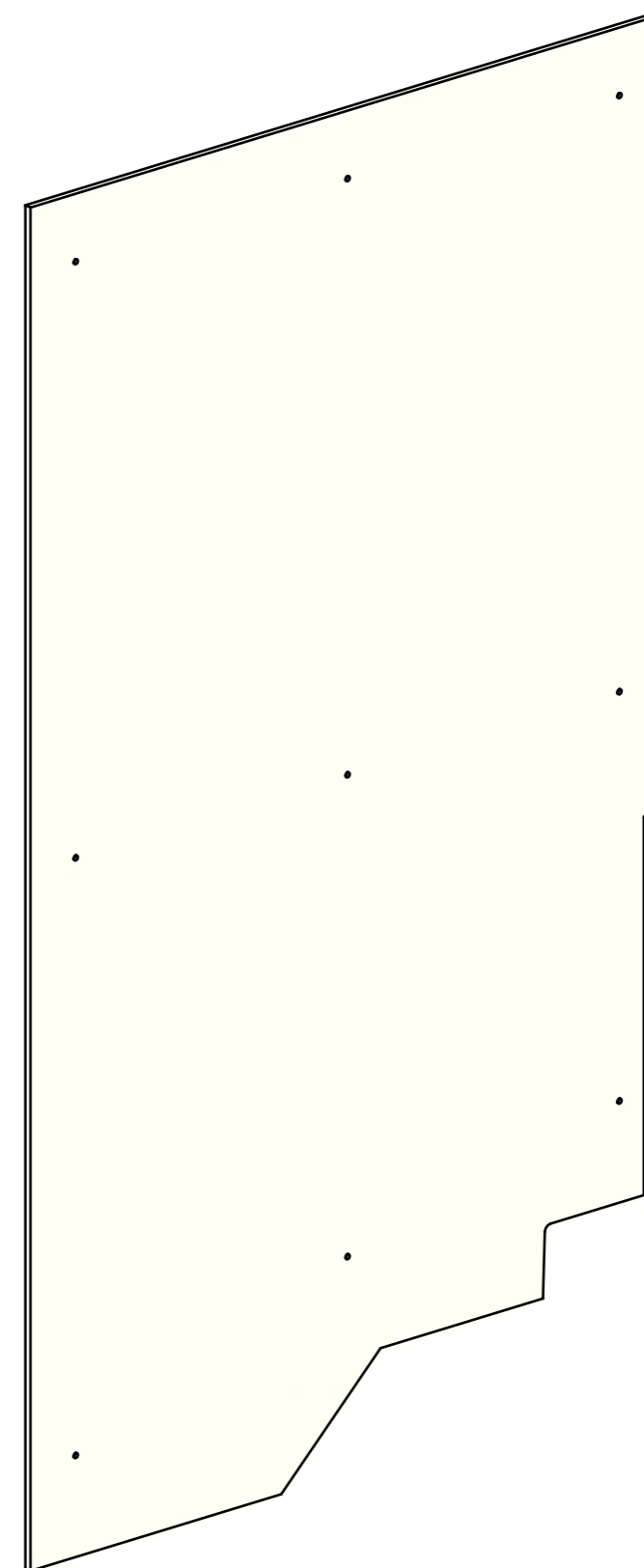
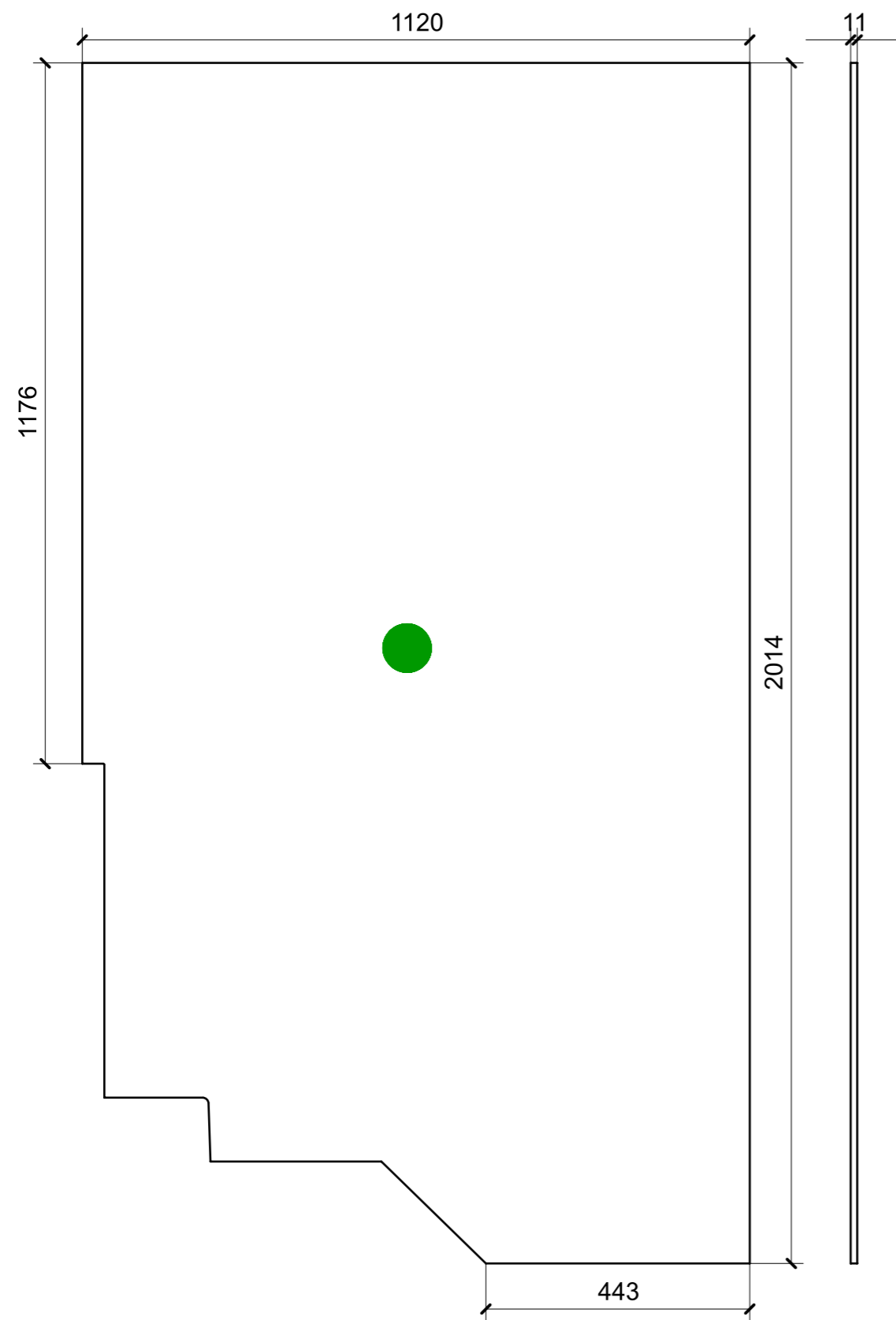

VERNICIATURA LASTRA/LACCATI:

● = VERNICIARE 1 LATO + FILI RASATI O BORDATI

NESSUN SIMBOLO = VERNICIARE 2 LATI + FILI RASATI O BORDATI

| LOCALE        | CODICE          | DESCRIZIONE COMPONENTE    | FINITURA     | GR |
|---------------|-----------------|---------------------------|--------------|----|
| CABINA VIP SX | MD320_R01_VVF01 | RIVESTIMENTI PARETI POPPA | LASTRA SCURA | 3  |

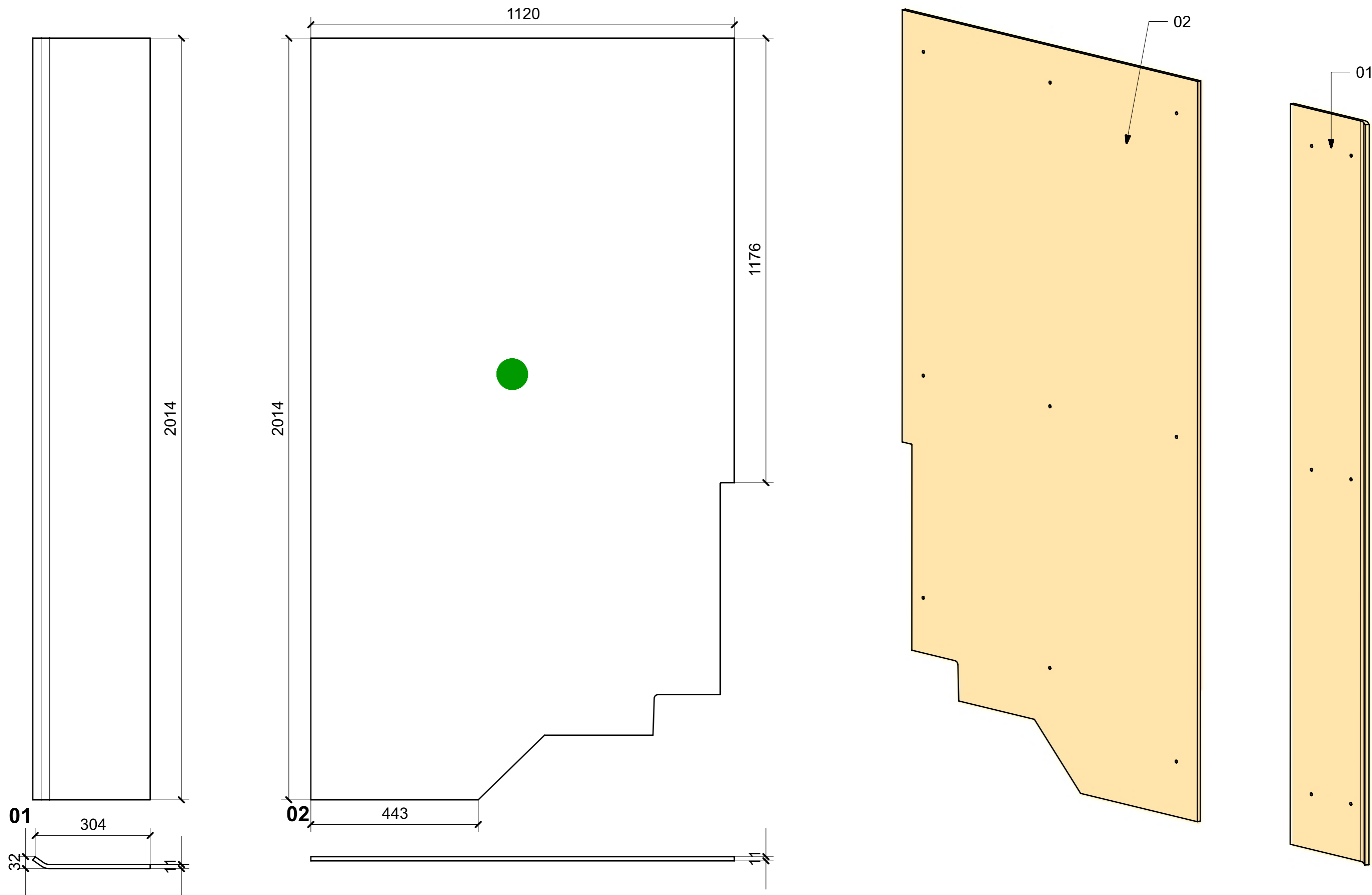

VERNICIATURA LASTRA/LACCATI: ● = VERNICIARE 1 LATO + FILI RASATI O BORDATI

NESSUN SIMBOLO = VERNICIARE 2 LATI + FILI RASATI O BORDATI

| LOCALE        | CODICE          | DESCRIZIONE COMPONENTE    | FINITURA      | GR |
|---------------|-----------------|---------------------------|---------------|----|
| CABINA VIP SX | MD320_R02_VVF01 | RIVESTIMENTI PARETI POPPA | LASTRA CHIARA | 3  |

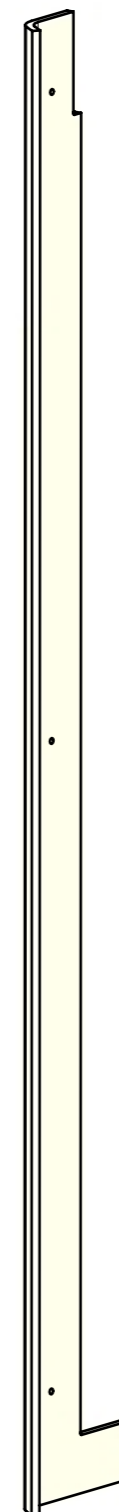
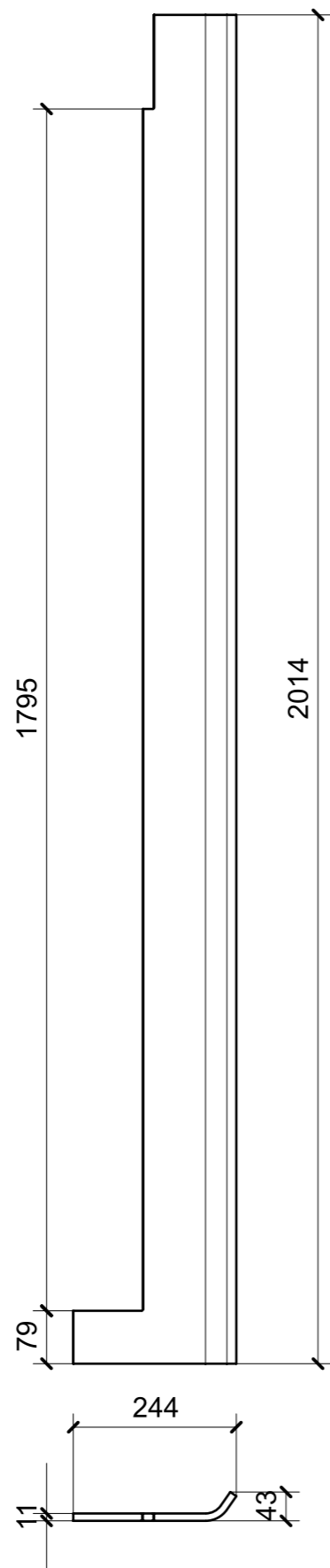

VERNICIATURA LASTRA/LACCATI: ● = VERNICIARE 1 LATO + FILI RASATI O BORDATI

NESSUN SIMBOLO = VERNICIARE 2 LATI + FILI RASATI O BORDATI

| LOCALE        | CODICE          | DESCRIZIONE COMPONENTE          | FINITURA      | GR |
|---------------|-----------------|---------------------------------|---------------|----|
| CABINA VIP SX | MD320_R02_VVG01 | RIVESTIMENTI PARETI CENTRO NAVE | LASTRA CHIARA | 3  |

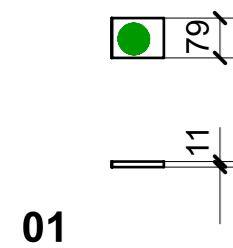
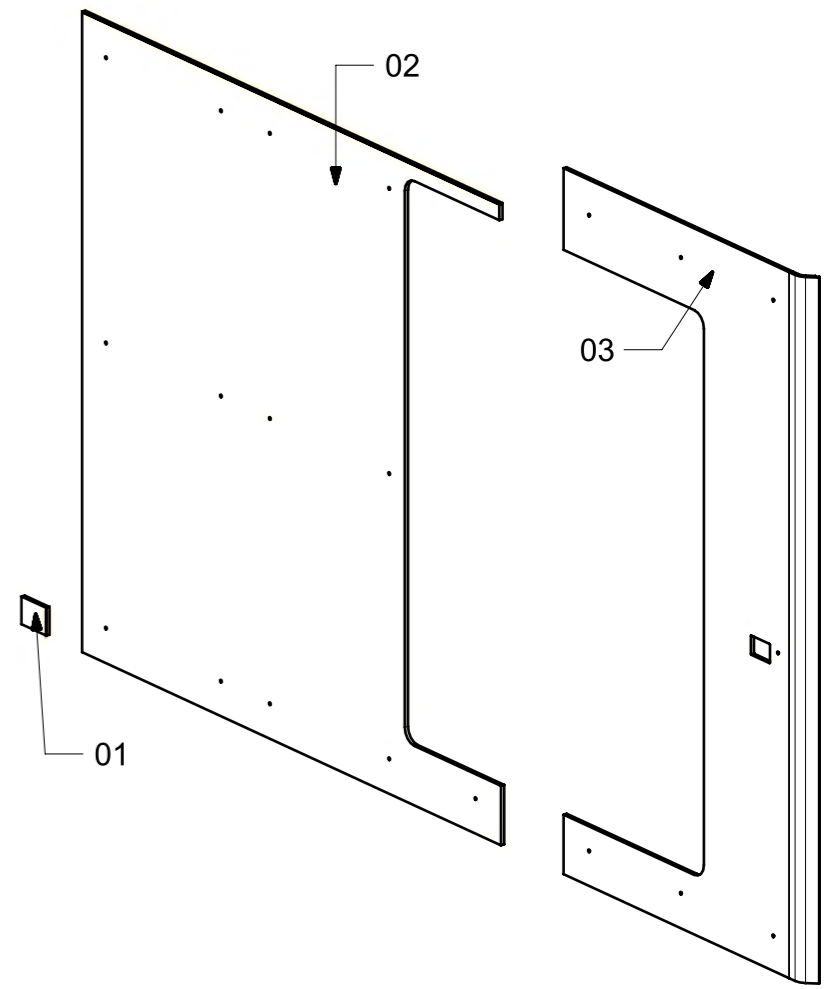
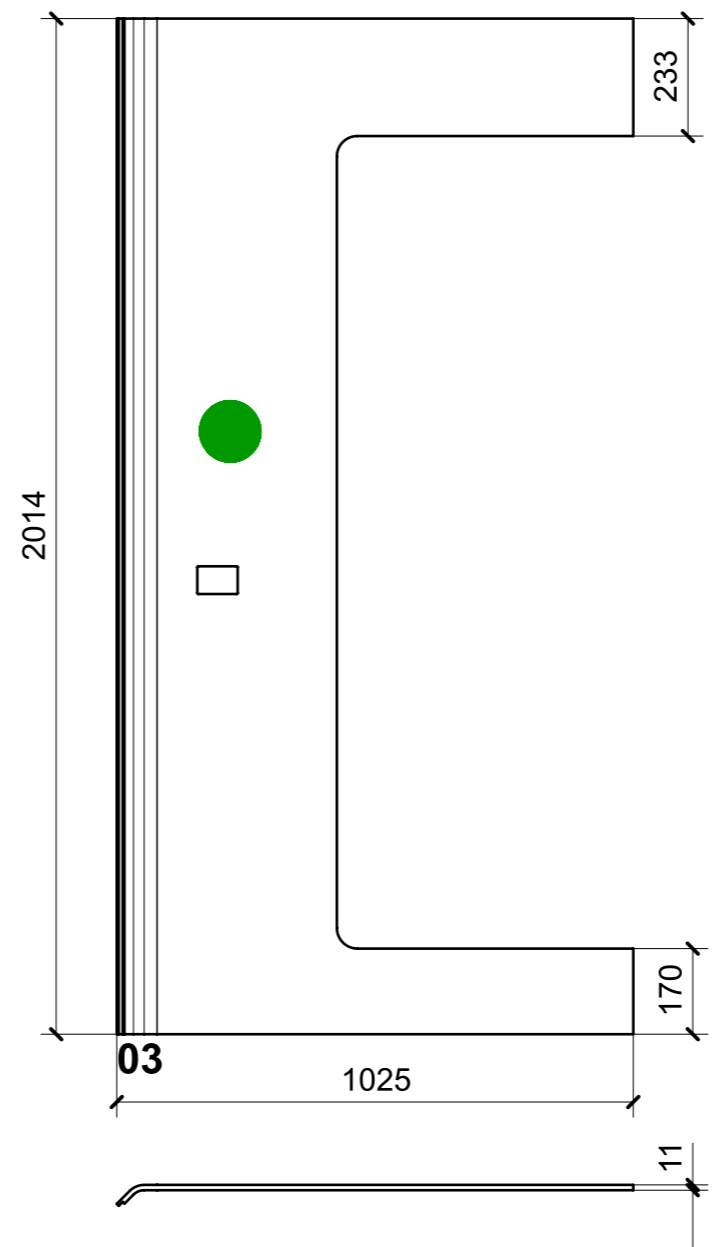
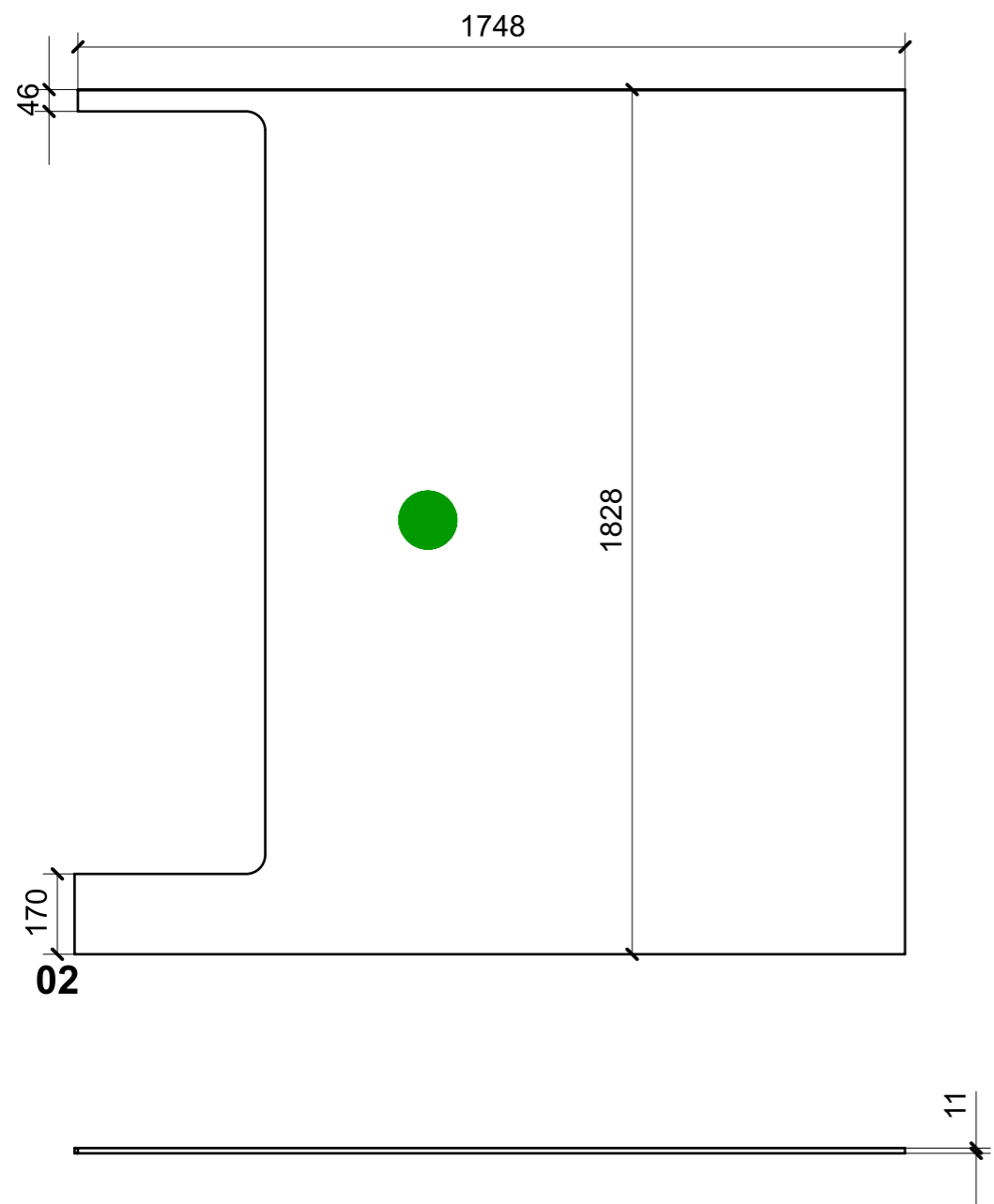

VERNICIATURA LASTRA/LACCATI:

● = VERNICIARE 1 LATO + FILI RASATI O BORDATI

NESSUN SIMBOLO = VERNICIARE 2 LATI + FILI RASATI O BORDATI