

LOCALE	CODICE	DESCRIZIONE COMPONENTE	FINITURA	GR.
LOBBY LD	MD320_R01_CF01	RIVESTIMENTI PRUA SX	LASTRA SCURA	3

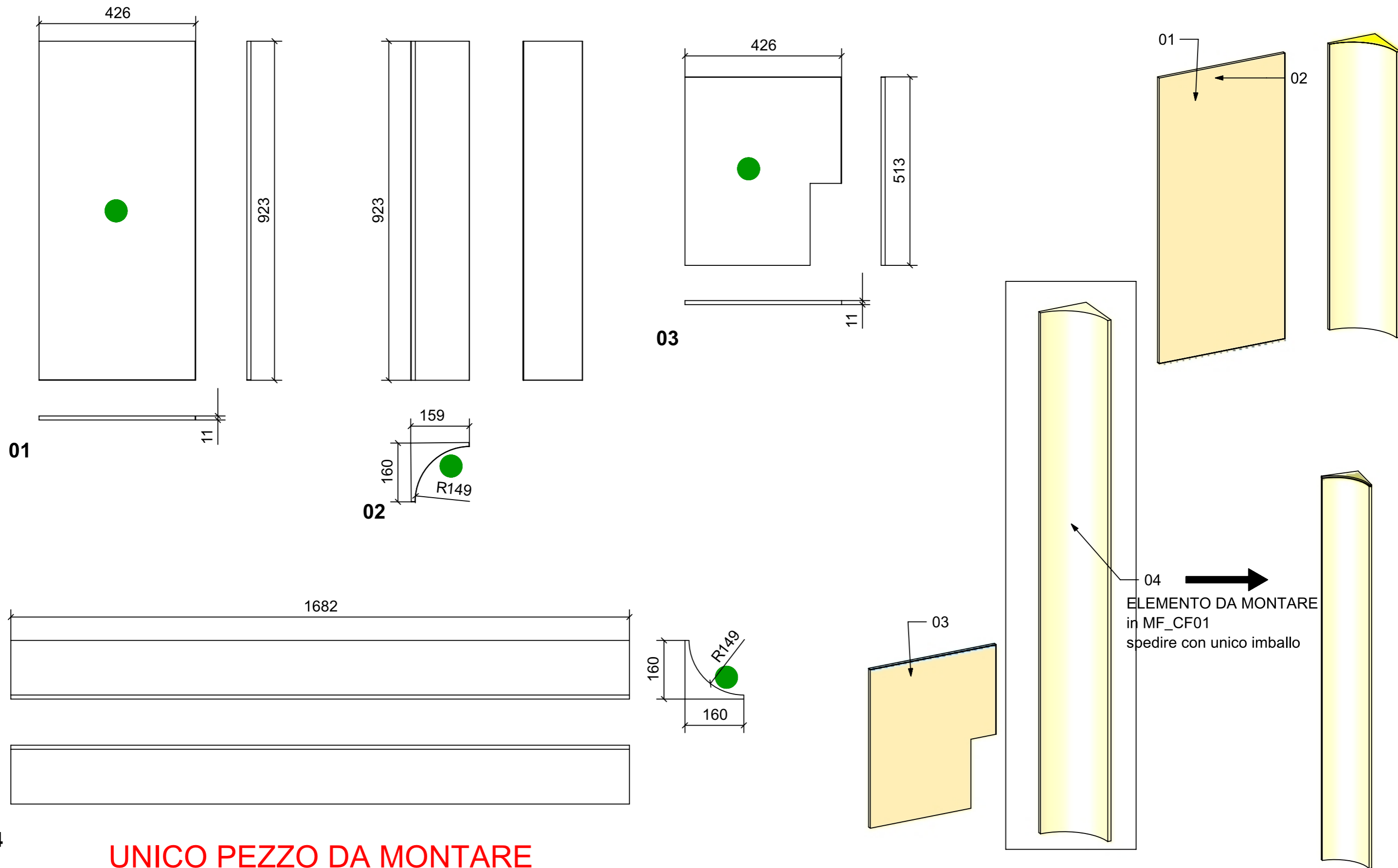

04

UNICO PEZZO DA MONTARE

VERNICIATURA LASTRA/LACCATI:

● = VERNICIARE 1 LATO + FILI RASATI O BORDATI

NESSUN SIMBOLO = VERNICIARE 2 LATI + FILI RASATI O BORDATI

LOCALE	CODICE	DESCRIZIONE COMPONENTE	FINITURA	GR.
LOBBY LD	MD320_R02_CG01	RIVESTIMENTI TRAVERSONAVE DISCESA SCALE PRUA	LASTRA CHIARA	2

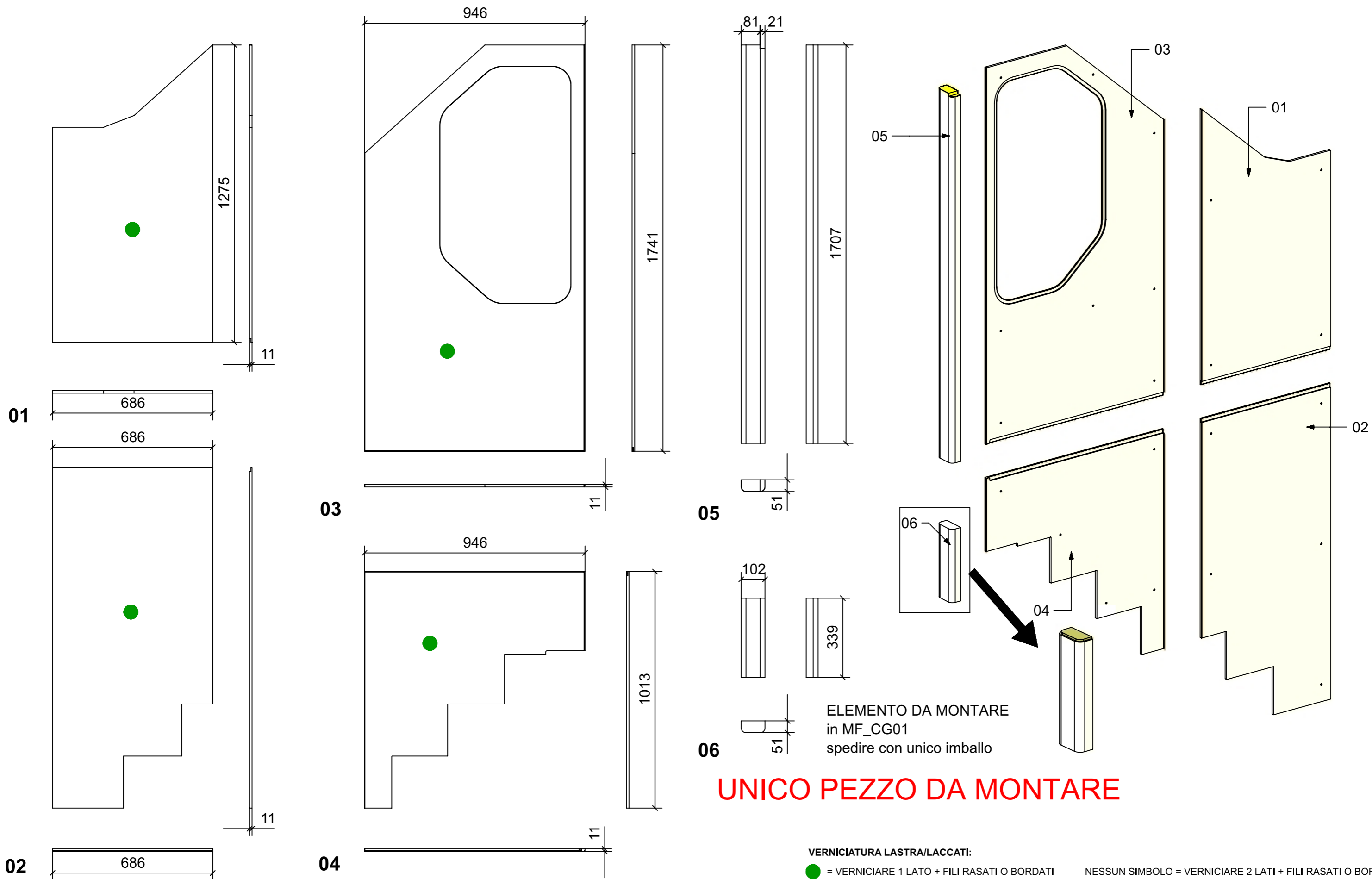

LOCALE	CODICE	DESCRIZIONE COMPONENTE	FINITURA	GR.
LOBBY LD	MD320_R01_CH01	MOBILE QUADRO ELETTRICO	LASTRA SCURA	4

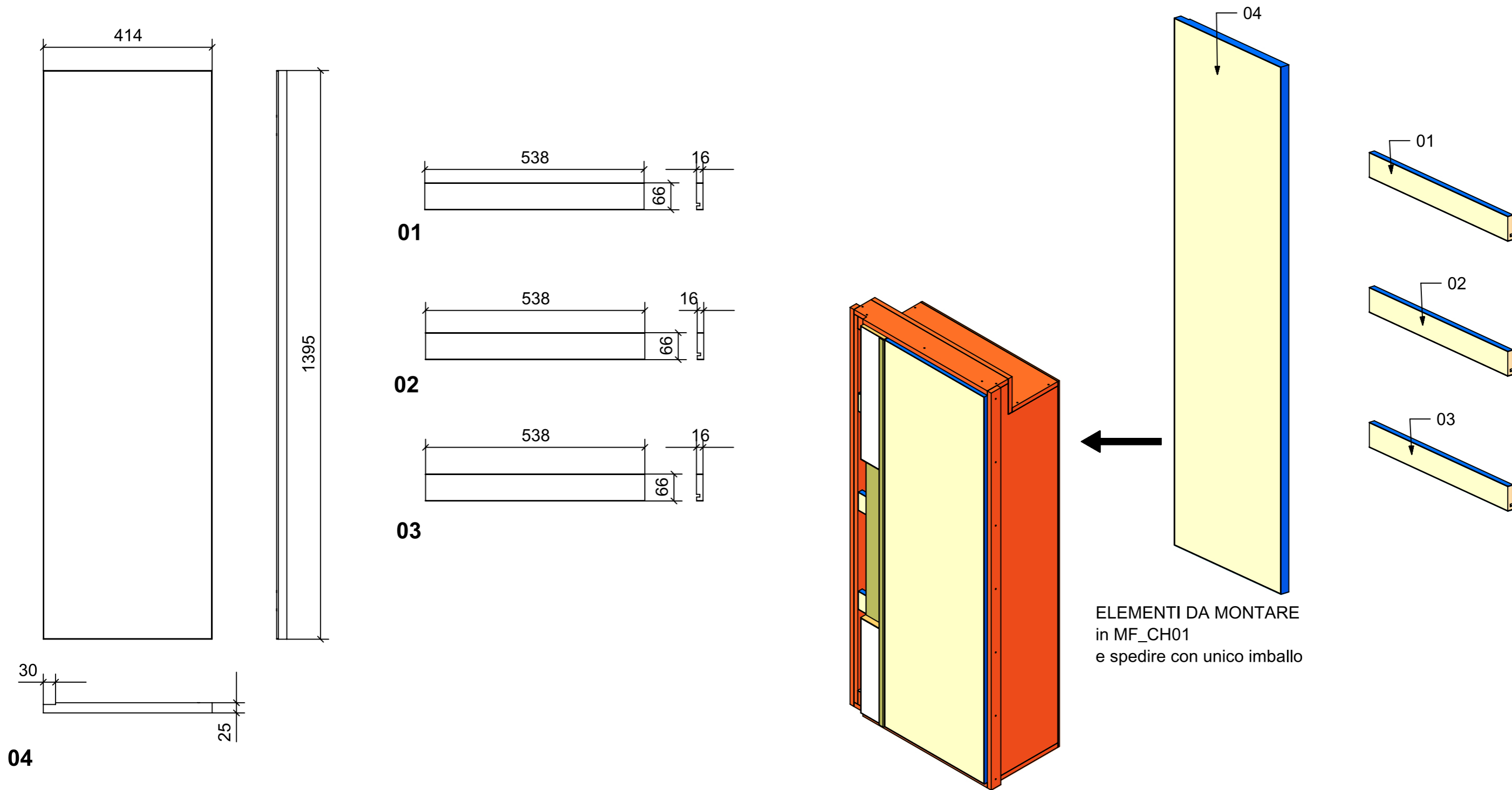

FERRAMENTA	QTY
BUSSOLA 5MAANKOR BORGHI X CERNIERA PIANA	6

VERNICIATURA LASTRA/LACCATI:

● = VERNICIARE 1 LATO + FILI RASATI O BORDATI

NESSUN SIMBOLO = VERNICIARE 2 LATI + FILI RASATI O BORDATI

LOCALE	CODICE	DESCRIZIONE COMPONENTE	FINITURA	GR.
LOBBY LD	MD320_R02_CH01	MOBILE QUADRO ELETTRICO	LASTRA CHIARA	4

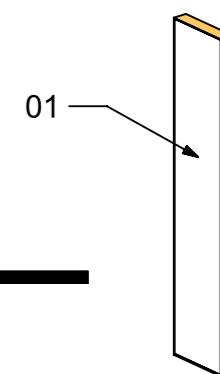
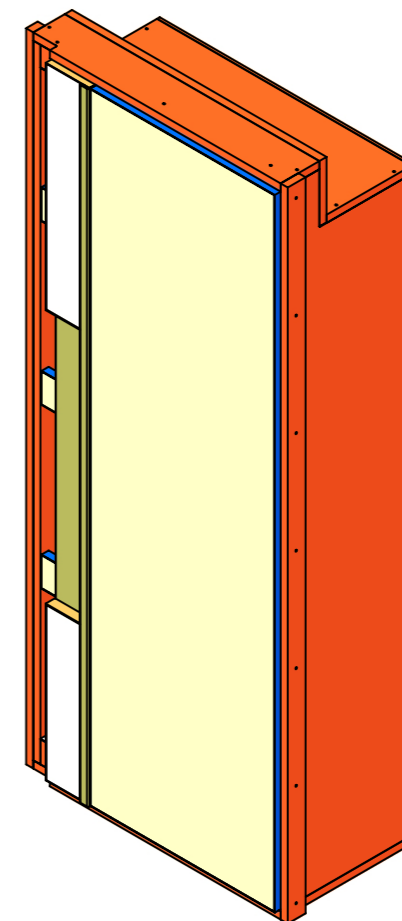
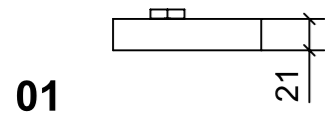
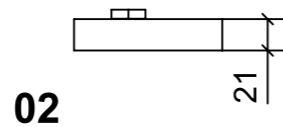
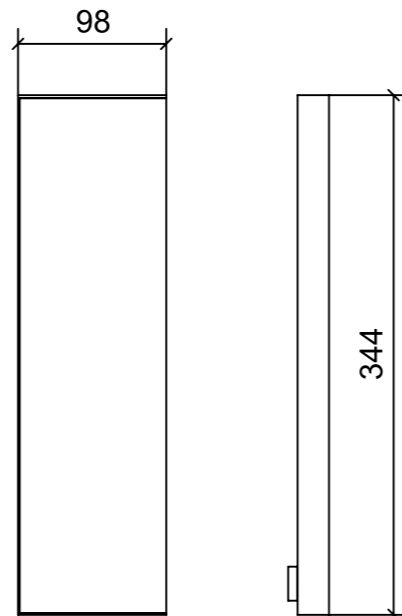
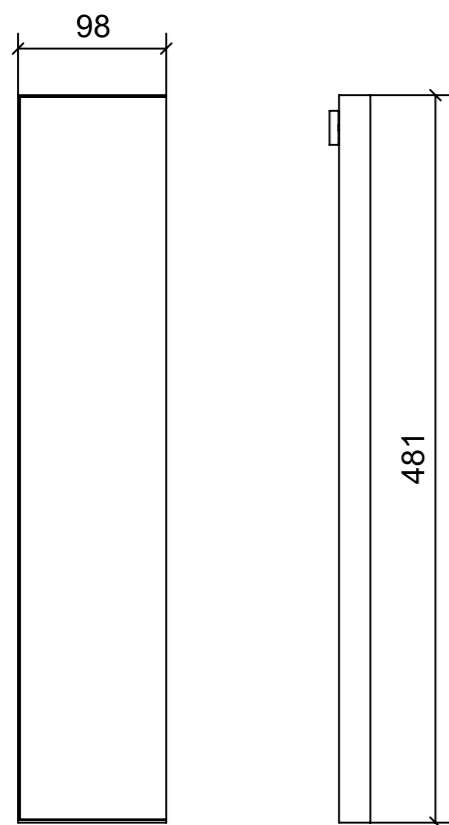

ELEMENTI DA MONTARE
in MF_CH01
e spedire con unico imballo

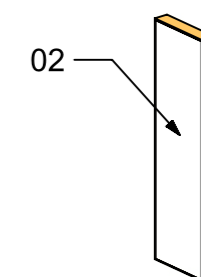

FERRAMENTA	QTY
MAGNETE FORZA MAGNETICA1-5 10KG_HAFELE_246.87.112	2

VERNICIATURA LASTRA/LACCATI:

● = VERNICIARE 1 LATO + FILI RASATI O BORDATI

NESSUN SIMBOLO = VERNICIARE 2 LATI + FILI RASATI O BORDATI