

LOCALE	CODICE	DESCRIZIONE COMPONENTE	FINITURA	GR.
CABINA OSPITI SX	MD320_R01_LA01	ARMADIO	LASTRA SCURA	4

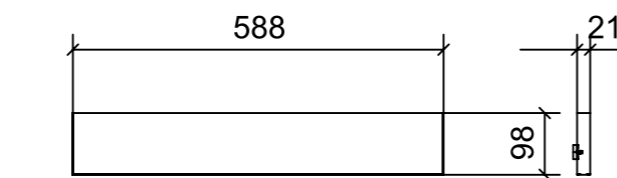

04

05

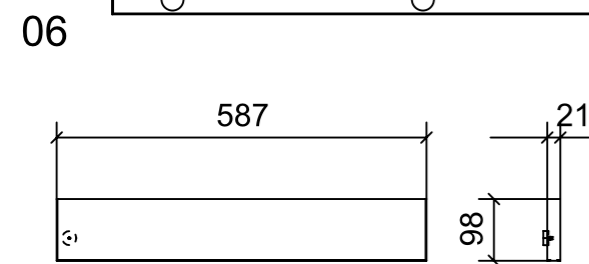
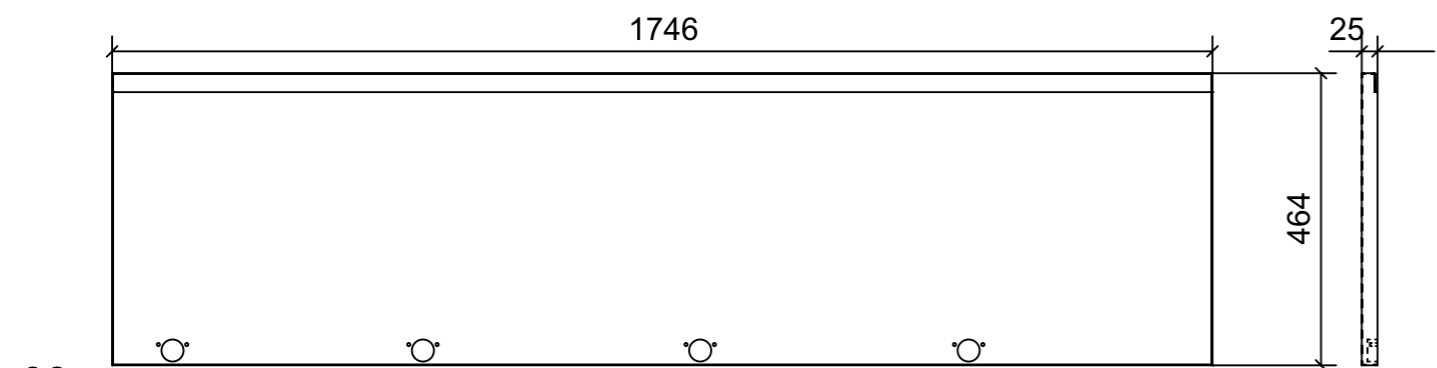
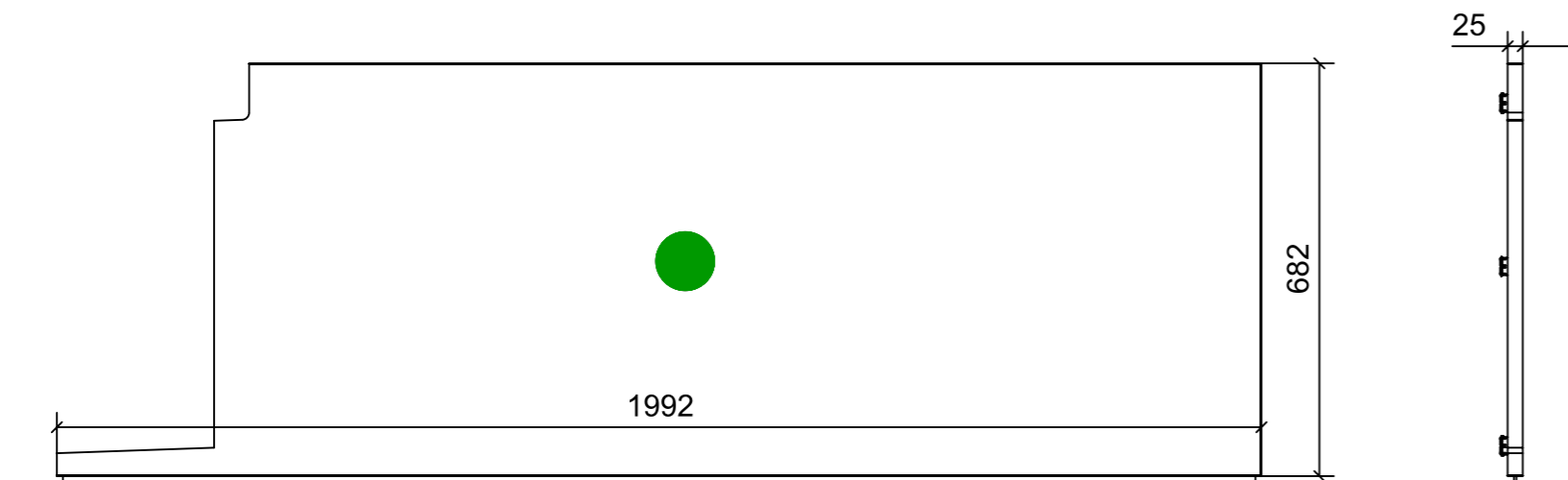

01

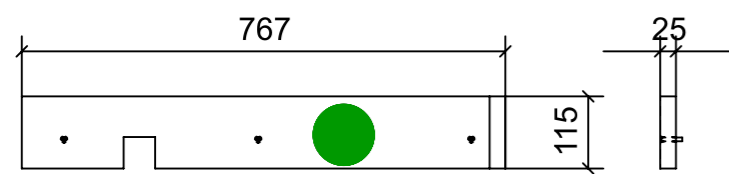

02

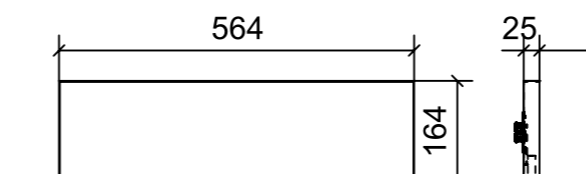

07

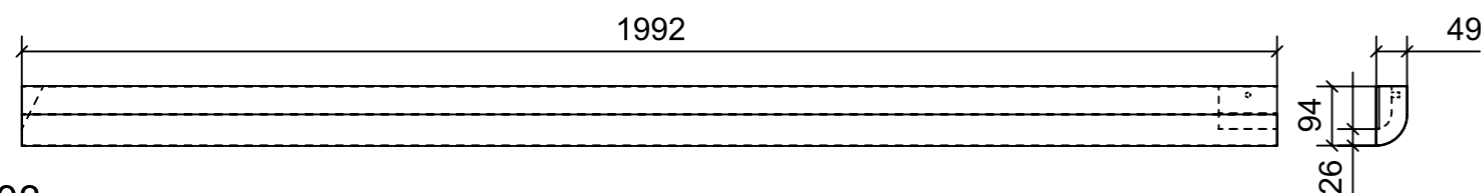

03

ELEMENTI DA MONTARE  
in MA\_LA01  
e spedire con unico imballo

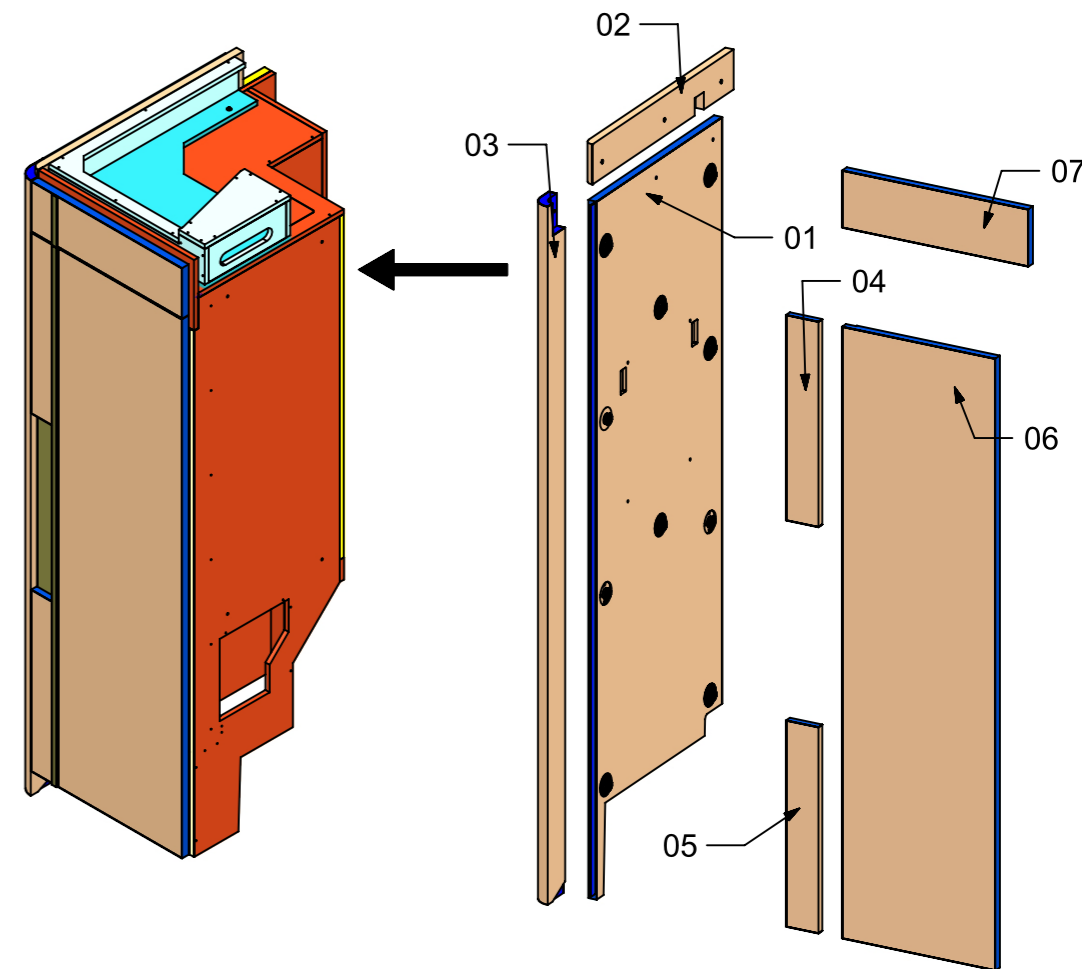

FERRAMENTA	QTY
FITLOCK M_MASCHERPA_3MM_6020202101	12
MAGNETE FORZA MAGNETICA1-5 10KG_HAFELE_246.87.112	2
VITE 6MA X 35 TESTA SVASATA	3

VERNICIATURA LASTRA/LACCATI:

● = VERNICIARE 1 LATO + FILI RASATI O BORDATI

NESSUN SIMBOLO = VERNICIARE 2 LATI + FILI RASATI O BORDATI

LOCALE	CODICE	DESCRIZIONE COMPONENTE	FINITURA	GR.
CABINA OSPITI SX	MD320_R01_LC01	STRUTTURA MURATA	LASTRA SCURA	4

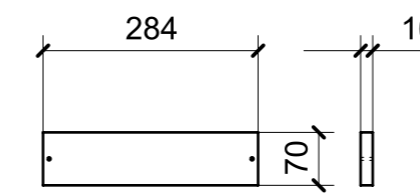
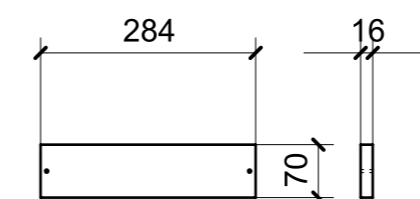
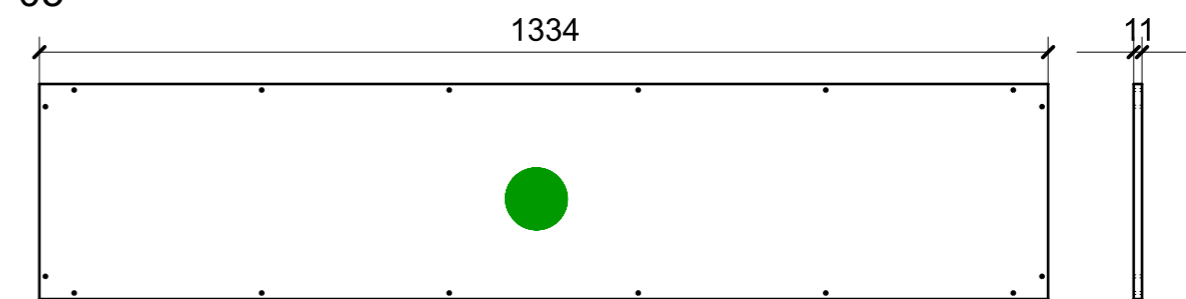
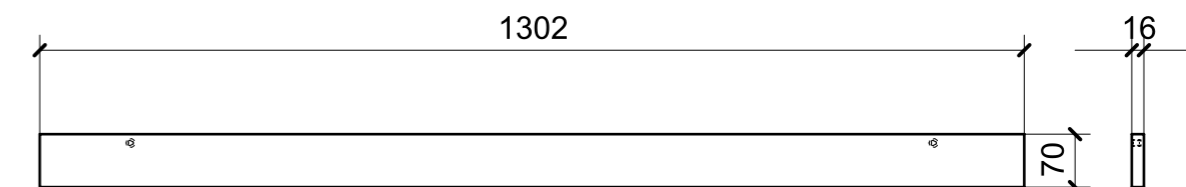
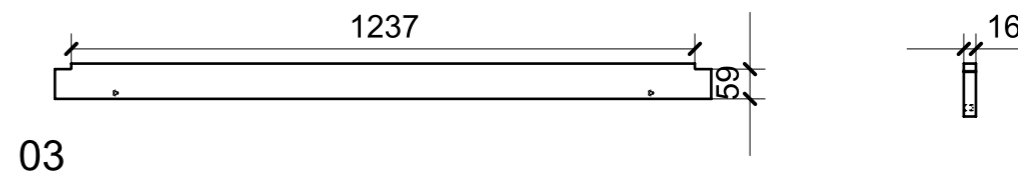
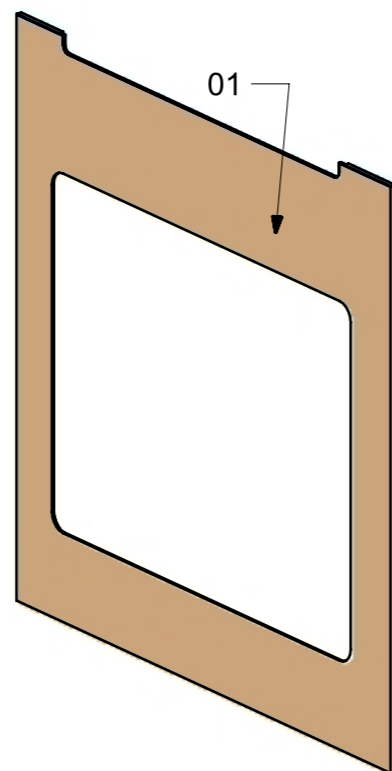
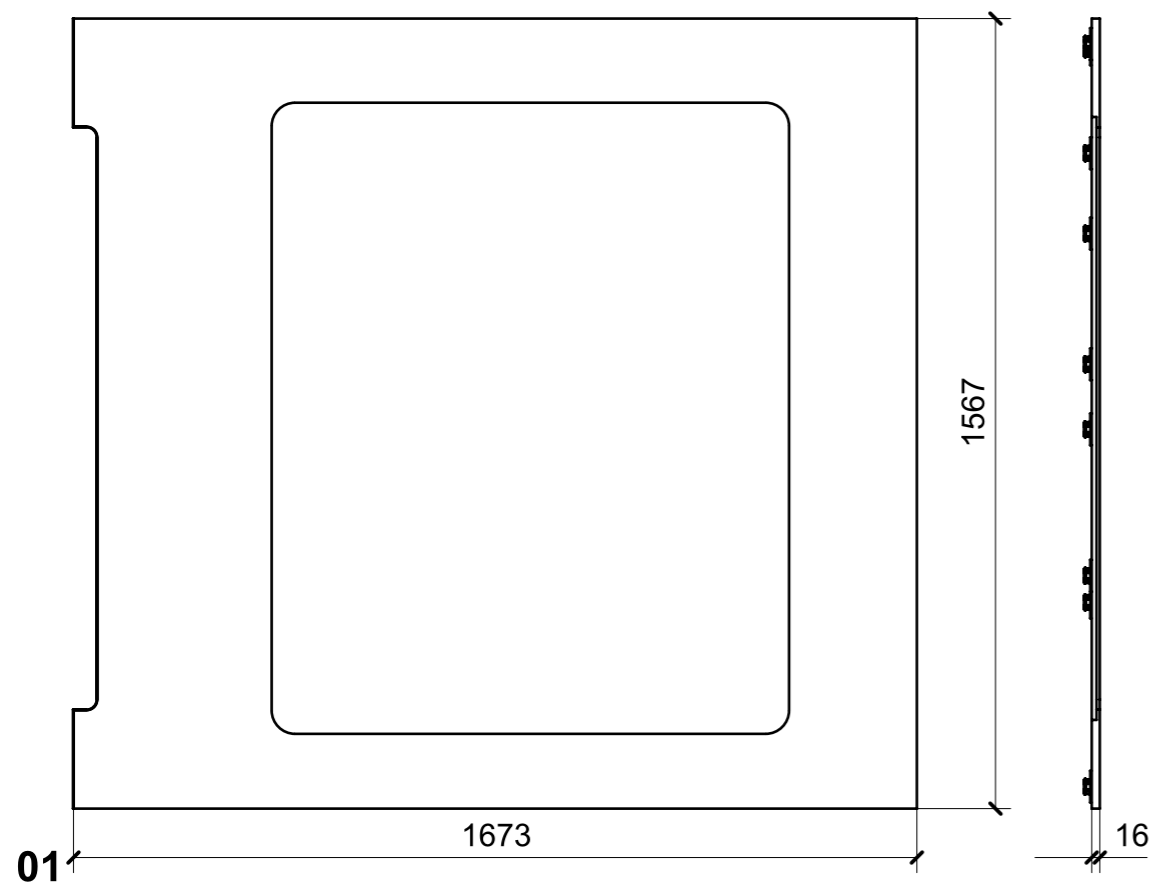

02

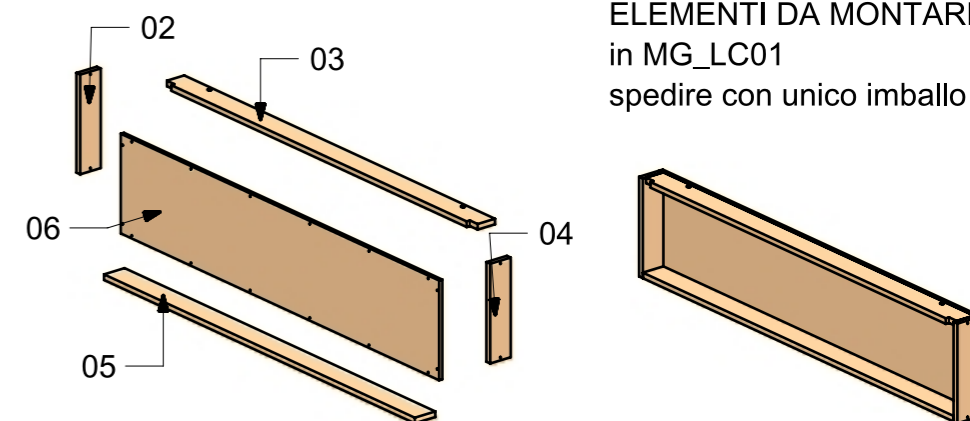

ELEMENTI DA MONTARE  
in MG\_LC01  
spedire con unico imballo

FERRAMENTA	QTY
BUSSOLA 6MA X 10 FORO DIAM.8	4
FITLOCK M_MASCHERPA_3MM_6020202101	17

VERNICIATURA LASTRA/LACCATI:

● = VERNICIARE 1 LATO + FILI RASATI O BORDATI

NESSUN SIMBOLO = VERNICIARE 2 LATI + FILI RASATI O BORDATI

LOCALE	CODICE	DESCRIZIONE COMPONENTE	FINITURA	GR.
CABINA OSPITI SX	MD320_R02_LP01	LETTO PULLMAN OPT	LAISTRA CHIARA	4

