

LOCALE	CODICE	DESCRIZIONE COMPONENTE	FINITURA	GR.
CABINA OSPITI DX	MD320_R01_RI01	ARMADIO	LASTRA SCURA	4

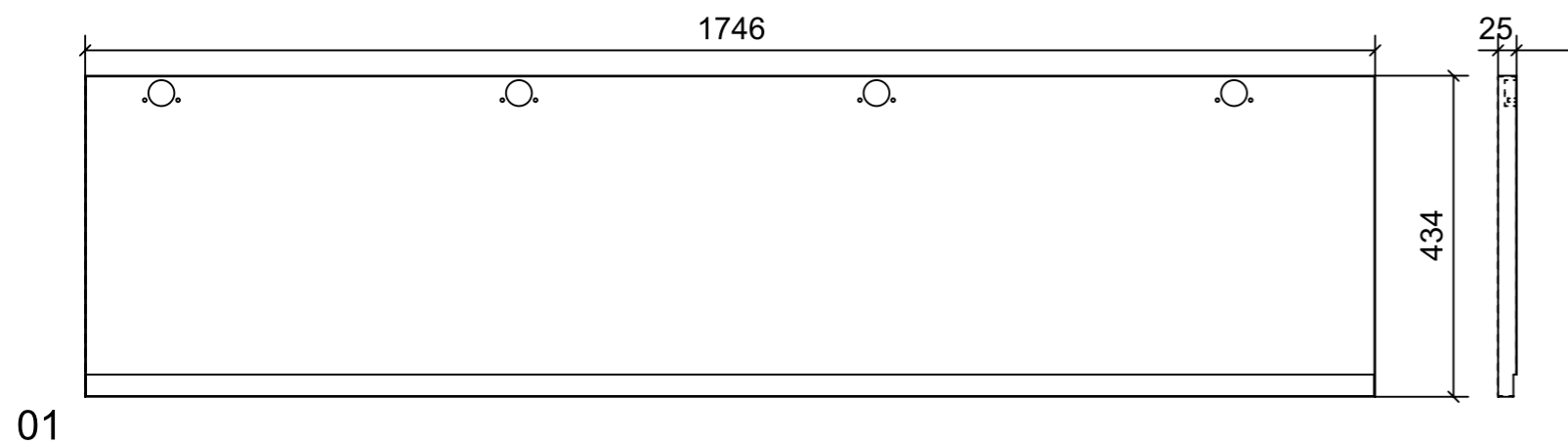

01

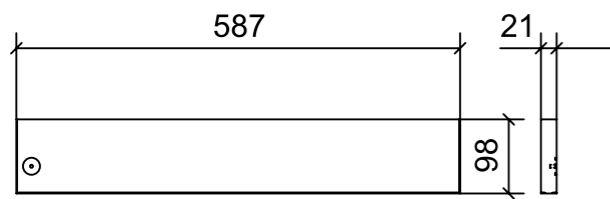

02

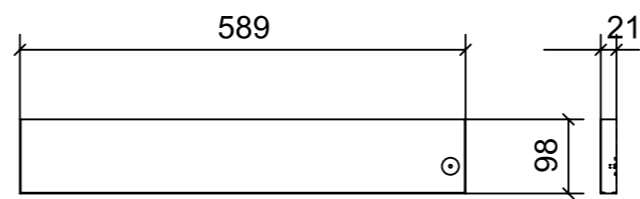

03

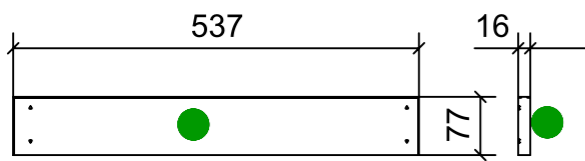

04

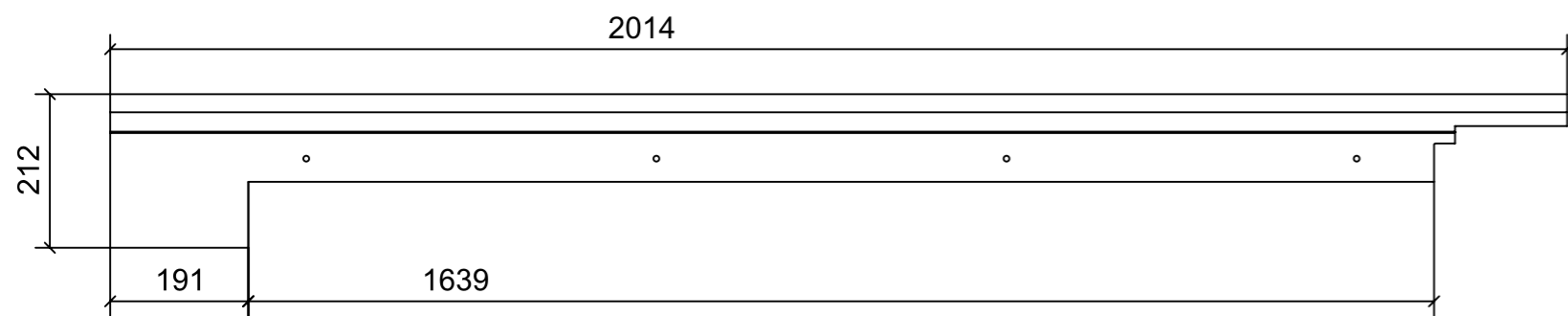

05

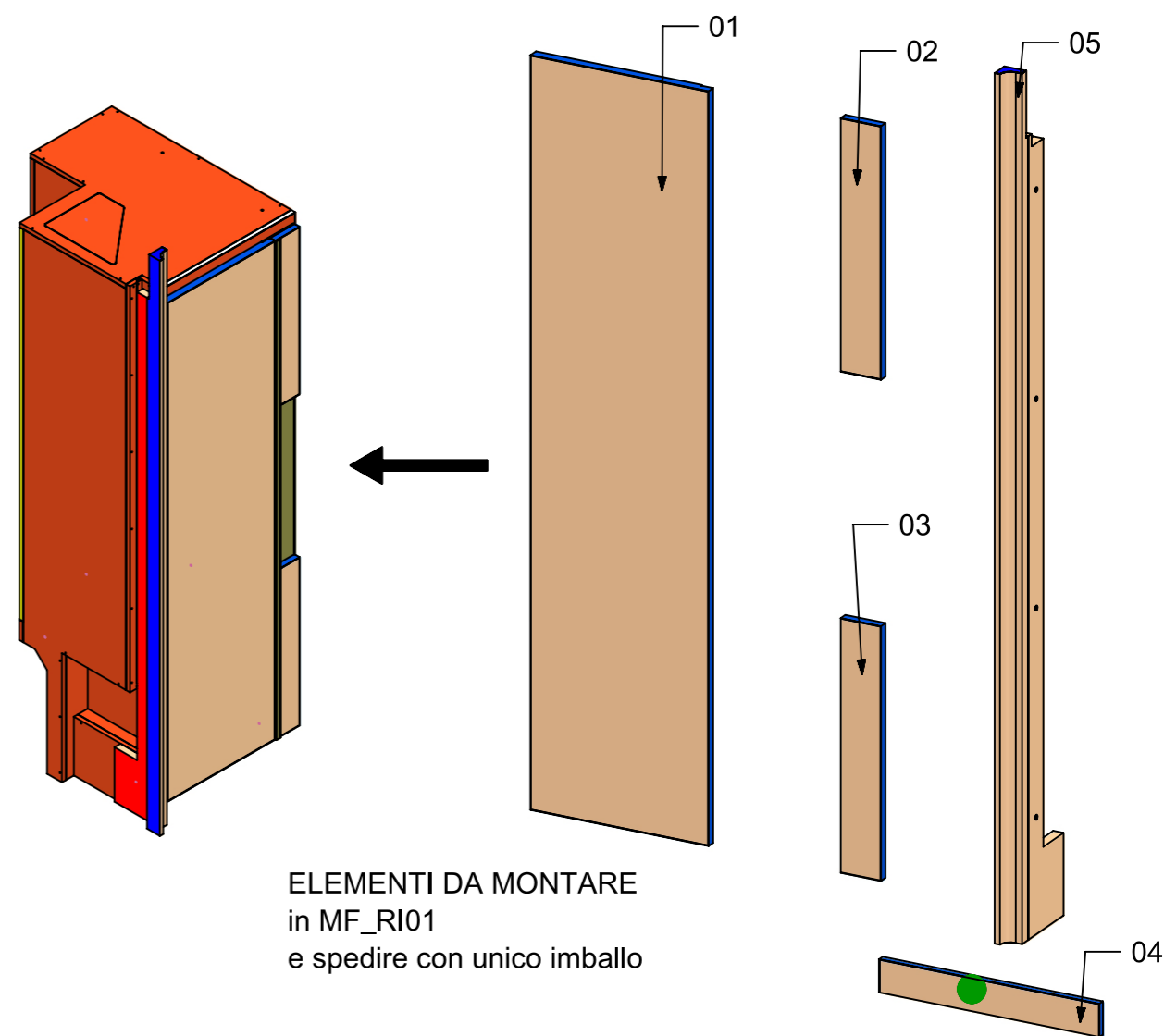
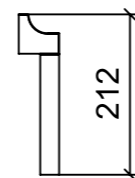

ELEMENTI DA MONTARE
in MF_RI01
e spedire con unico imballo

FERRAMENTA	QTY
BUSSOLA 6MA X 10 FORO DIAM.8	4
MAGNETE FORZA MAGNETICA1-5 10KG_HAFELE_246.87.112	2
BUSSOLA 5MA ANKOR BORGHIS X CERNIERA PIANA	8
BUSSOLA AD ESPANSIONE_HAFELE_042.98.051	4

VERNICIATURA LASTRA/LACCATI:

● = VERNICIARE 1 LATO + FILI RASATI O BORDATI

NESSUN SIMBOLO = VERNICIARE 2 LATI + FILI RASATI O BORDATI