

LOCALE	CODICE	DESCRIZIONE COMPONENTE	FINITURA	GR.
BAGNO OSPITI DX	MD320_R02_ZA01	STRUTTURA PENSILE A MURATA	LASTRA CHIARA	4

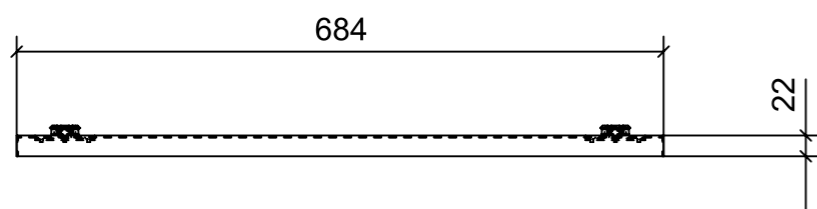

01

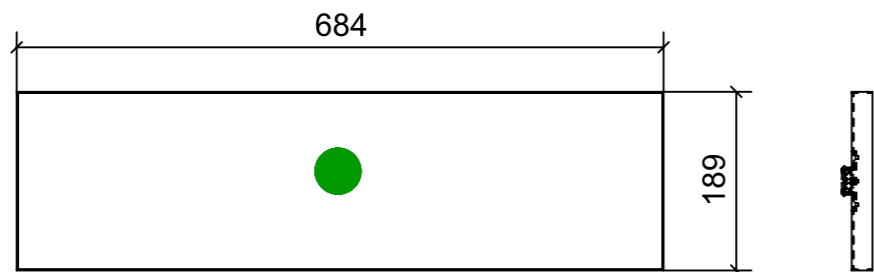
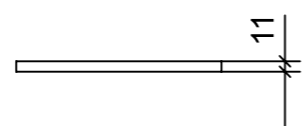
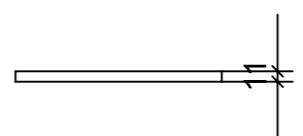
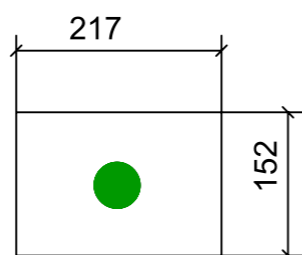
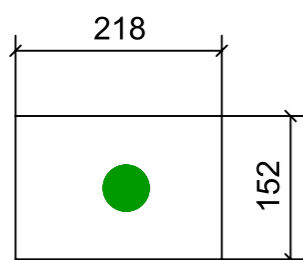

02

03

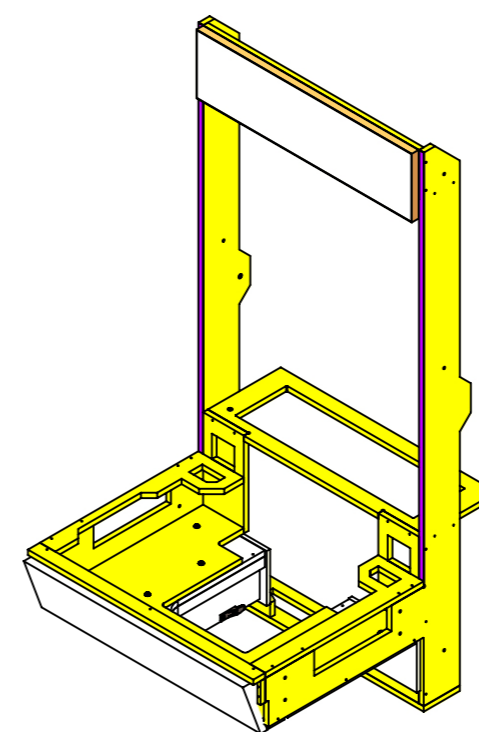
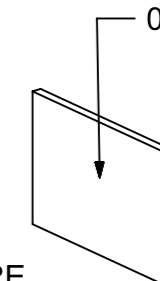
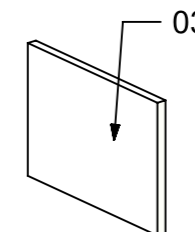
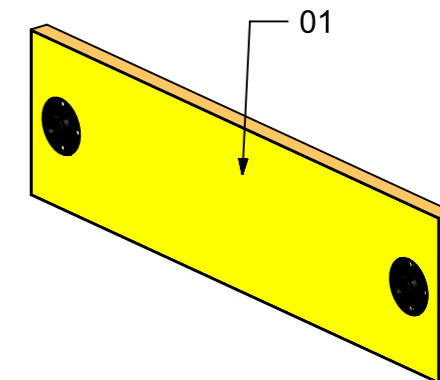

ELEMENTI DA MONTARE
in MF_ZA01
e spedire con unico imballo

FERRAMENTA	QTY
FITLOCK M_MASCHERPA_3MM_6020202101	2

VERNICIATURA LASTRA/LACCATI:

● = VERNICIARE 1 LATO + FILI RASATI O BORDATI

NESSUN SIMBOLO = VERNICIARE 2 LATI + FILI RASATI O BORDATI

LOCALE	CODICE	DESCRIZIONE COMPONENTE	FINITURA	GR.
BAGNO OSPITI DX	MD320_R02_ZB01	PENSILE A MURATA	LASTRA CHIARA	4

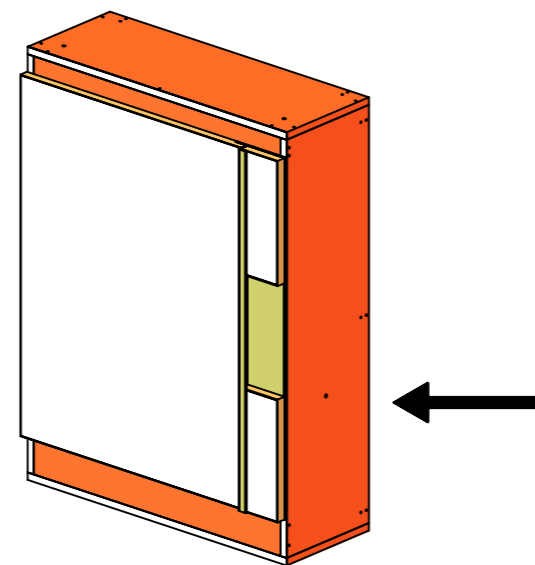
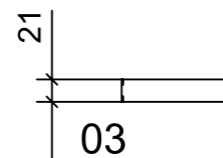
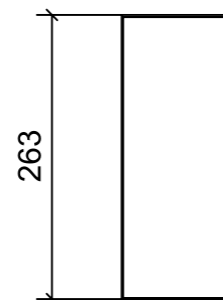
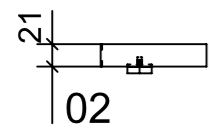
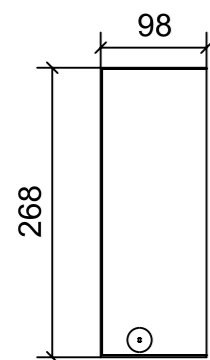
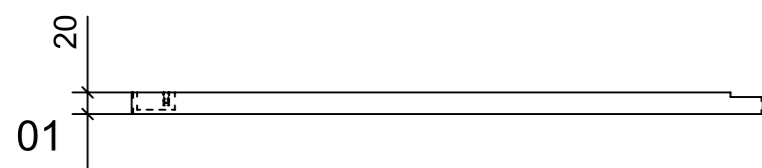
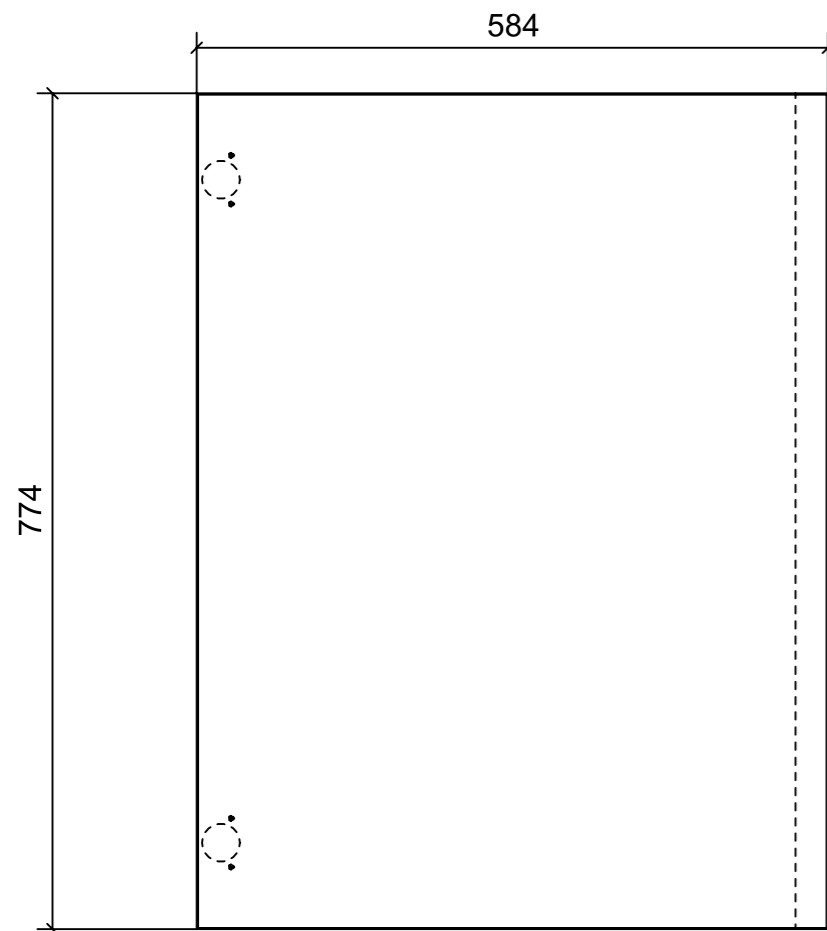

ELEMENTI DA MONTARE
in MF_ZB01
e spedire con unico imballo

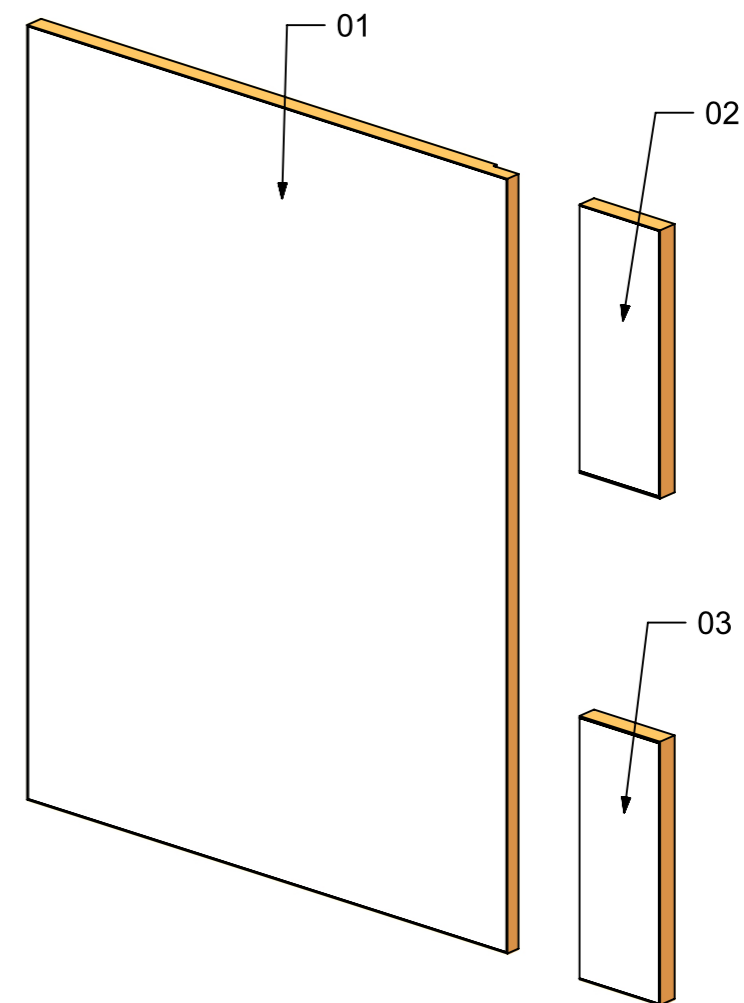

FERRAMENTA	QTY
BUSSOLA 5MA ANKOR BORGHI X CERNIERA PIANA	4
MAGNETE FORZA MAGNETICA1-5 10KG_HAFELE_246.87.112	1

VERNICIATURA LASTRA/LACCATI:

● = VERNICIARE 1 LATO + FILI RASATI O BORDATI

NESSUN SIMBOLO = VERNICIARE 2 LATI + FILI RASATI O BORDATI

LOCALE	CODICE	DESCRIZIONE COMPONENTE	FINITURA	GR.
BAGNO OSPITI DX	MD320_R02_ZC01	RIVESTIMENTI ZONA LAVELLO	LASTRA CHIARA	3

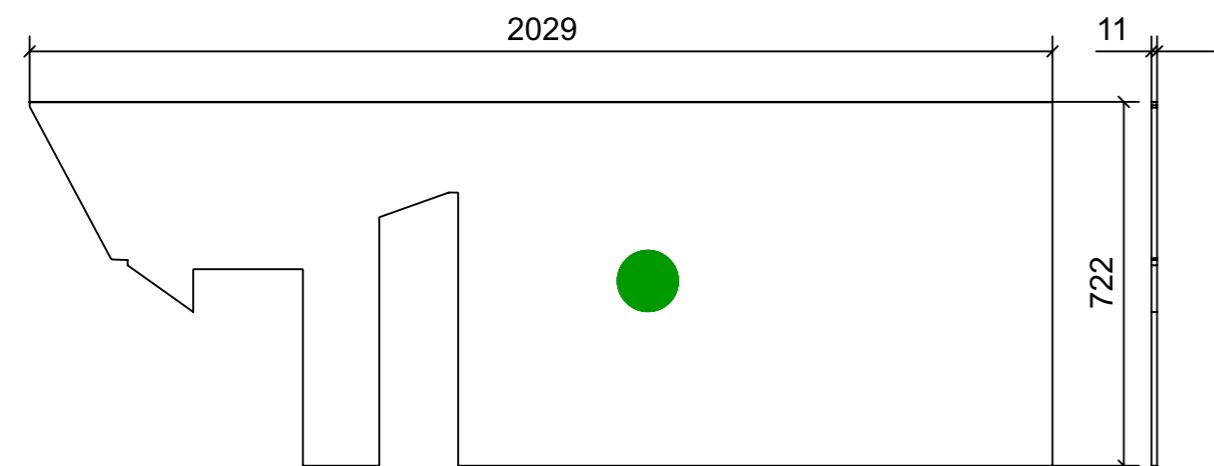

05

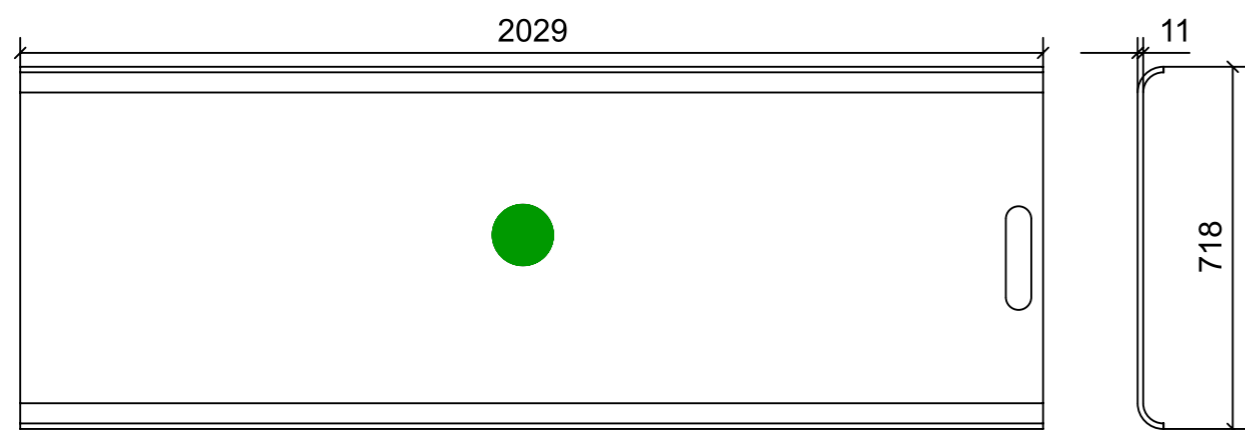

04

UNICO PEZZO DA MONTARE

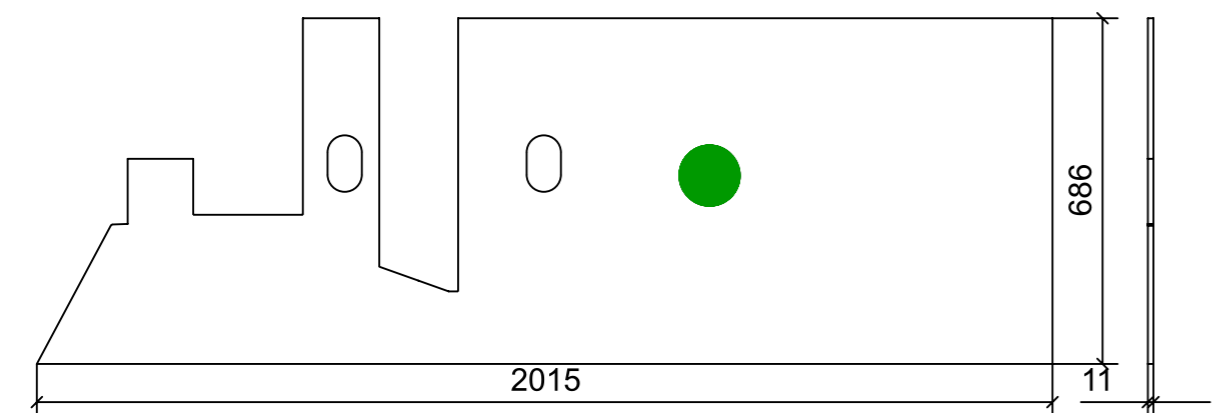

01

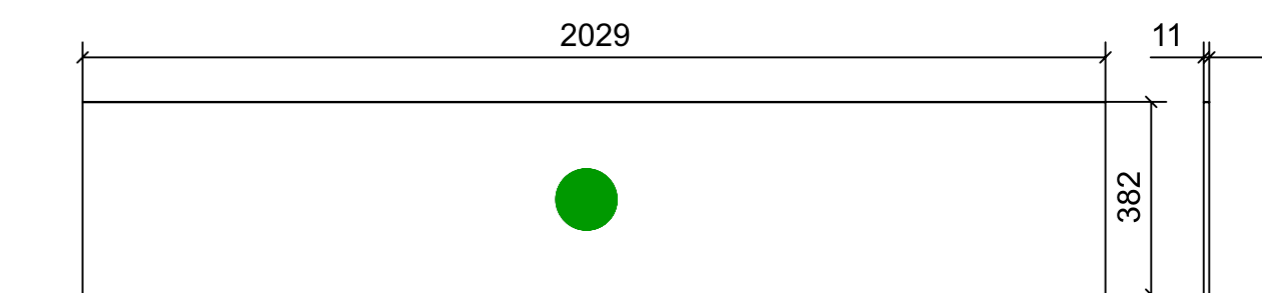

06

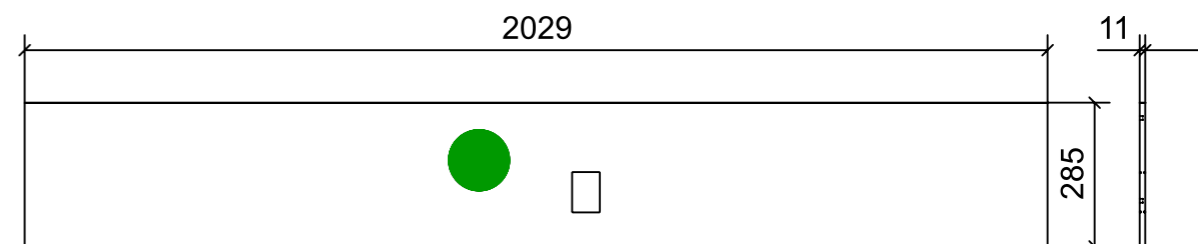

02

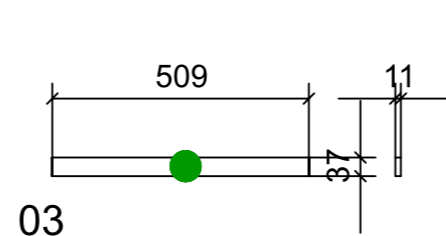

03

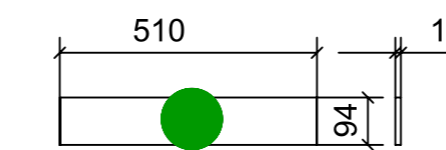

07

ELEMENTI DA MONTARE
in MF_ZC01
e spedire con unico imballo

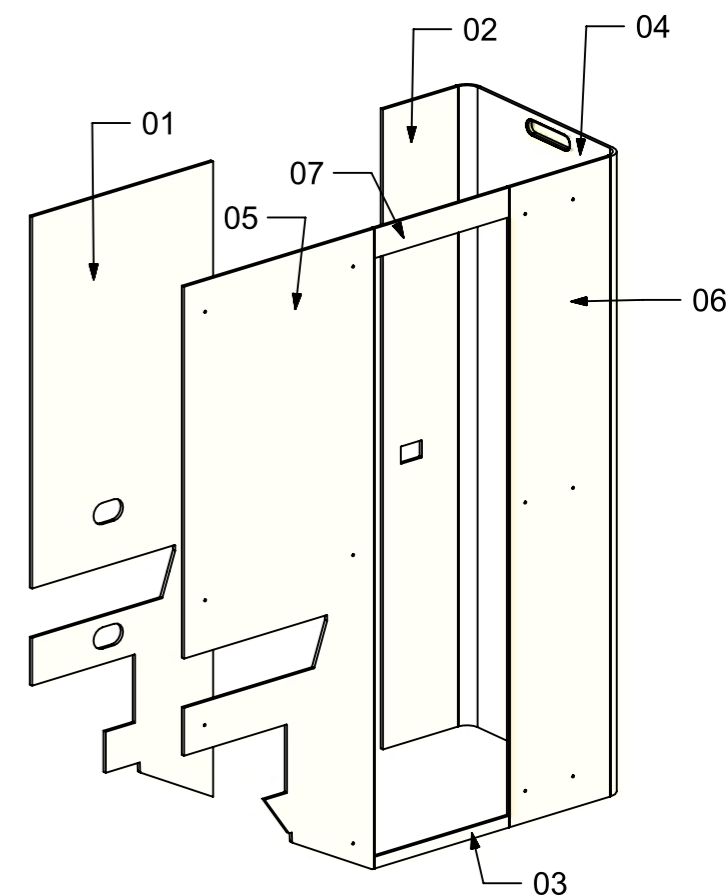
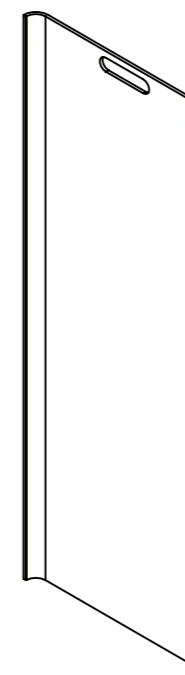

VERNICIATURA LASTRA/LACCATI:

● = VERNICIARE 1 LATO + FILI RASATI O BORDATI

NESSUN SIMBOLO = VERNICIARE 2 LATI + FILI RASATI O BORDATI

LOCALE	CODICE	DESCRIZIONE COMPONENTE	FINITURA	GR.
BAGNO OSPITI DX	MD320_R01_ZD01	MOBILE SOTTO LAVELLO	LASTRA SCURA	4

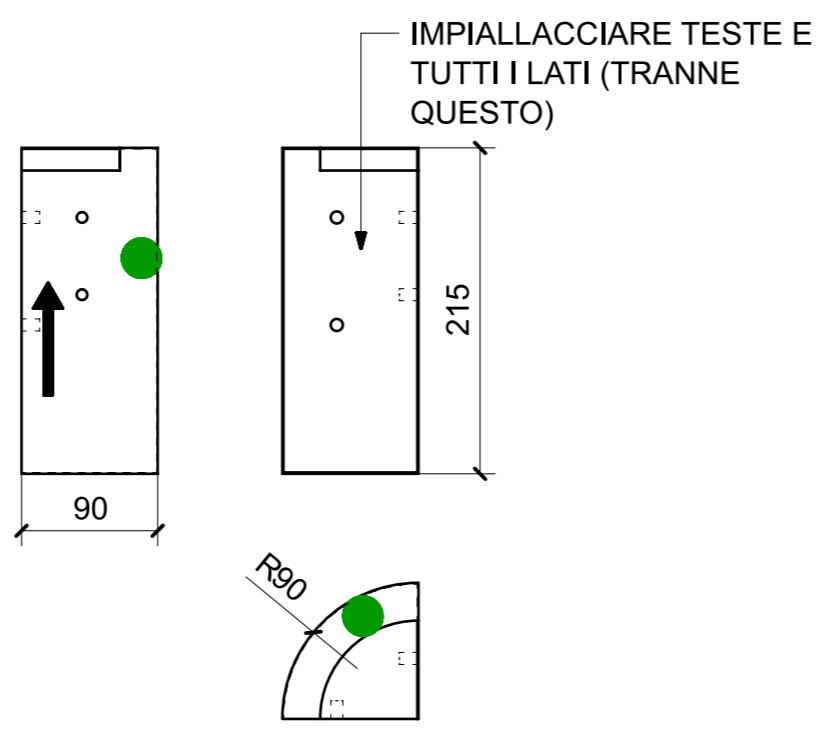
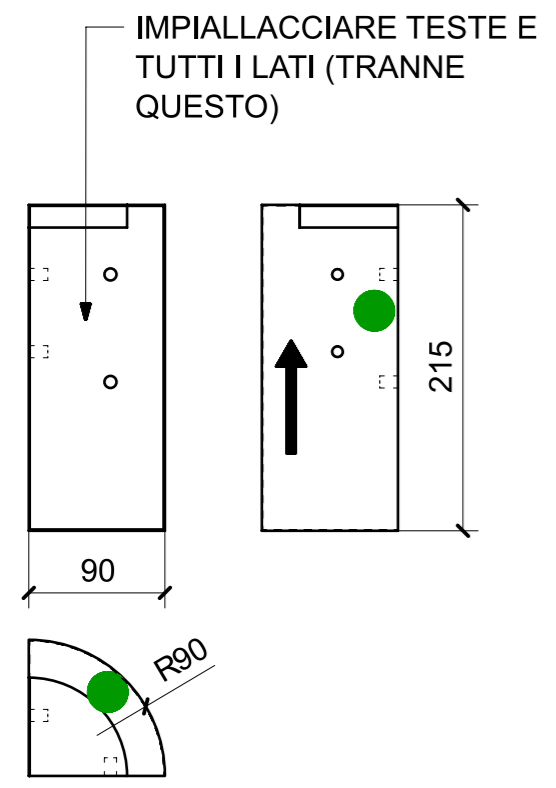
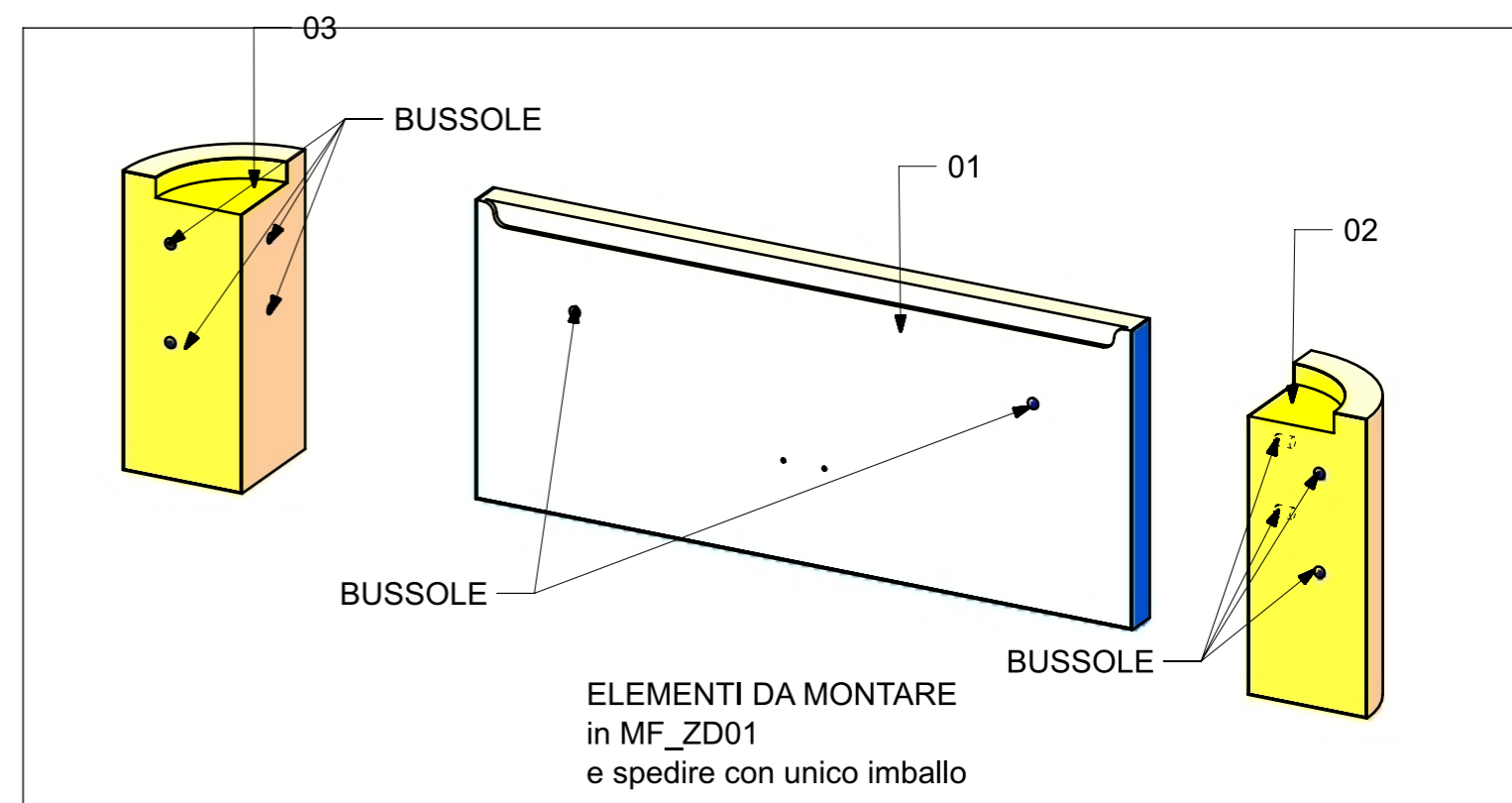
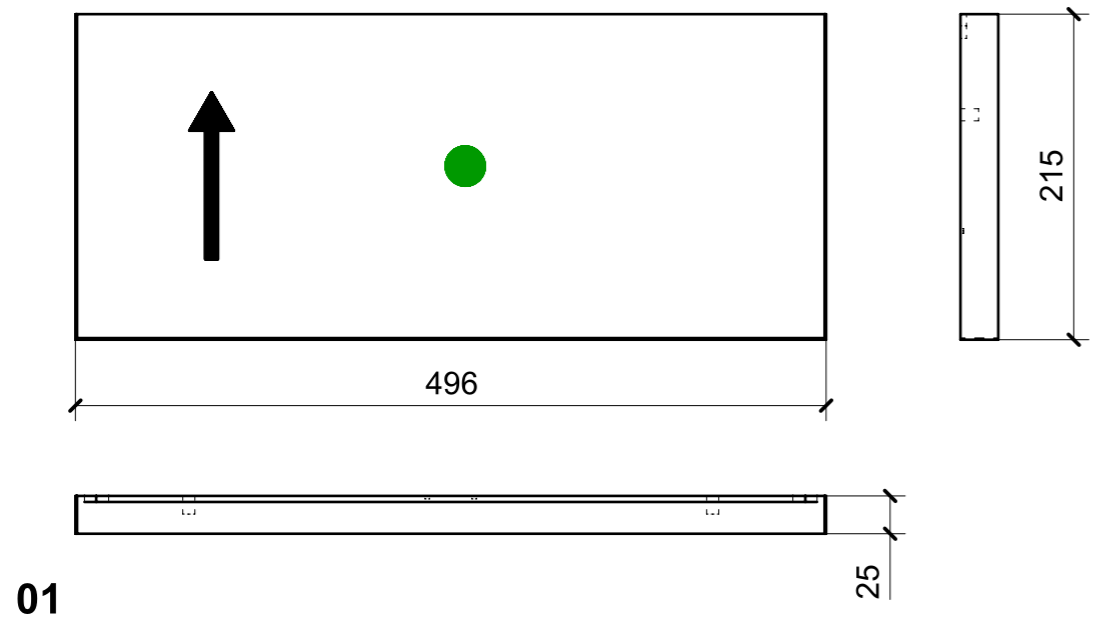

FERRAMENTA	QTY
BUSSOLA 6MA X 10 FORO DIAM.8	10
PLACCHETTA COUNTER STEEL_TECHNOPARTNER_MC-JM49	1

VERNICIATURA LASTRA/LACCATI:
 ● = VERNICIARE 1 LATO + FILI RASATI O BORDATI NESSUN SIMBOLO = VERNICIARE 2 LATI + FILI RASATI O BORDATI

LOCALE	CODICE	DESCRIZIONE COMPONENTE	FINITURA	GR.
BAGNO OSPITI DX	MD320_R04_ZN01	SEDUTA DOCCIA	IROKO DOGATO	2

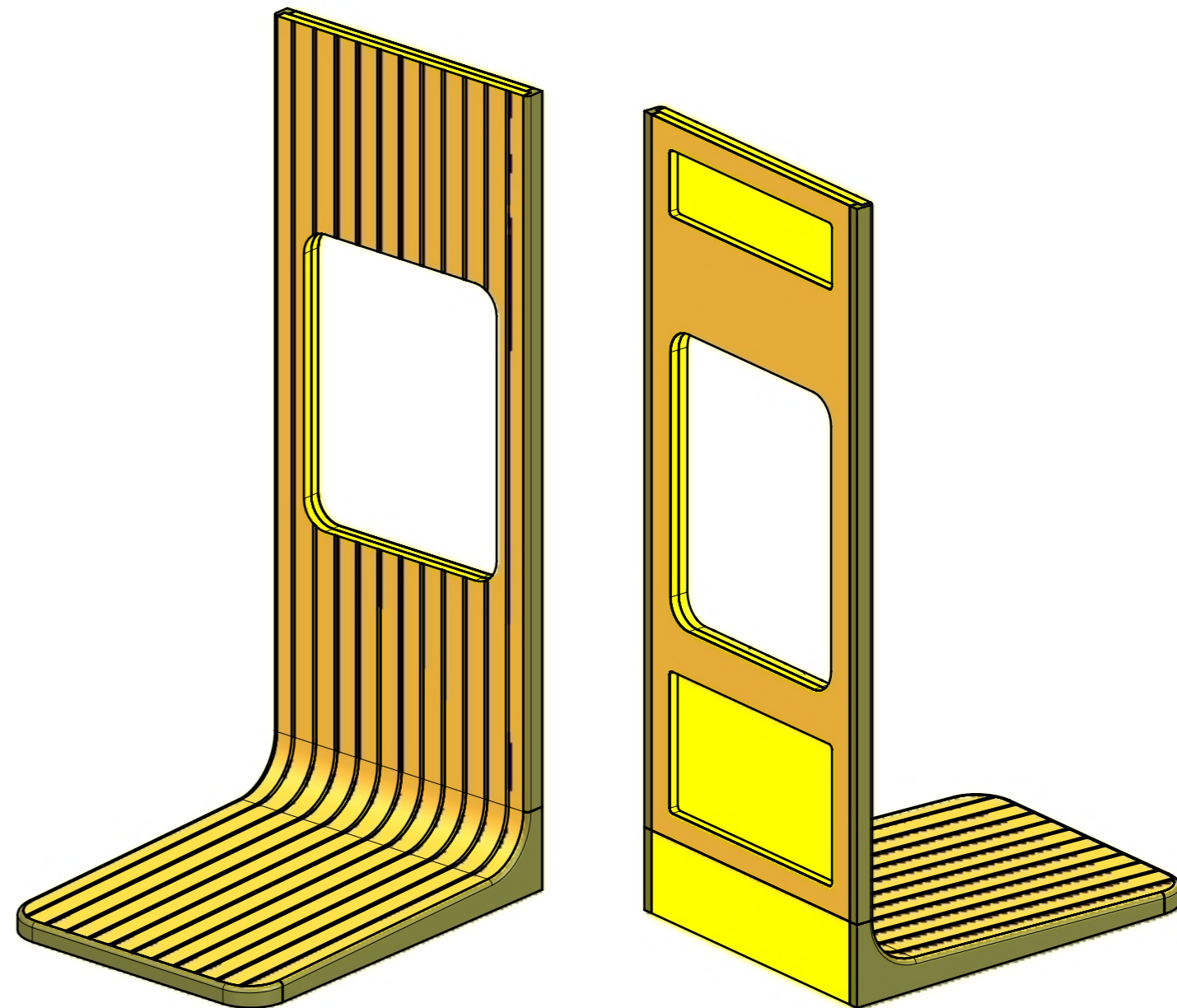
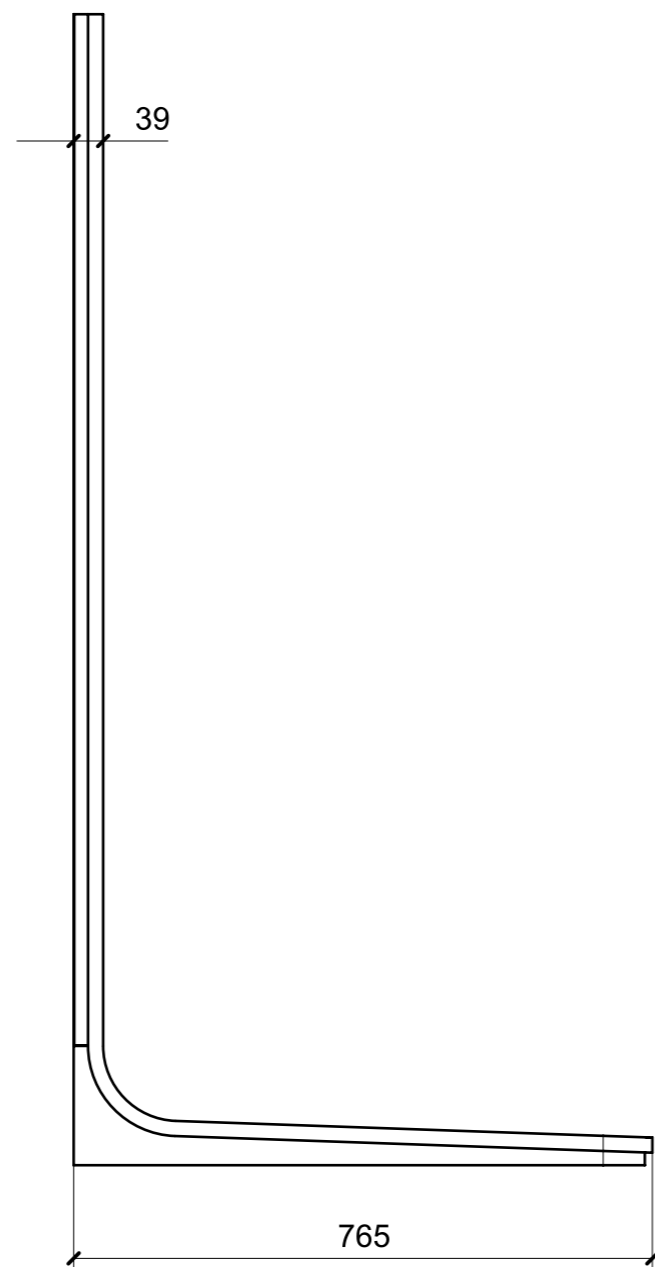
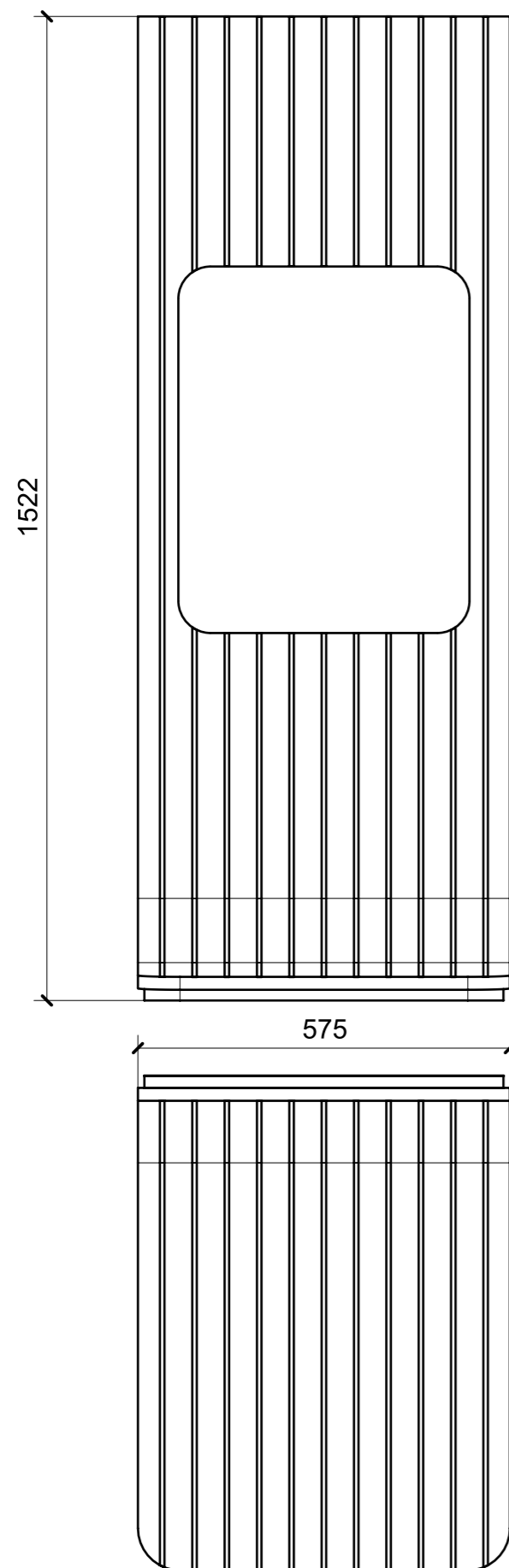

ELEMENTO DA MONTARE
 con LACCATI BRONZO
 in MF_ZN01
 e spedire con unico imballo

VERNICIATURA LASTRA/LACCATI:

● = VERNICIARE 1 LATO + FILI RASATI O BORDATI

NESSUN SIMBOLO = VERNICIARE 2 LATI + FILI RASATI O BORDATI