

LOCALE	CODICE	DESCRIZIONE COMPONENTE	FINITURA	GR.
LOBBY LD	MD320_L01_CB01	RIVESTIMENTI POPPA DX	LACCATO BRONZO	2

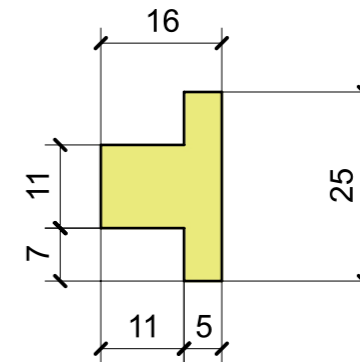
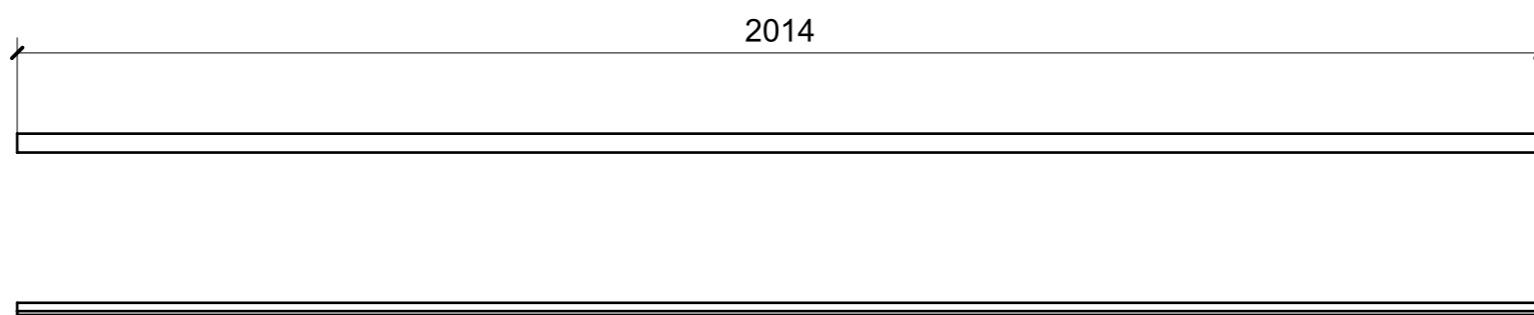
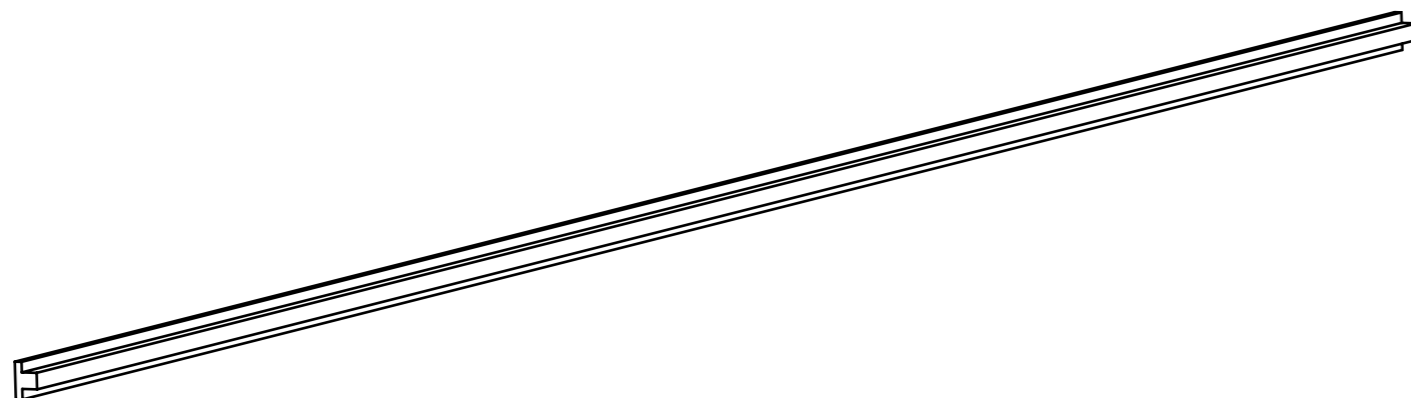

VERNICIATURA LASTRA/LACCATI:

● = FILI RASATI

● = VERNICIARE 1 LATO + FILI RASATI O BORDATI

NESSUN SIMBOLO = VERNICIARE 2 LATI + FILI RASATI O BORDATI

LOCALE	CODICE	DESCRIZIONE COMPONENTE	FINITURA	GR.
LOBBY LD	MD320_L01_CC01	RIVESTIMENTI INGRESSO CABINA OSPITI DX	LACCATO BRONZO	3

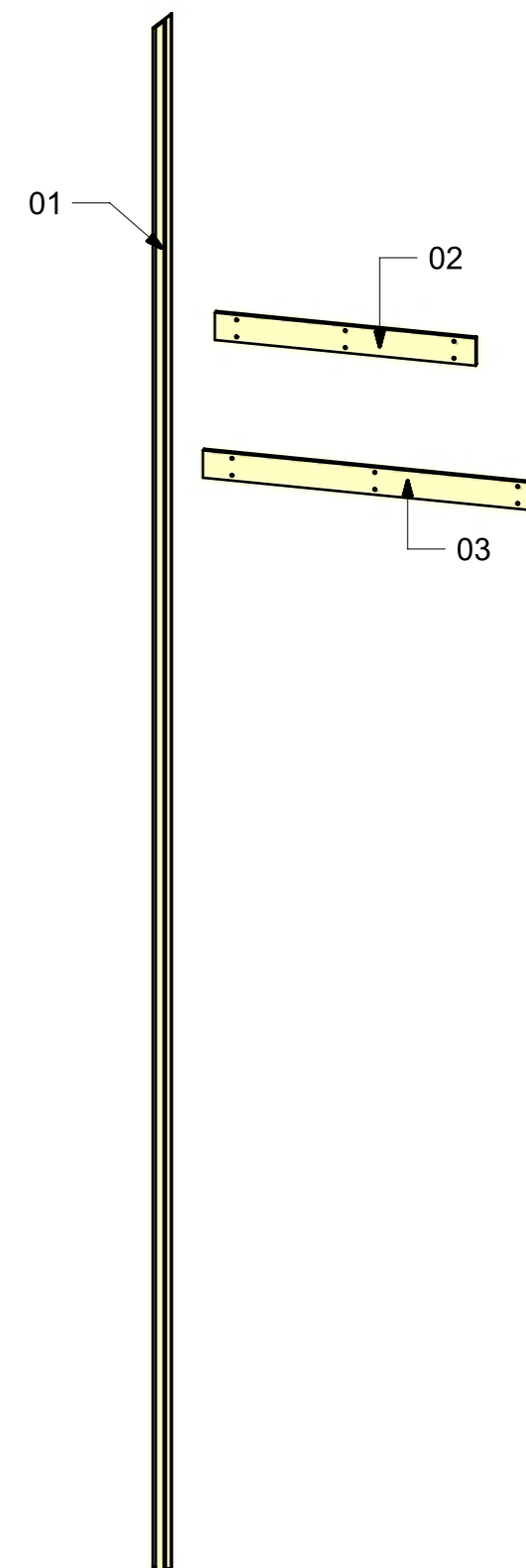
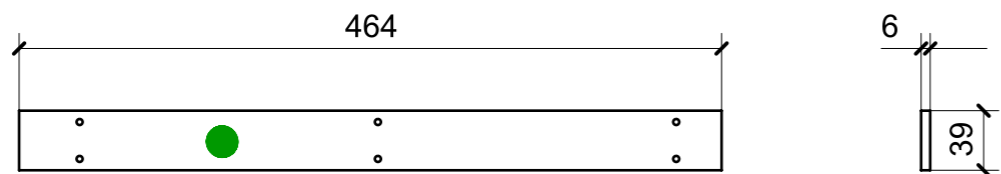
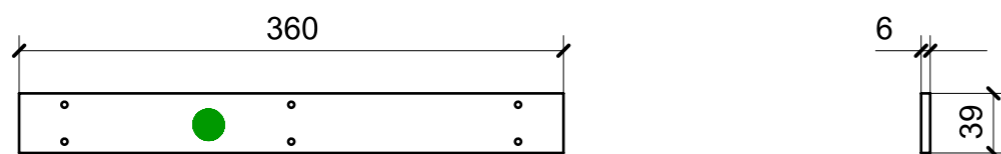
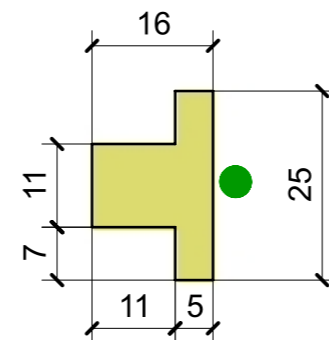
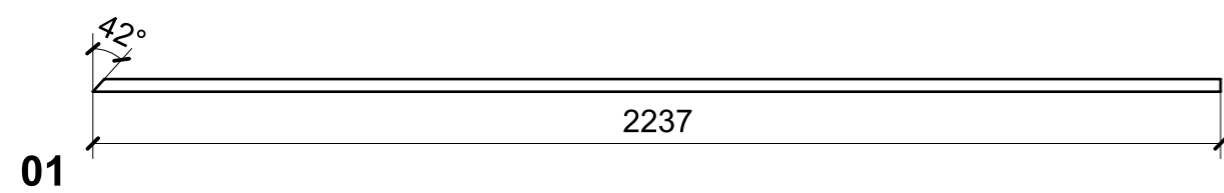

VERNICIATURA LASTRA/LACCATI:

● = FILI RASATI

● = VERNICIARE 1 LATO + FILI RASATI O BORDATI

NESSUN SIMBOLO = VERNICIARE 2 LATI + FILI RASATI O BORDATI

LOCALE	CODICE	DESCRIZIONE COMPONENTE	FINITURA	GR.
LOBBY LD	MD320_L01_CD01	RIVESTIMENTI TRAVERSONAVE DISCESA SCALE POPPA	LACCATO BRONZO	PTP

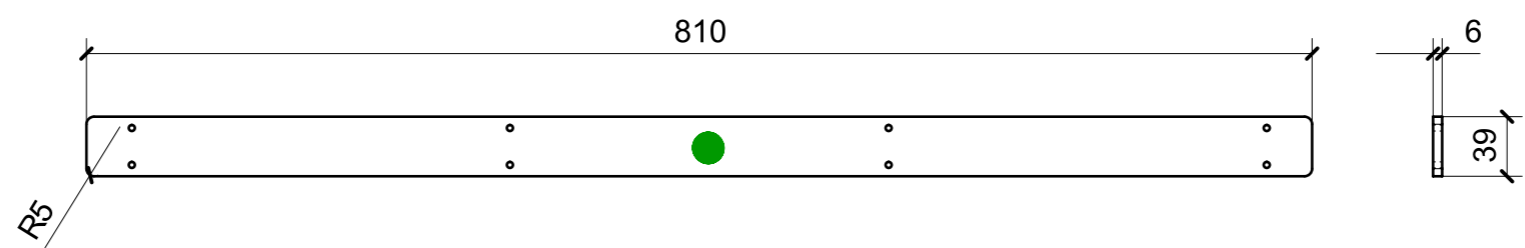
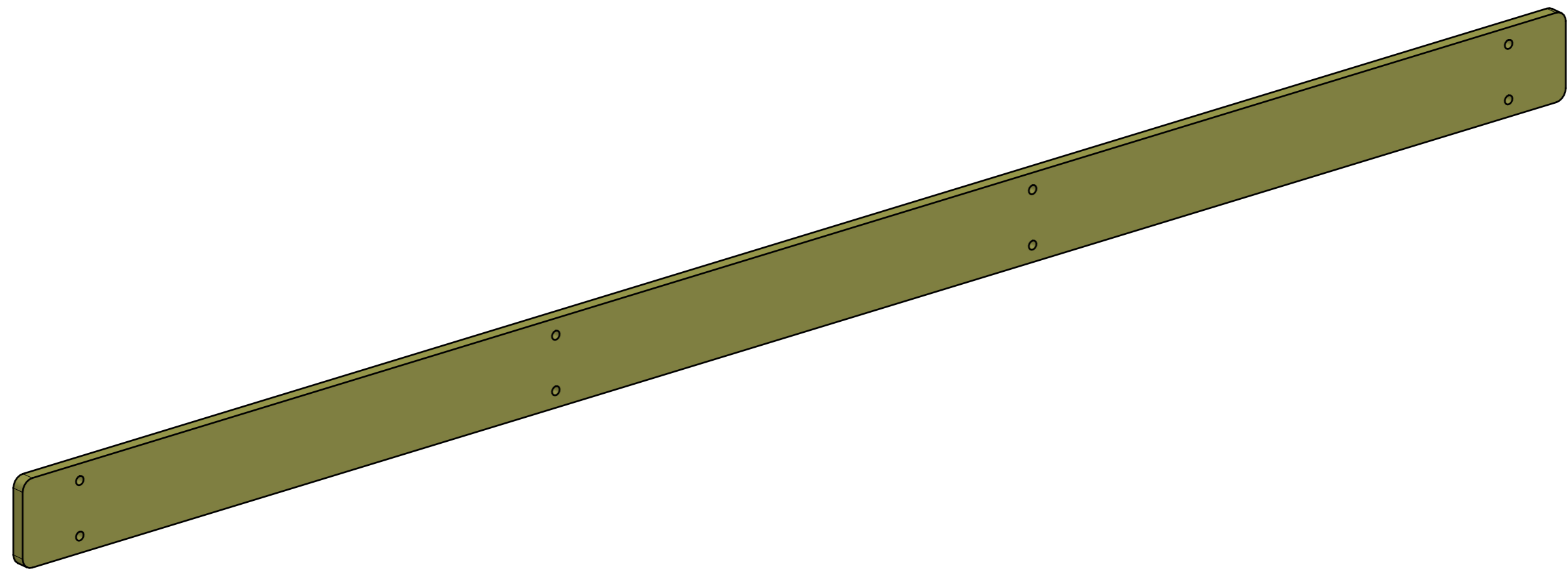

● = FILI RASATI
 ● = VERNICIARE 1 LATO + FILI RASATI O BORDATI
 NESSUN SIMBOLO = VERNICIARE 2 LATI + FILI RASATI O BORDATI

LOCALE	CODICE	DESCRIZIONE COMPONENTE	FINITURA	GR.
LOBBY LD	MD320_L01_CE01	RIVESTIMENTI POPPA SX	LACCATO BRONZO	3

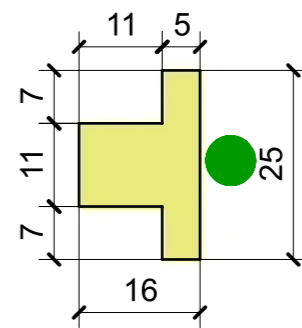
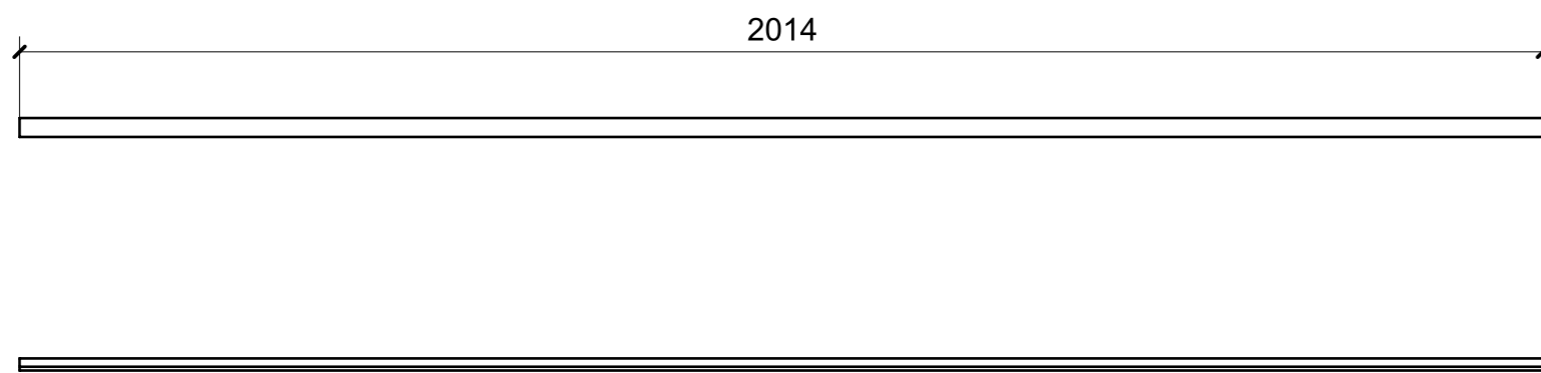
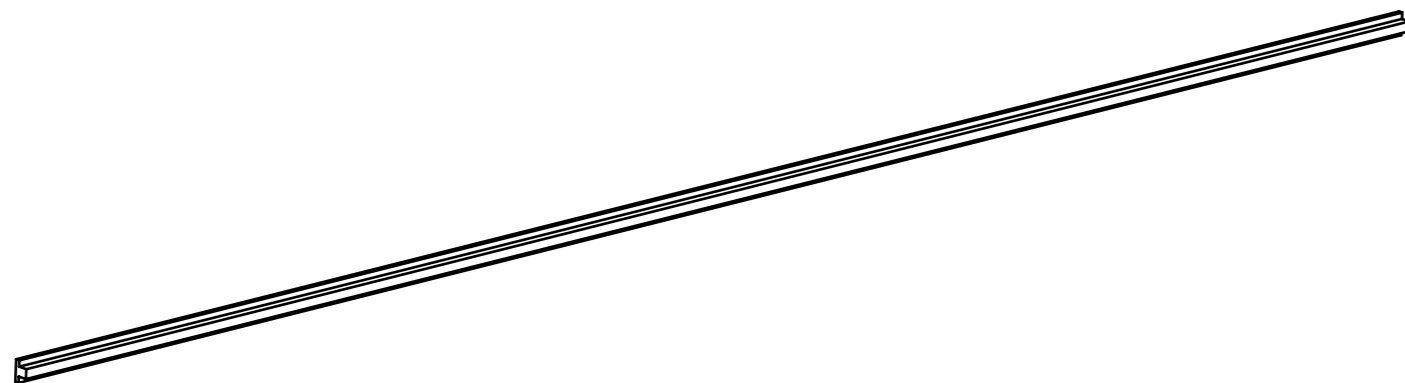

● = FILI RASATI

● = VERNICIARE 1 LATO + FILI RASATI O BORDATI

NESSUN SIMBOLO = VERNICIARE 2 LATI + FILI RASATI O BORDATI

LOCALE	CODICE	DESCRIZIONE COMPONENTE	FINITURA	GR.
LOBBY LD	MD320_L01_CG01	RIVESTIMENTI TRAVERSONAVE DISCESA SCALE PRUA	LACCATO BRONZO	2

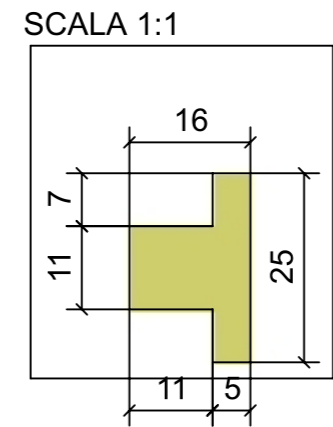
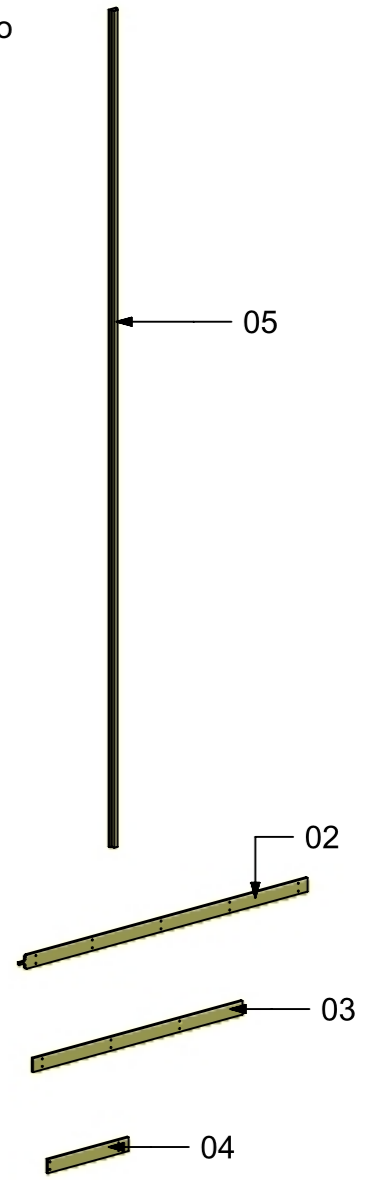
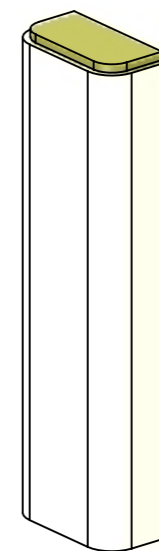
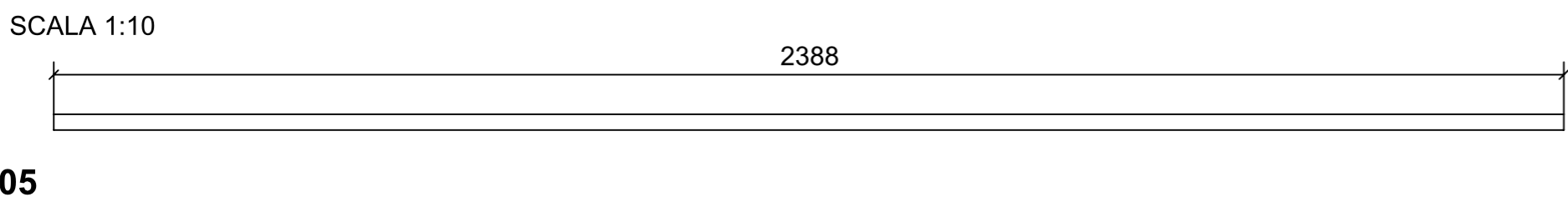
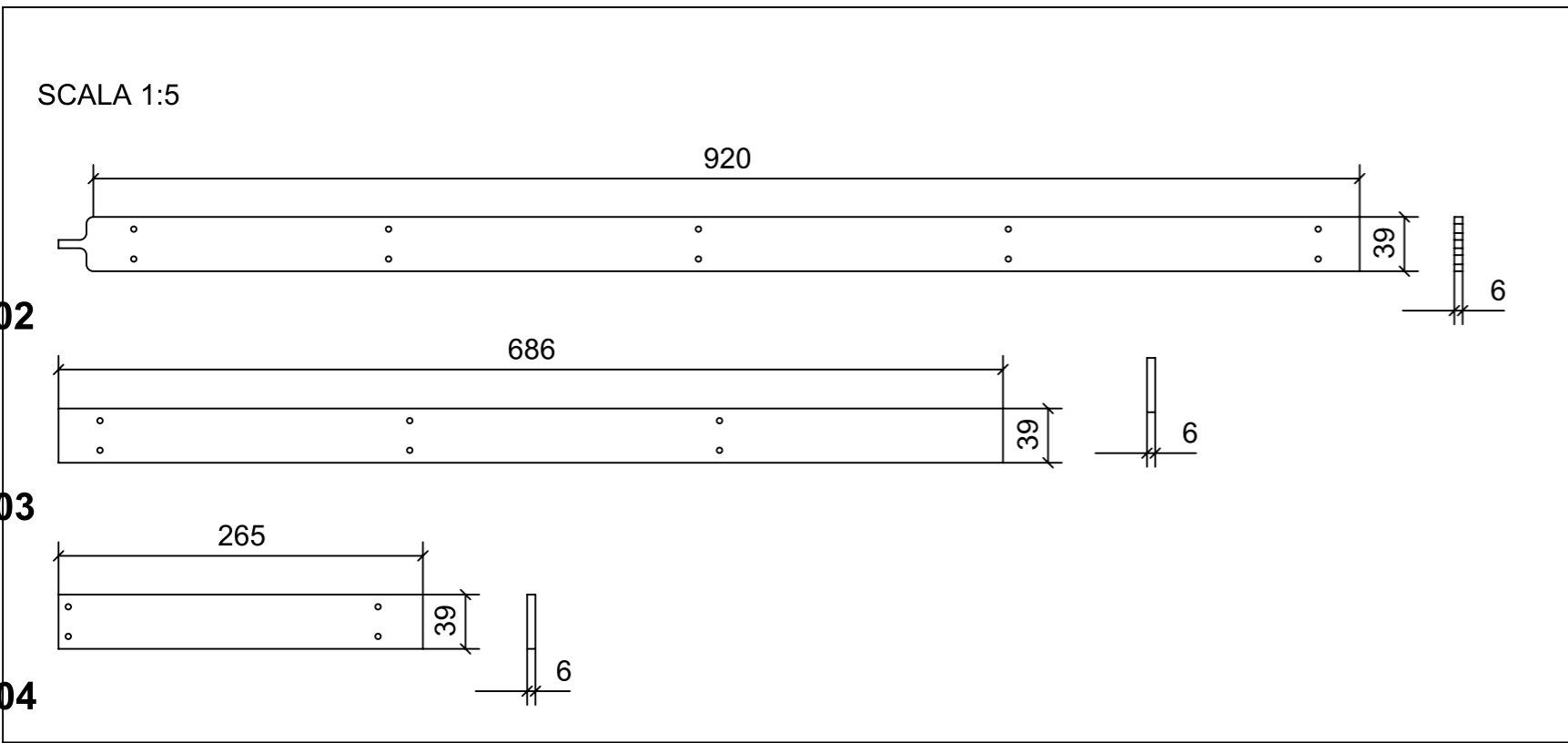
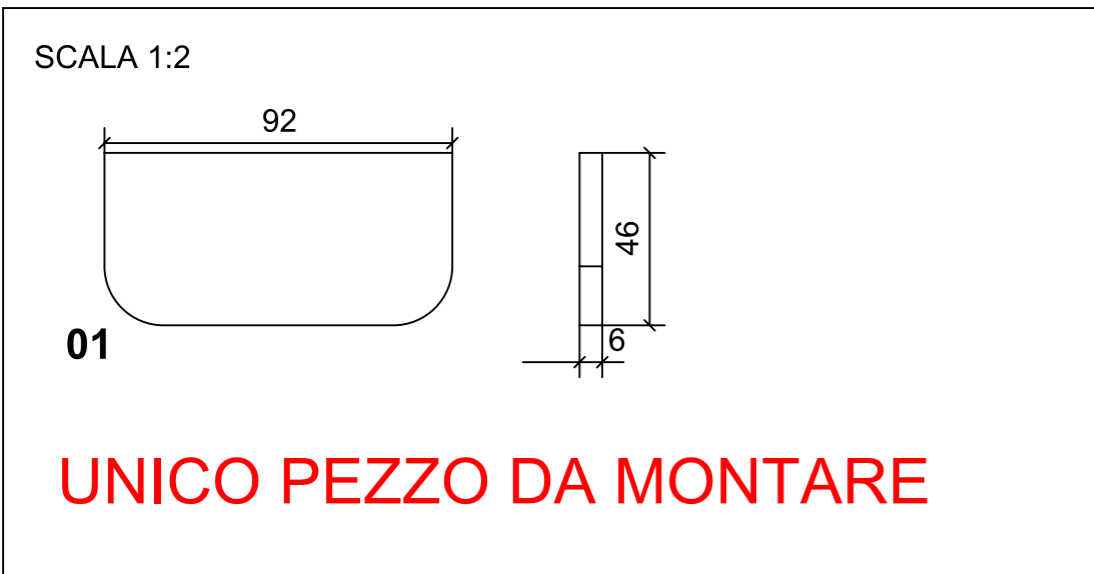

VERNICIATURA LASTRA/LACCATI:
● = VERNICIARE 1 LATO + FILI RASATI O BORDATI
 NESSUN SIMBOLO = VERNICIARE 2 LATI + FILI RASATI O BORDATI

LOCALE	CODICE	DESCRIZIONE COMPONENTE	FINITURA	GR.
LOBBY LD	MD320_L02_CG01	RIVESTIMENTI TRAVERSONAVE DISCESA SCALE PRUA	EULITE LACCATO NCS- S - 1002-Y -MANOPESCA	2

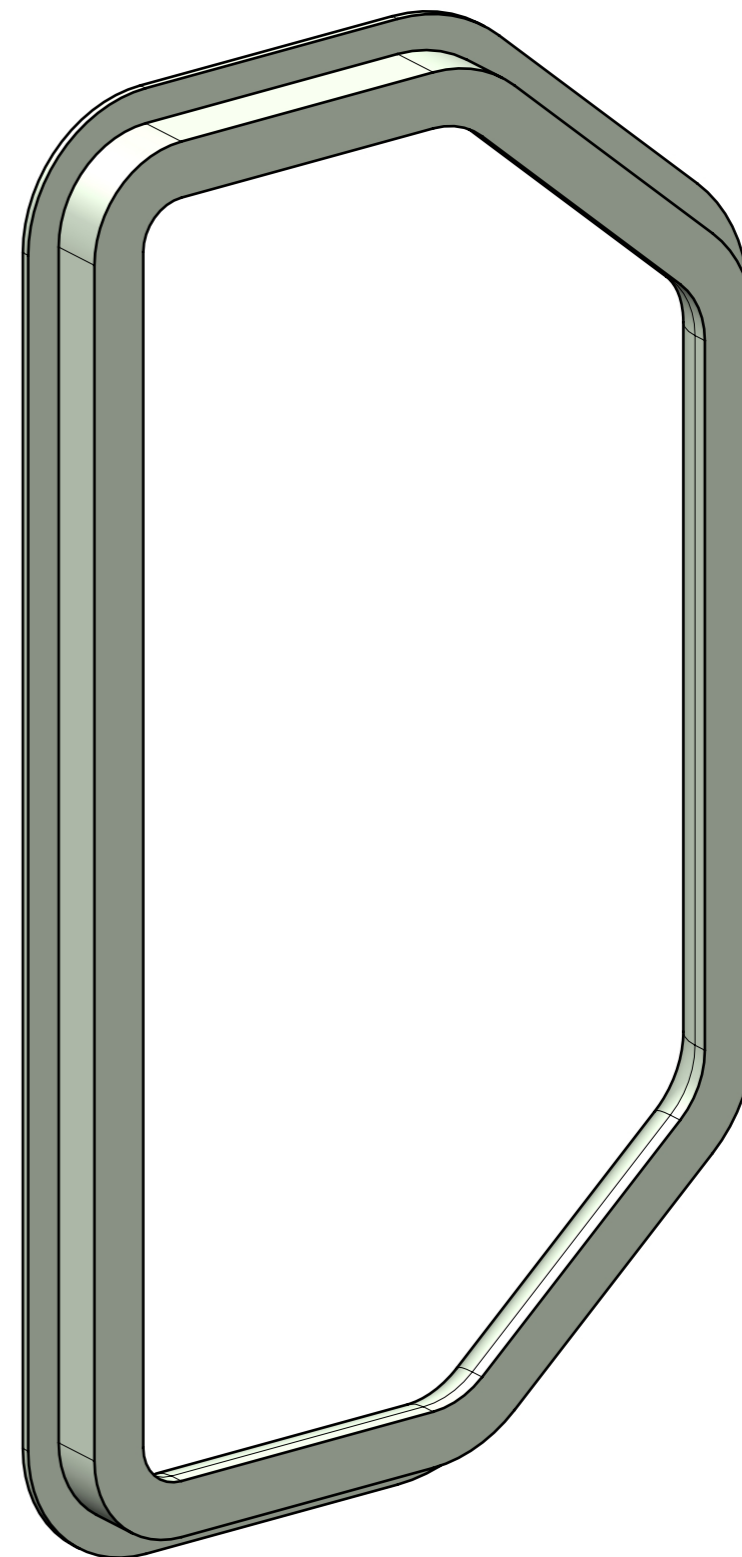
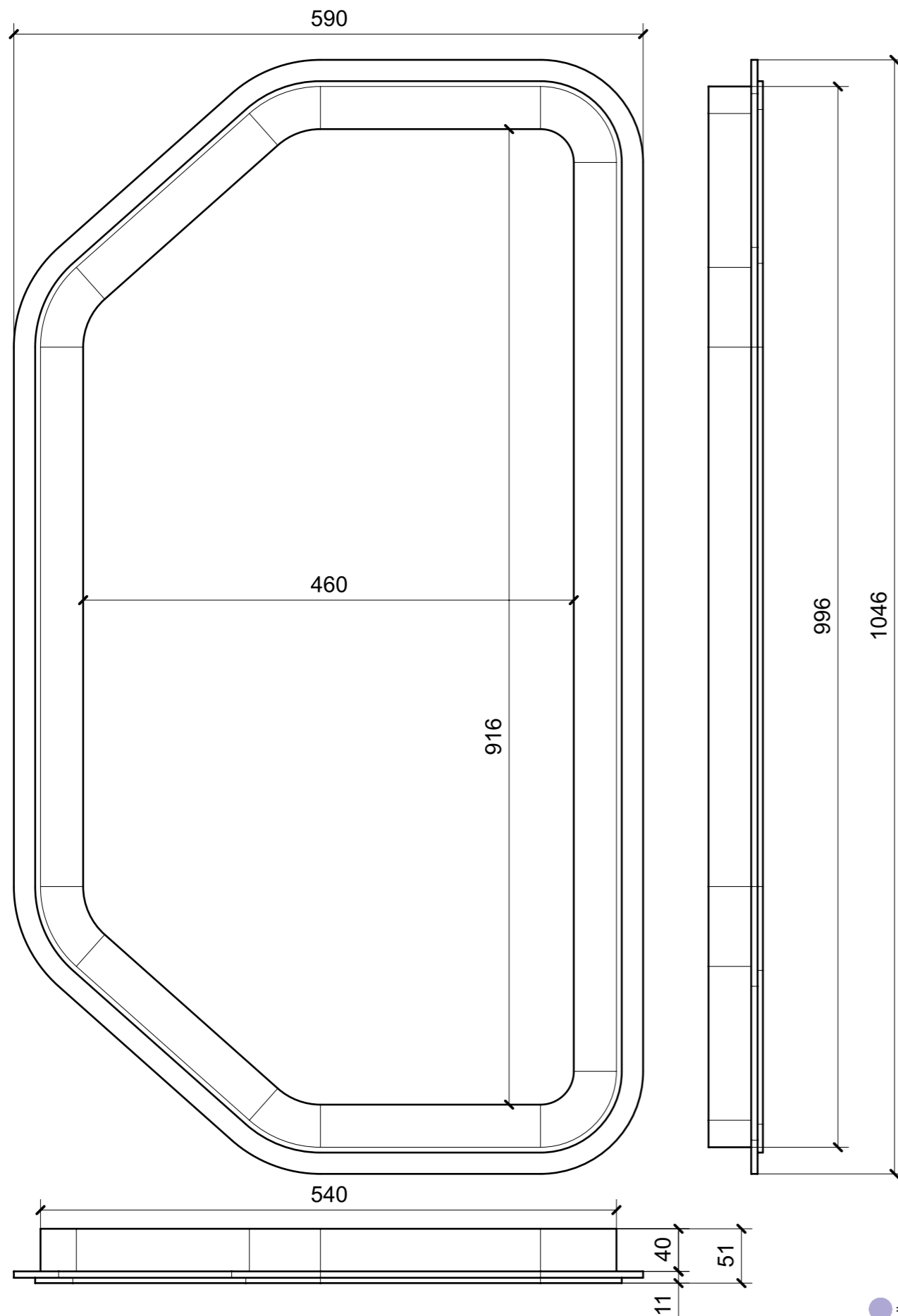

VERNICIATURA LASTRA/LACCATI:

● = FILI RASATI

● = VERNICIARE 1 LATO + FILI RASATI O BORDATI

NESSUN SIMBOLO = VERNICIARE 2 LATI + FILI RASATI O BORDATI

LOCALE	CODICE	DESCRIZIONE COMPONENTE	FINITURA	GR.
LOBBY LD	MD320_L02_CI01	CIELINO CABINE VIP	LACCATO NCS- S - 1002-Y -MANOPESCA	4

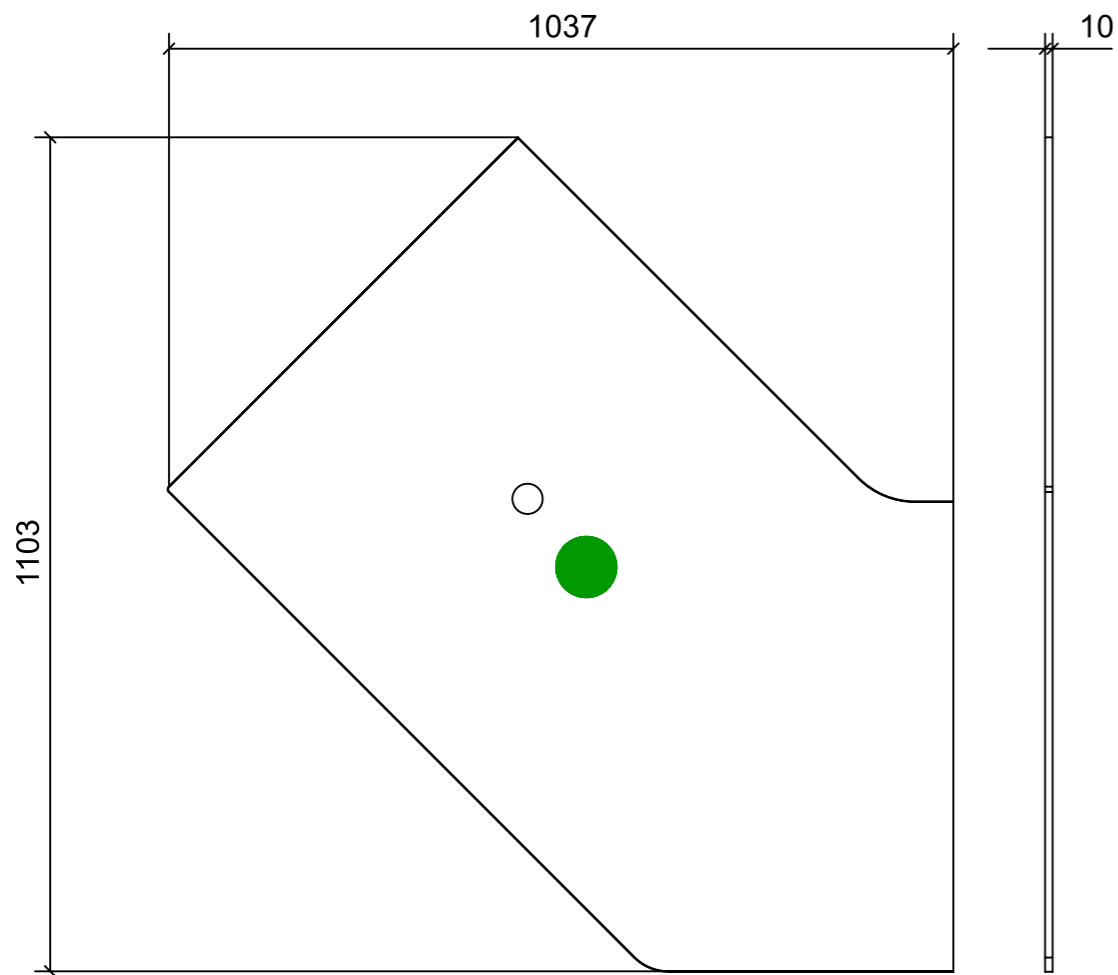

01

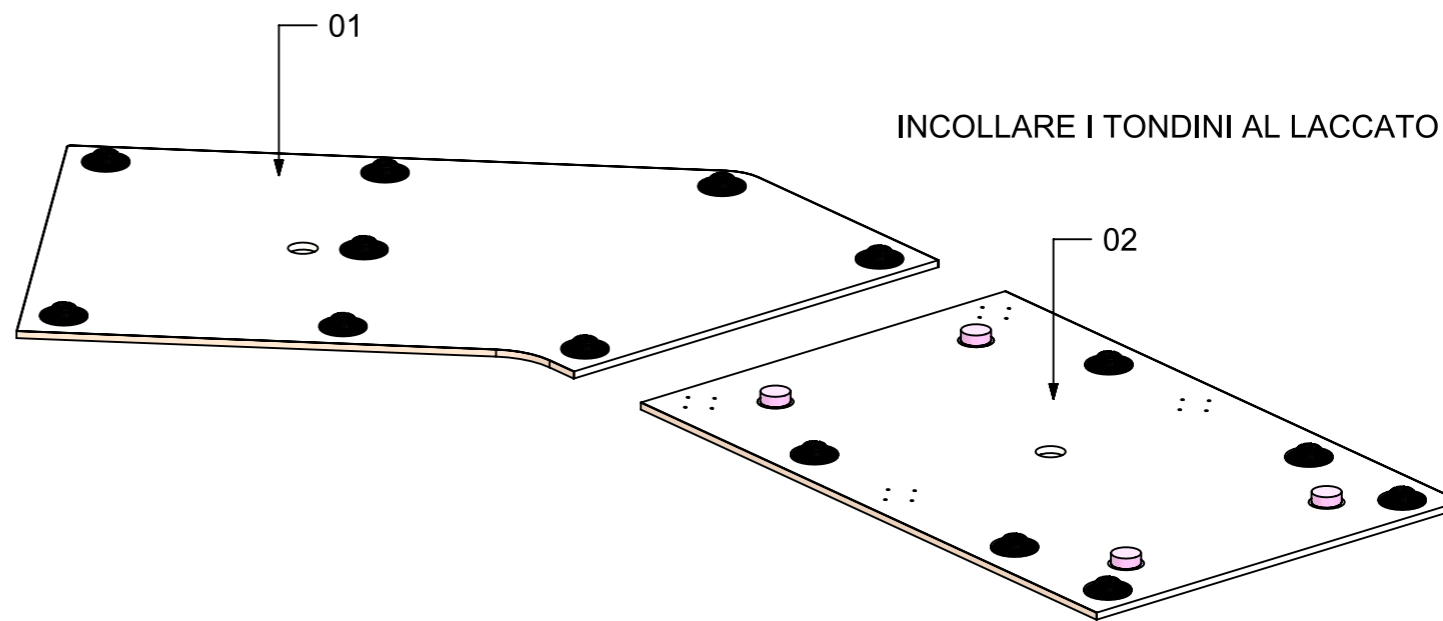

FERRAMENTA	QTY
TONDINO PER CENTRAGGIO ANTICADUTA 40X15	4
FITLOCK M_MASCHERPA_3MM_6020202101	14

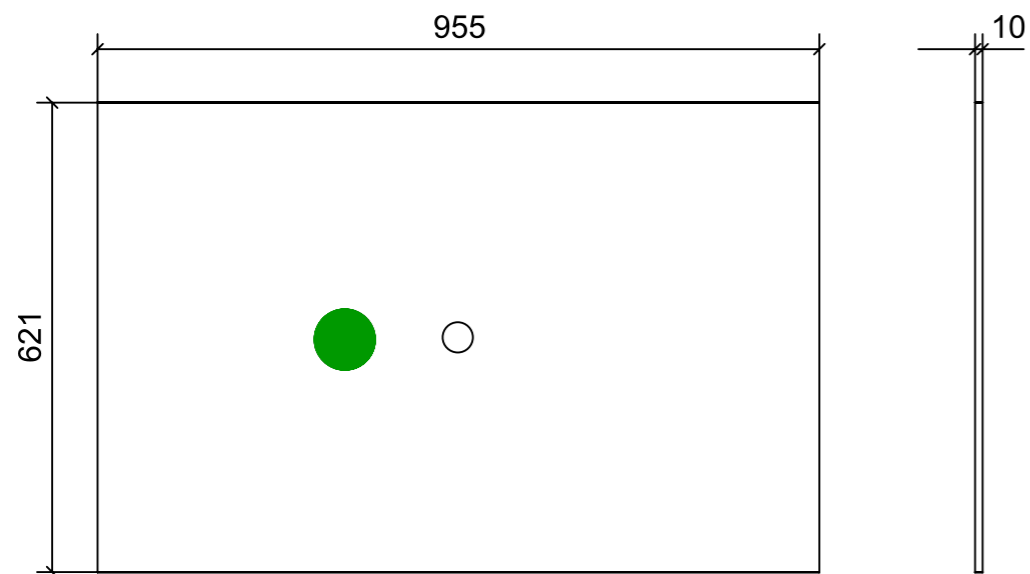

02

VERNICIATURA LASTRA/LACCATI:

● = FILI RASATI

● = VERNICIARE 1 LATO + FILI RASATI O BORDATI

NESSUN SIMBOLO = VERNICIARE 2 LATI + FILI RASATI O BORDATI

LOCALE	CODICE	DESCRIZIONE COMPONENTE	FINITURA	GR.
LOBBY LD	MD320_L02_CL01	CIELINO CABINE OSPITI	LACCATO NCS- S - 1002-Y -MANOPESCA	4

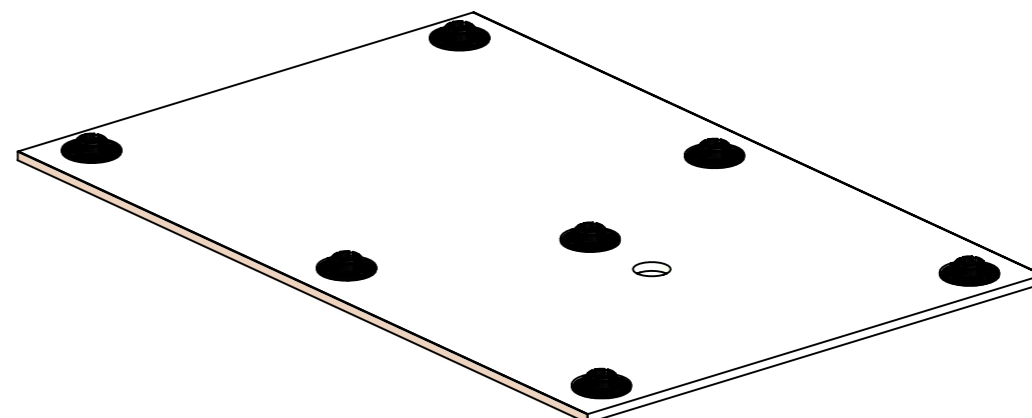
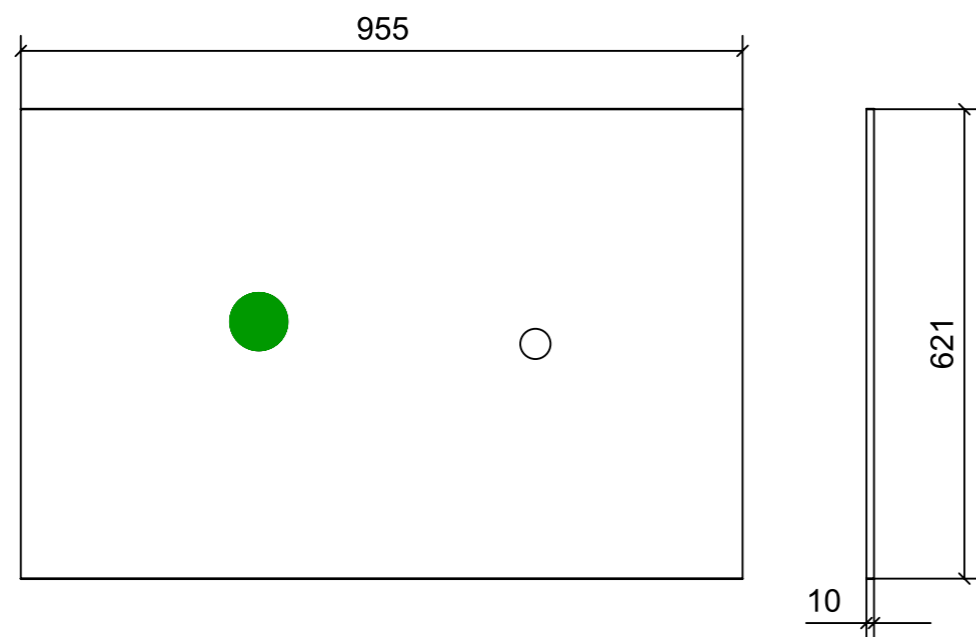

FERRAMENTA	QTY
FITLOCK M_MASCHERPA_3MM_6020202101	7

● = FILI RASATI

● = VERNICIARE 1 LATO + FILI RASATI O BORDATI

NESSUN SIMBOLO = VERNICIARE 2 LATI + FILI RASATI O BORDATI

LOCALE	CODICE	DESCRIZIONE COMPONENTE	FINITURA	GR.
LOBBY LD	MD320_L02_CM01	CIELINO DISCESA SCALE LUNGONAVE	LACCATO NCS- S - 1002-Y -MANOPESCA	4

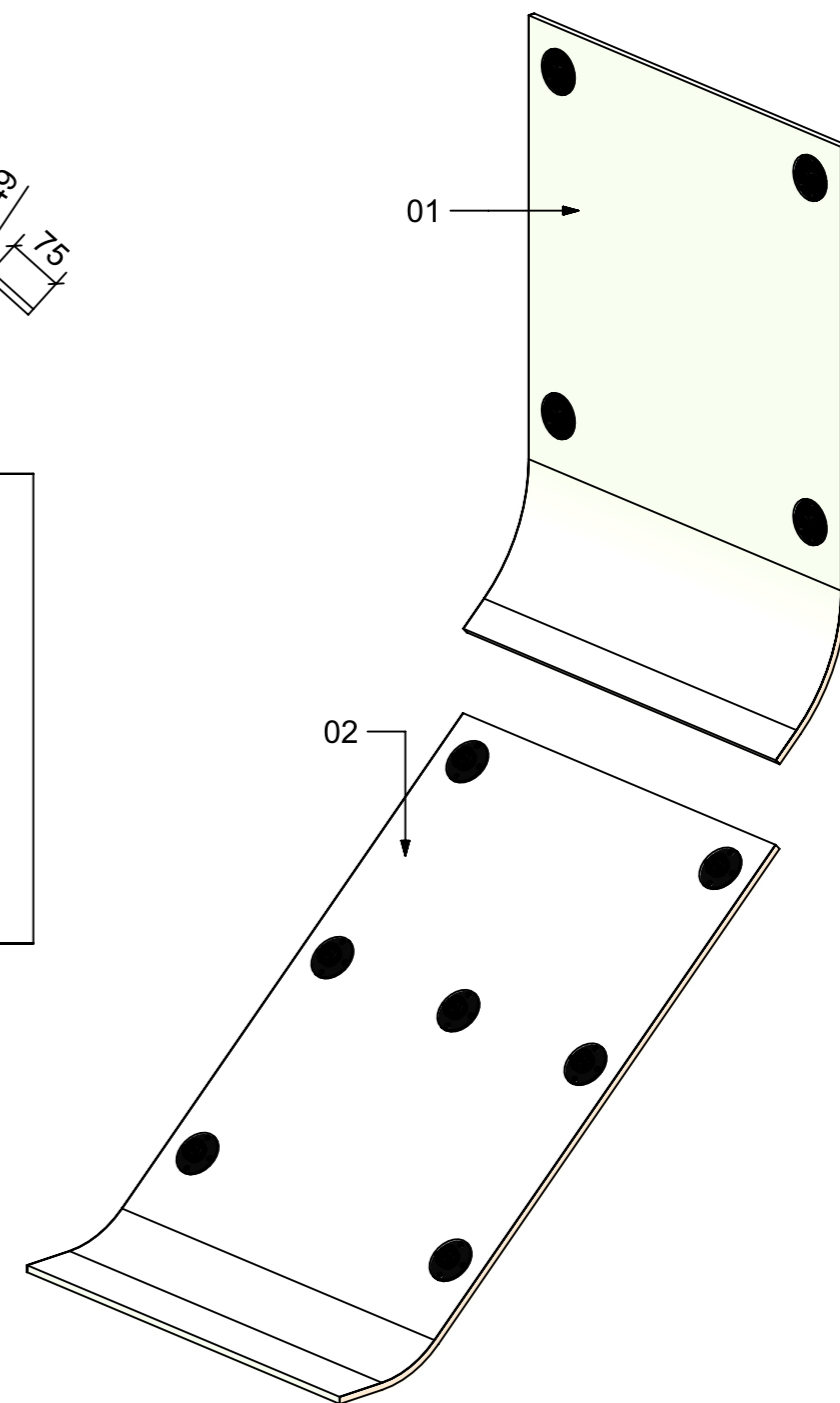
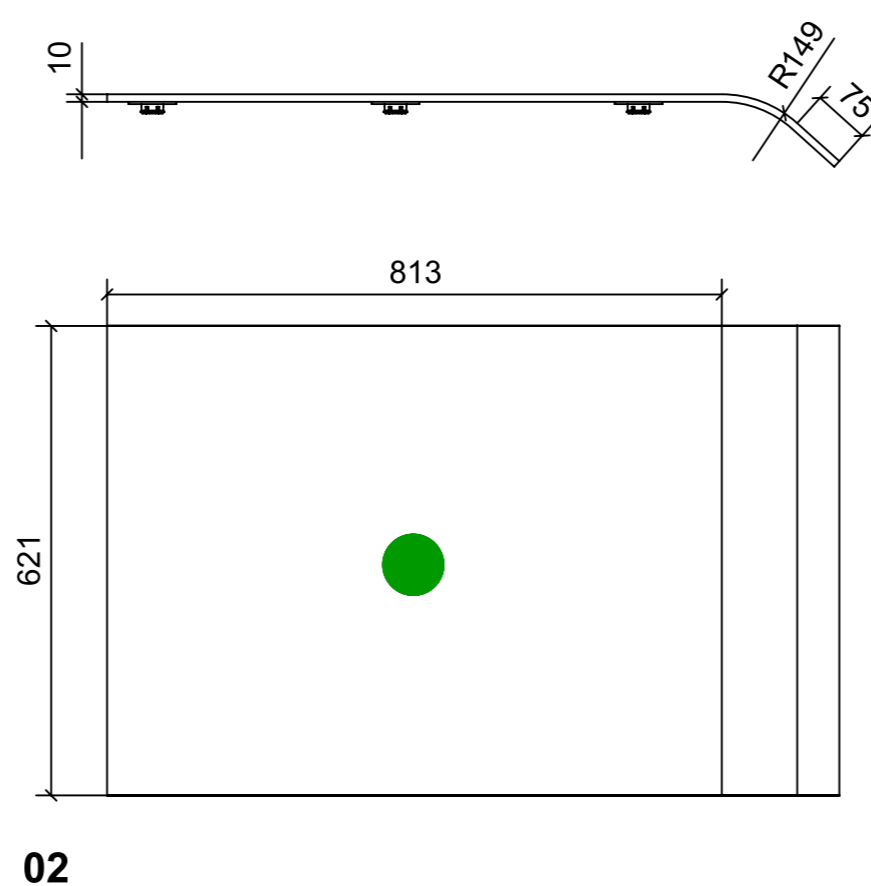
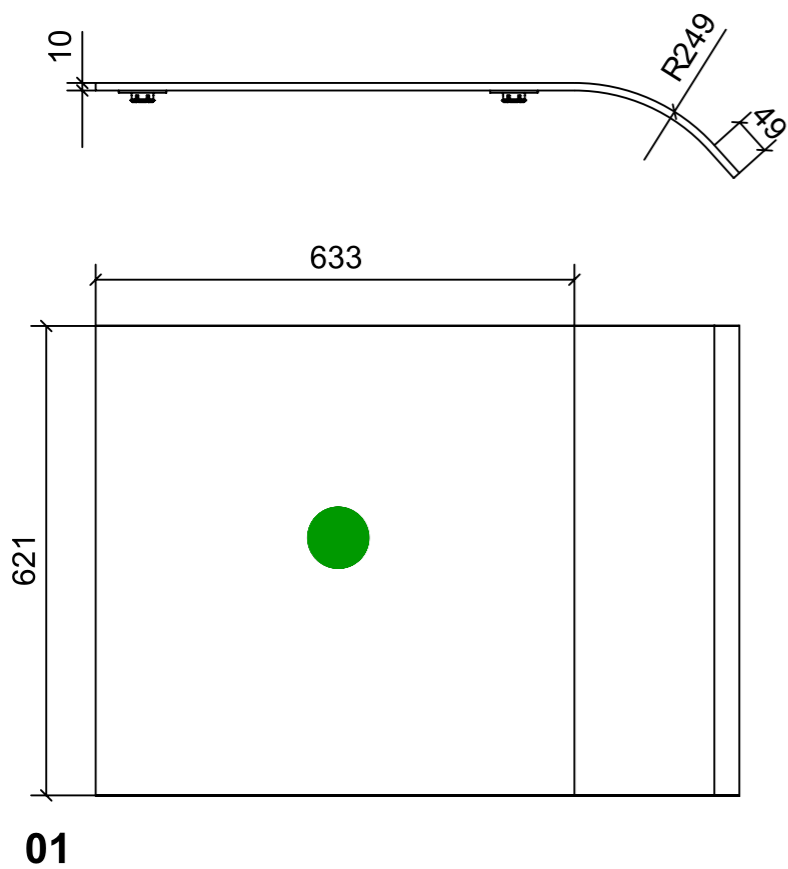

FERRAMENTA	QTY
FITLOCK M_MASCHERPA_3MM_6020202101	11

● = FILI RASATI

● = VERNICIARE 1 LATO + FILI RASATI O BORDATI

NESSUN SIMBOLO = VERNICIARE 2 LATI + FILI RASATI O BORDATI

LOCALE	CODICE	DESCRIZIONE COMPONENTE	FINITURA	GR.
LOBBY LD	MD320_L02_CN01	CIELINO DISCESA SCALE TRAVERSONAVE	LACCATO NCS- S - 1002-Y -MANOPESCA	4

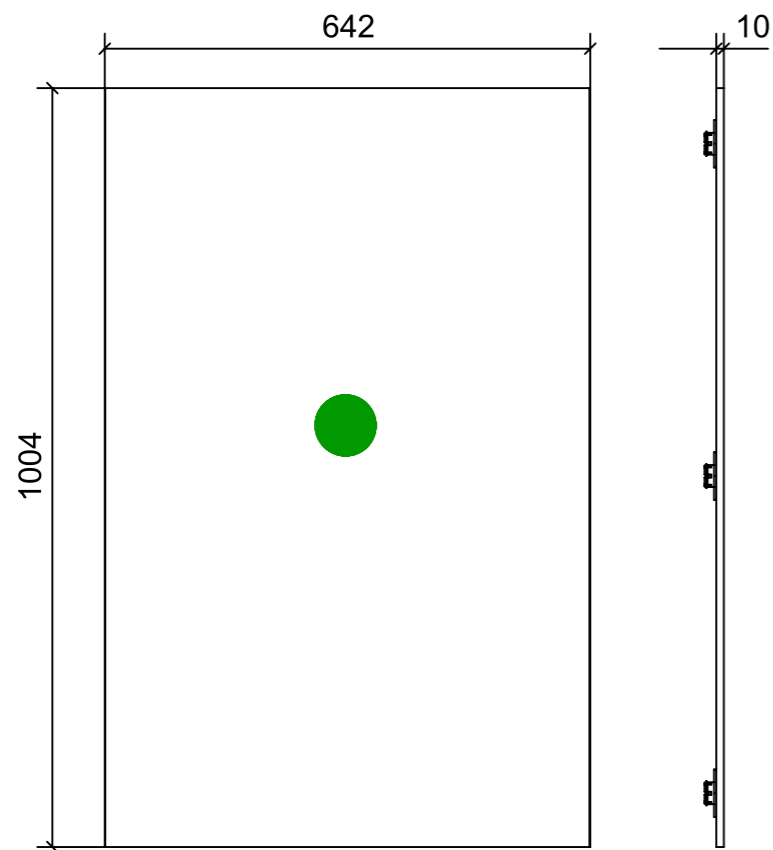

02

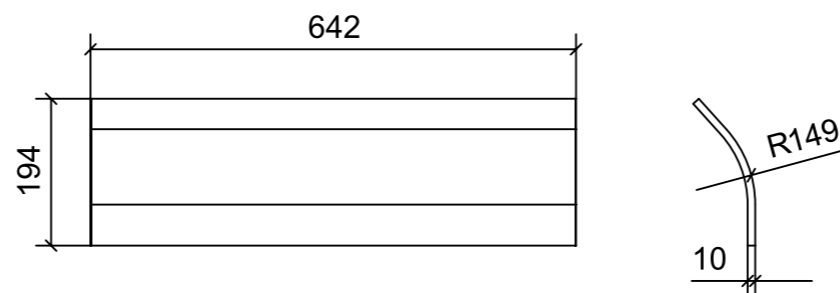

01

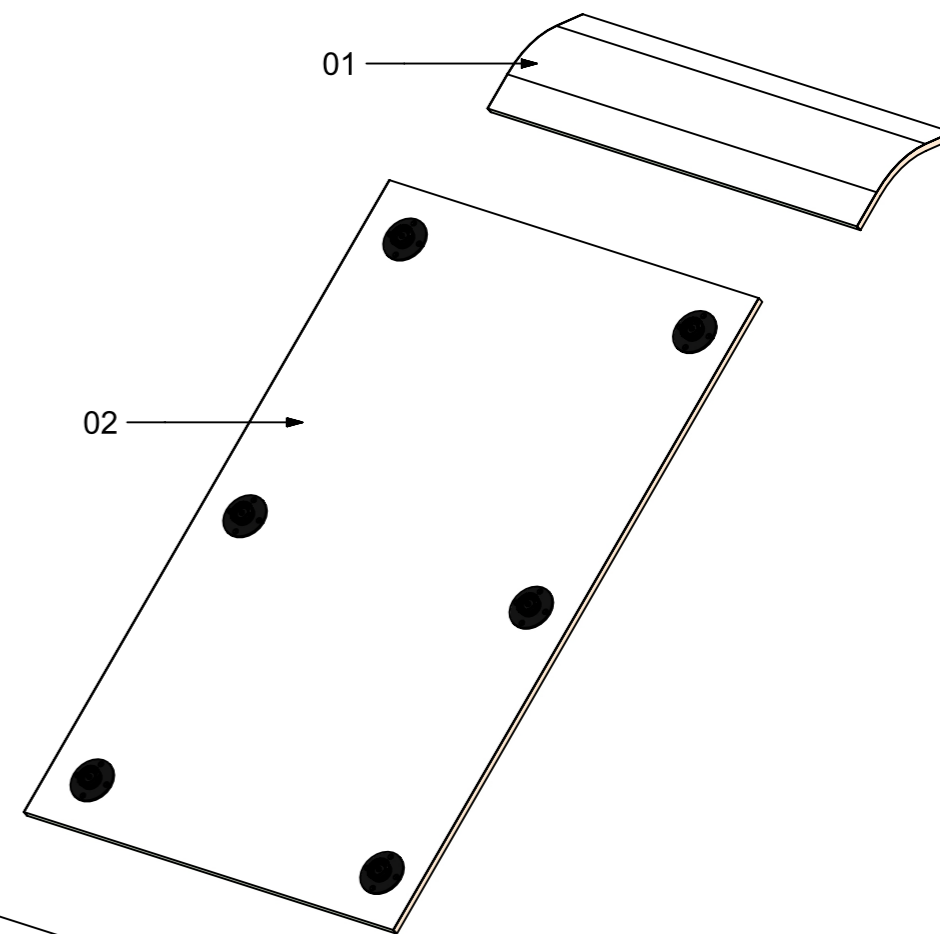

02

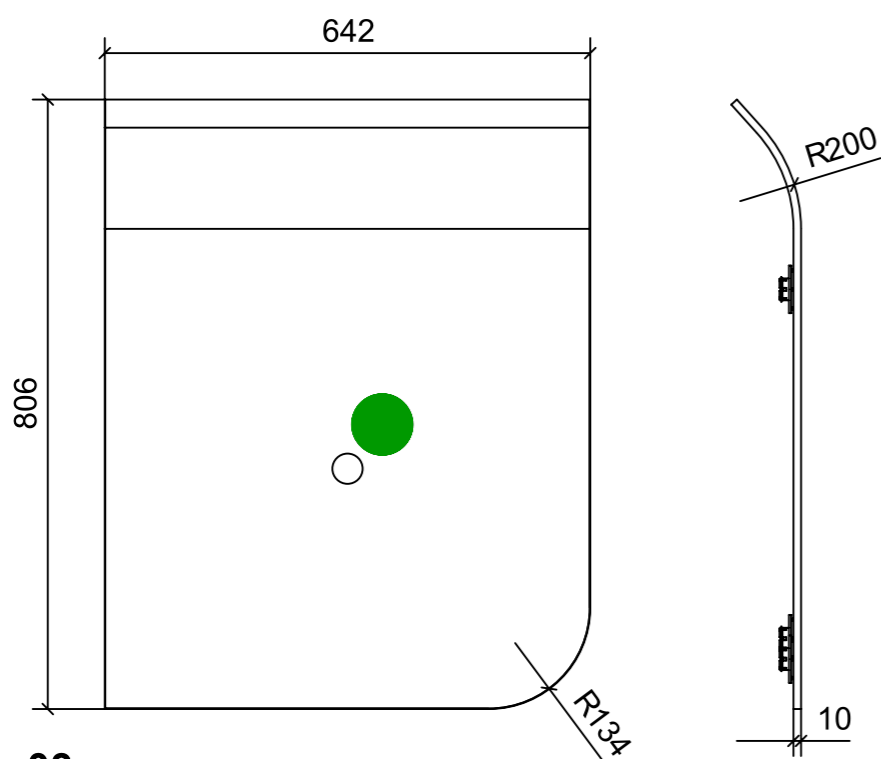

03

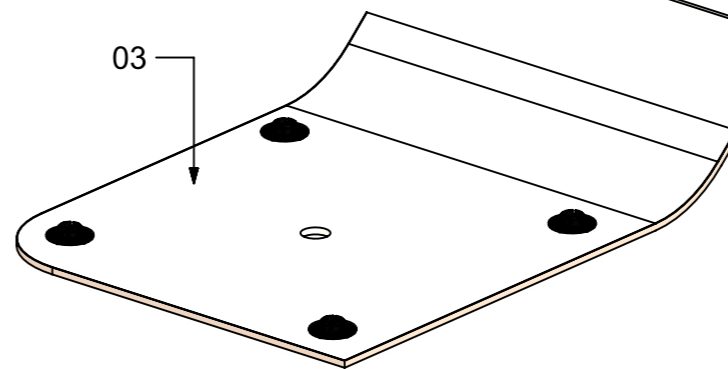

03

FERRAMENTA	QTY
FITLOCK M_MASCHERPA_3MM_6020202101	10

VERNICIATURA LASTRA/LACCATI:

● = FILI RASATI

● = VERNICIARE 1 LATO + FILI RASATI O BORDATI

NESSUN SIMBOLO = VERNICIARE 2 LATI + FILI RASATI O BORDATI