

| LOCALE        | CODICE          | DESCRIZIONE COMPONENTE         | FINITURA                  | GR |
|---------------|-----------------|--------------------------------|---------------------------|----|
| CABINA VIP SX | MD320_L01_VVA01 | STRUTTURA MURATA TESTATA LETTO | LACCATO BRONZO SPAZZOLATO | 4  |

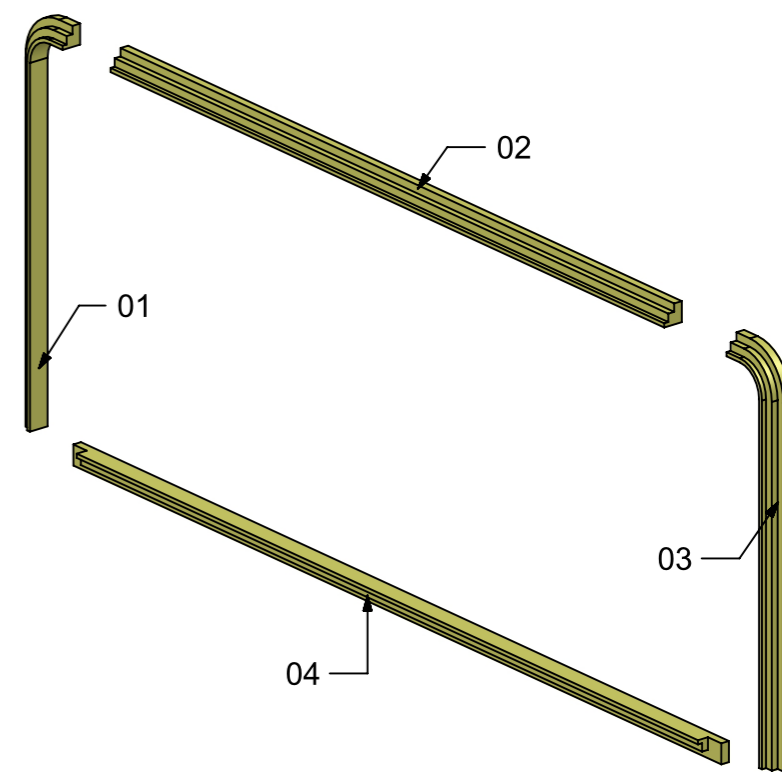

| LOCALE        | CODICE          | DESCRIZIONE COMPONENTE   | FINITURA                  | Q.TA |
|---------------|-----------------|--------------------------|---------------------------|------|
| CABINA VIP SX | MD320_L01_VVE01 | RIVESTIMENTI PARETI PRUA | LACCATO BRONZO SPAZZOLATO | 3    |

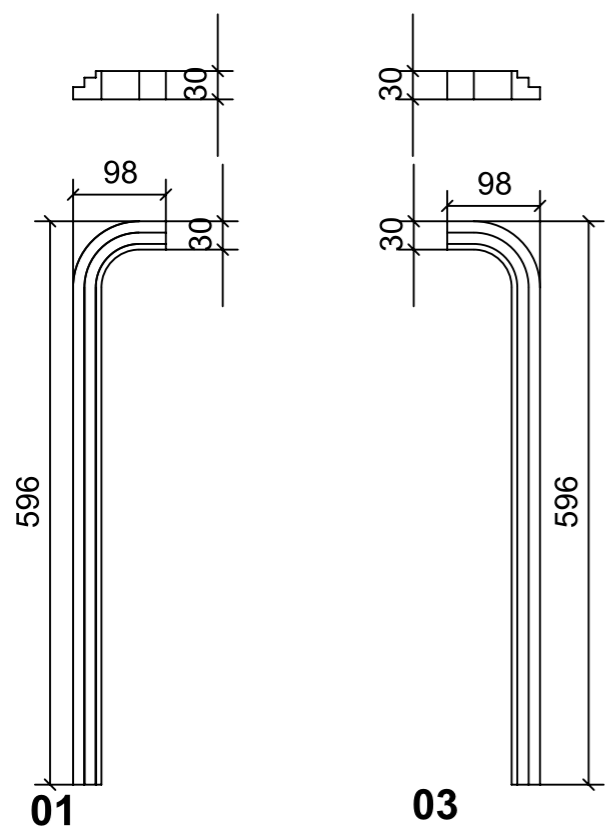
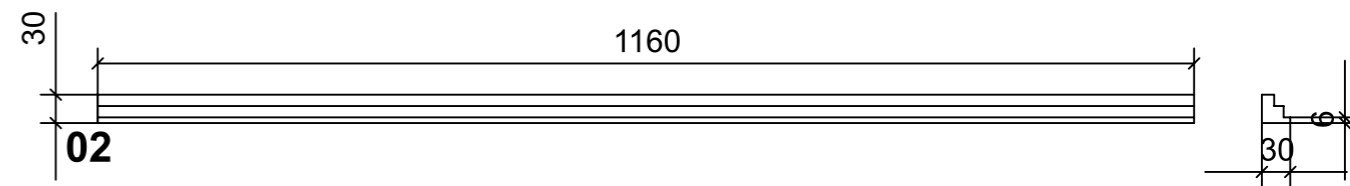
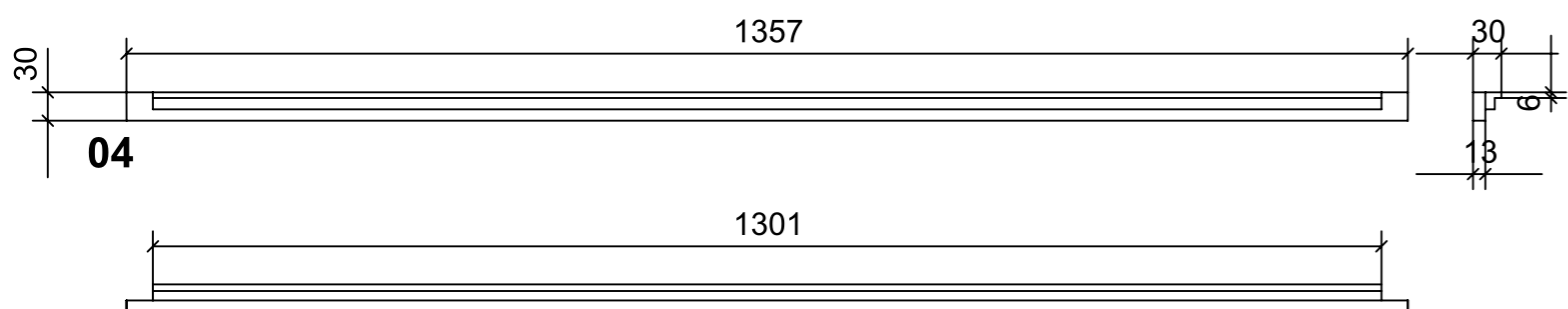
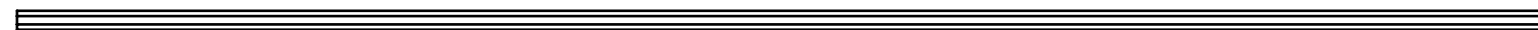

Ⓛ D

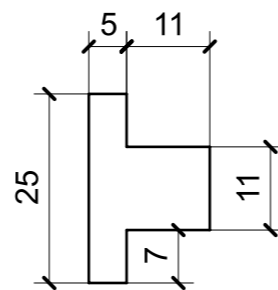

DETAIL D



VERNICIATURA LASTRA/LACCATI:

● = FILI RASATI

● = VERNICIARE 1 LATO + FILI RASATI O BORDATI

NESSUN SIMBOLO = VERNICIARE 2 LATI + FILI RASATI O BORDATI

| LOCALE        | CODICE          | DESCRIZIONE COMPONENTE    | FINITURA                  | GR |
|---------------|-----------------|---------------------------|---------------------------|----|
| CABINA VIP SX | MD320_L01_VVF01 | RIVESTIMENTI PARETI POPPA | LACCATO BRONZO SPAZZOLATO | 3  |

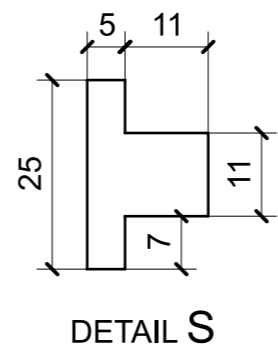
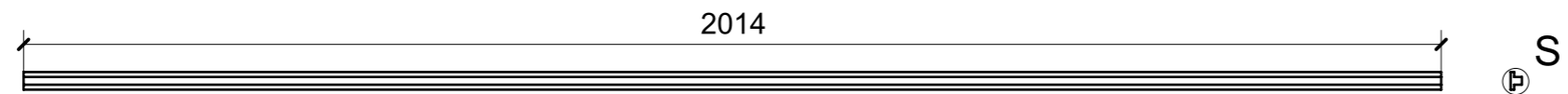

VERNICIATURA LASTRA/LACCATI: ● = FILI RASATI

● = VERNICIARE 1 LATO + FILI RASATI O BORDATI

NESSUN SIMBOLO = VERNICIARE 2 LATI + FILI RASATI O BORDATI

| LOCALE        | CODICE          | DESCRIZIONE COMPONENTE          | FINITURA                  | GR |
|---------------|-----------------|---------------------------------|---------------------------|----|
| CABINA VIP SX | MD320_L01_VVG01 | RIVESTIMENTI PARETI CENTRO NAVE | LACCATO BRONZO SPAZZOLATO | 3  |

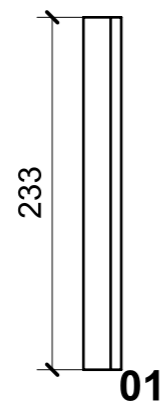

G

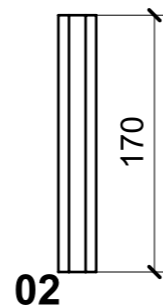

H

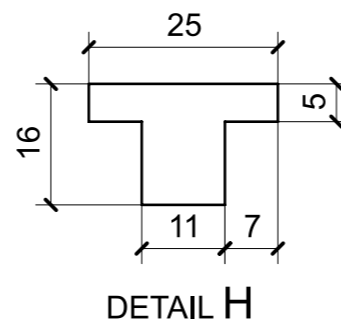
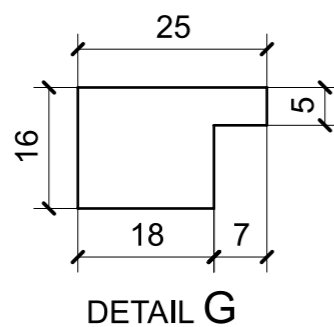
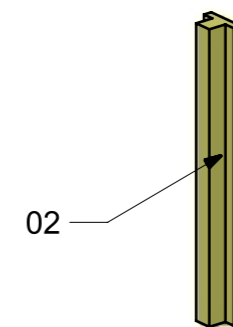
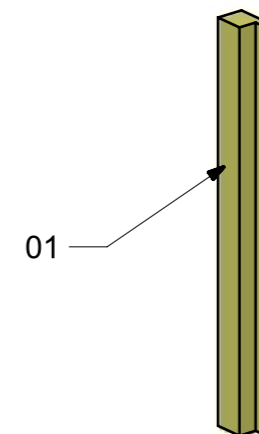

VERNICIATURA LASTRA/LACCATI:

● = FILI RASATI

● = VERNICIARE 1 LATO + FILI RASATI O BORDATI

NESSUN SIMBOLO = VERNICIARE 2 LATI + FILI RASATI O BORDATI

| LOCALE        | CODICE          | DESCRIZIONE COMPONENTE | FINITURA                           | GR |
|---------------|-----------------|------------------------|------------------------------------|----|
| CABINA VIP SX | MD320_L02_VVO01 | CIELINO                | LACCATO NCS- S - 1002-Y -MANOPESCA | 4  |

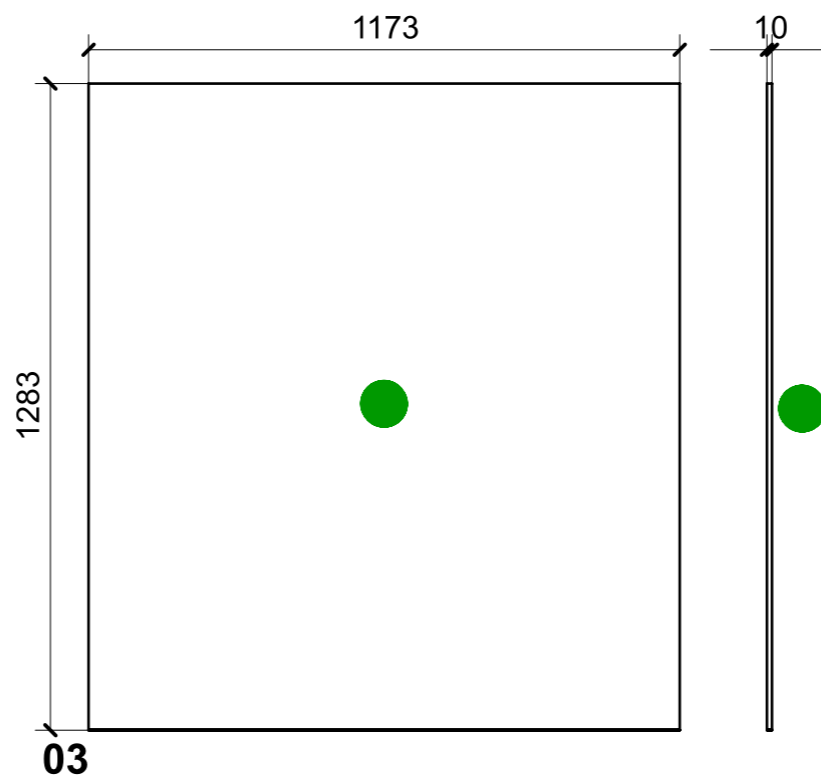
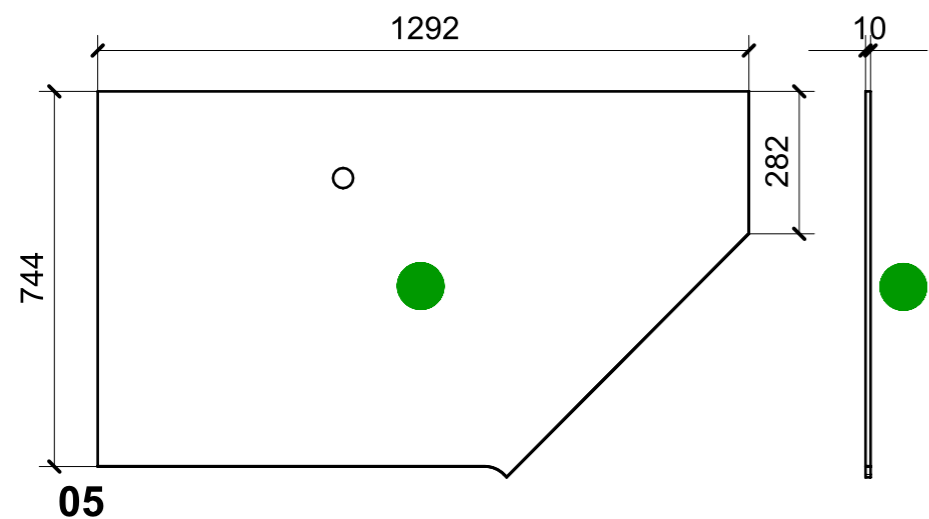
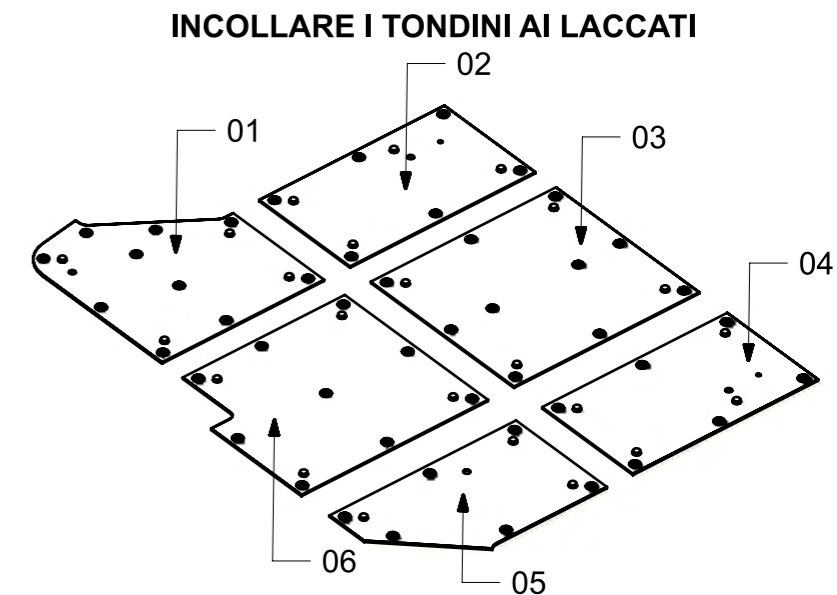
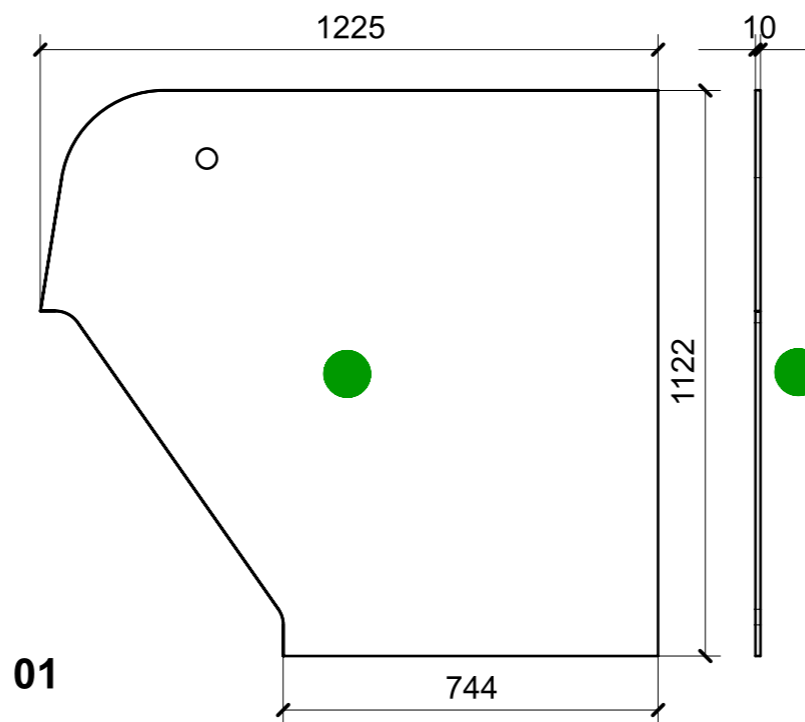
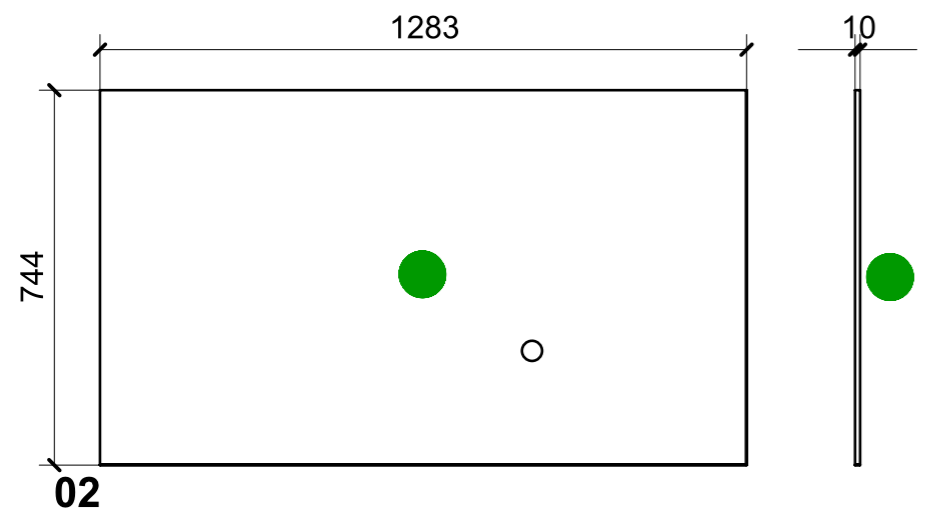

| FERRAMENTA                              | QTY |
|---|-----|
| TONDINO PER CENTRAGGIO ANTICADUTA 40X15 | 23  |
| FITLOCK M_MASCHERPA_3MM_6020202101      | 47  |

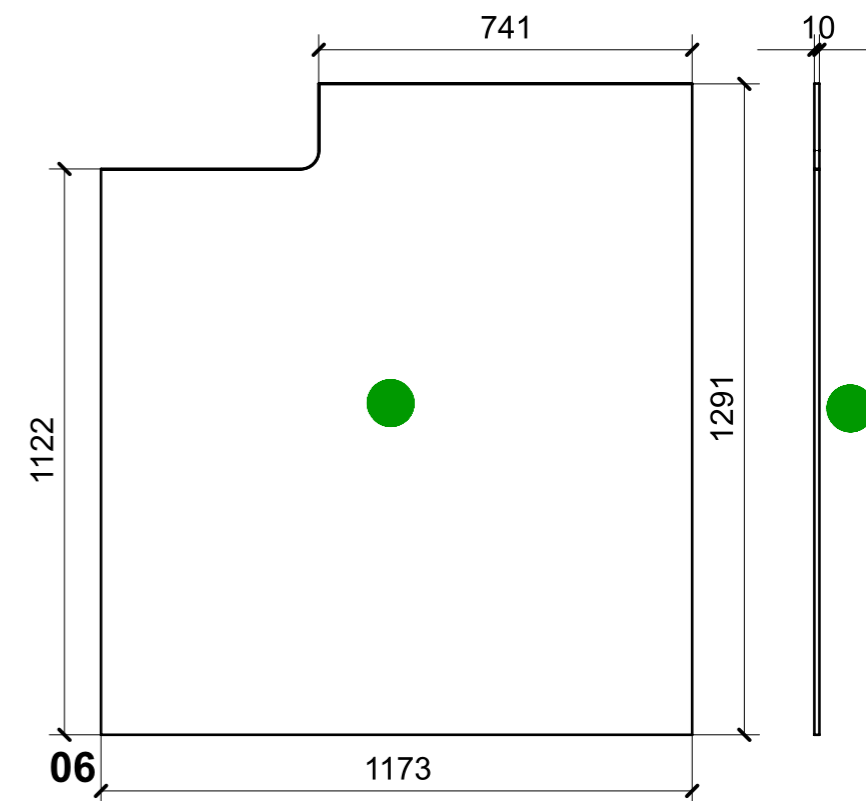
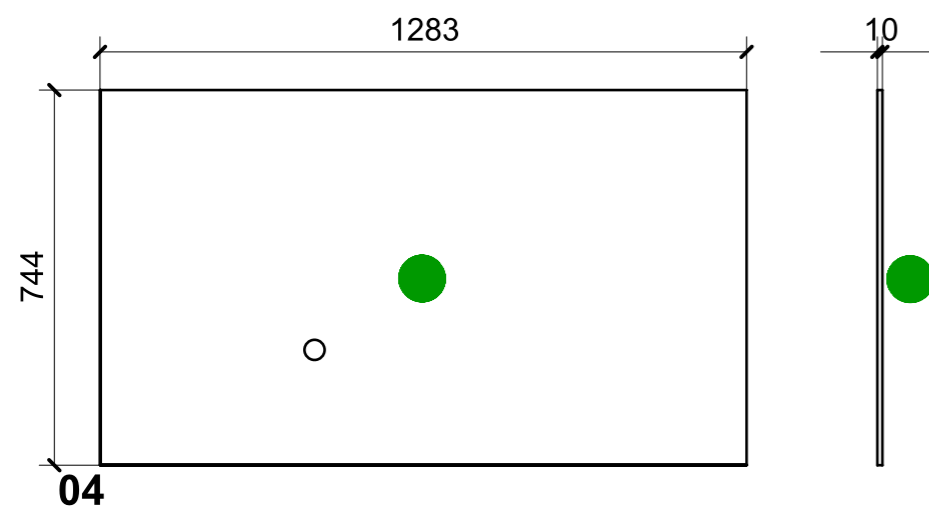

VERNICIATURA LASTRA/LACCATI: ● = VERNICIARE 1 LATO + FILI RASATI O BORDATI

NESSUN SIMBOLO = VERNICIARE 2 LATI + FILI RASATI O BORDATI