

LOCALE	CODICE	DESCRIZIONE COMPONENTE	FINITURA	GR.
CABINA VIP	MD320_L01_VA01	STRUTTURA MURATA TESTATA LETTO	LACCATO BRONZO SPAZZOLATO	4

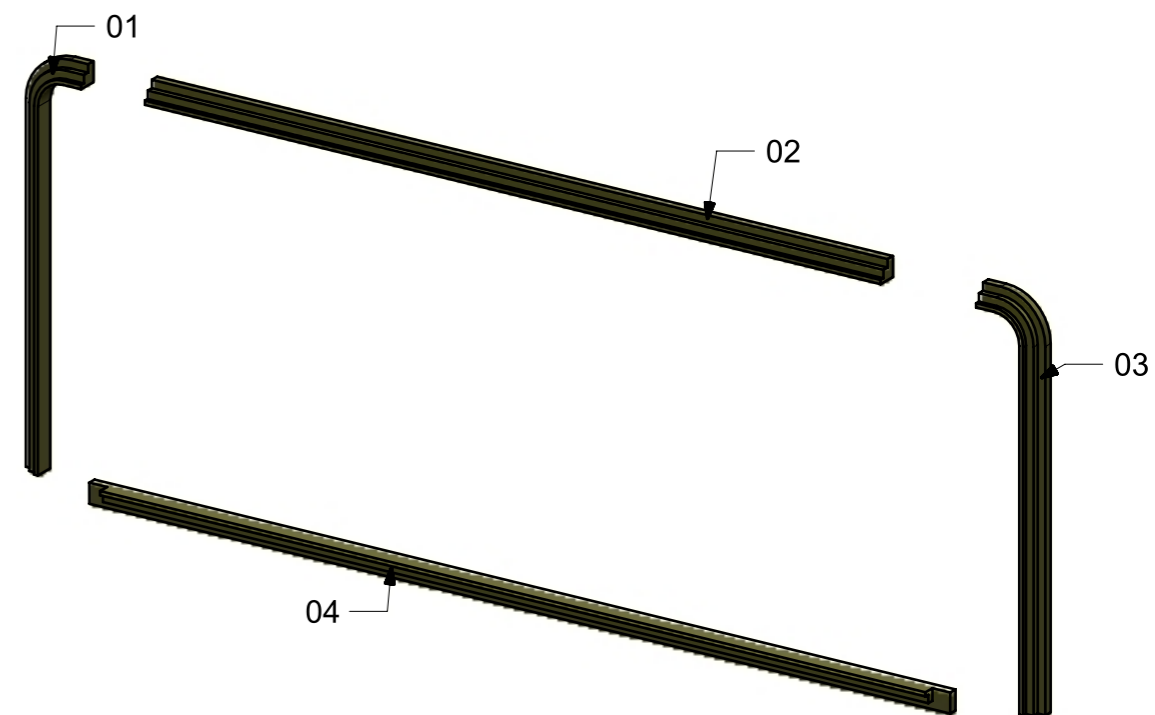

LOCALE	CODICE	DESCRIZIONE COMPONENTE	FINITURA	GR.
CABINA VIP	MD320_L01_VE01	RIVESTIMENTI PARETI PRUA	LACCATO BRONZO	3

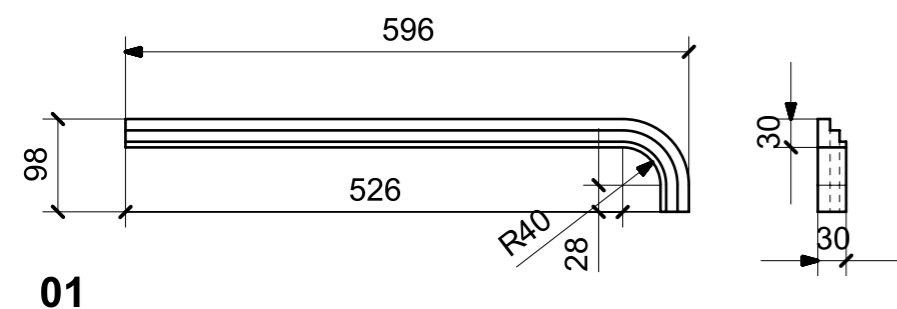
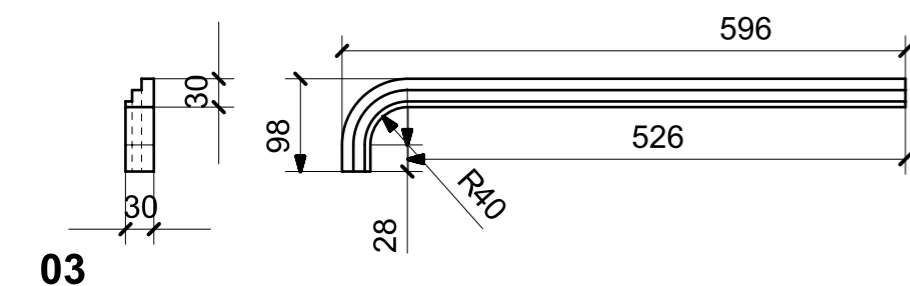
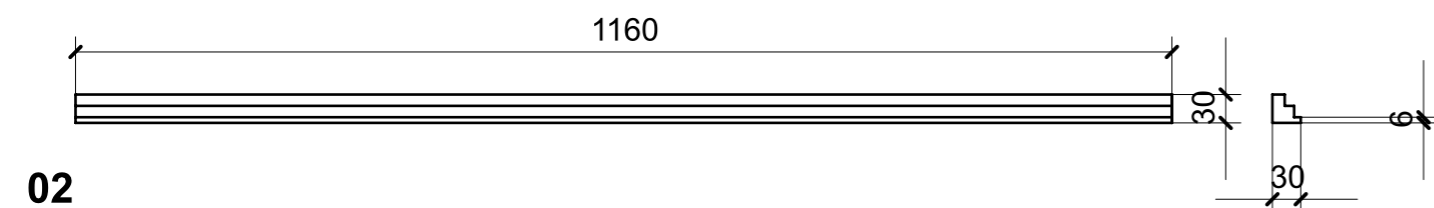
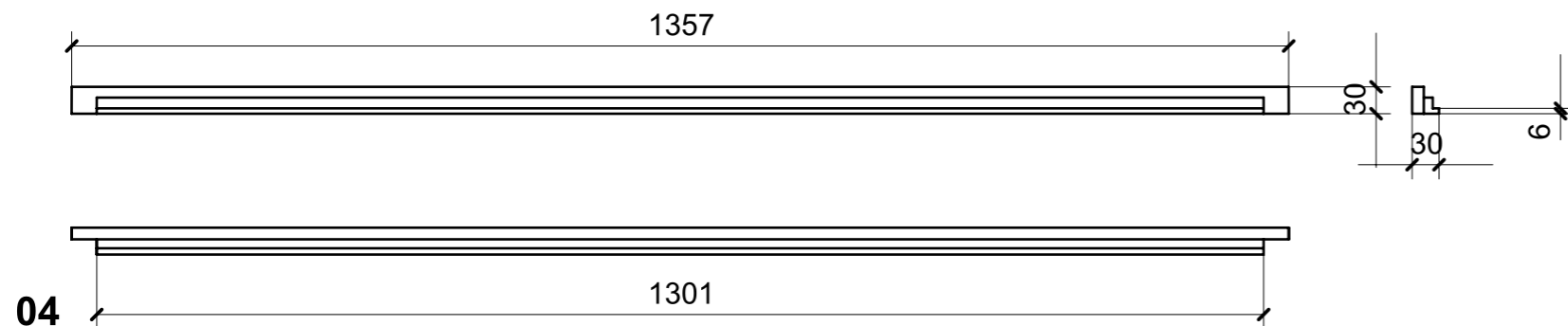

D

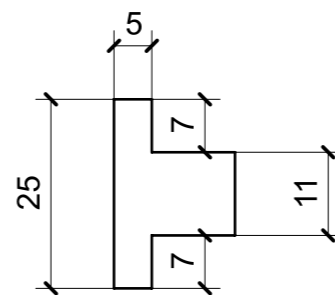

DETAIL D



LOCALE	CODICE	DESCRIZIONE COMPONENTE	FINITURA	GR.
CABINA VIP	MD320_L01_VF01	RIVESTIMENTI PARETI POPPA	LACCATO BRONZO SPAZZOLATO	2

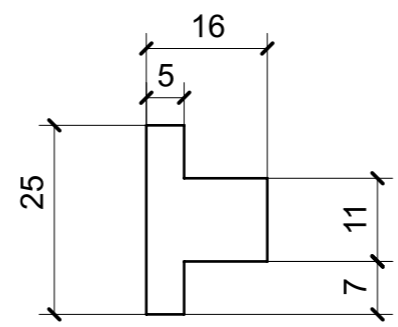
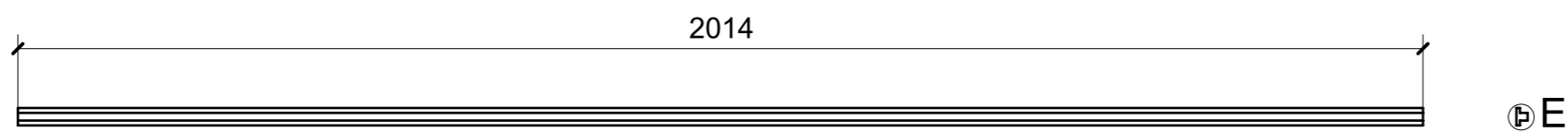

DETAIL E



LOCALE	CODICE	DESCRIZIONE COMPONENTE	FINITURA	GR.
CABINA VIP	MD320_L01_VG01	RIVESTIMENTI PARETI CENTRO NAVE	LACCATO BRONZO SPAZZOLATO	3

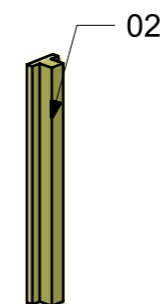
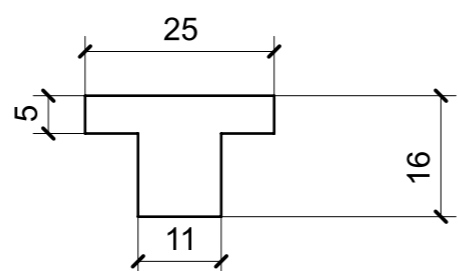
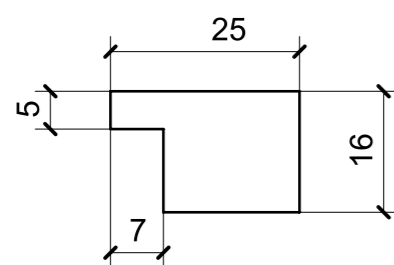
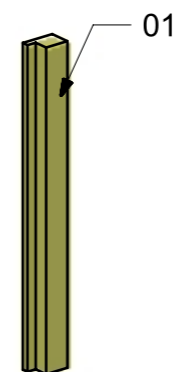
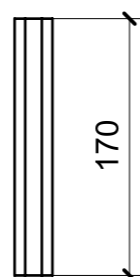
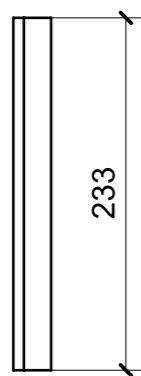

DETAIL F

DETAIL G

01

02

LOCALE	CODICE	DESCRIZIONE COMPONENTE	FINITURA	GR.
CABINA VIP	MD320_L02_VO01	CIELINO	LACCATO NCS- S - 1002-Y -MANOPESCA	4

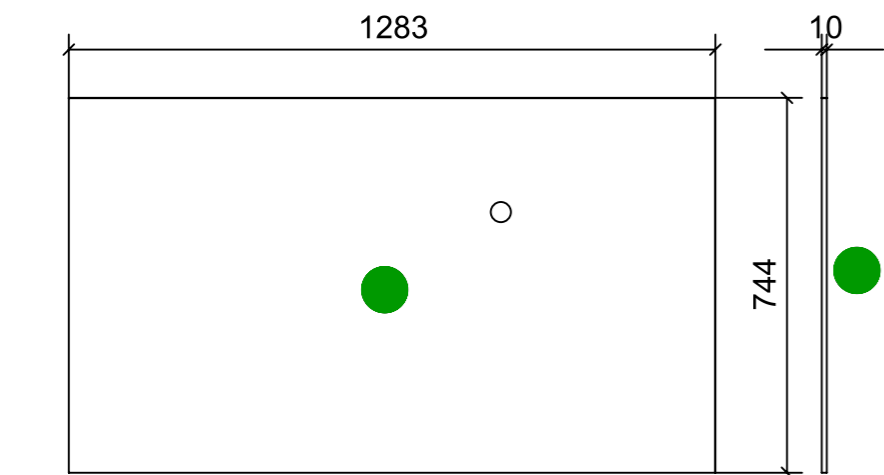

01

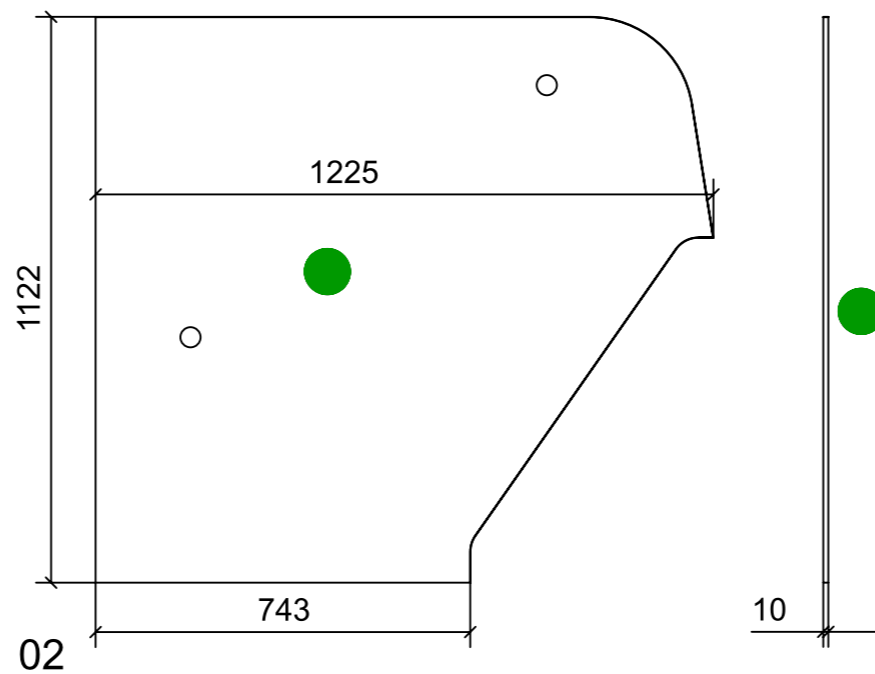

02

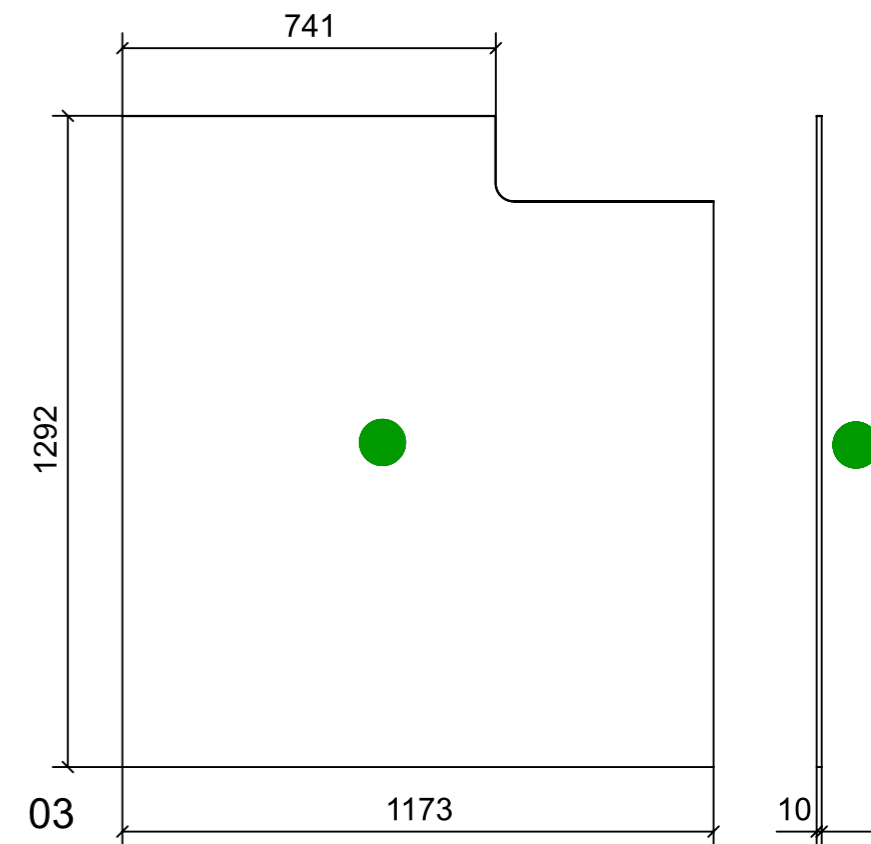

03

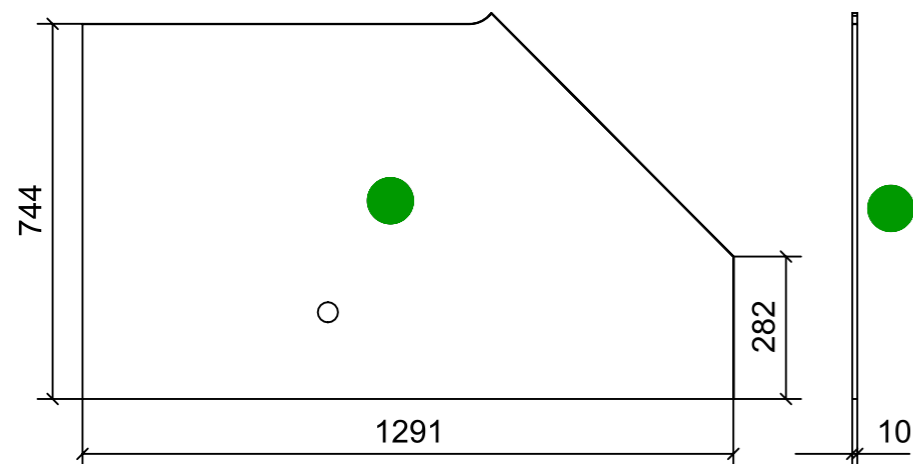

04

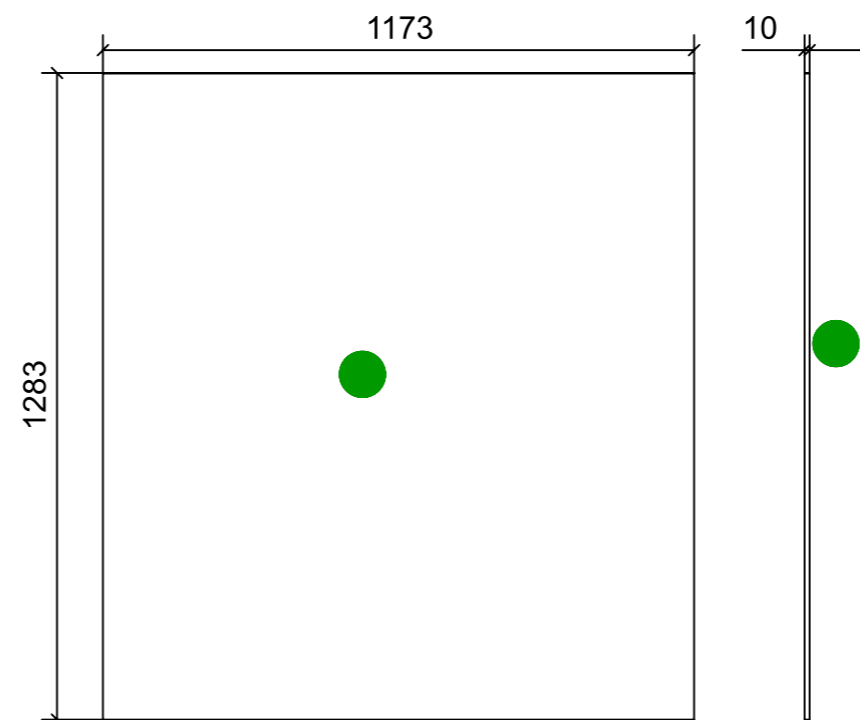

06

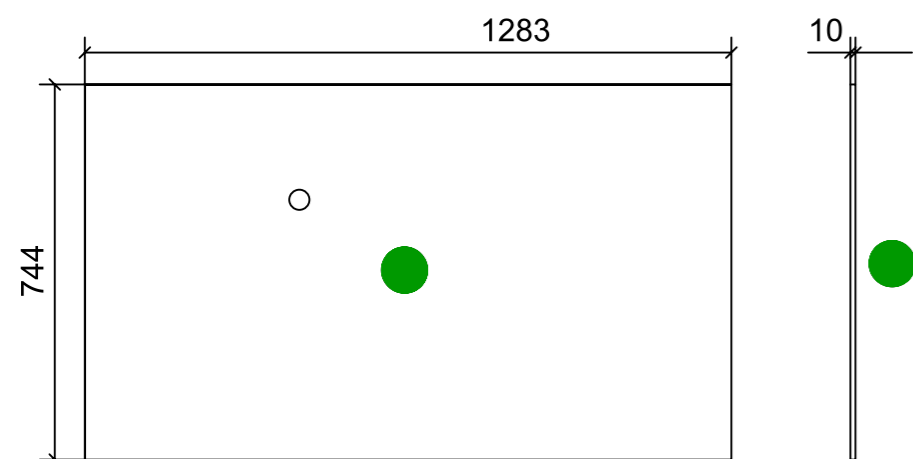

05

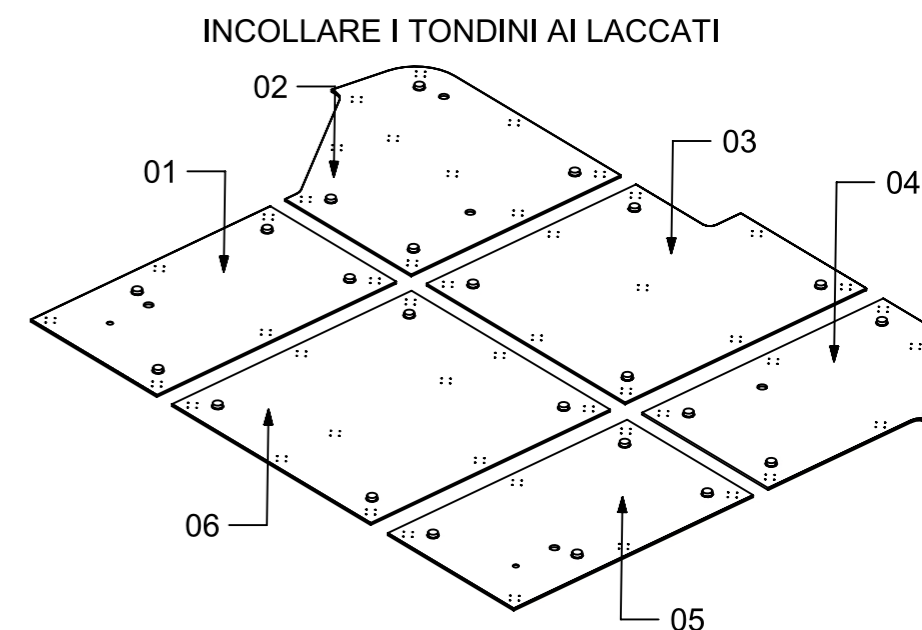

FERRAMENTA	QTY
TONDINO PER CENTRAGGIO ANTICADUTA 40X15	23

VERNICIATURA LASTRA/LACCATI:

● = VERNICIARE 1 LATO + FILI RASATI O BORDATI

NESSUN SIMBOLO = VERNICIARE 2 LATI + FILI RASATI O BORDATI