

LOCALE	CODICE	DESCRIZIONE COMPONENTE	FINITURA	GR.
BAGNO OSPITI SX	MD320_L02_YE01	CIELINO INGRESSO	LACCATO NCS- S - 1002-Y -MANOPESCA	4

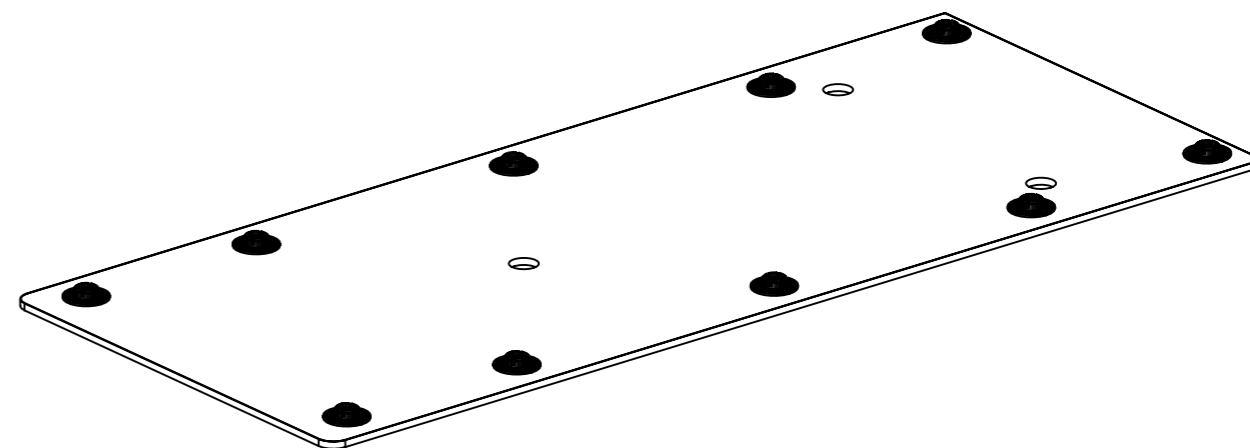
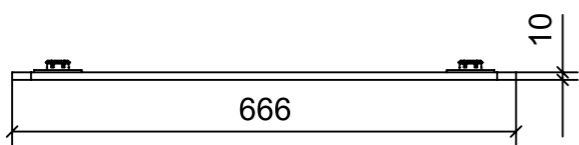
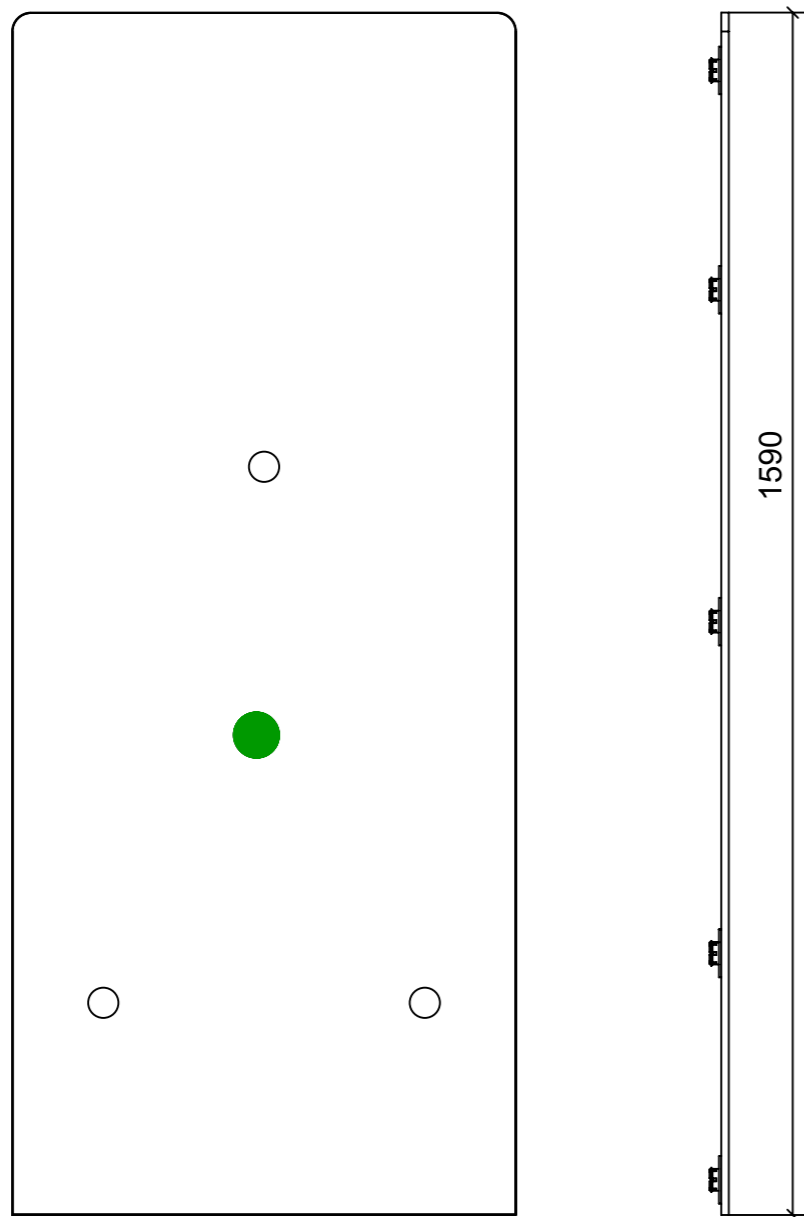

FERRAMENTA	QTY
FITLOCK M_MASCHERPA_3MM_6020202101	10

VERNICIATURA LASTRA/LACCATI:

● = FILI RASATI

● = VERNICIARE 1 LATO + FILI RASATI O BORDATI

NESSUN SIMBOLO = VERNICIARE 2 LATI + FILI RASATI O BORDATI

LOCALE	CODICE	DESCRIZIONE COMPONENTE	FINITURA	GR.
BAGNO OSPITI SX	MD320_L02_YH01	RIVESTIMENTI ZONA DOCCIA	LACCATO NCS- S - 1002-Y -MANOPESCA	2

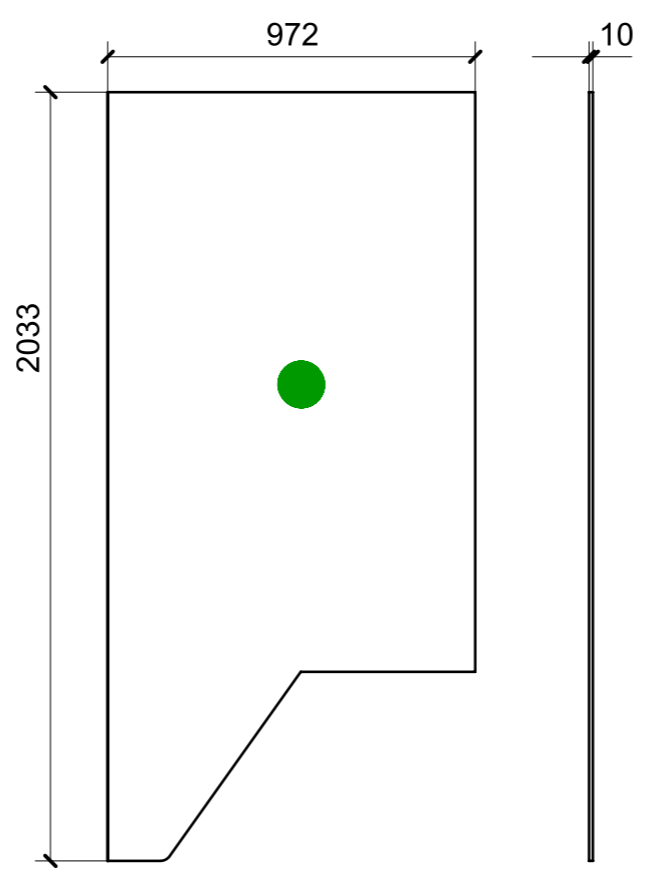
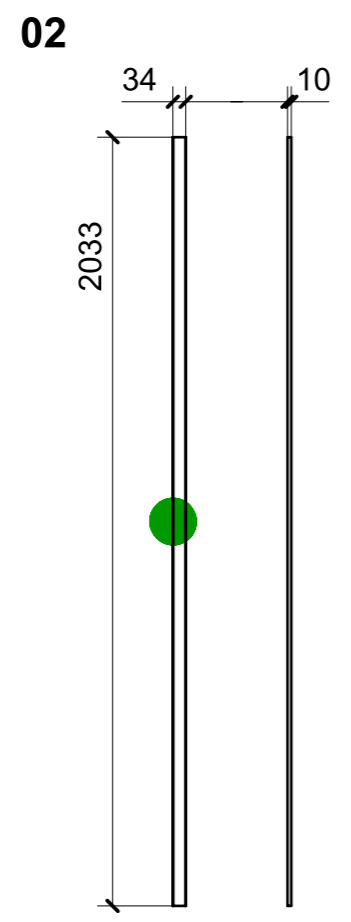
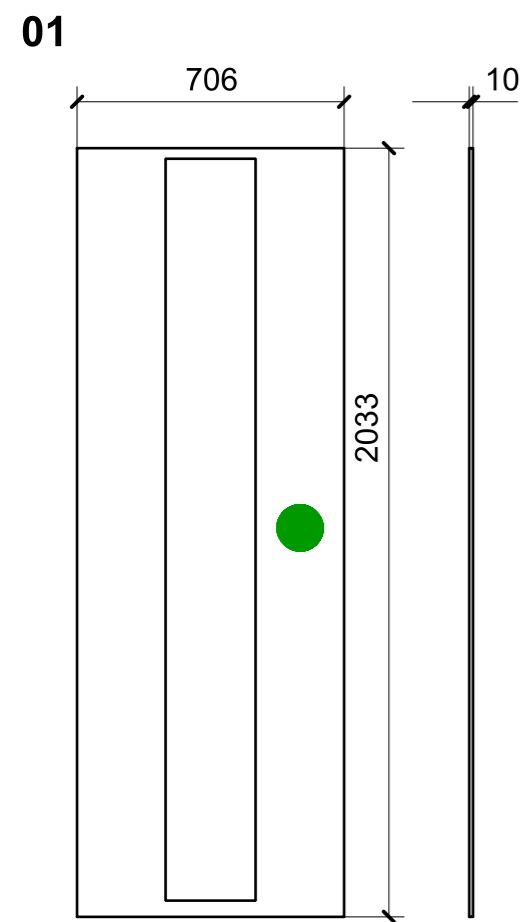
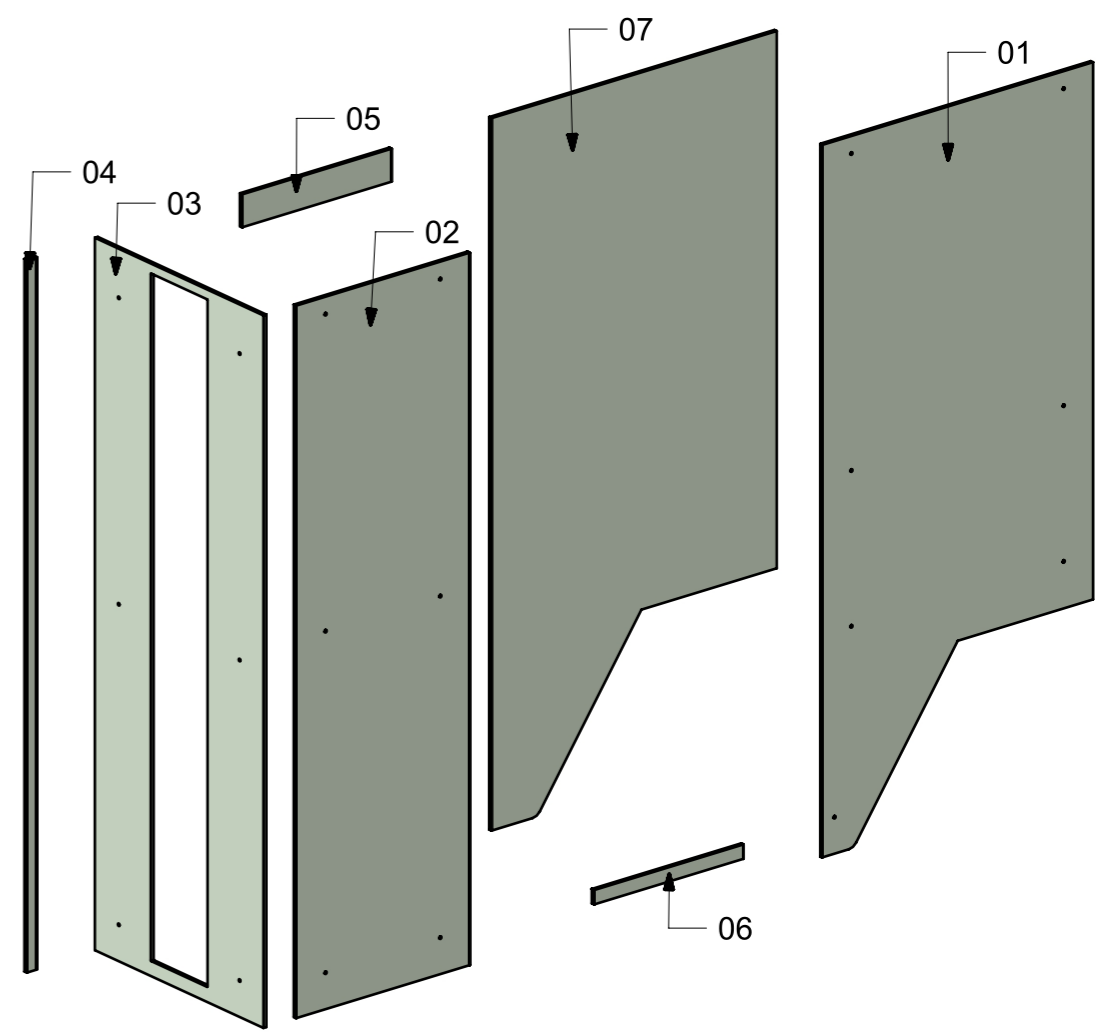
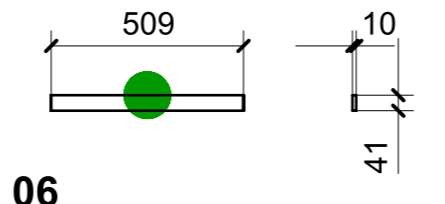
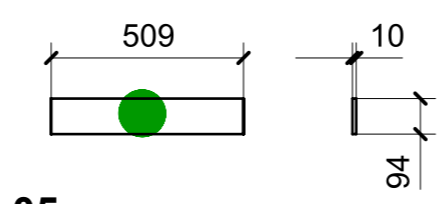
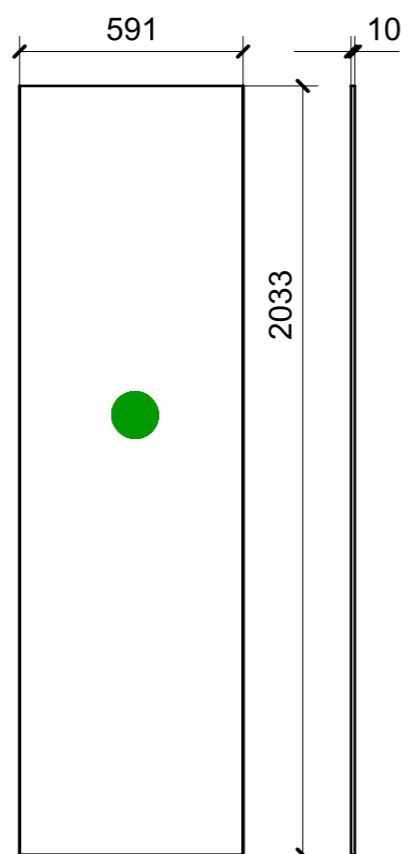
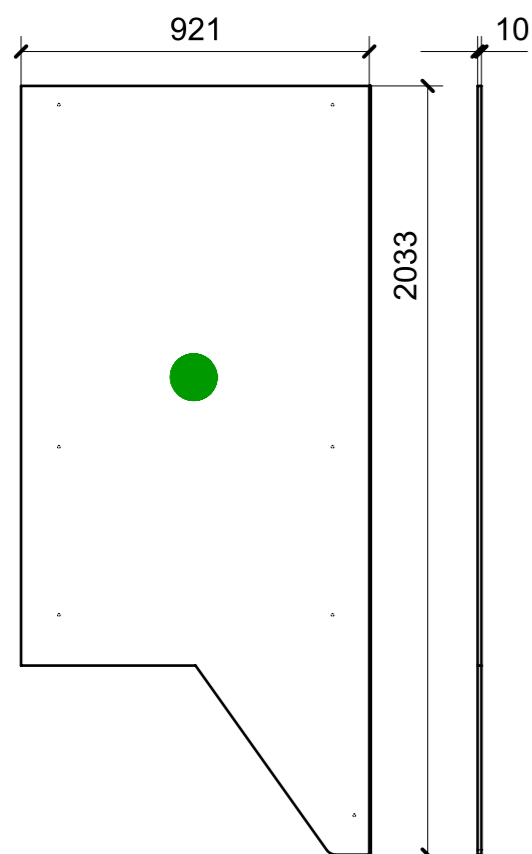

03

04

07

● = FILI RASATI

● = VERNICIARE 1 LATO + FILI RASATI O BORDATI

NESSUN SIMBOLO = VERNICIARE 2 LATI + FILI RASATI O BORDATI

LOCALE	CODICE	DESCRIZIONE COMPONENTE	FINITURA	GR.
BAGNO OSPITI SX	MD320_L02_YI01	STRUTTURA MURATA DOCCIA	LACCATO NCS- S - 1002-Y -MANOPESCA	2

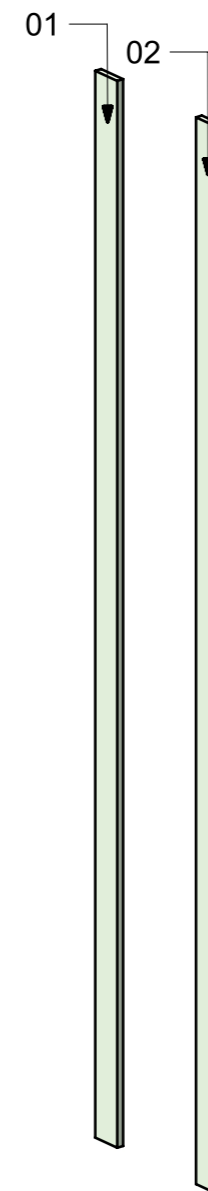
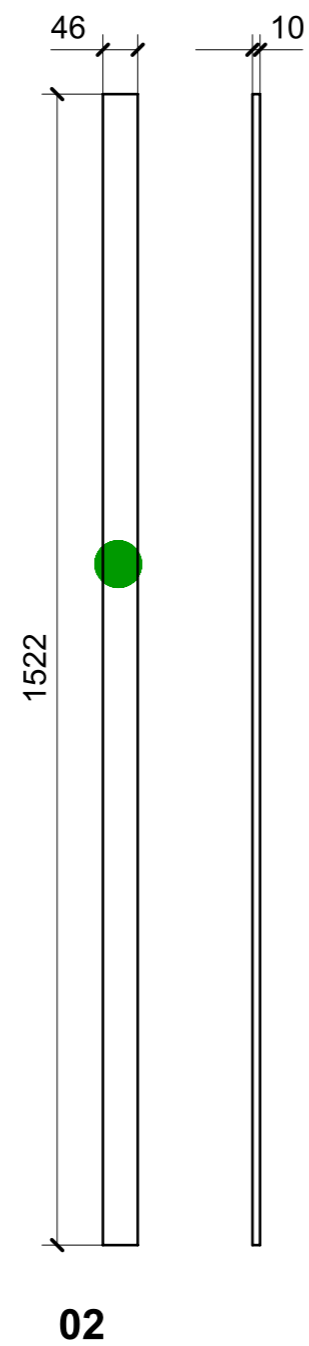
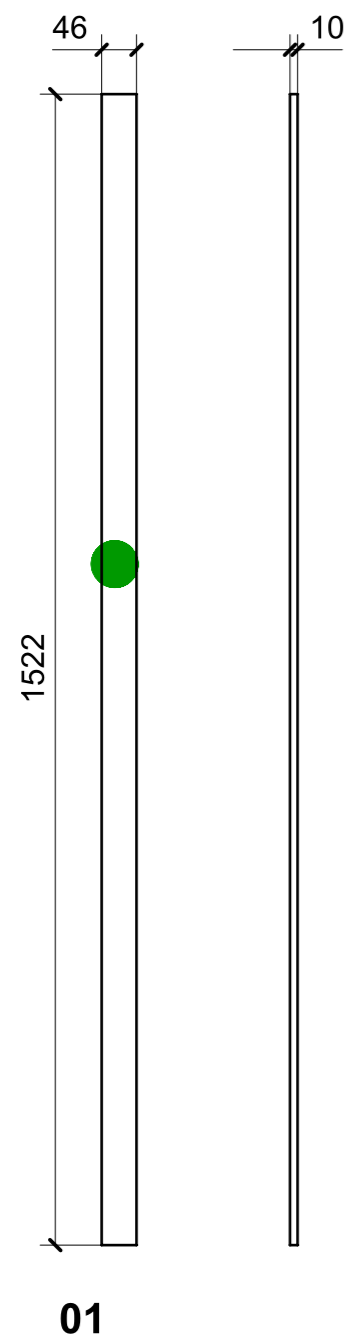

VERNICIATURA LASTRA/LACCATI:

● = FILI RASATI

● = VERNICIARE 1 LATO + FILI RASATI O BORDATI

NESSUN SIMBOLO = VERNICIARE 2 LATI + FILI RASATI O BORDATI

LOCALE	CODICE	DESCRIZIONE COMPONENTE	FINITURA	GR.
BAGNO OSPITI SX	MD320_L02_YL01	RIV. SOTTO SEDUTA DOCCIA	LACCATO NCS- S - 1002-Y -MANOPESCA	2

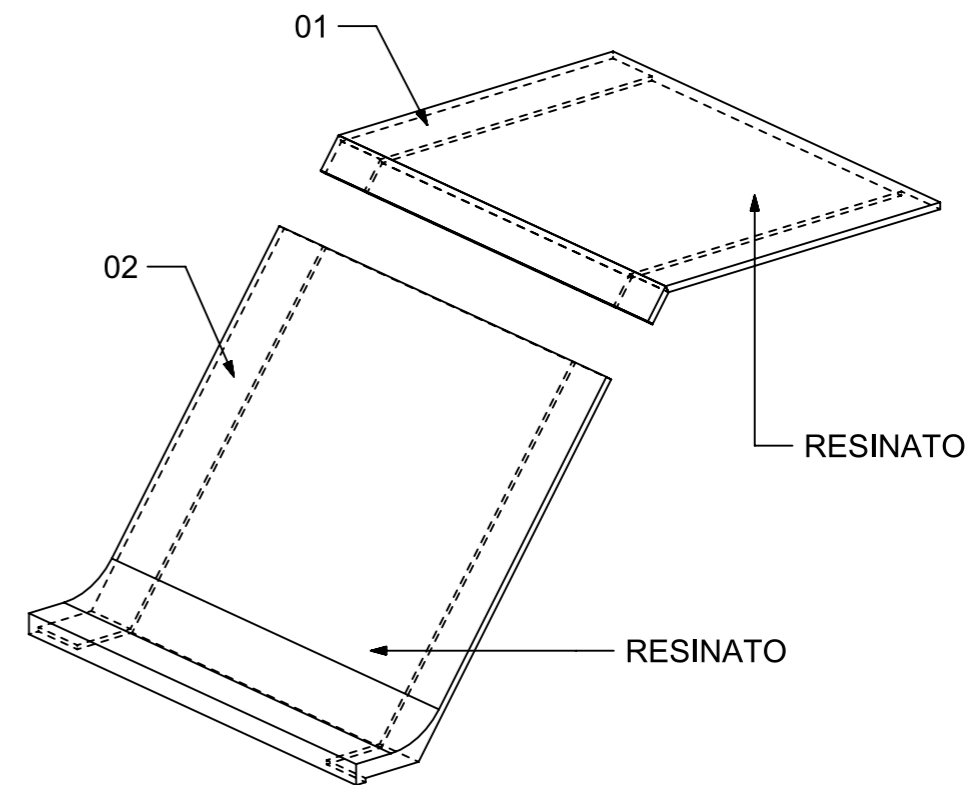
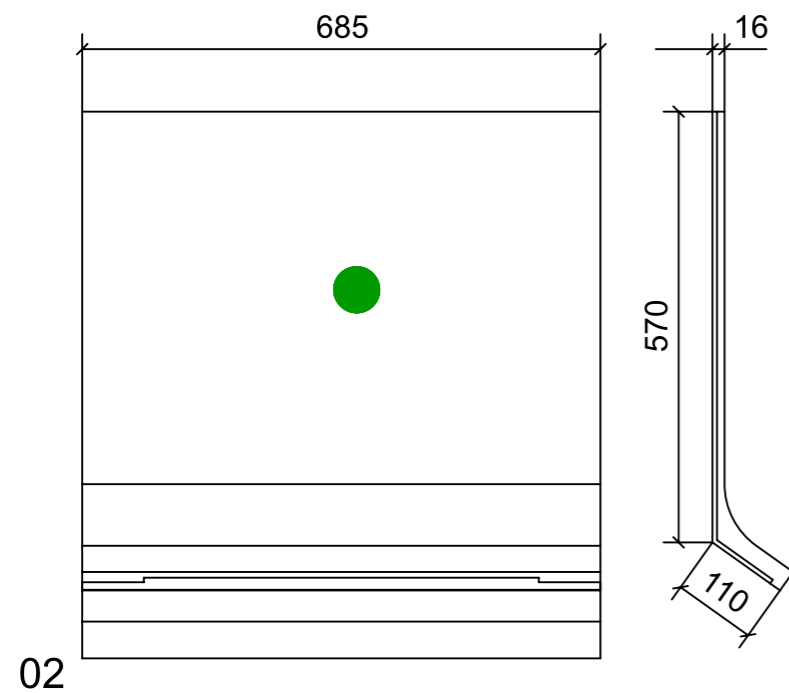
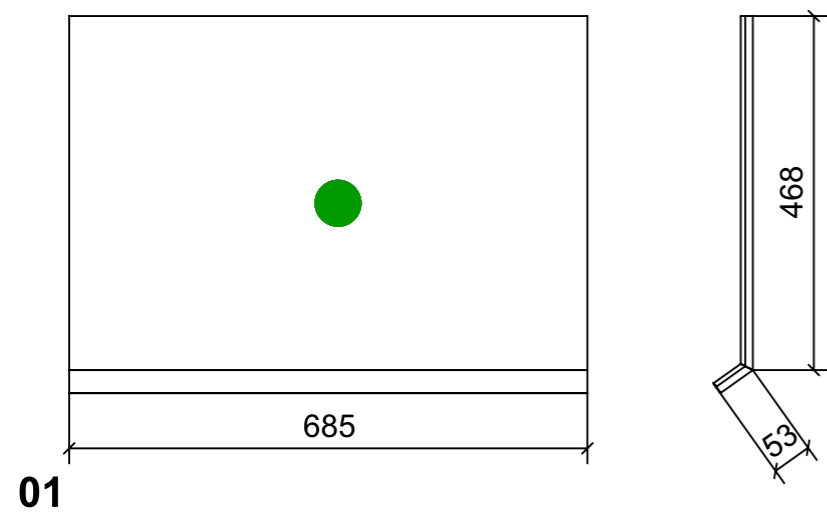

VERNICIATURA LASTRA/LACCATI:

● = FILI RASATI

● = VERNICIARE 1 LATO + FILI RASATI O BORDATI

NESSUN SIMBOLO = VERNICIARE 2 LATI + FILI RASATI O BORDATI

LOCALE	CODICE	DESCRIZIONE COMPONENTE	FINITURA	GR.
BAGNO OSPITI SX	MD320_L02_YO01	CIELINO ZONA DOCCIA	LACCATO NCS- S - 1002-Y -MANOPESCA	4

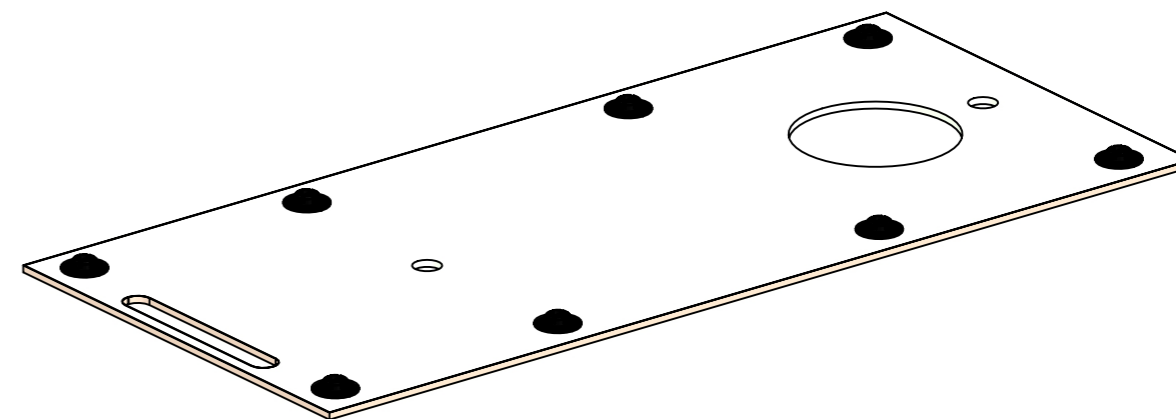
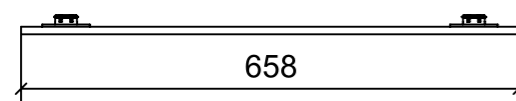
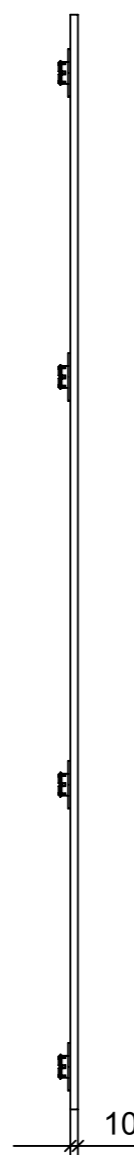
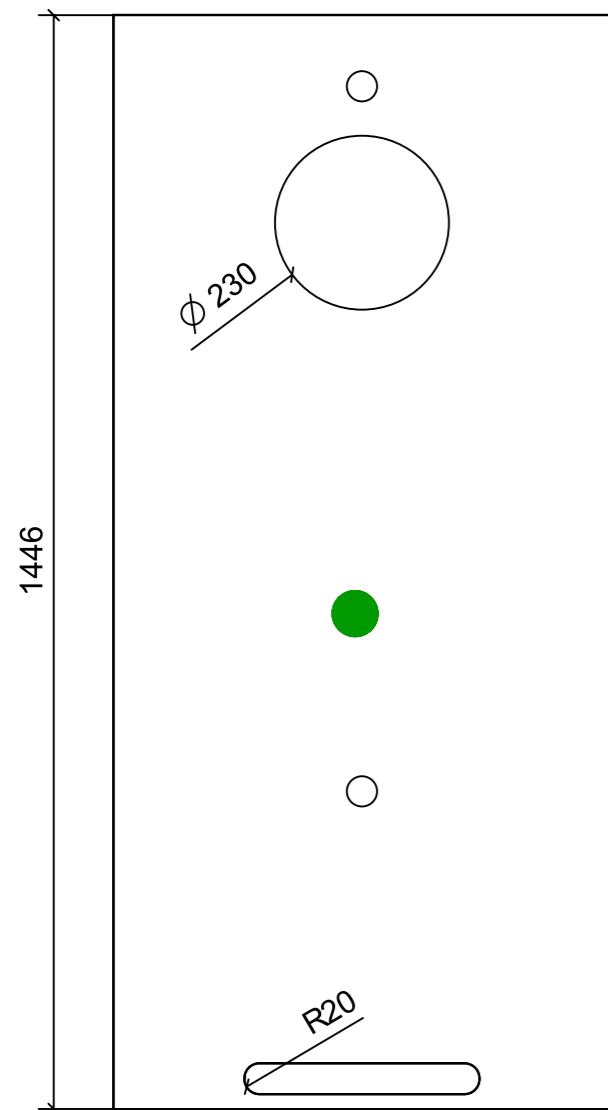

FERRAMENTA	QTY
FITLOCK M_MASCHERPA_3MM_6020202101	8

VERNICIATURA LASTRA/LACCATI:

● = FILI RASATI

● = VERNICIARE 1 LATO + FILI RASATI O BORDATI

NESSUN SIMBOLO = VERNICIARE 2 LATI + FILI RASATI O BORDATI