

LOCALE	CODICE	DESCRIZIONE COMPONENTE	FINITURA	GR.
BAGNO VIP DX	MD320_MG_JA01	STRUTTURA MURATA DOCCIA		2

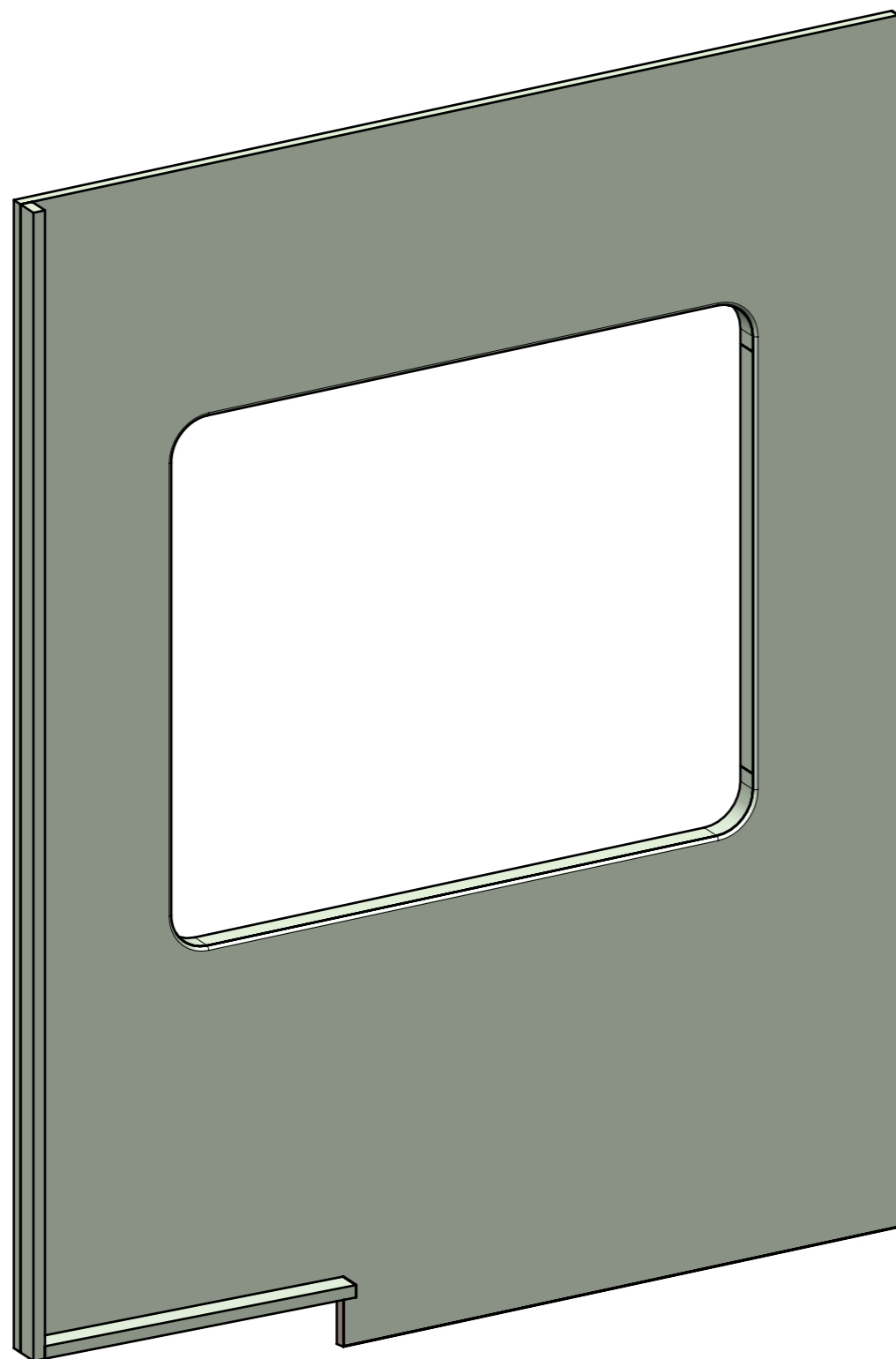

ELEMENTI DA MONTARE
in MG_JA01
e spedire con unico imballo

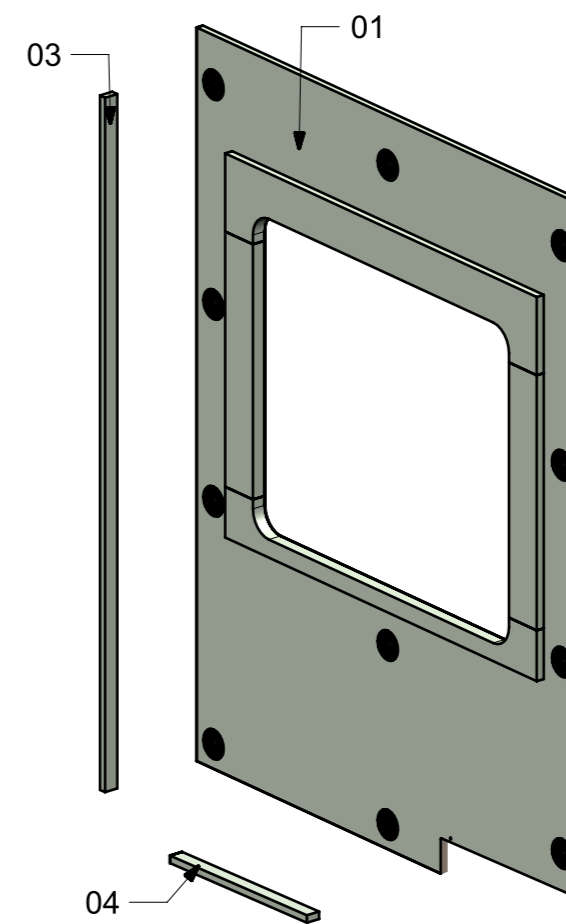
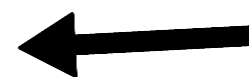

FERRAMENTA	QTY
FITLOCK M_MASCHERPA_3MM_6020202101	16

● = FILI RASATI

VERNICIATURA LASTRA/LACCATI:

● = VERNICIARE 1 LATO + FILI RASATI O BORDATI

NESSUN SIMBOLO = VERNICIARE 2 LATI + FILI RASATI O BORDATI

LOCALE	CODICE	DESCRIZIONE COMPONENTE	FINITURA	GR.
BAGNO VIP DX	MD320_MG_JB01	RIV. PARETI DOCCIA		PTP

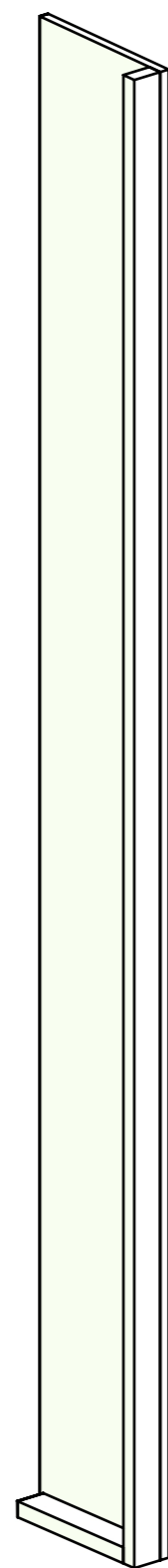

ELEMENTI DA MONTARE
in MG_JB01
e spedire con unico imballo

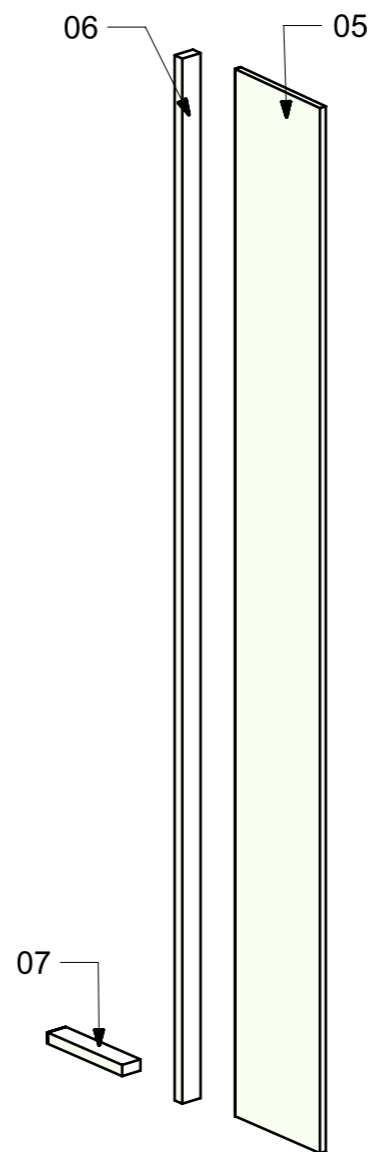

VERNICIATURA LASTRA/LACCATI:

● = FILI RASATI

● = VERNICIARE 1 LATO + FILI RASATI O BORDATI

NESSUN SIMBOLO = VERNICIARE 2 LATI + FILI RASATI O BORDATI

LOCALE	CODICE	DESCRIZIONE COMPONENTE	FINITURA	GR.
BAGNO VIP DX	MD320_MG_JC01	RIV. BASSI ALZATA DOCCIA		PTP

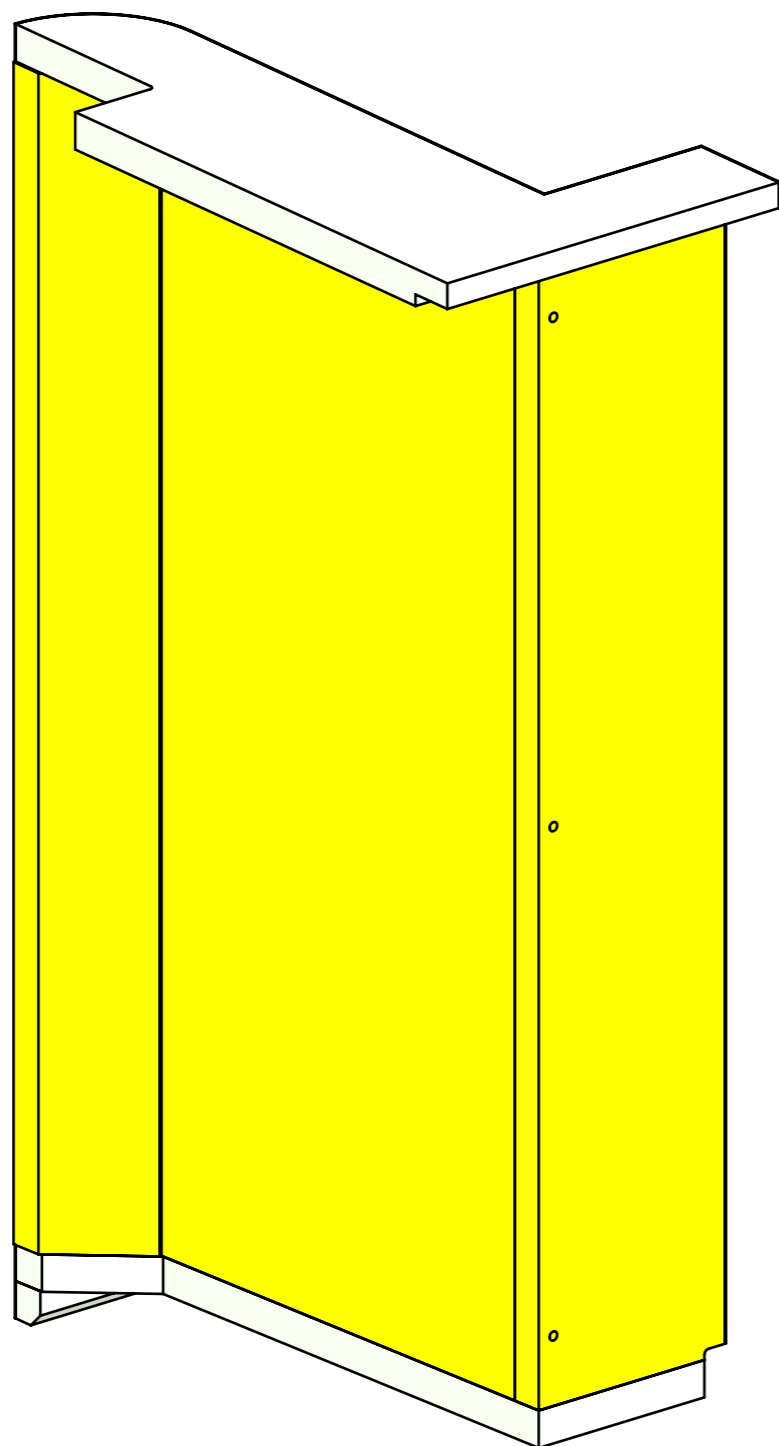

ELEMENTI DA MONTARE
in MG_JC01
e spedire con unico imballo

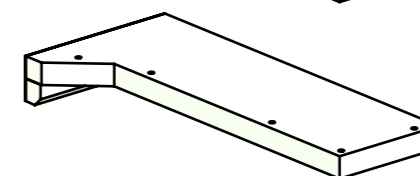
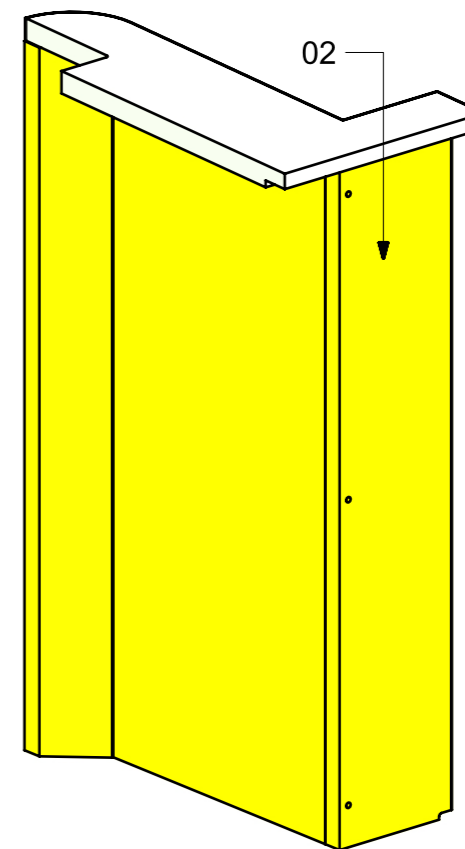

03 →

VERNICIATURA LASTRA/LACCATI:

● = FILI RASATI

● = VERNICIARE 1 LATO + FILI RASATI O BORDATI

NESSUN SIMBOLO = VERNICIARE 2 LATI + FILI RASATI O BORDATI