

| LOCALE | CODICE | DESCRIZIONE COMPONENTE | FINITURA | GR. |
|---------|------------|------------------------------------|-----------|-----|
| PARATIE | MD320_PR10 | PARATIA BAGNO_CABINA VIP DX MURATA | LARICROSS | 4 |

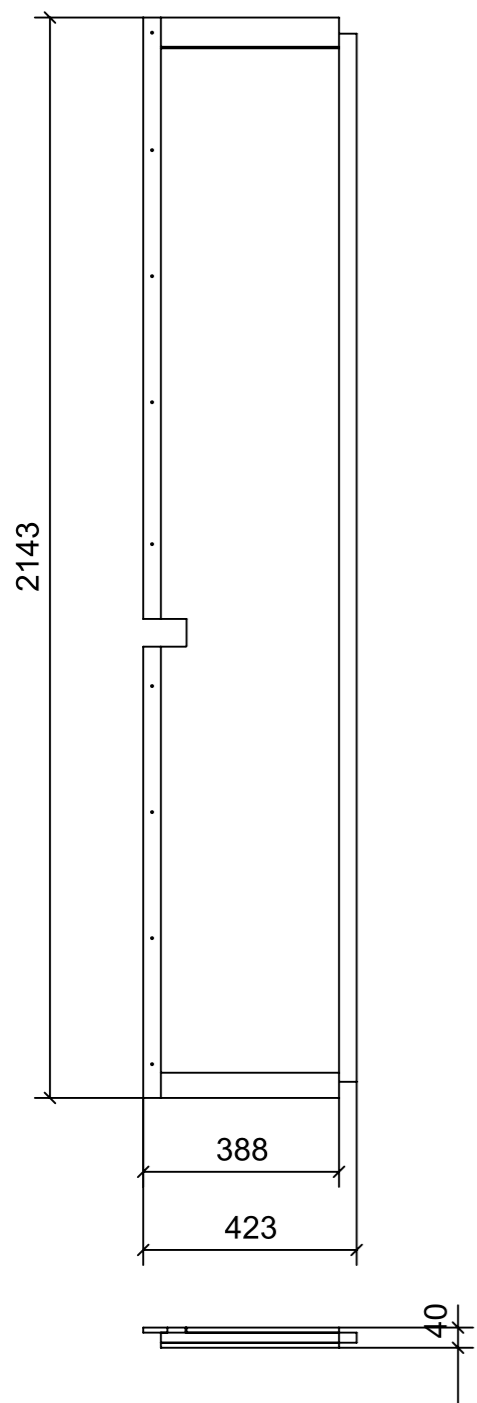

01

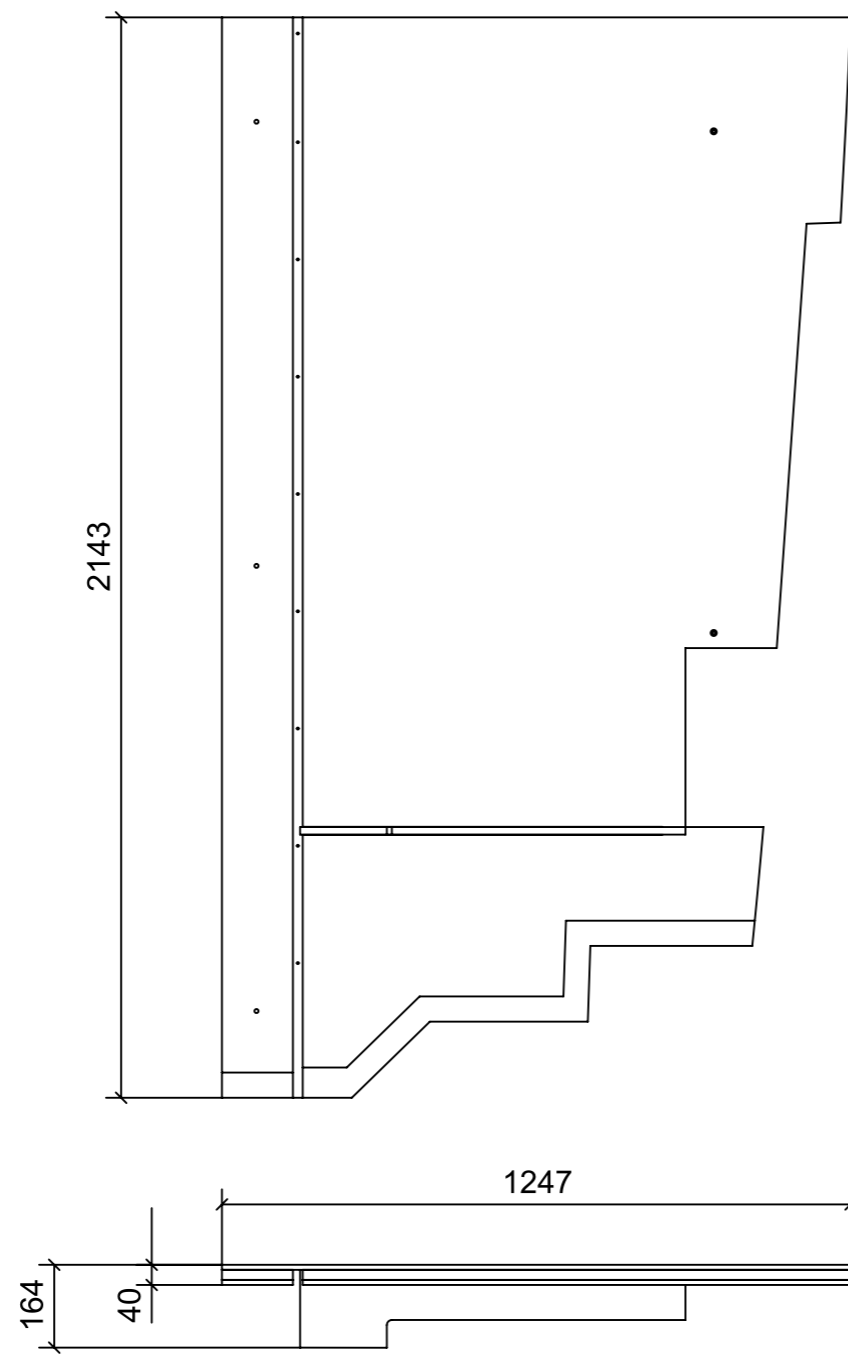

02

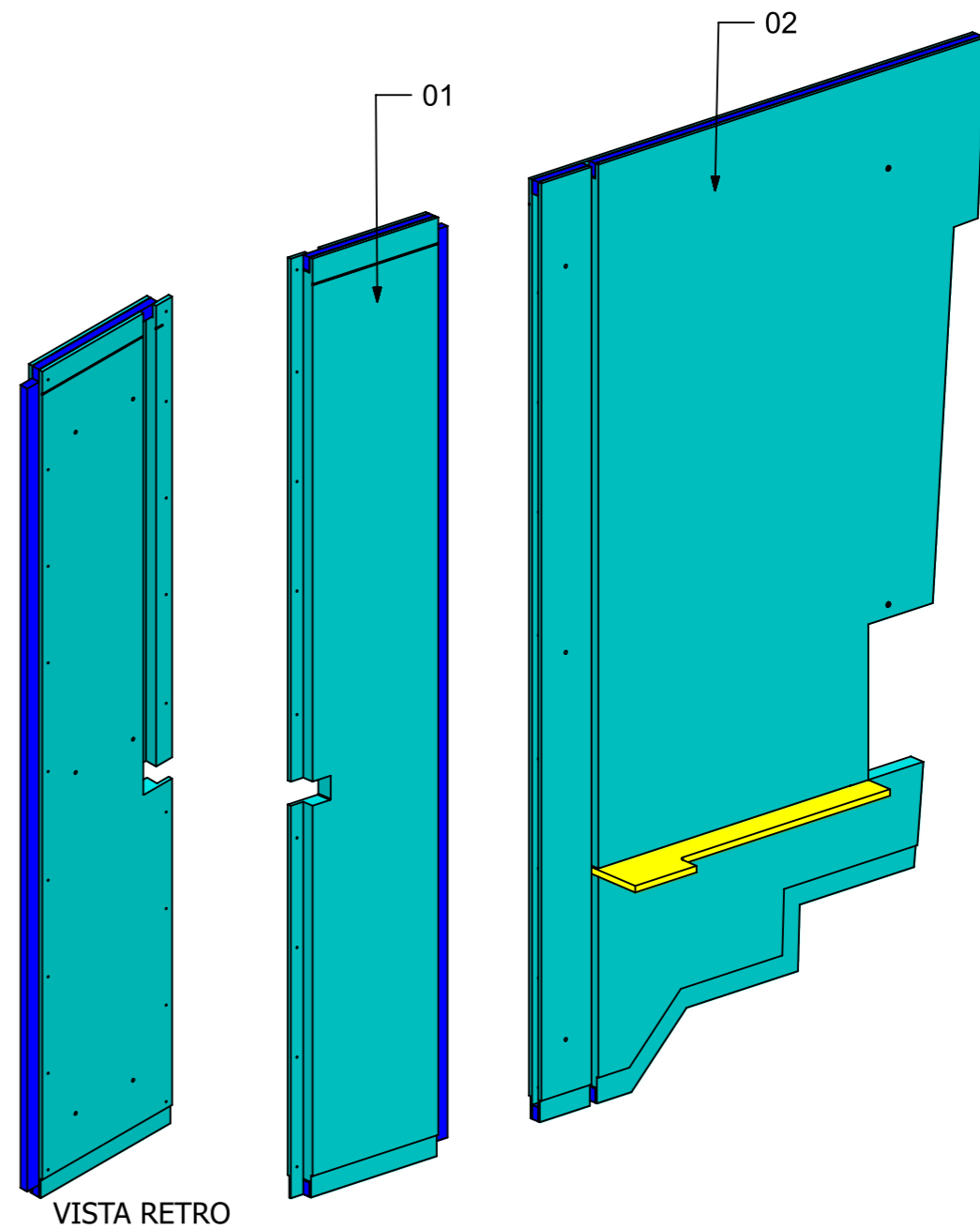

VISTA RETRO

| FERRAMENTA | QTY |
|------------------------------|-----|
| BUSSOLA 6MA X 10 FORO DIAM.8 | 4 |

| LOCALE | CODICE | DESCRIZIONE COMPONENTE | FINITURA | GR. |
|------------|------------|----------------------------|---------------|-----|
| PARATIE LD | MD320_PR11 | PARATIA PORTA BAGNO VIP DX | OKUME' GREZZO | 4 |

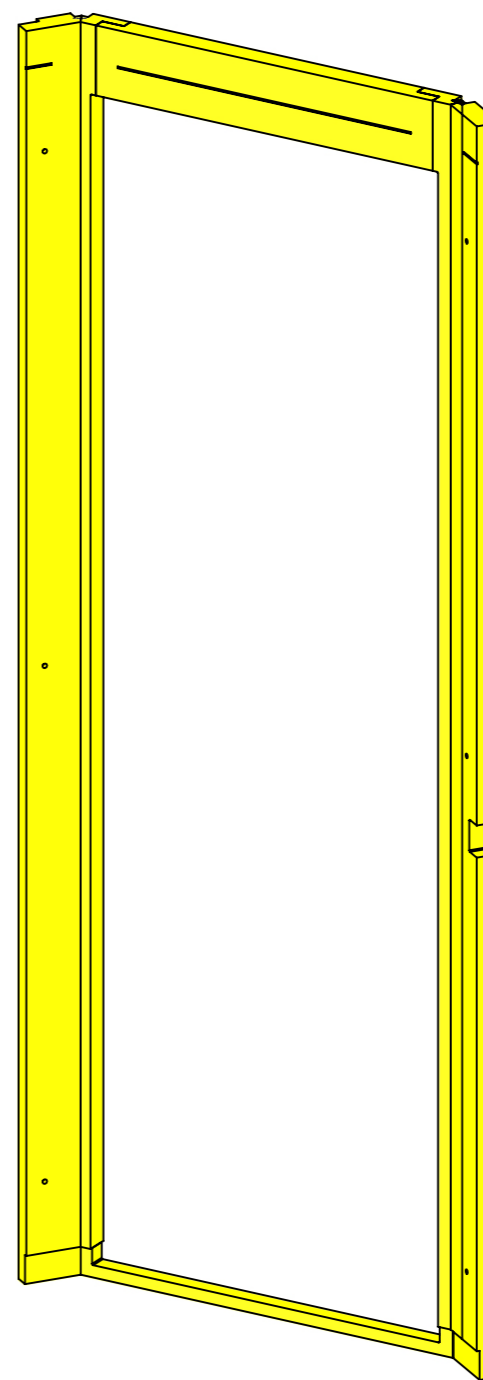
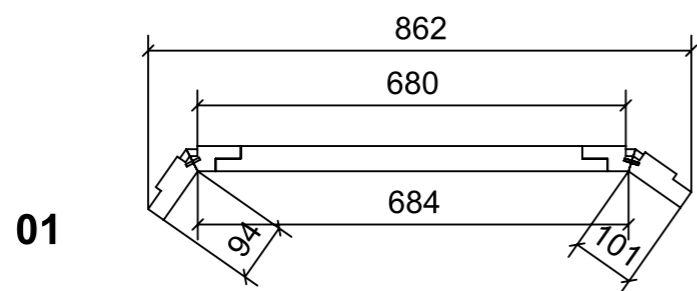
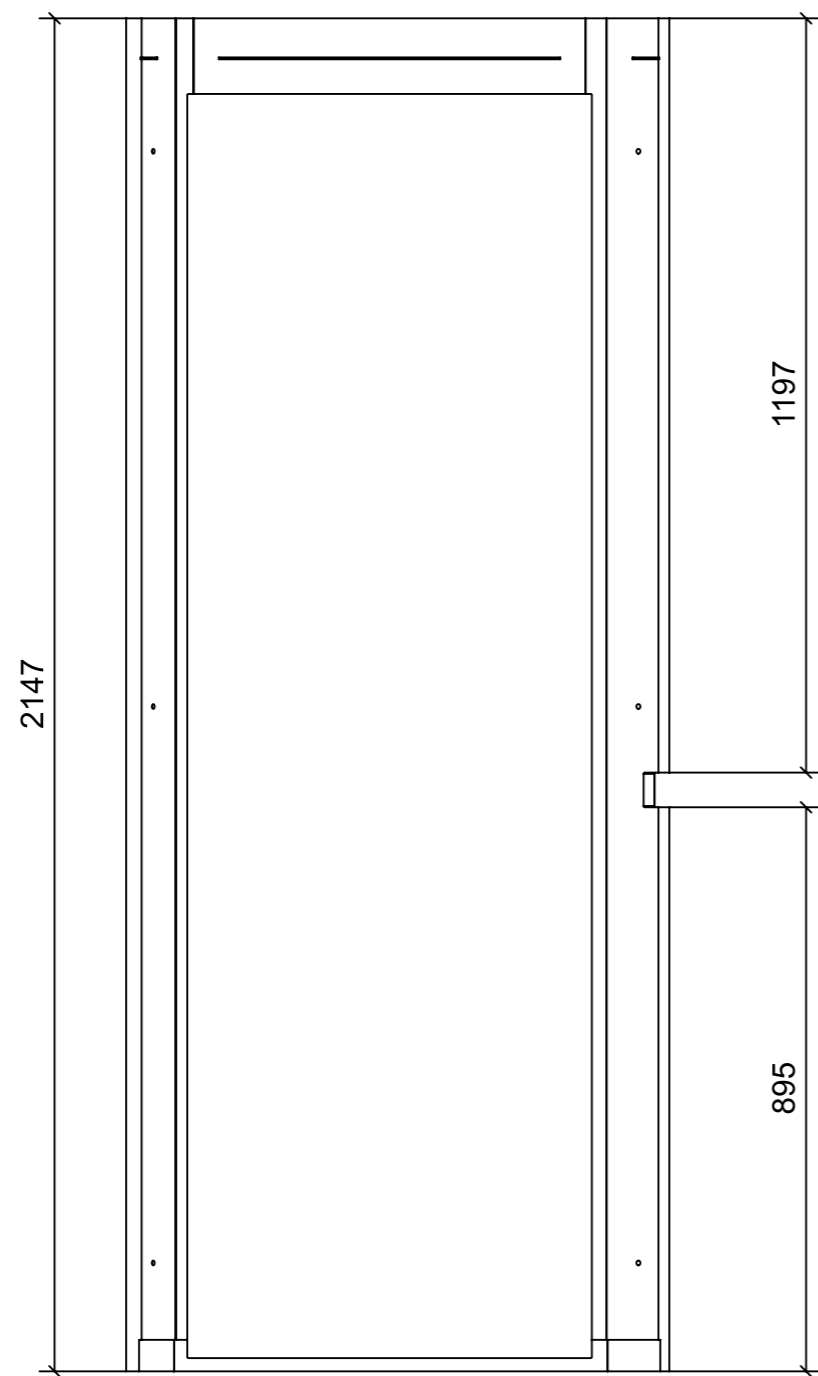

| | | | | |
|---------------|---------------|----------------------------------|------------------|------------|
| LOCALE | CODICE | DESCRIZIONE COMPONENTE | FINITURA | GR. |
| PARATIE LD | MD320_PR12 | PARATIA BAGNO VIP DX CENTRO NAVE | LARICROSS/GREZZO | 4 |

GREZZO
ANTI ROMBO

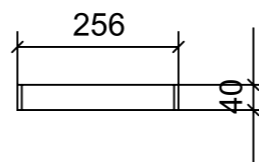
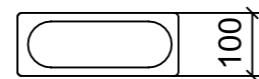

02

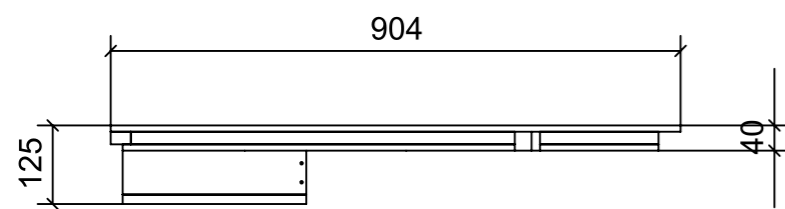
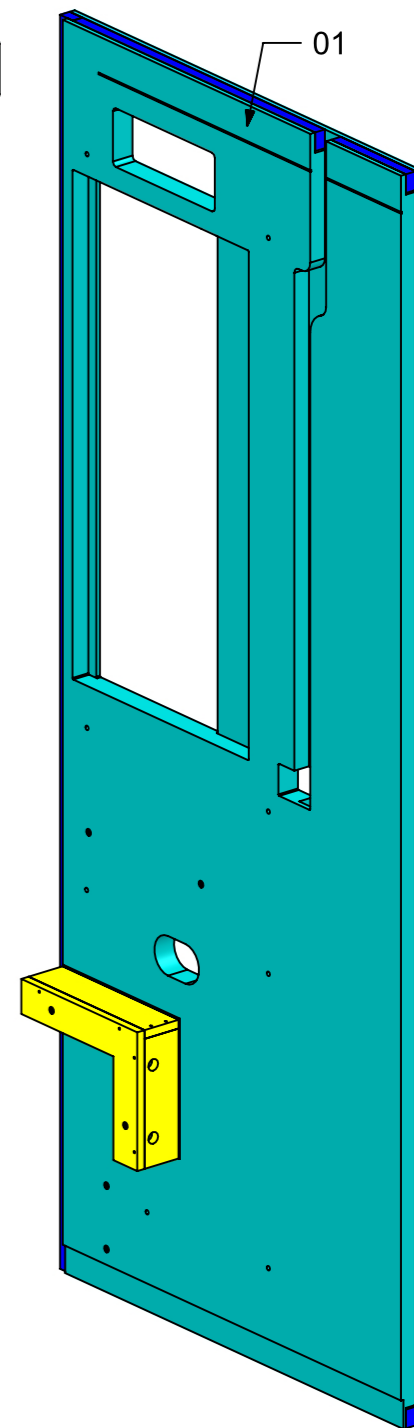
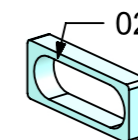
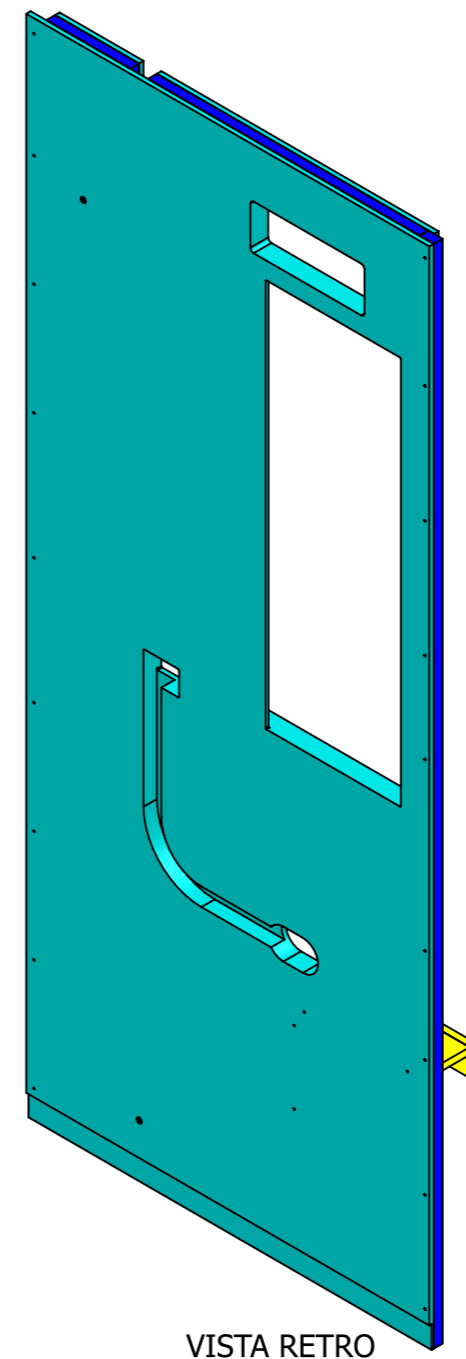
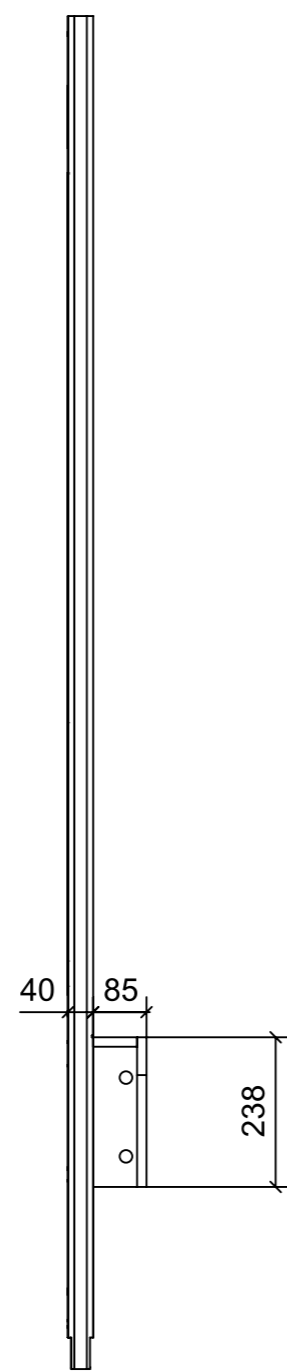
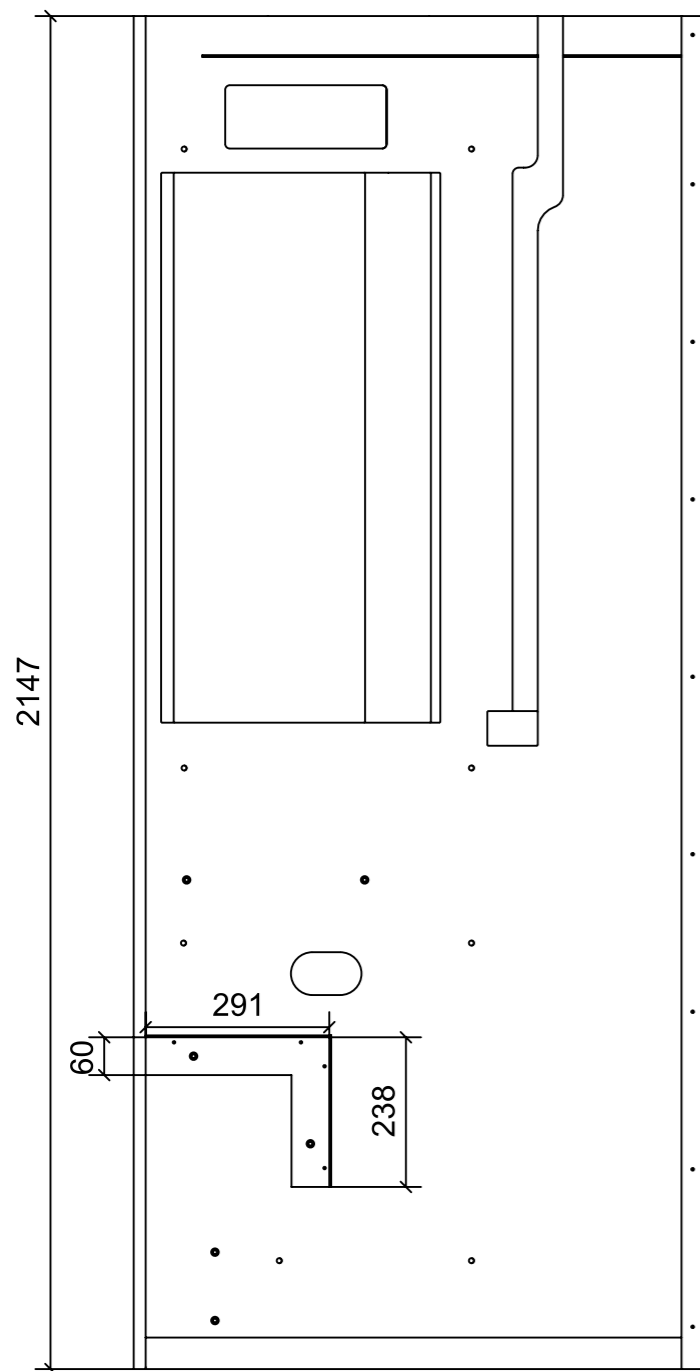

01

VISTA RETRO

| FERRAMENTA | QTY |
|------------------------------|-----|
| BUSSOLA 6MA X 10 FORO DIAM.8 | 8 |

| LOCALE | CODICE | DESCRIZIONE COMPONENTE | FINITURA | GR. |
|------------|------------|-----------------------------------|---------------|-----|
| PARATIE LD | MD320_PR13 | PARATIA BAGNO VIP DX PORTA DOCCIA | OKUME' GREZZO | PTP |

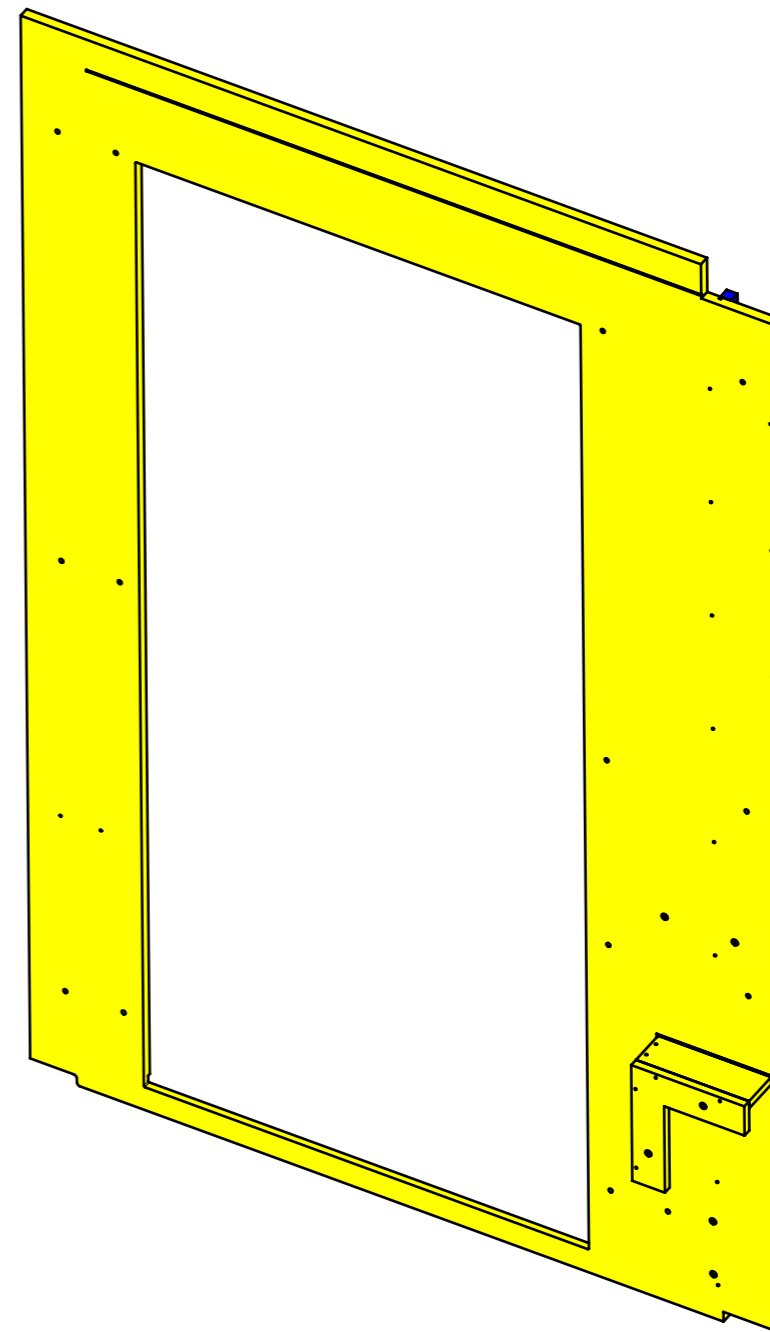
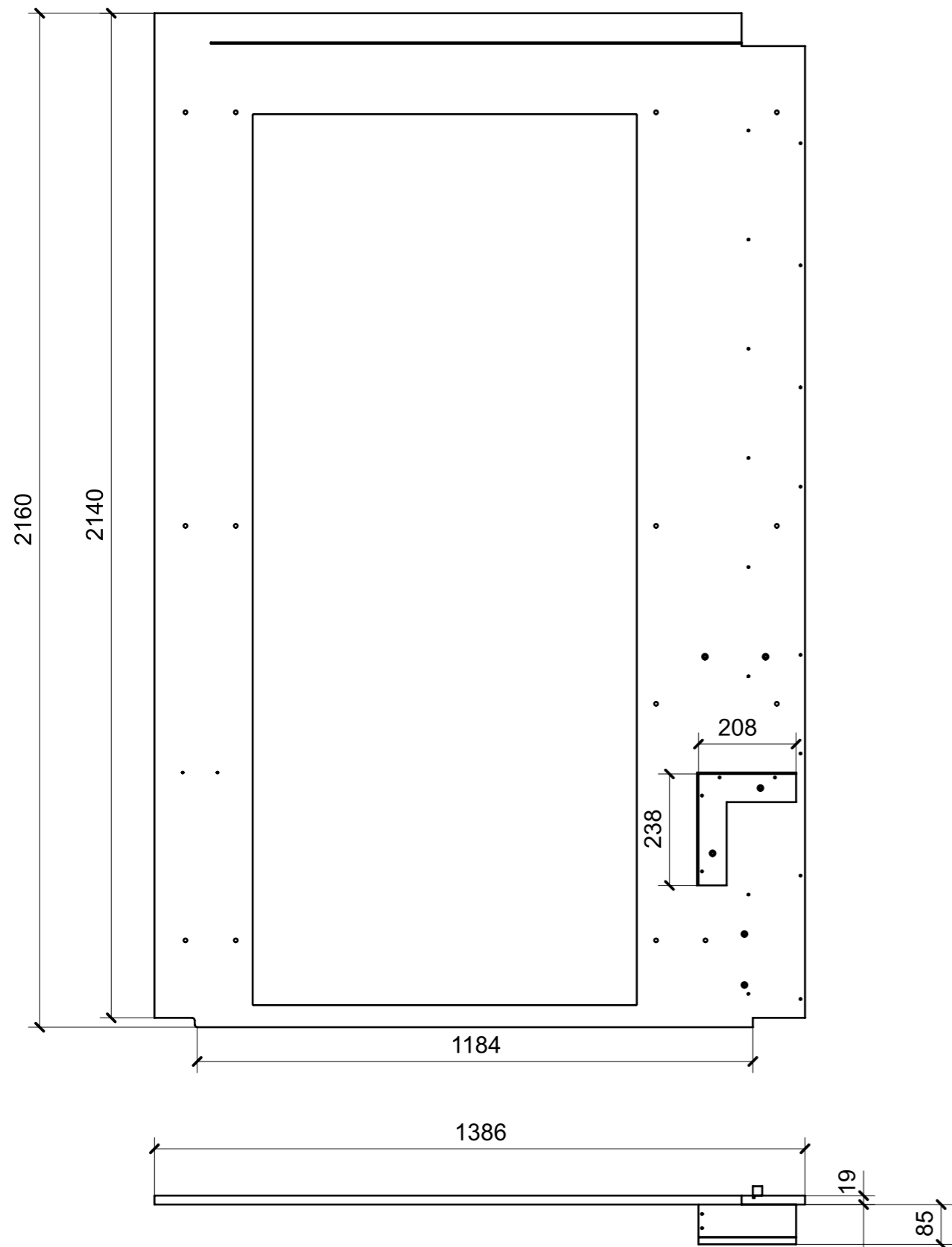

01

| FERRAMENTA | QTY |
|------------------------------|-----|
| BUSSOLA 6MA X 10 FORO DIAM.8 | 6 |

| LOCALE | CODICE | DESCRIZIONE COMPONENTE | FINITURA | GR. |
|------------|------------|-----------------------------------|---------------|-----|
| PARATIE LD | MD320_PR14 | PARATIA BAGNO VIP DX POPPA MURATA | OKUME' GREZZO | 2 |

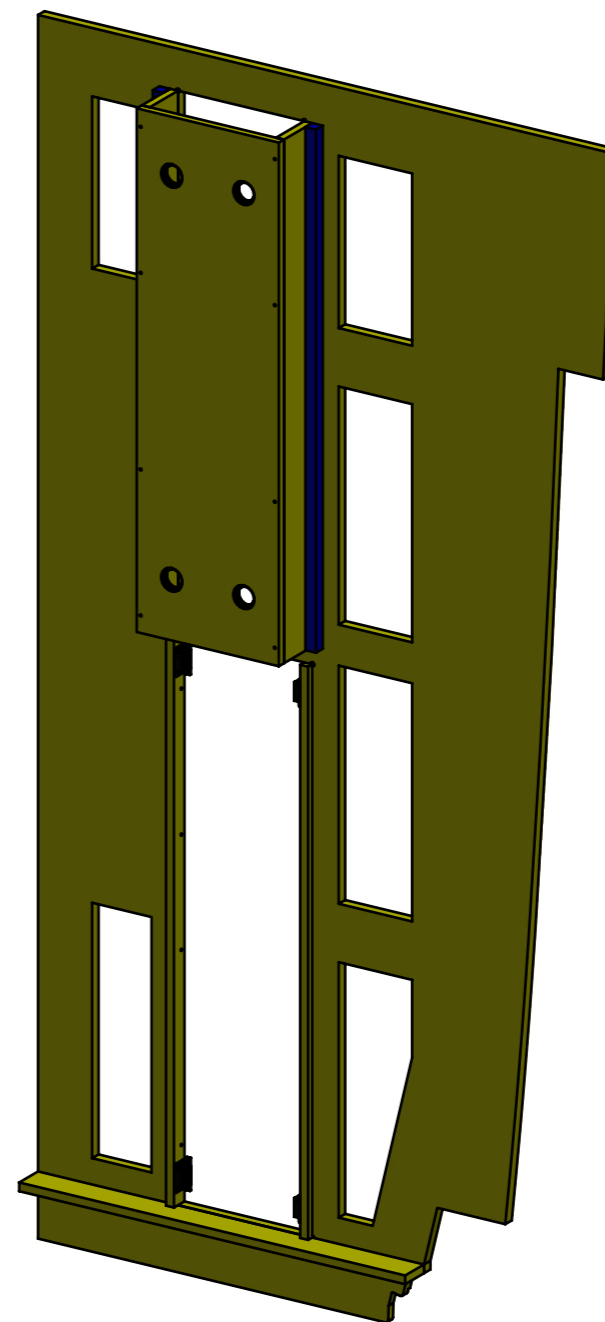
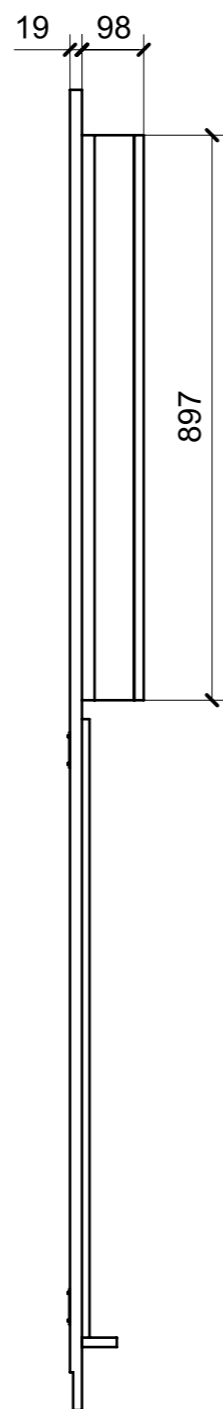
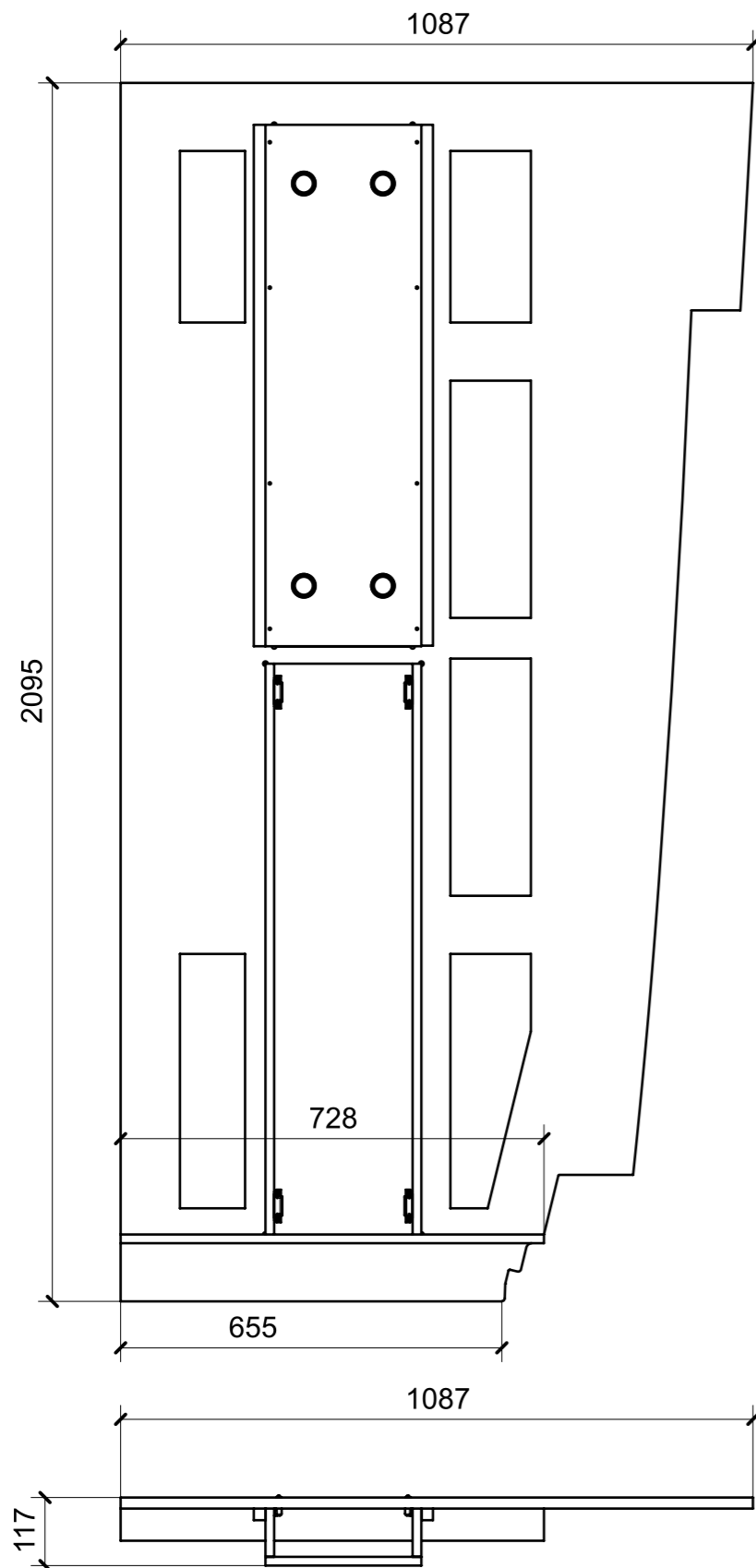

01

| FERRAMENTA | QTY |
|--|-----|
| BUSSOLA 6MA X 10 FORO DIAM.8 | 3 |
| FITLOCK F_MASCHERPA_6020101102 | 4 |
| CHIUSURA A SPINTA_TECHNOPARTNER_SOU C3-203 | 4 |

| LOCALE | CODICE | DESCRIZIONE COMPONENTE | FINITURA | GR. |
|------------|------------|-----------------------------------|-------------------------------------|-----|
| PARATIE LD | MD320_PR15 | PARATIA BAGNO VIP DX POPPA LAVABO | CARTA MELAMINICA NERA/OKUME' GREZZO | 2 |

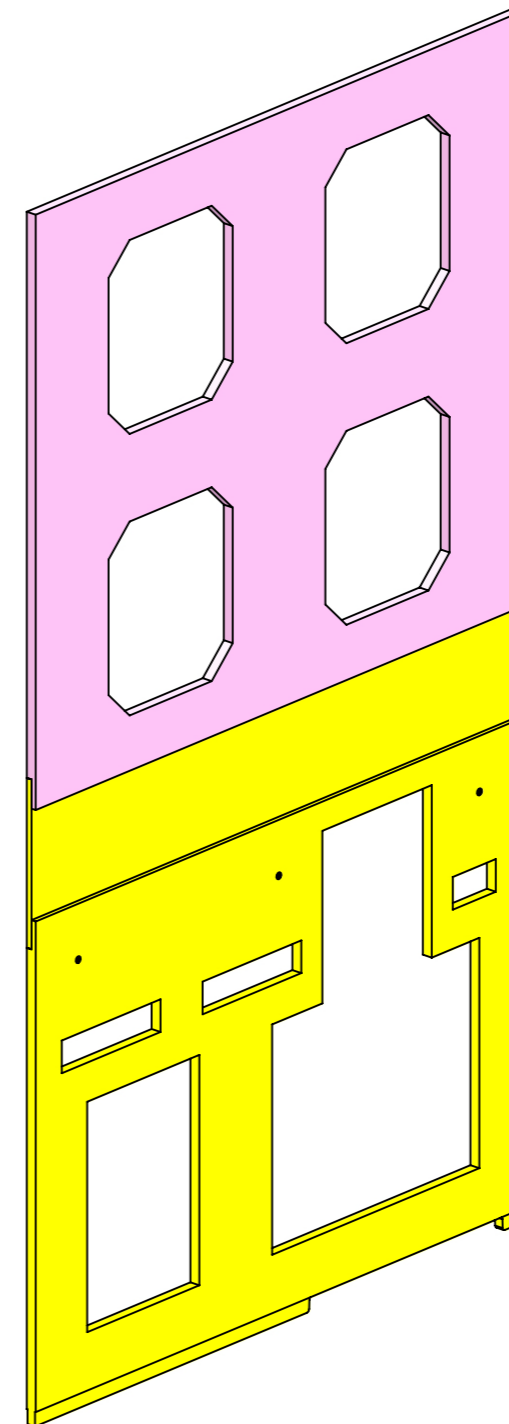
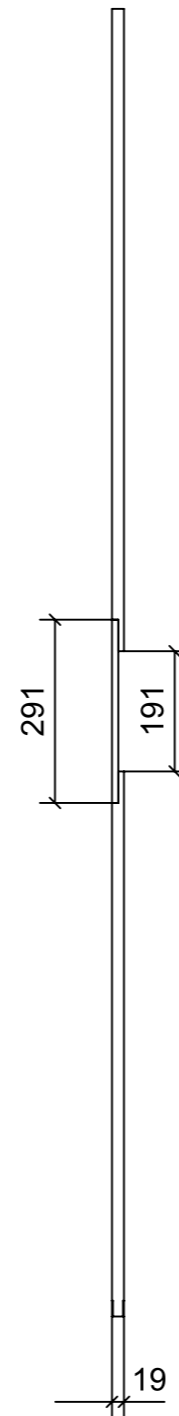
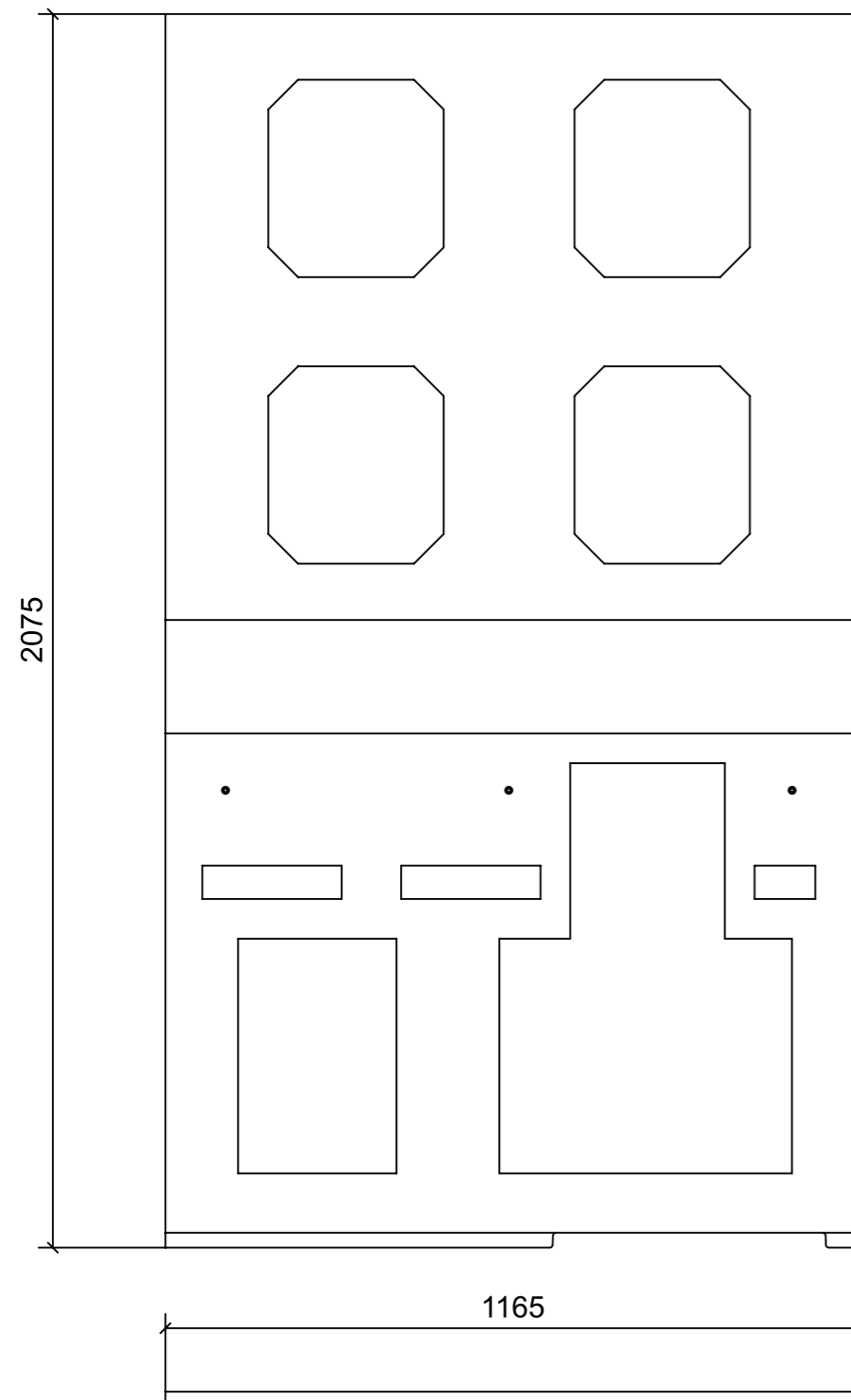

01

| FERRAMENTA | QTY |
|------------------------------|-----|
| BUSSOLA 6MA X 10 FORO DIAM.8 | 3 |

| LOCALE | CODICE | DESCRIZIONE COMPONENTE | FINITURA | GR. |
|------------|------------|------------------------------------|---------------------------|-----|
| PARATIE LD | MD320_PR16 | PARATIA BAGNO_CABINA VIP SX MURATA | LARICROSS / OKUME' GREZZO | 4 |

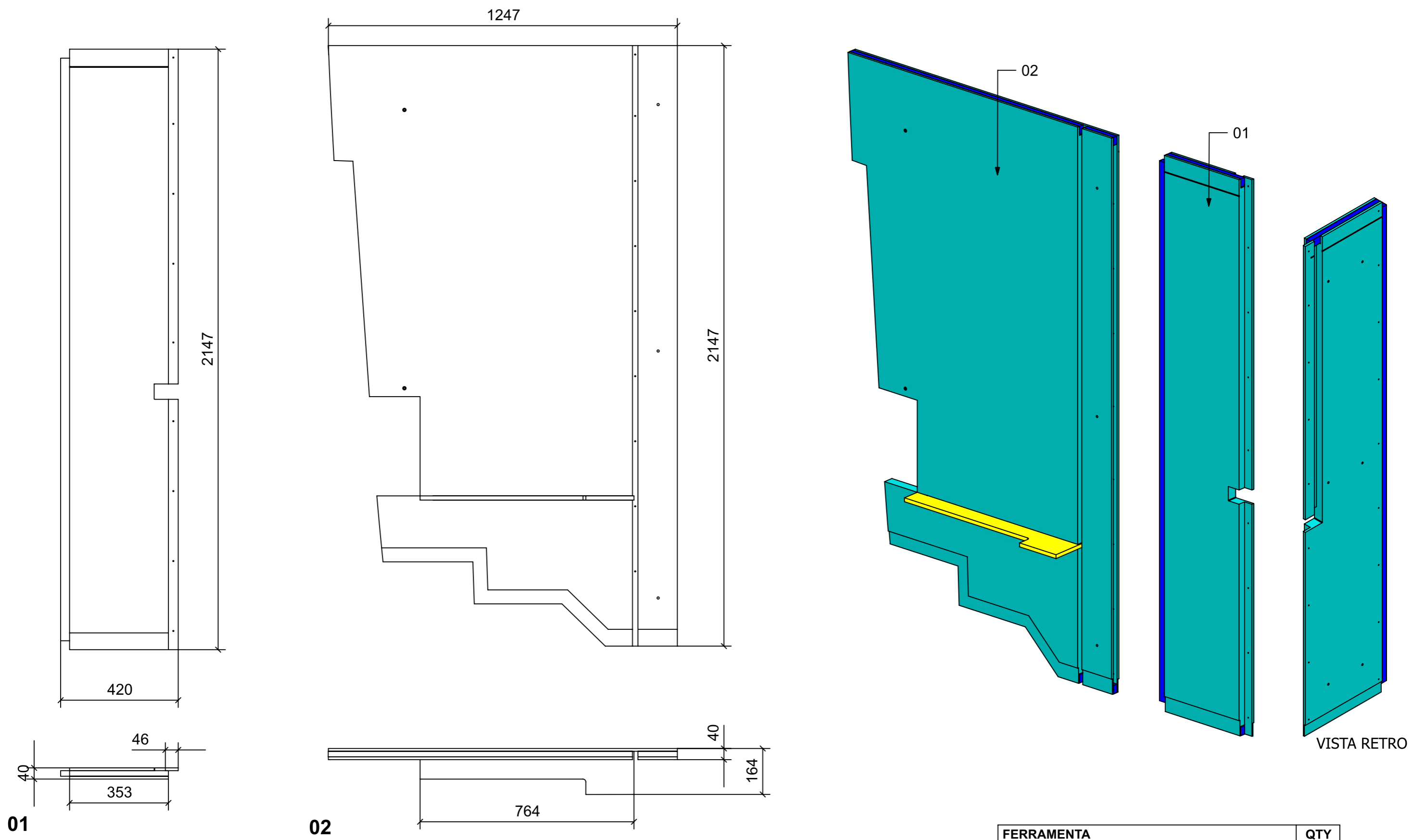

| FERRAMENTA | QTY |
|------------------------------|-----|
| BUSSOLA 6MA X 10 FORO DIAM.8 | 4 |

| LOCALE | CODICE | DESCRIZIONE COMPONENTE | FINITURA | GR. |
|------------|------------|----------------------------|---------------|-----|
| PARATIE LD | MD320_PR17 | PARATIA PORTA BAGNO VIP SX | OKUME' GREZZO | 4 |

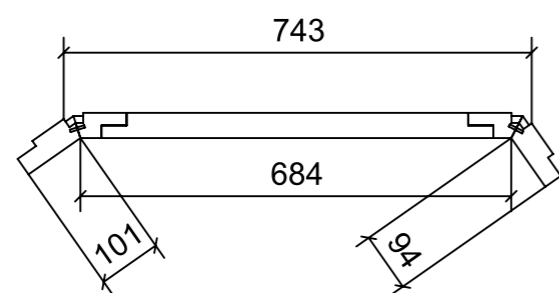
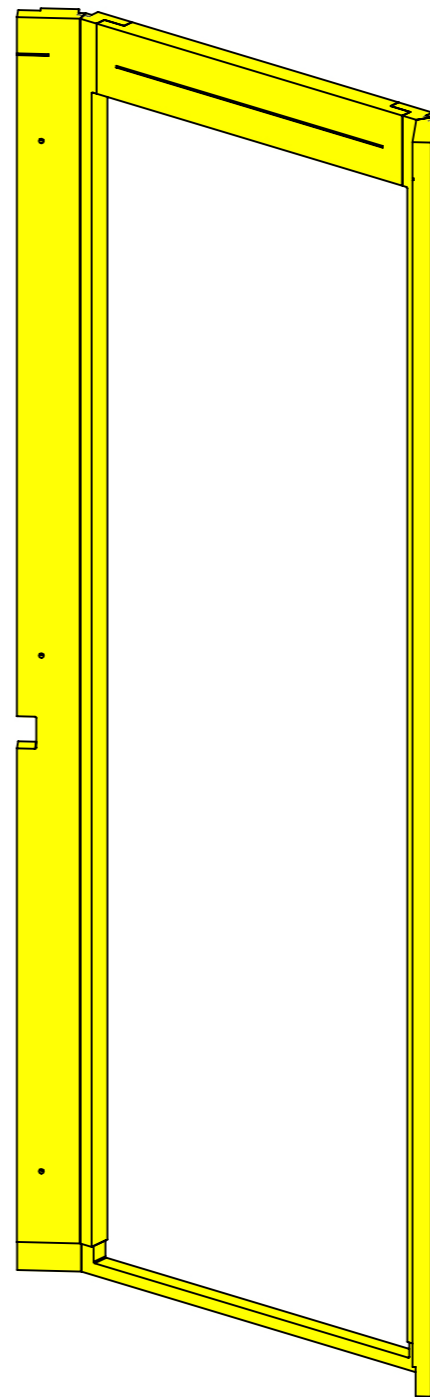
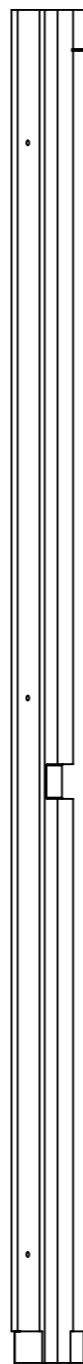
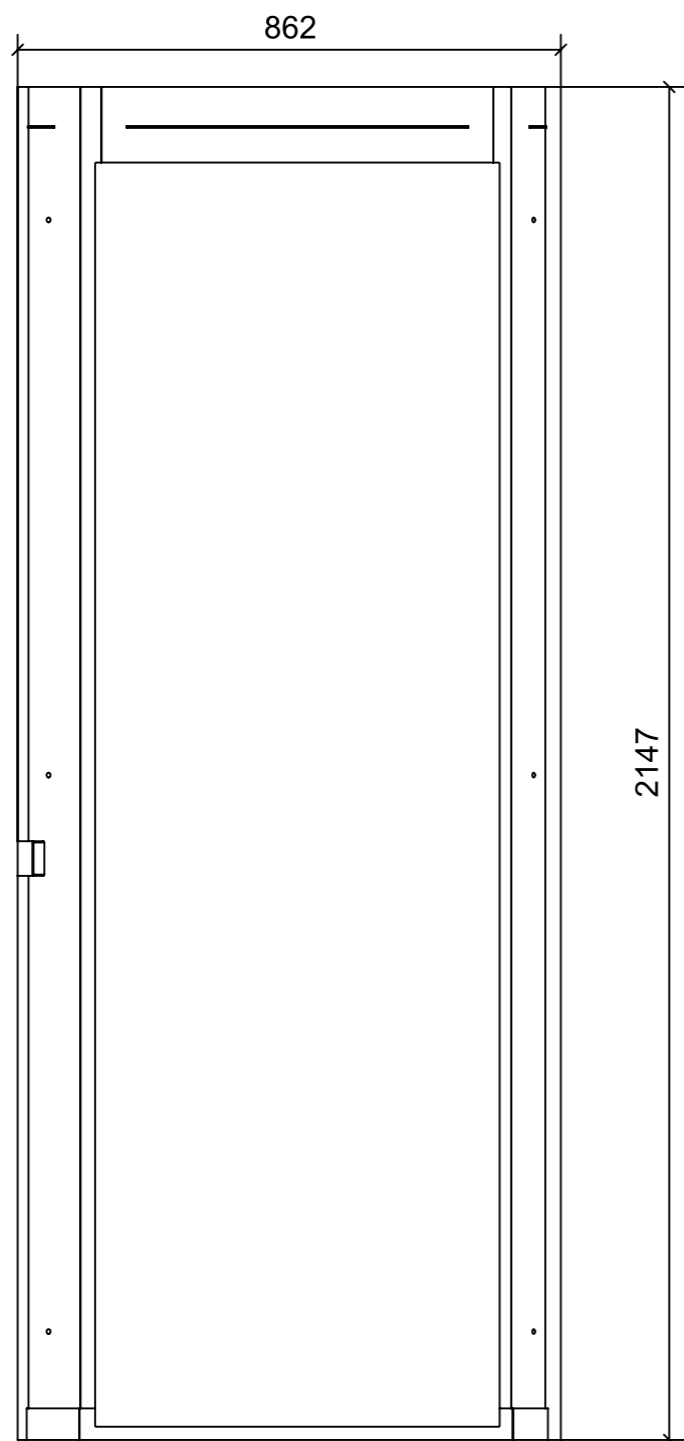

01

| LOCALE | CODICE | DESCRIZIONE COMPONENTE | FINITURA | GR. |
|------------|------------|----------------------------------|-------------------|-----|
| PARATIE LD | MD320_PR18 | PARATIA BAGNO VIP SX CENTRO NAVE | LARICROSS/ GREZZO | 4 |

GREZZO
ANTI ROMBO

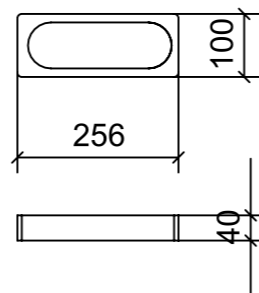

02

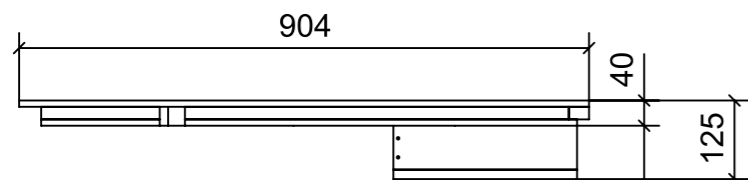
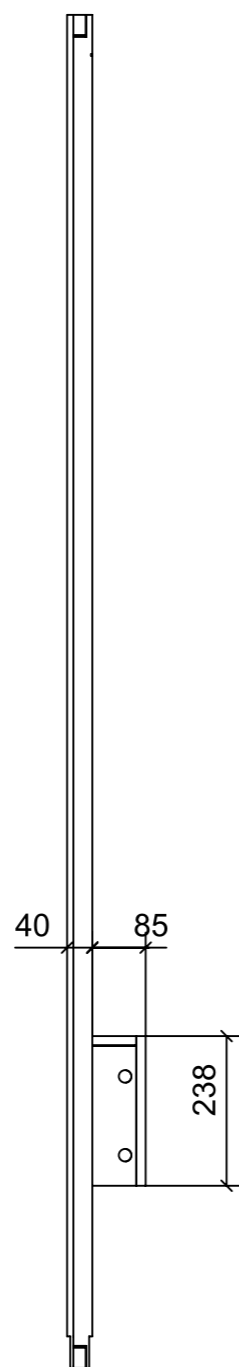
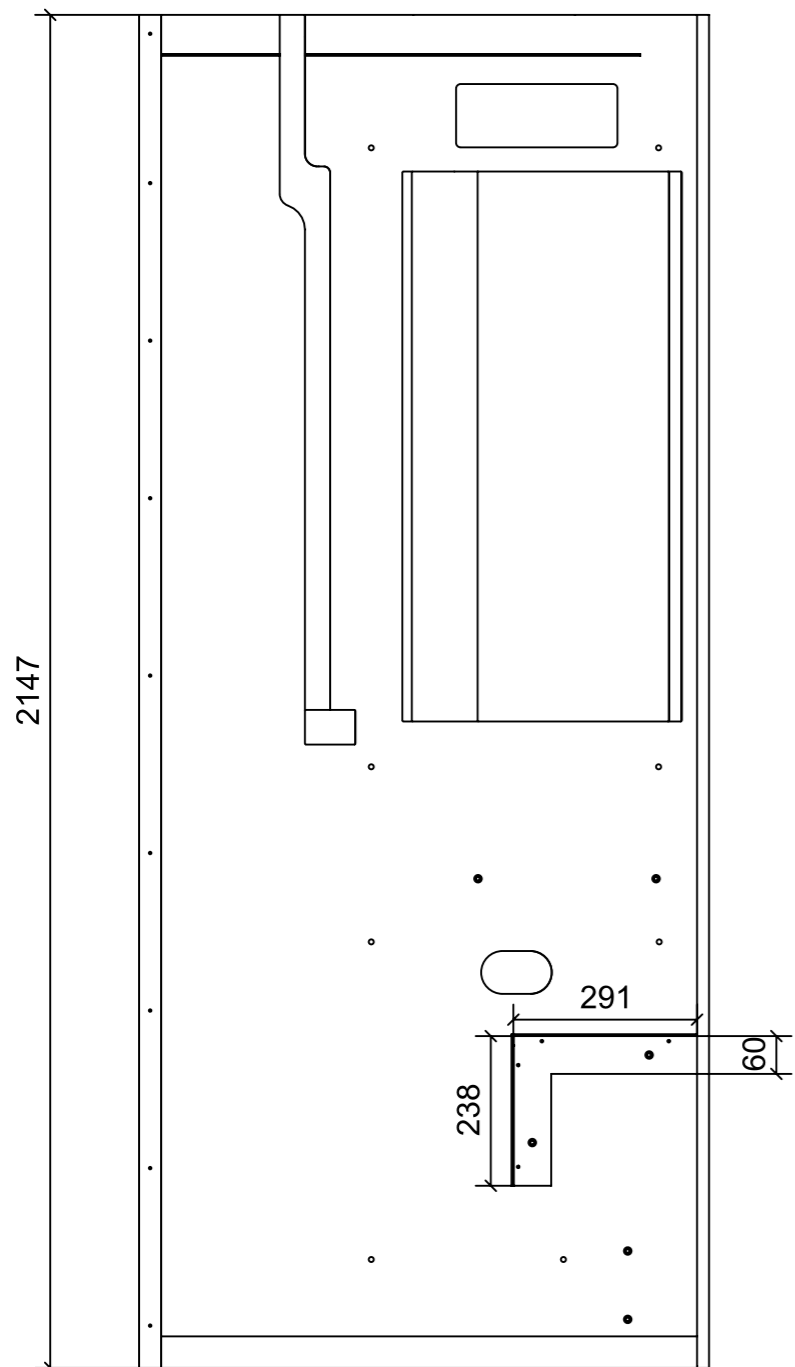
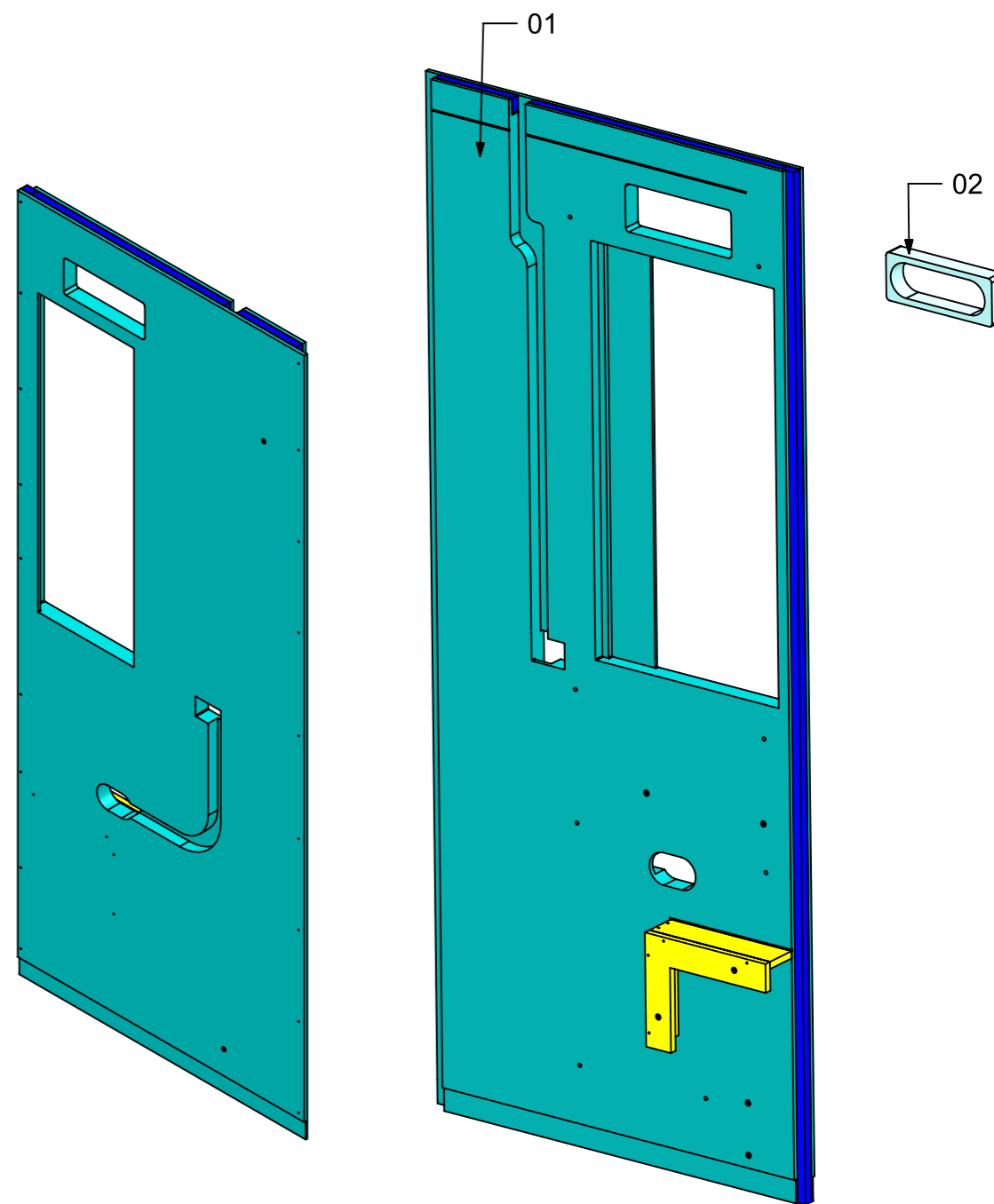

01

| FERRAMENTA | QTY |
|------------------------------|-----|
| BUSSOLA 6MA X 10 FORO DIAM.8 | 8 |

| LOCALE | CODICE | DESCRIZIONE COMPONENTE | FINITURA | GR. |
|------------|------------|-----------------------------------|---------------|-----|
| PARATIE LD | MD320_PR19 | PARATIA BAGNO VIP SX PORTA DOCCIA | OKUME' GREZZO | PTP |

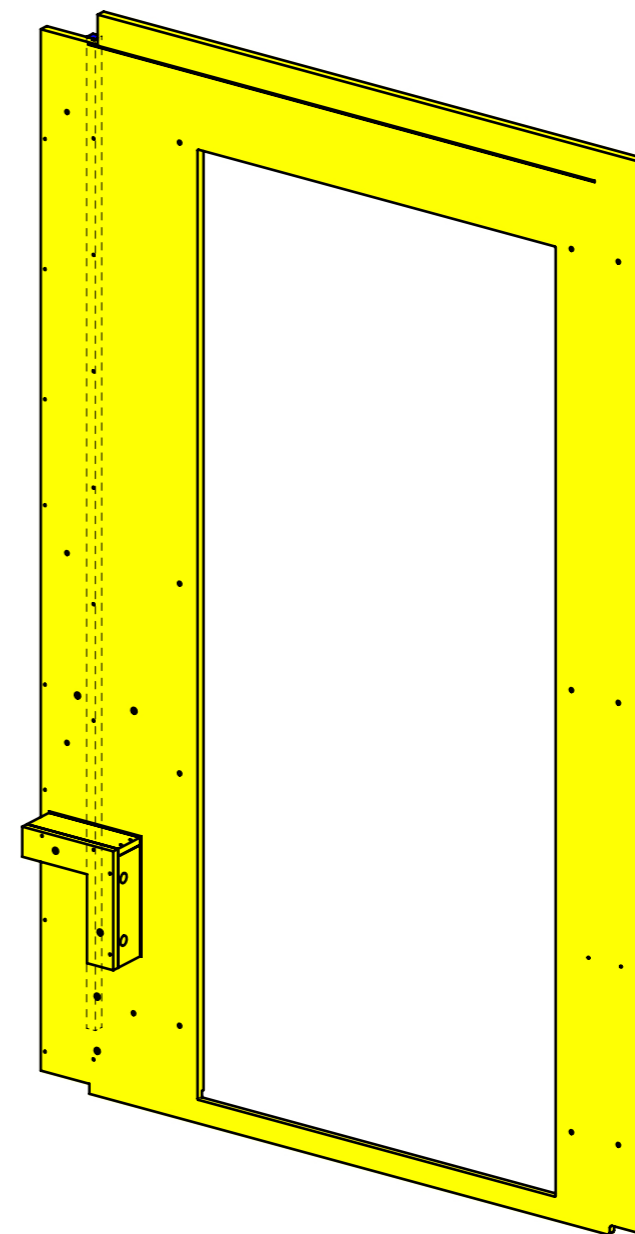
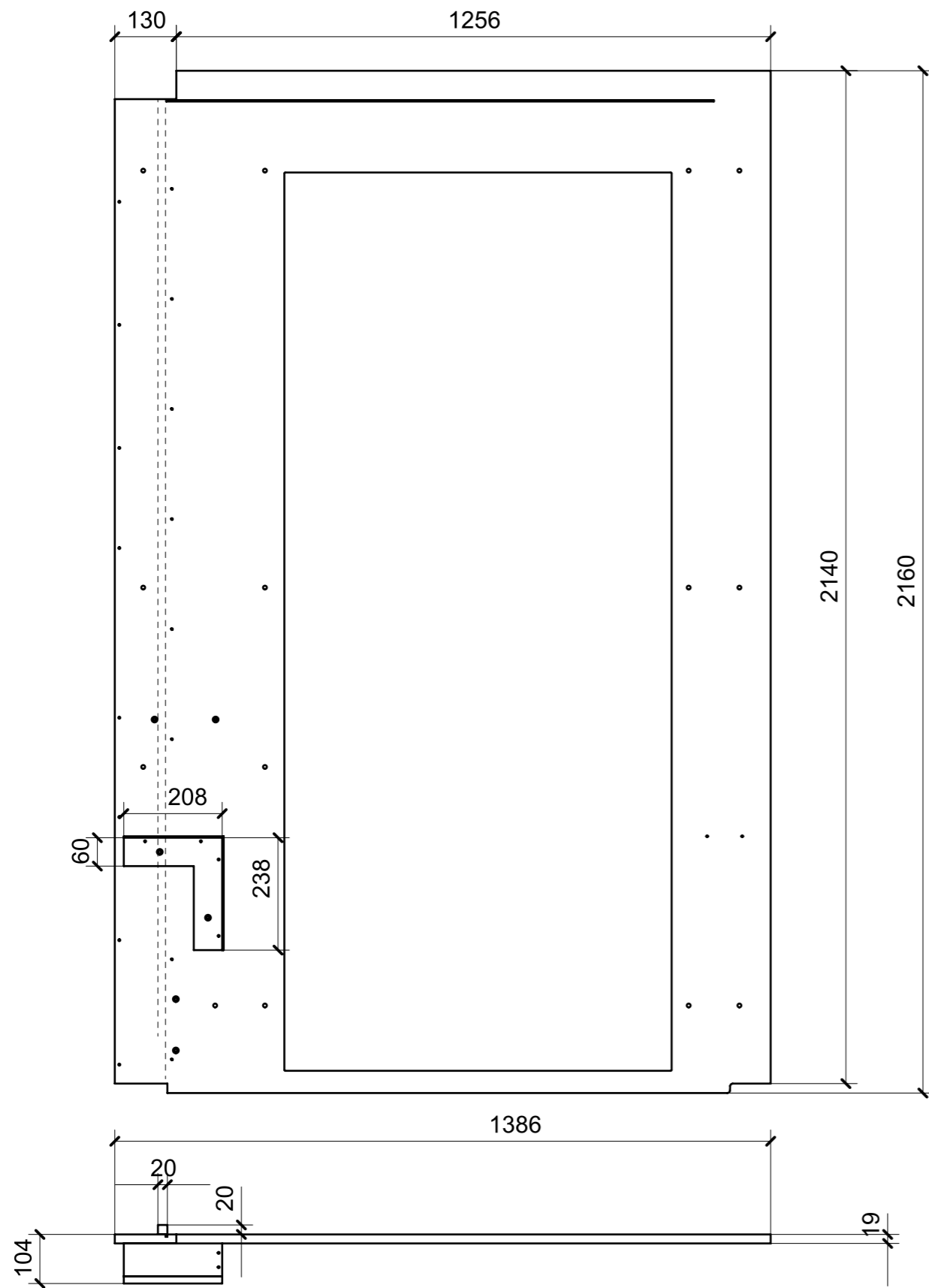

| FERRAMENTA | QTY |
|------------------------------|-----|
| BUSSOLA 6MA X 10 FORO DIAM.8 | 6 |

01

| LOCALE | CODICE | DESCRIZIONE COMPONENTE | FINITURA | GR. |
|------------|------------|-----------------------------------|---------------|-----|
| PARATIE LD | MD320_PR20 | PARATIA BAGNO VIP SX POPPA MURATA | OKUME' GREZZO | 2 |

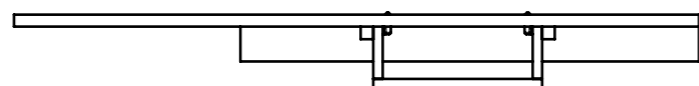
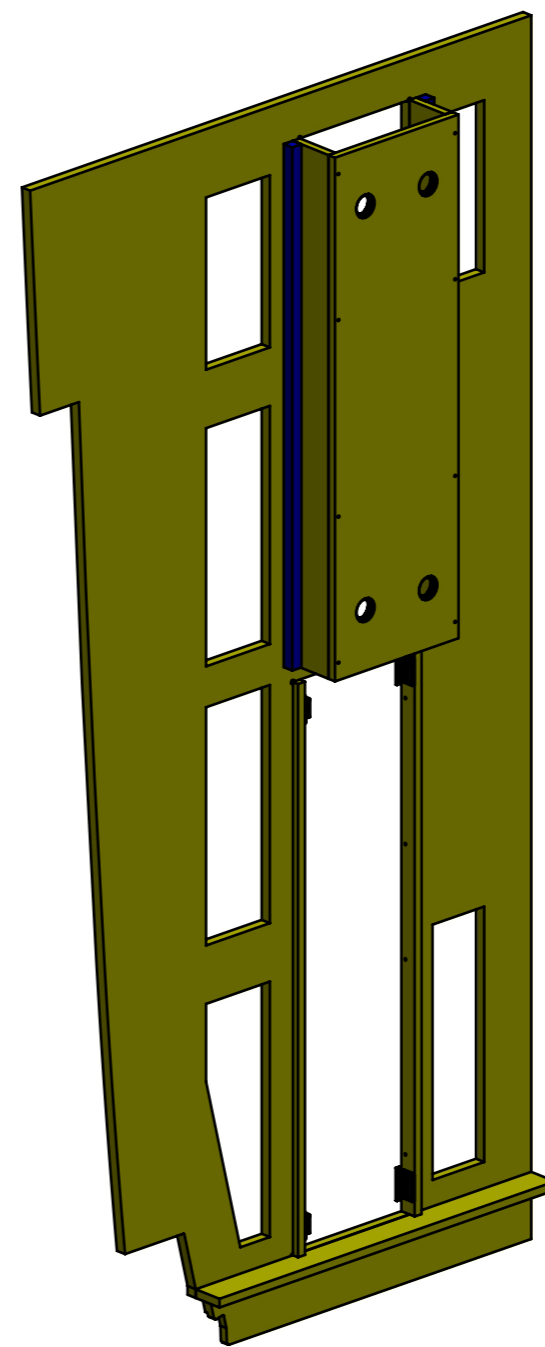
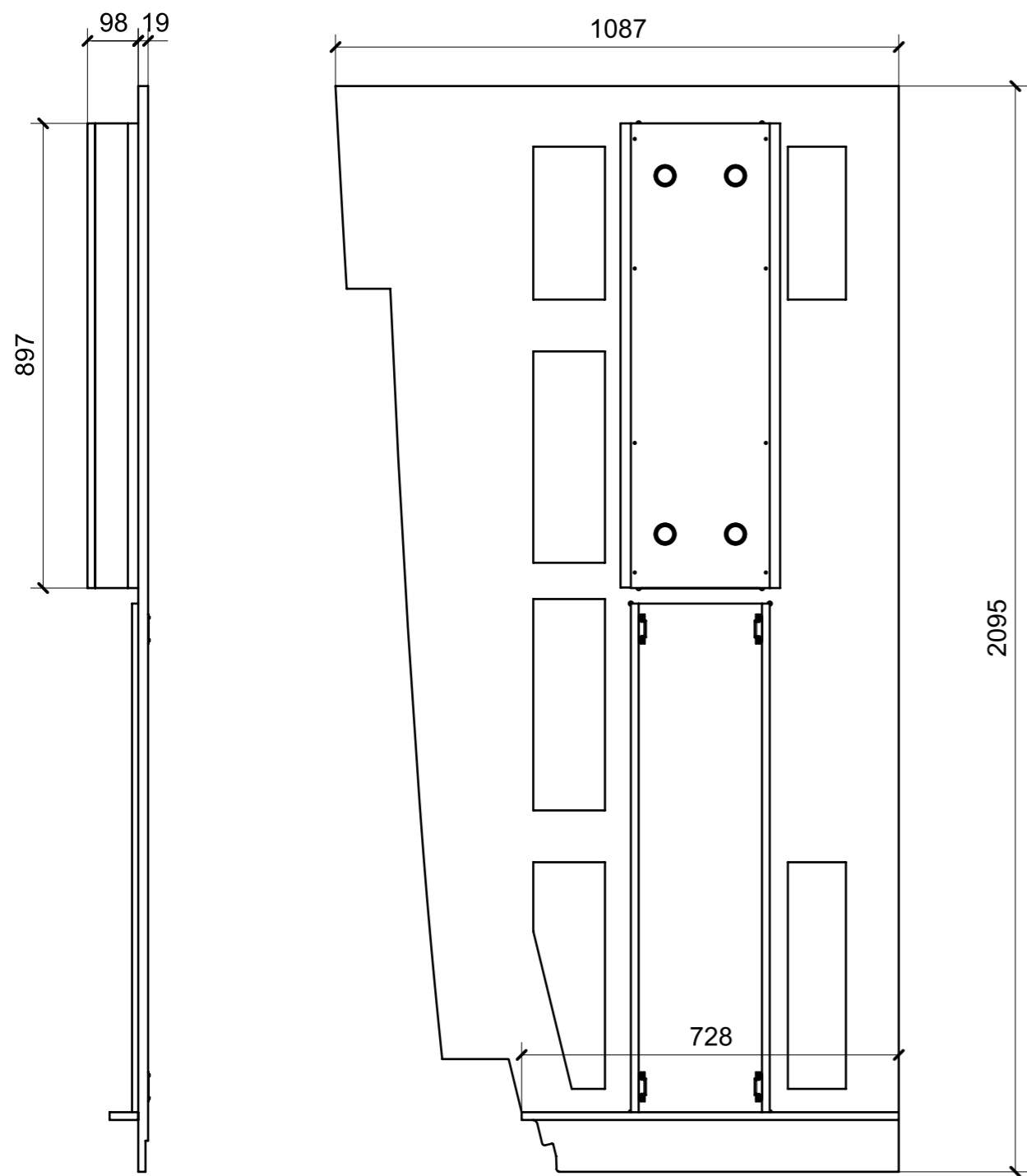

01

| FERRAMENTA | QTY |
|--|-----|
| BUSSOLA 6MA X 10 FORO DIAM.8 | 3 |
| CHIUSURA A SPINTA_TECHNOPARTNER_SOU C3-203 | 4 |
| FITLOCK F_MASCHERPA_6020101102 | 4 |

| LOCALE | CODICE | DESCRIZIONE COMPONENTE | FINITURA | GR. |
|------------|------------|-----------------------------------|--------------------------------------|-----|
| PARATIE LD | MD320_PR21 | PARATIA BAGNO VIP SX POPPA LAVABO | CARTA MELAMINICA NERA /OKUME' GREZZO | 2 |

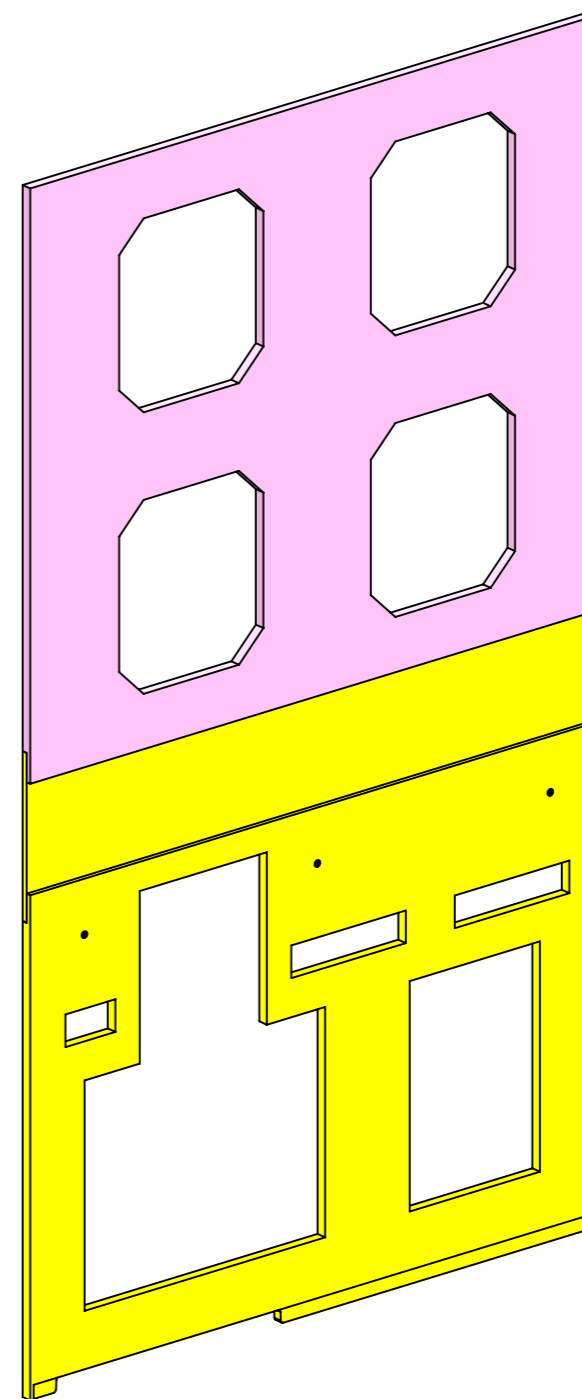
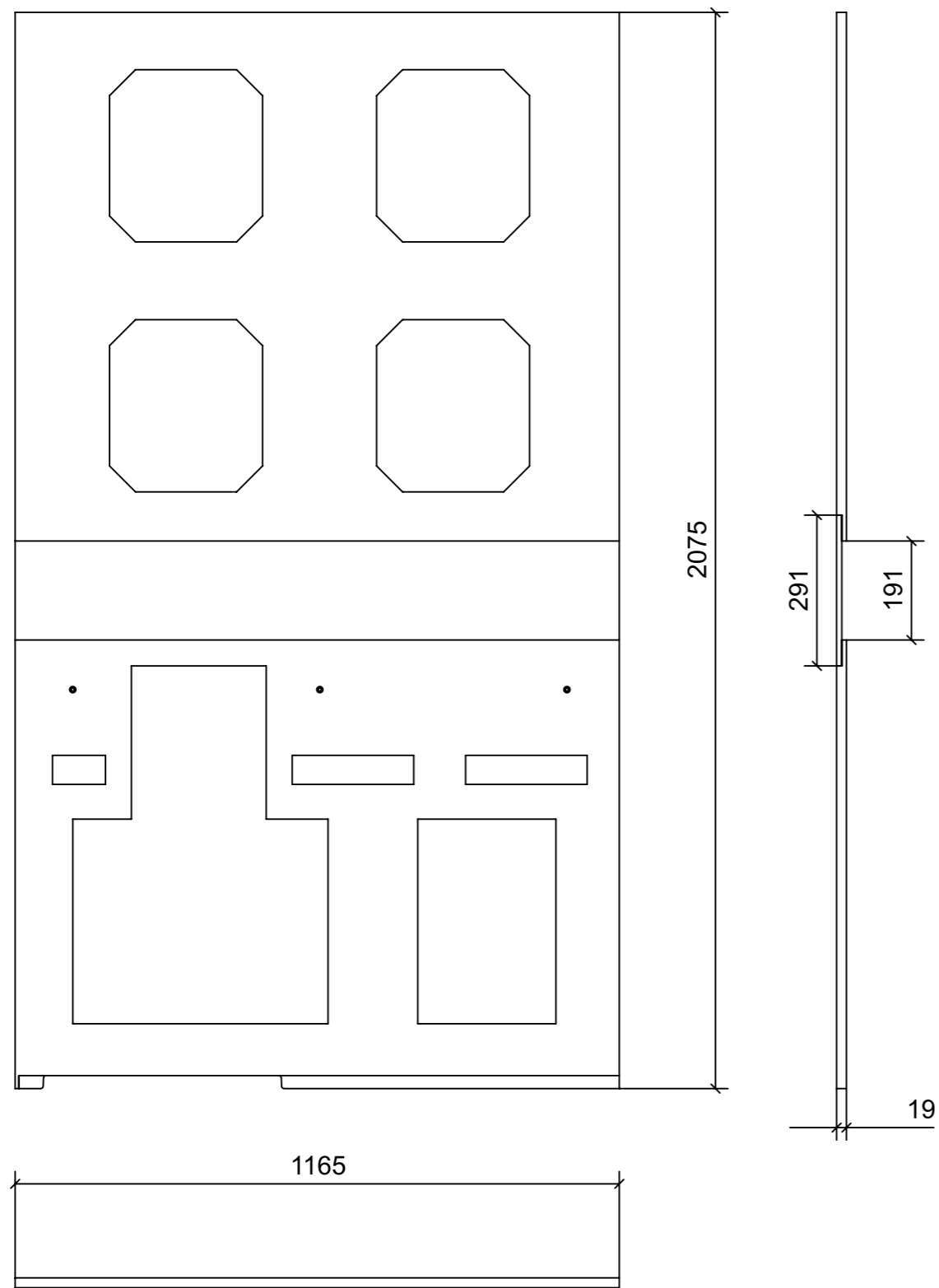

01

| FERRAMENTA | QTY |
|------------------------------|-----|
| BUSSOLA 6MA X 10 FORO DIAM.8 | 3 |

| LOCALE | CODICE | DESCRIZIONE COMPONENTE | FINITURA | GR. |
|------------|------------|--------------------------------|---------------|-----|
| PARATIE LD | MD320_PR22 | PARATIA CABINA VIP DX_SX POPPA | OKUME' GREZZO | 3 |

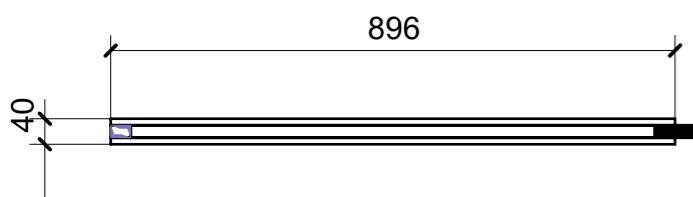
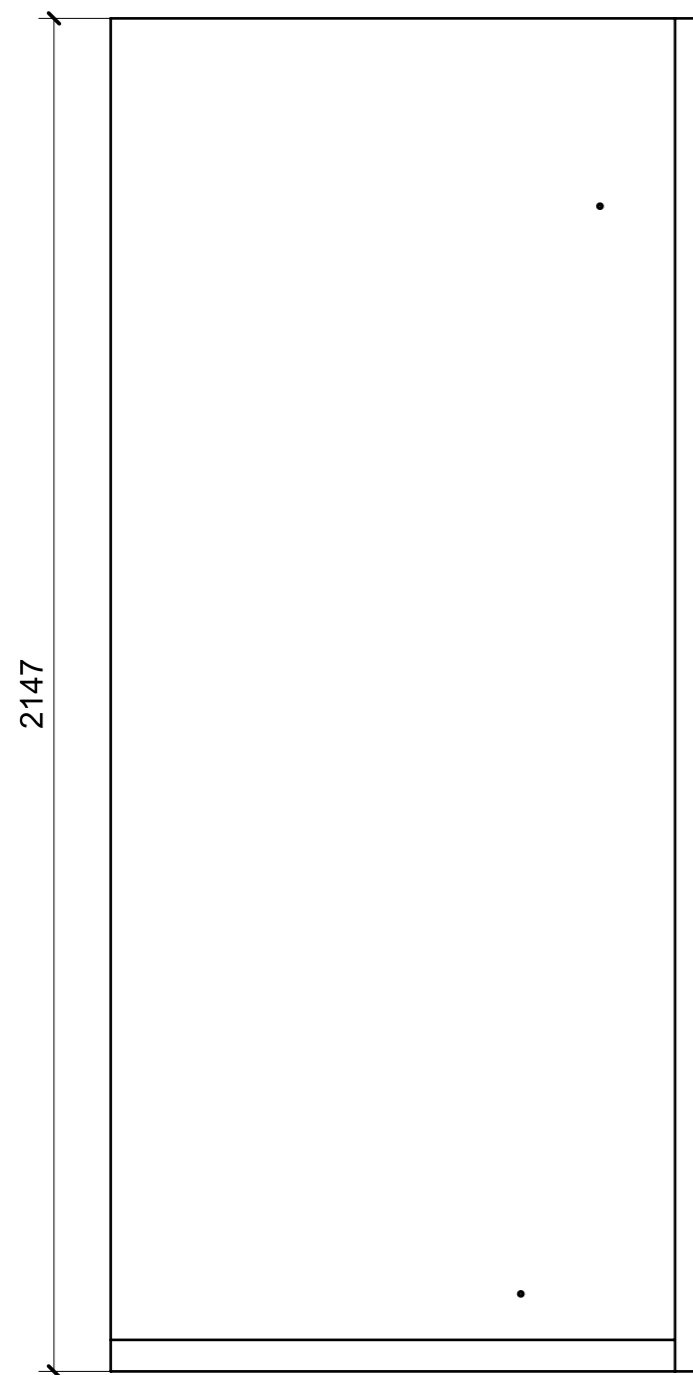

01

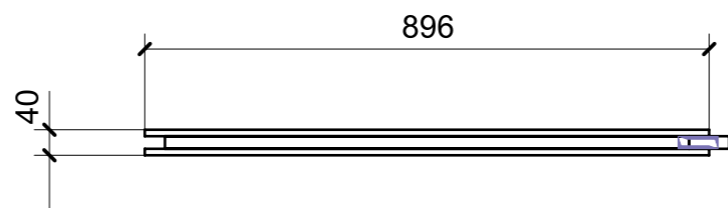
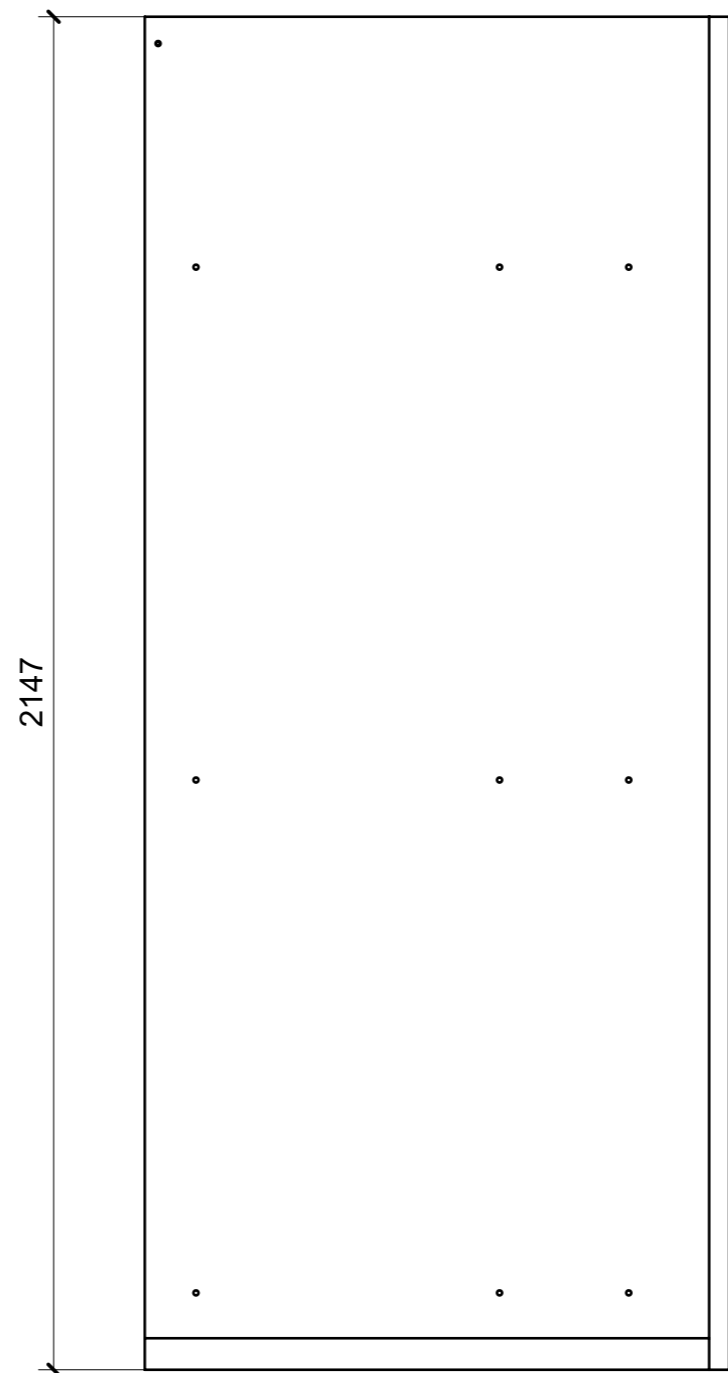

02

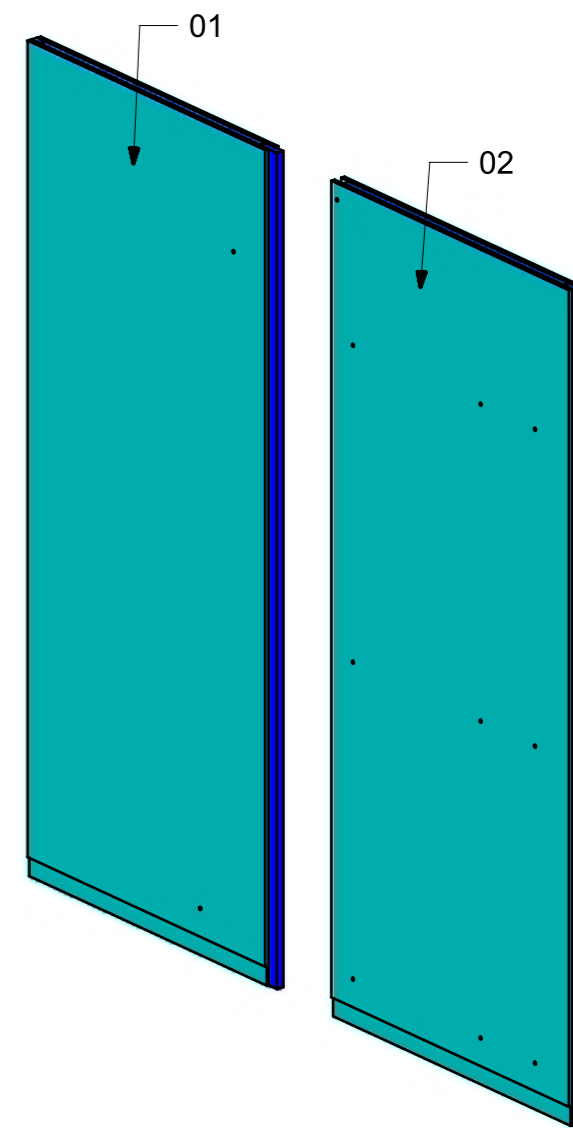

| FERRAMENTA | QTY |
|------------------------------|-----|
| BUSSOLA 6MA X 10 FORO DIAM.8 | 6 |

| LOCALE | CODICE | DESCRIZIONE COMPONENTE | FINITURA | GR. |
|------------|------------|-------------------------------|--------------------|-----|
| PARATIE LD | MD320_PR23 | PARATIA CABINA VIP DX_SX PRUA | LARICROSS / OKUME' | 3 |

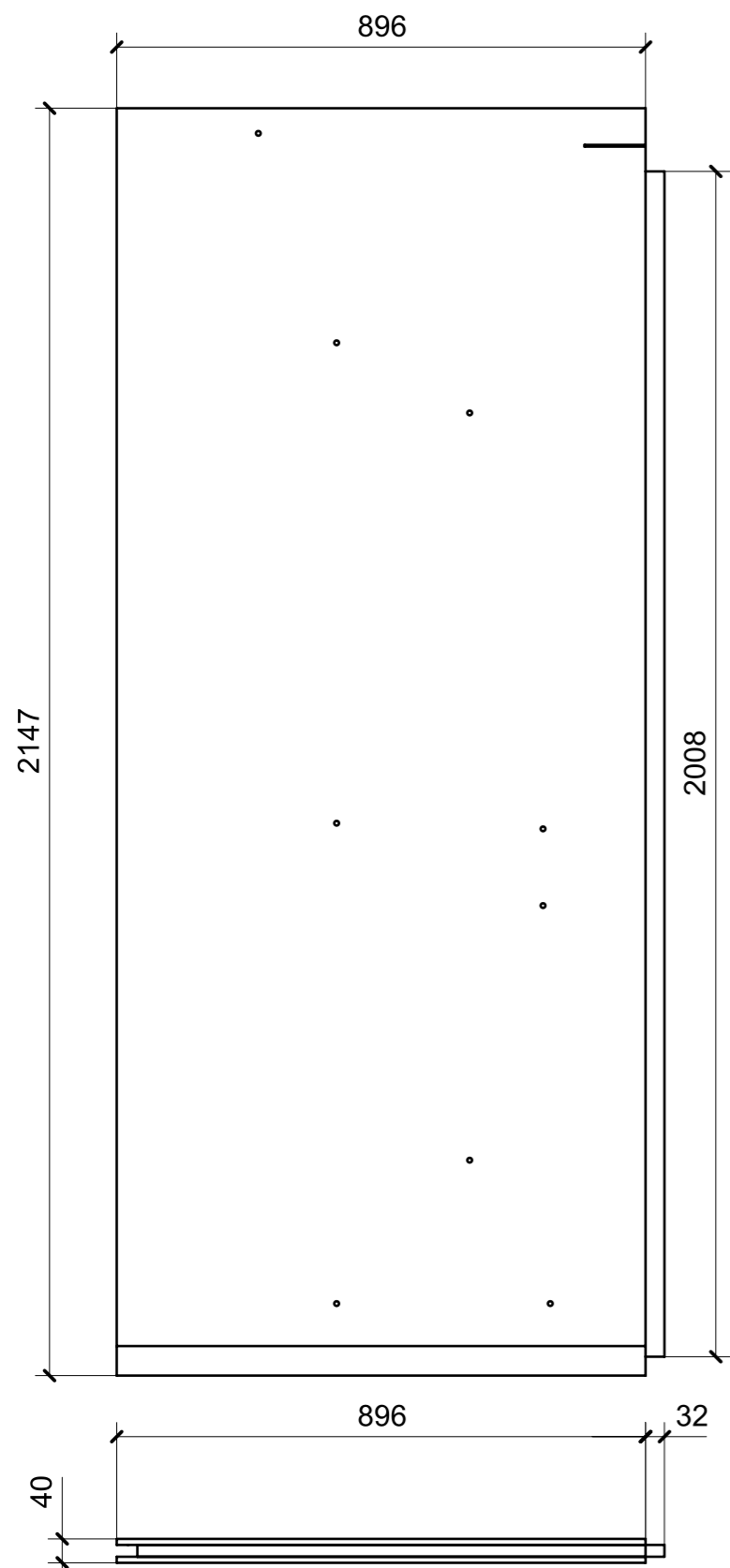

01

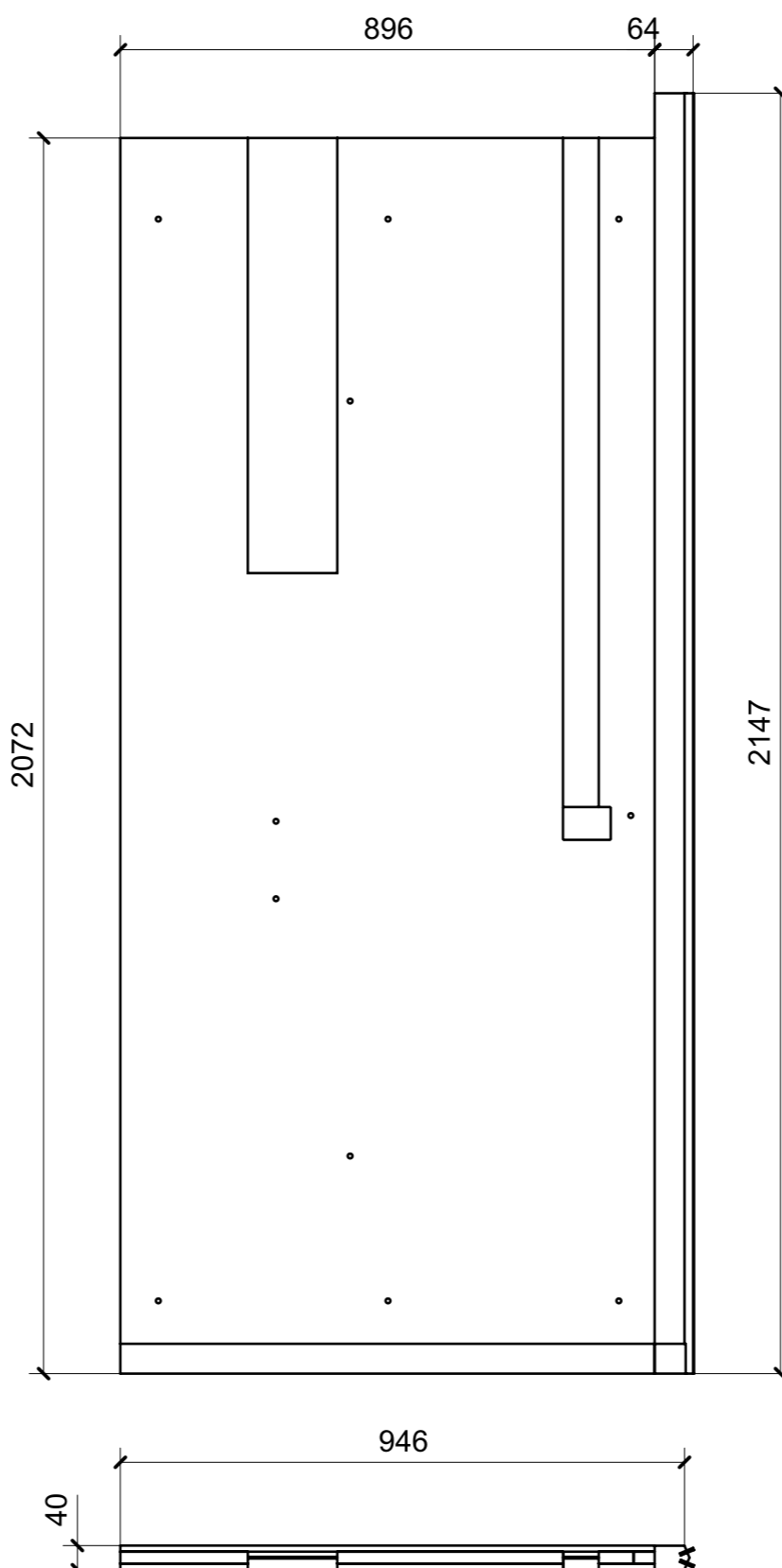

02

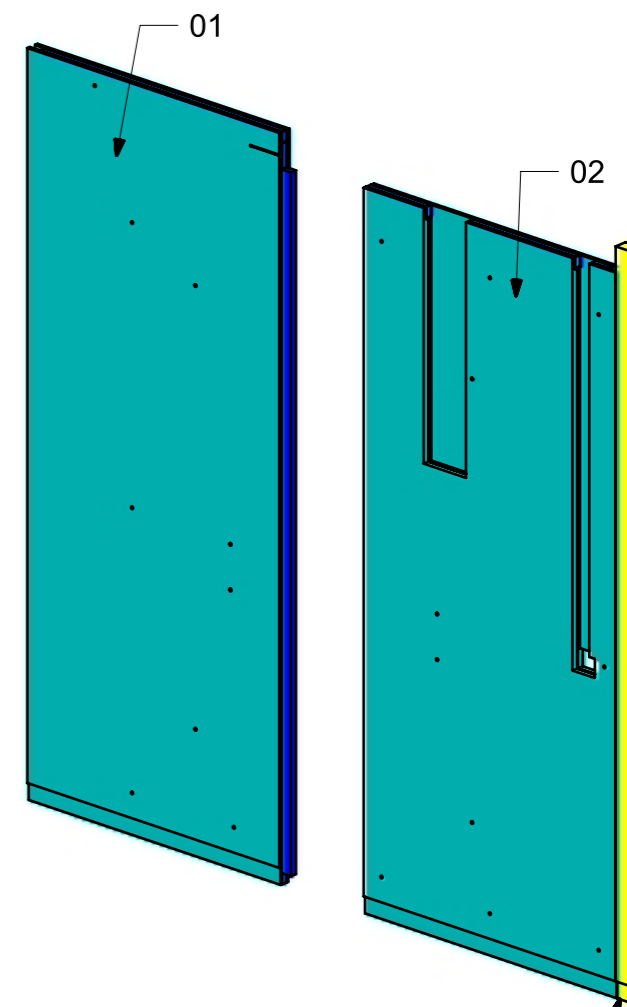

OKUME' GREZZO

| FERRAMENTA | QTY |
|------------------------------|-----|
| BUSSOLA 6MA X 10 FORO DIAM.8 | 18 |

| LOCALE | CODICE | DESCRIZIONE COMPONENTE | FINITURA | GR. |
|------------|------------|-----------------------------|---------------|-----|
| PARATIE LD | MD320_PR24 | PARATIA PORTA CABINA VIP DX | OKUME' GREZZO | 2 |

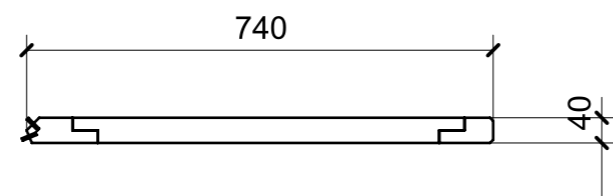
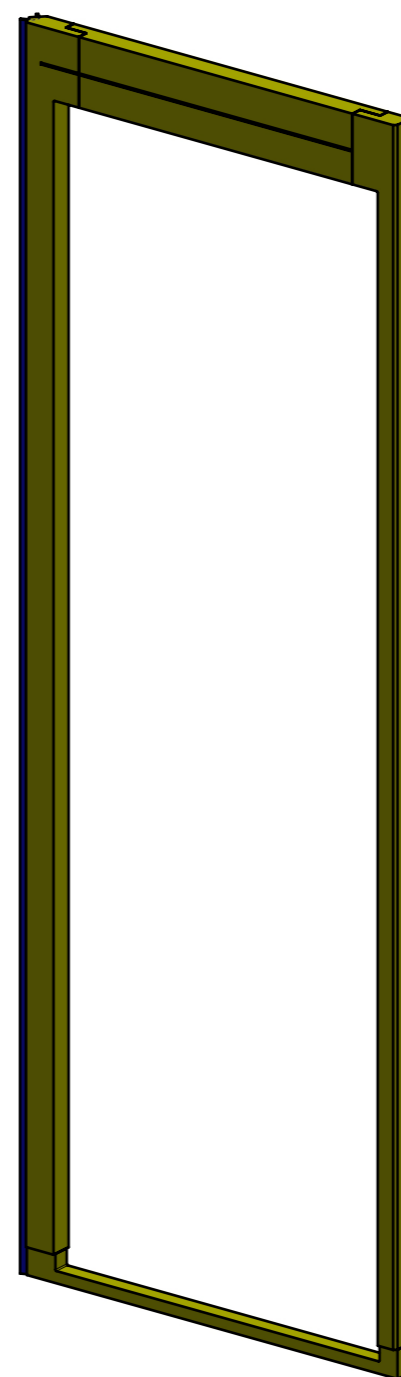
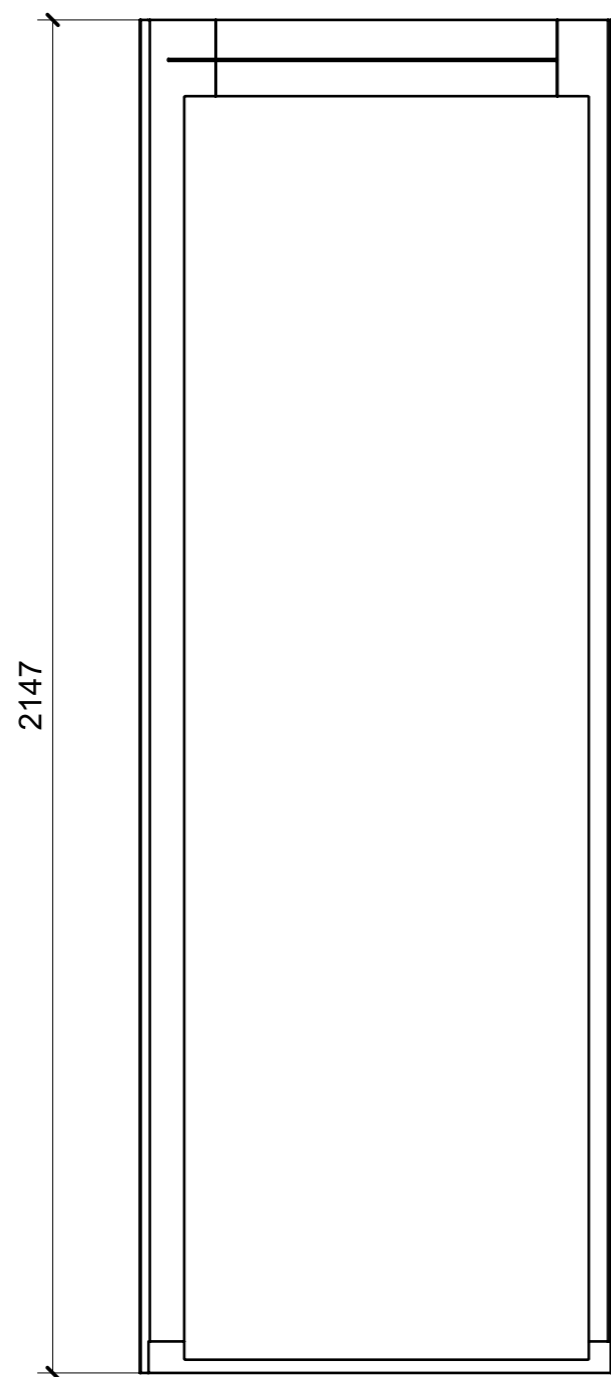

01

| LOCALE | CODICE | DESCRIZIONE COMPONENTE | FINITURA | GR. |
|------------|------------|-----------------------------|---------------|-----|
| PARATIE LD | MD320_PR25 | PARATIA PORTA CABINA VIP SX | OKUME' GREZZO | PTP |

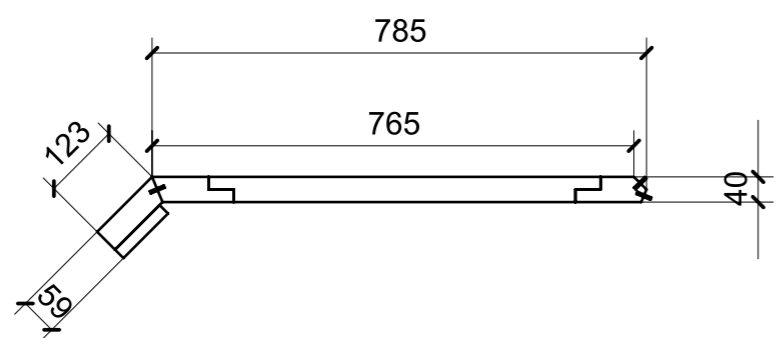
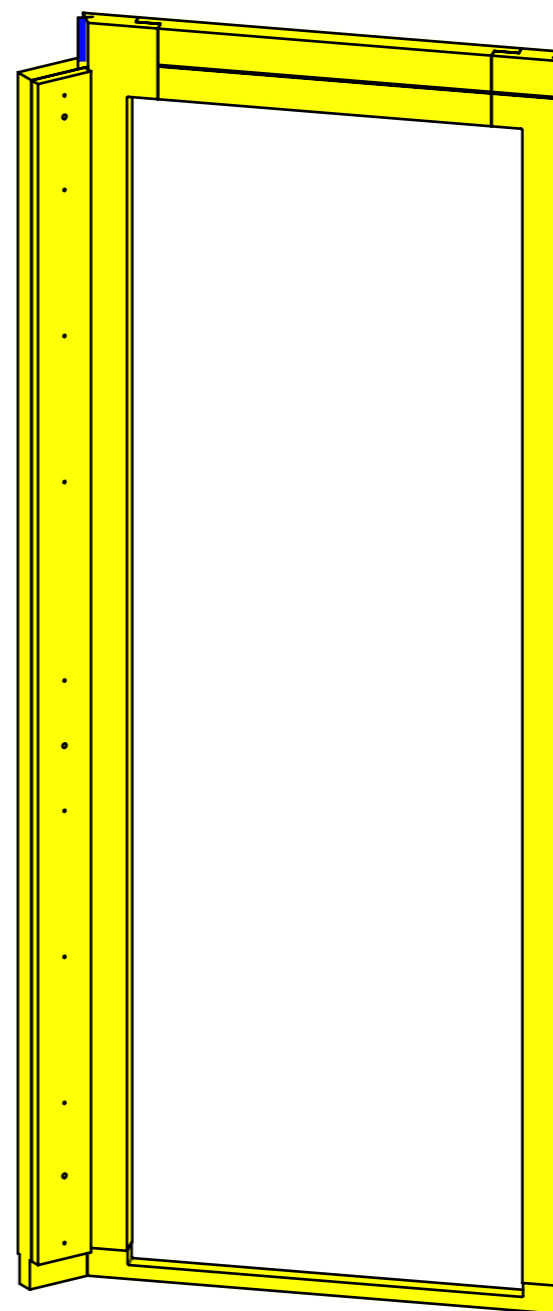
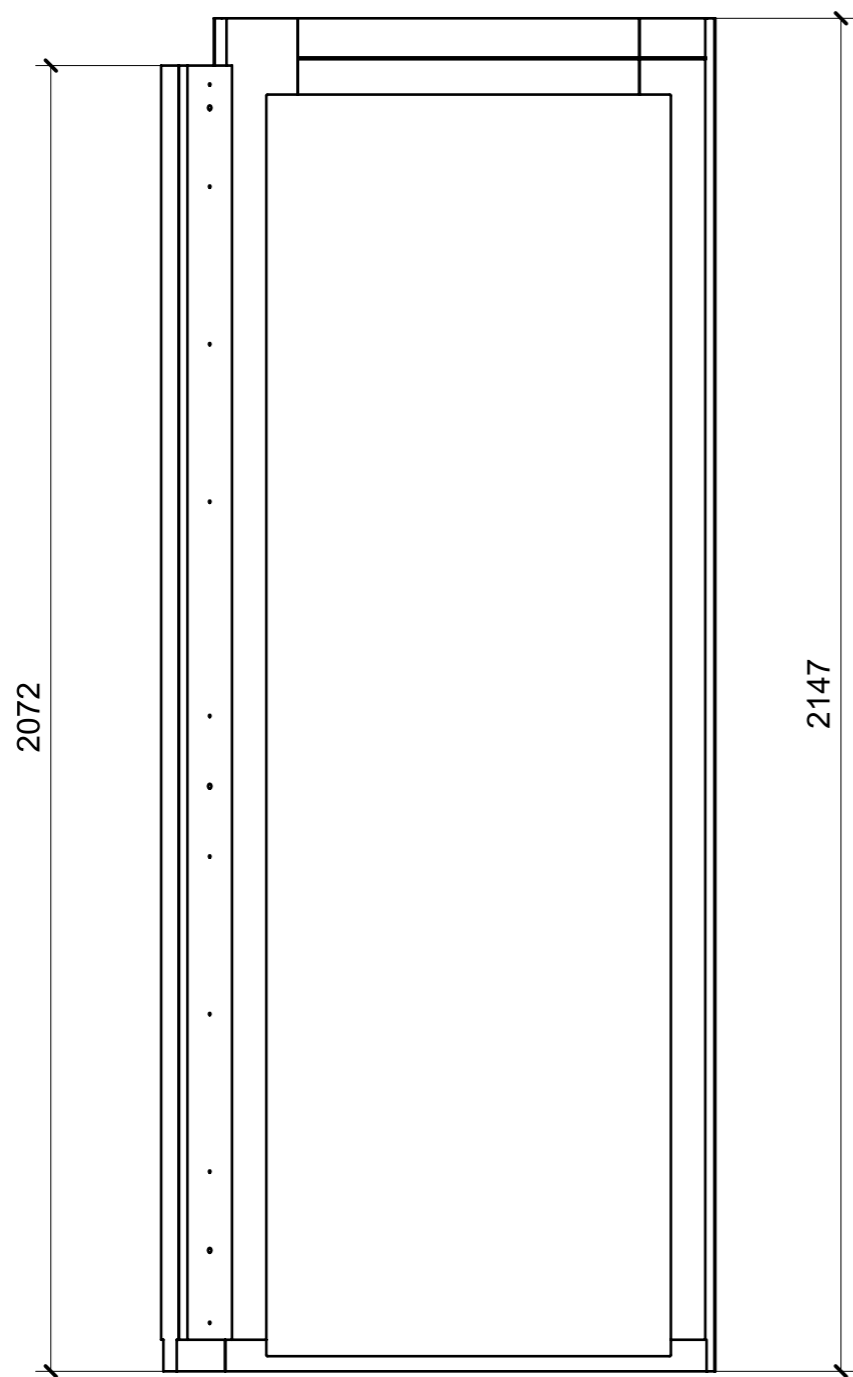

01

| LOCALE | CODICE | DESCRIZIONE COMPONENTE | FINITURA | GR. |
|------------|------------|------------------------|---------------|-----|
| PARATIE LD | MD320_PR26 | PARATIA STRUTTURALE DX | OKUME' GREZZO | PTP |

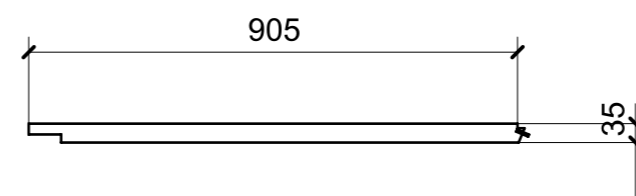
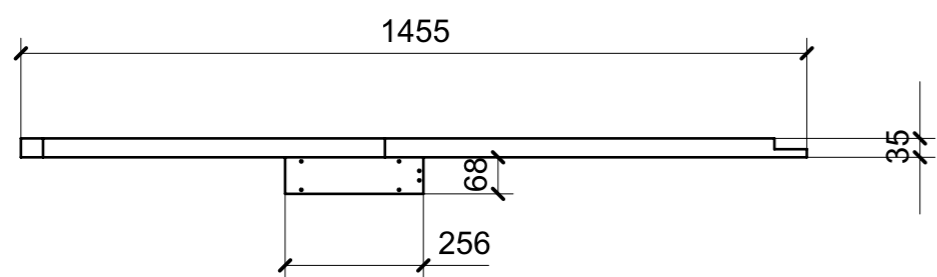
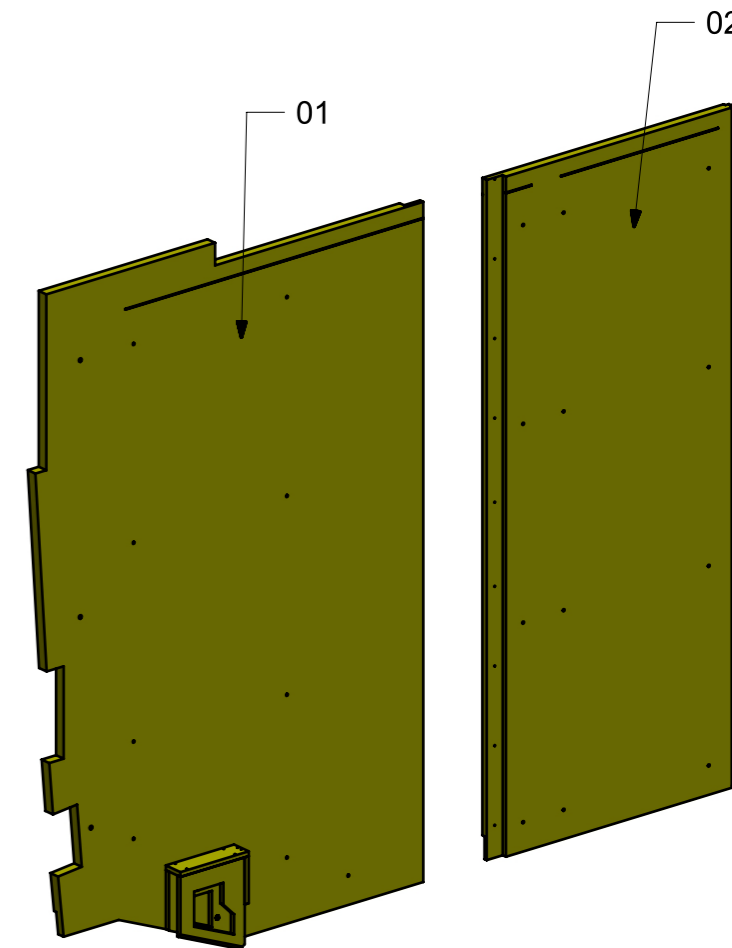
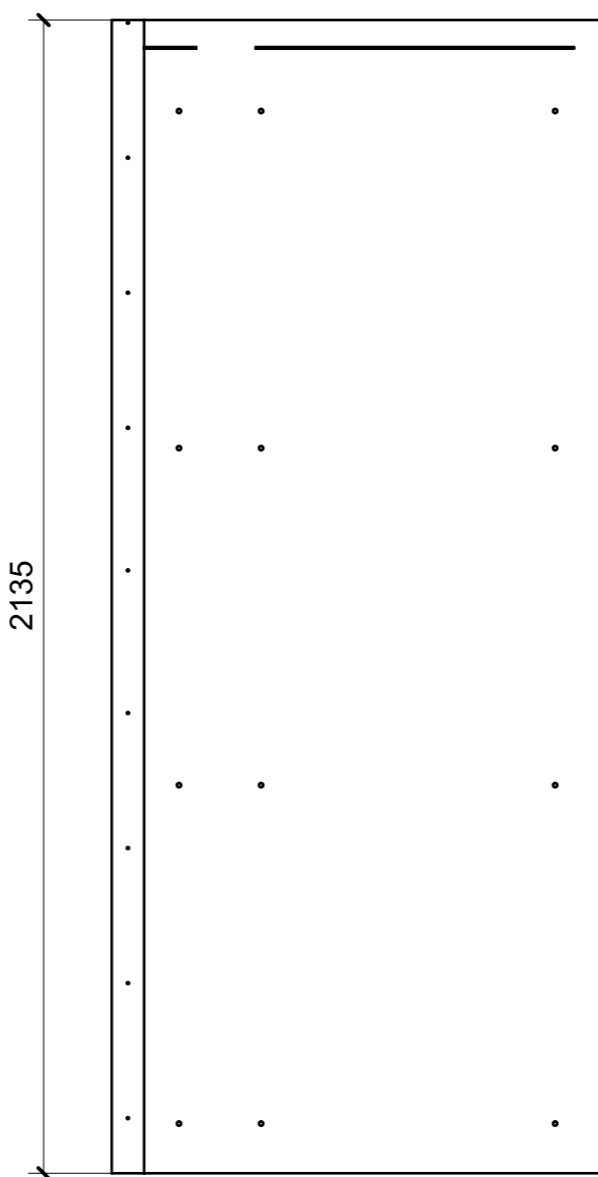
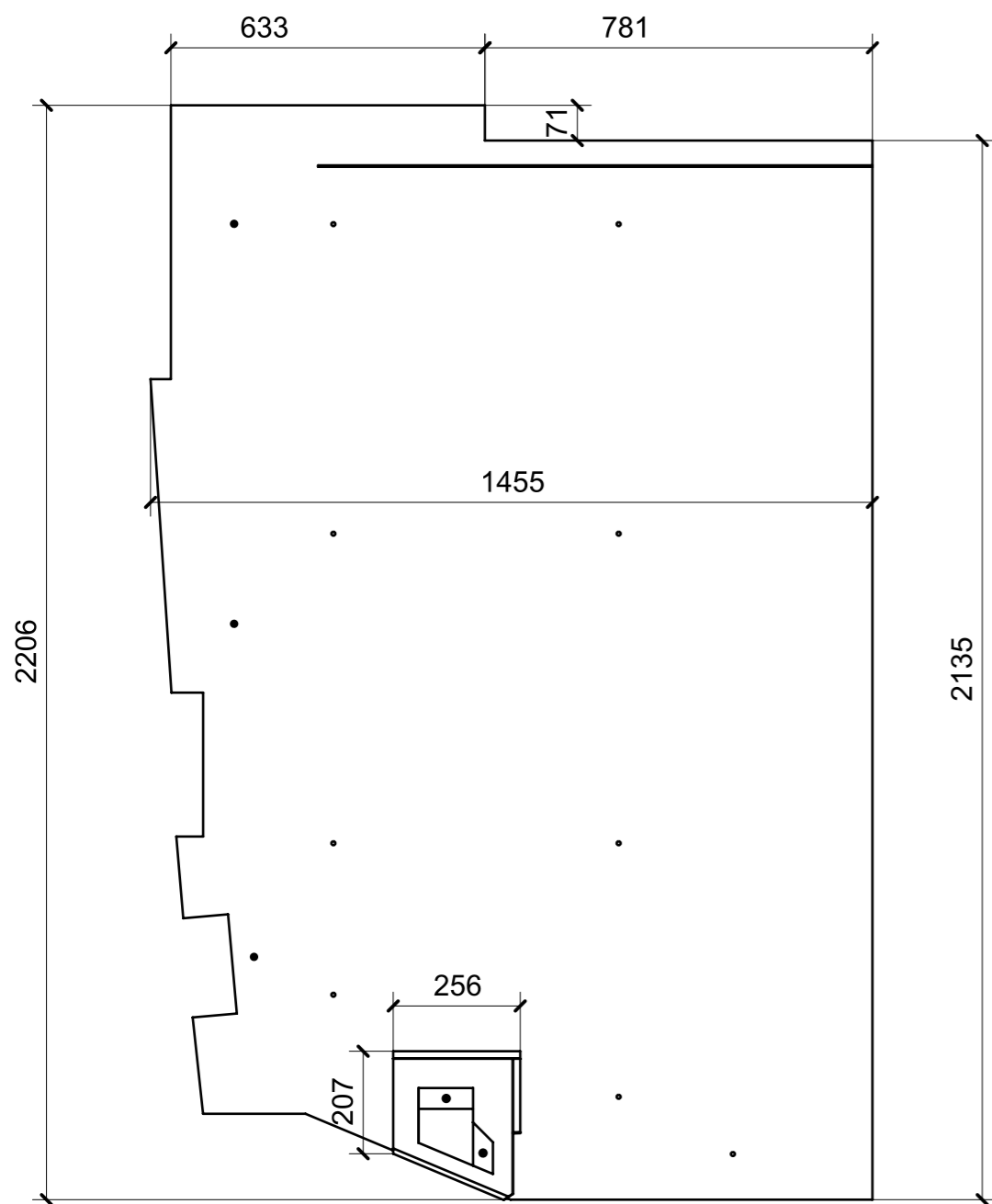

01

02

| FERRAMENTA | QTY |
|------------------------------|-----|
| VITE 6MA X 25 TESTA BOMBATA | 2 |
| BUSSOLA 6MA X 10 FORO DIAM.8 | 7 |

| LOCALE | CODICE | DESCRIZIONE COMPONENTE | FINITURA | GR. |
|------------|------------|------------------------|---------------|-----|
| PARATIE LD | MD320_PR27 | PARATIA STRUTTURALE SX | OKUME' GREZZO | 2 |

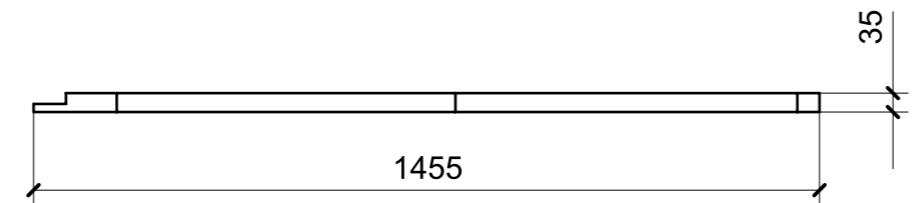
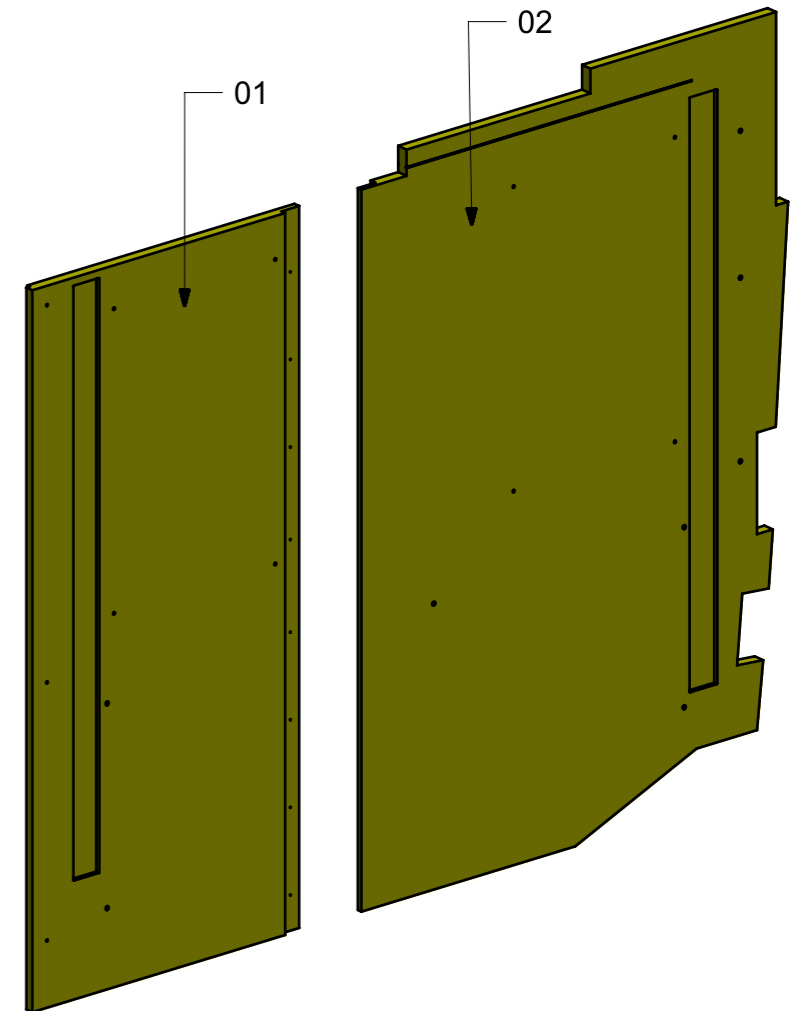
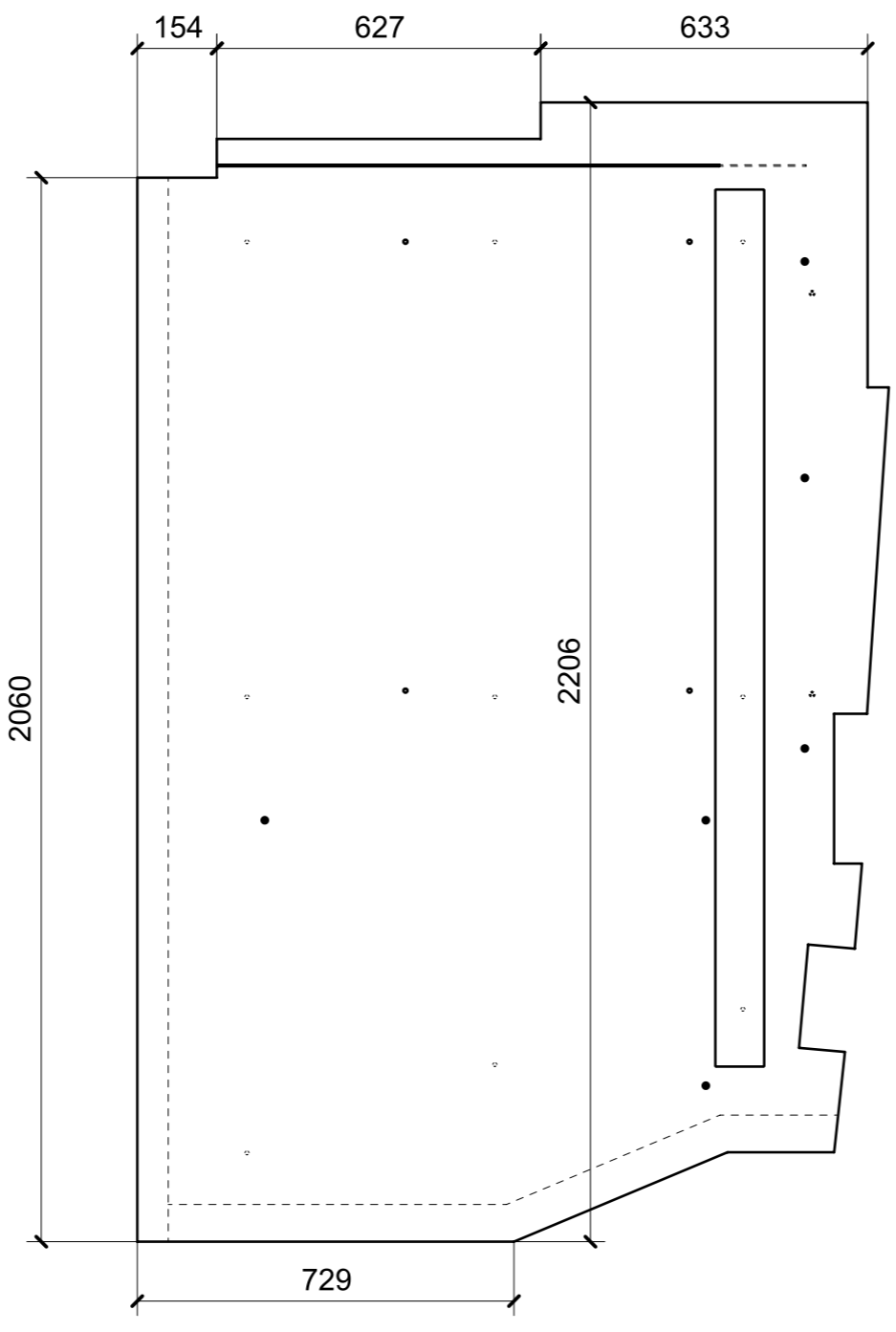
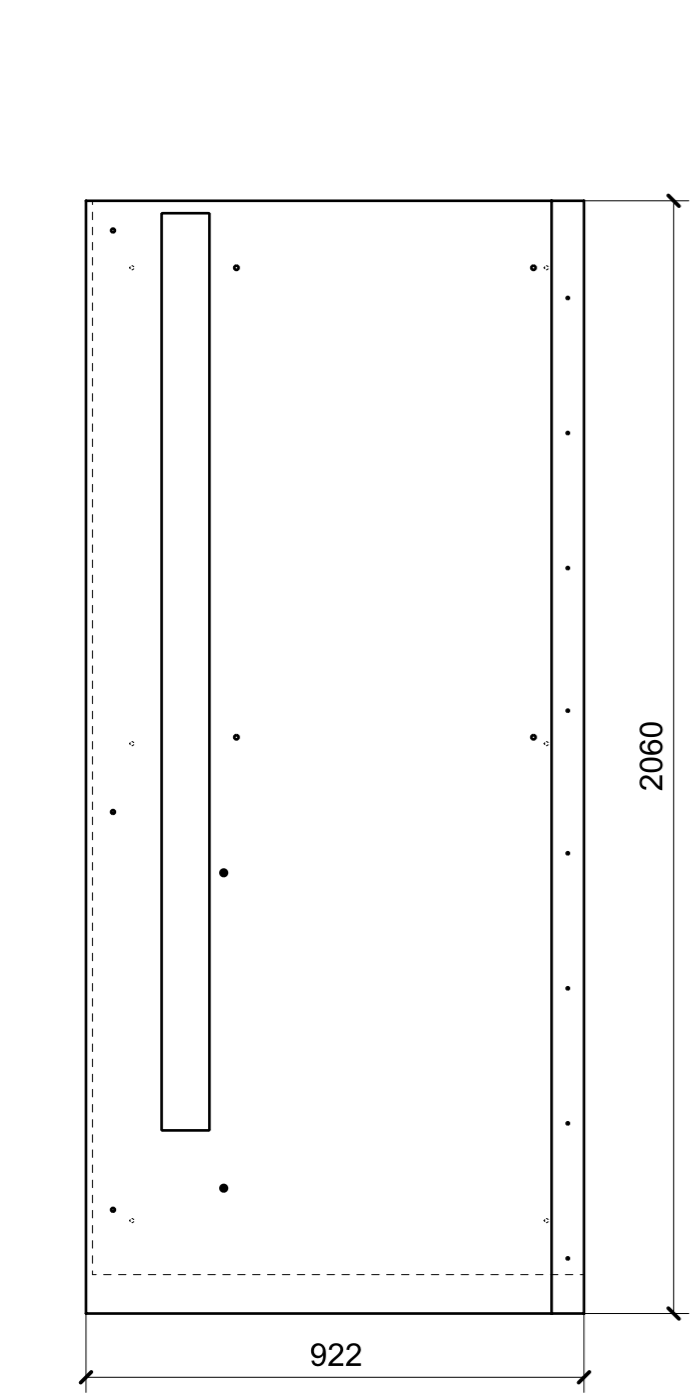

01

02

| FERRAMENTA | QTY |
|------------------------------|-----|
| BUSSOLA 6MA X 10 FORO DIAM.8 | 10 |

| LOCALE | CODICE | DESCRIZIONE COMPONENTE | FINITURA | GR. |
|------------|------------|--------------------------------------|-------------------------|-----|
| PARATIE LD | MD320_PR28 | PARATIA CABINA OSPITI_LOBBY DX POPPA | LARICROSS/OKUME' GREZZO | 2 |

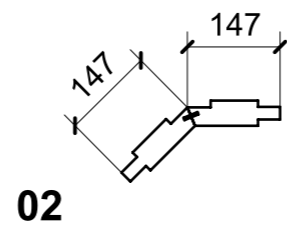
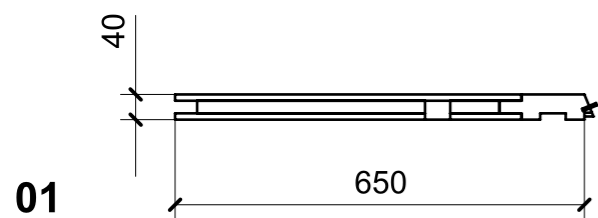
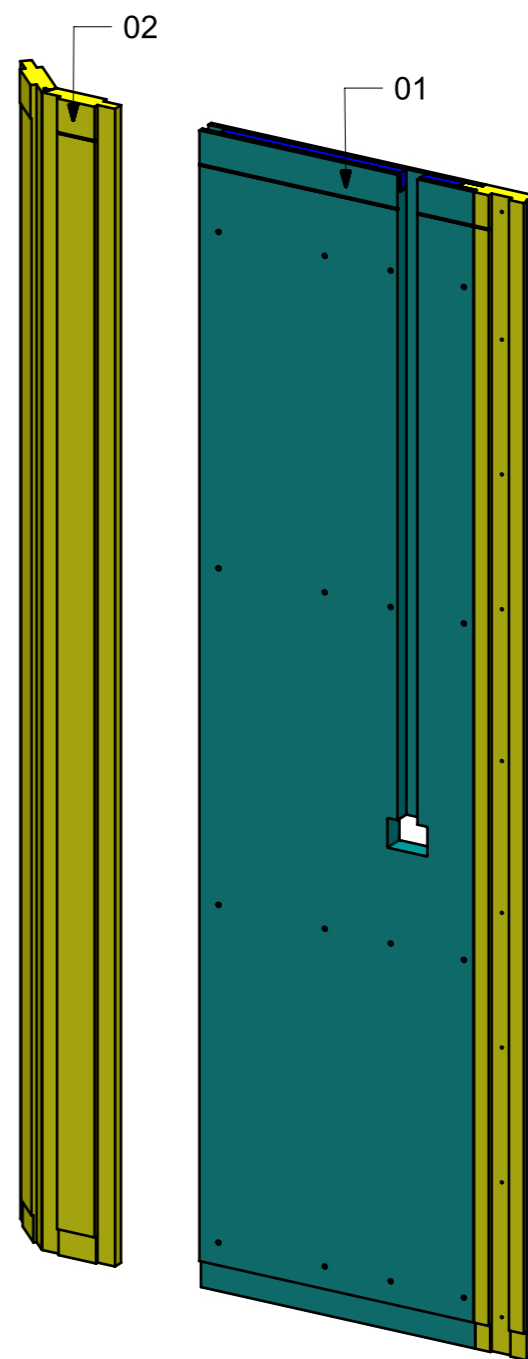
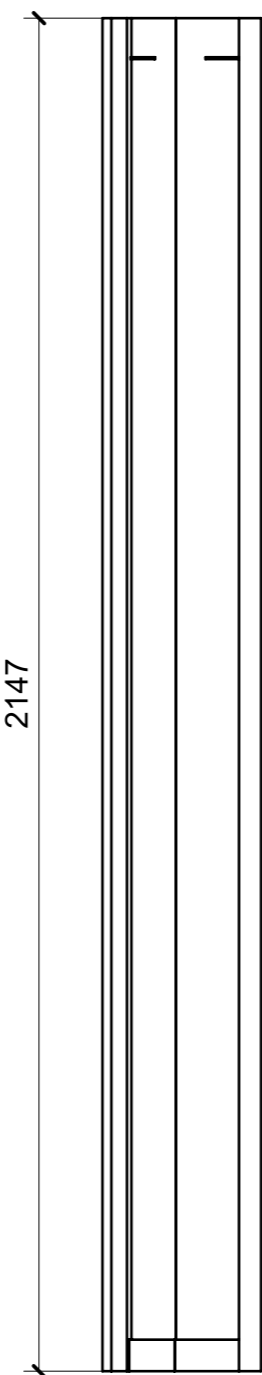
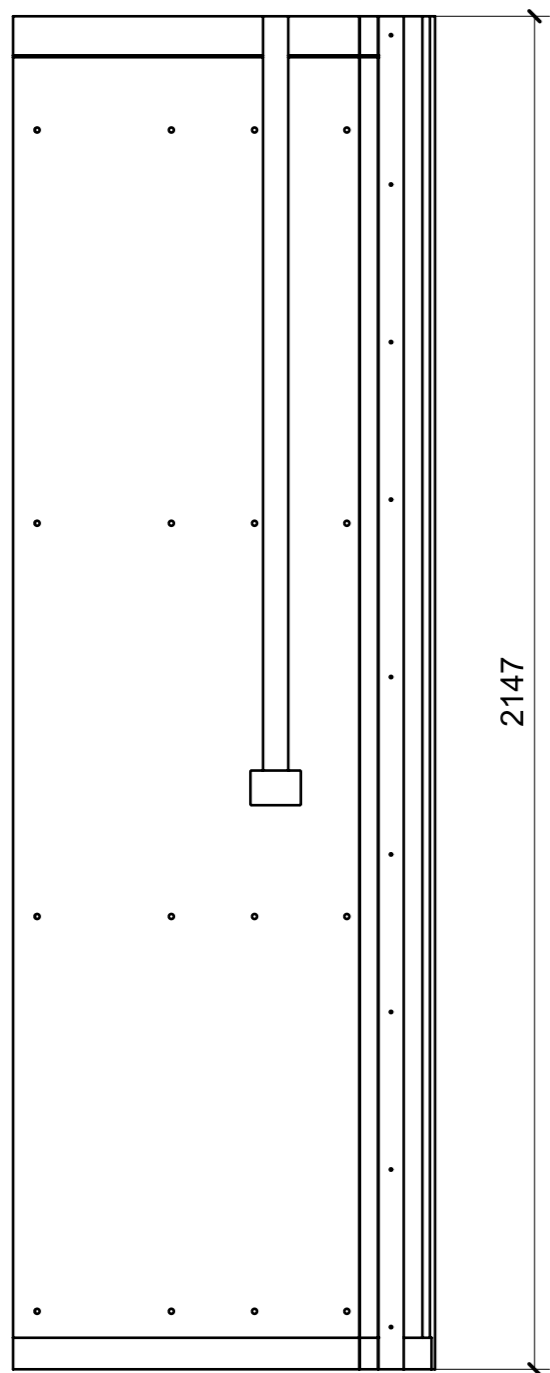

| LOCALE | CODICE | DESCRIZIONE COMPONENTE | FINITURA | GR. |
|------------|------------|-----------------------------------|-------------------------|-----|
| PARATIE LD | MD320_PR29 | PARATIA TV CABINA OSPITI_LOBBY DX | LARICROSS/OKUME' GREZZO | 2 |

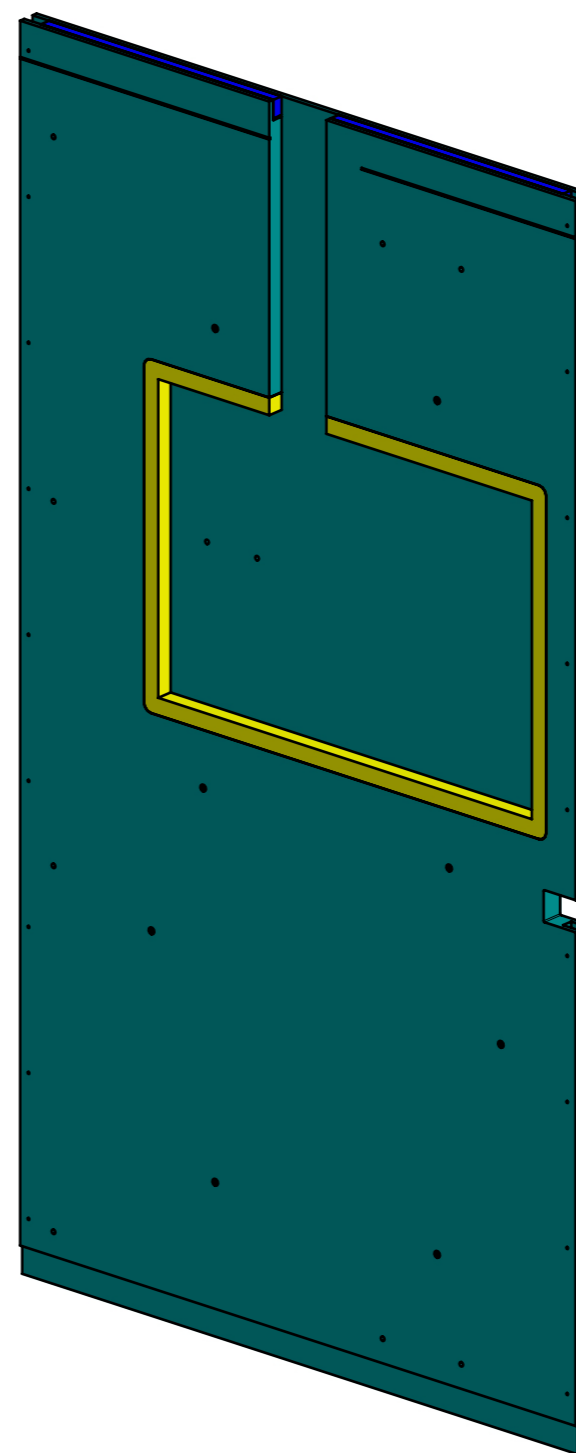
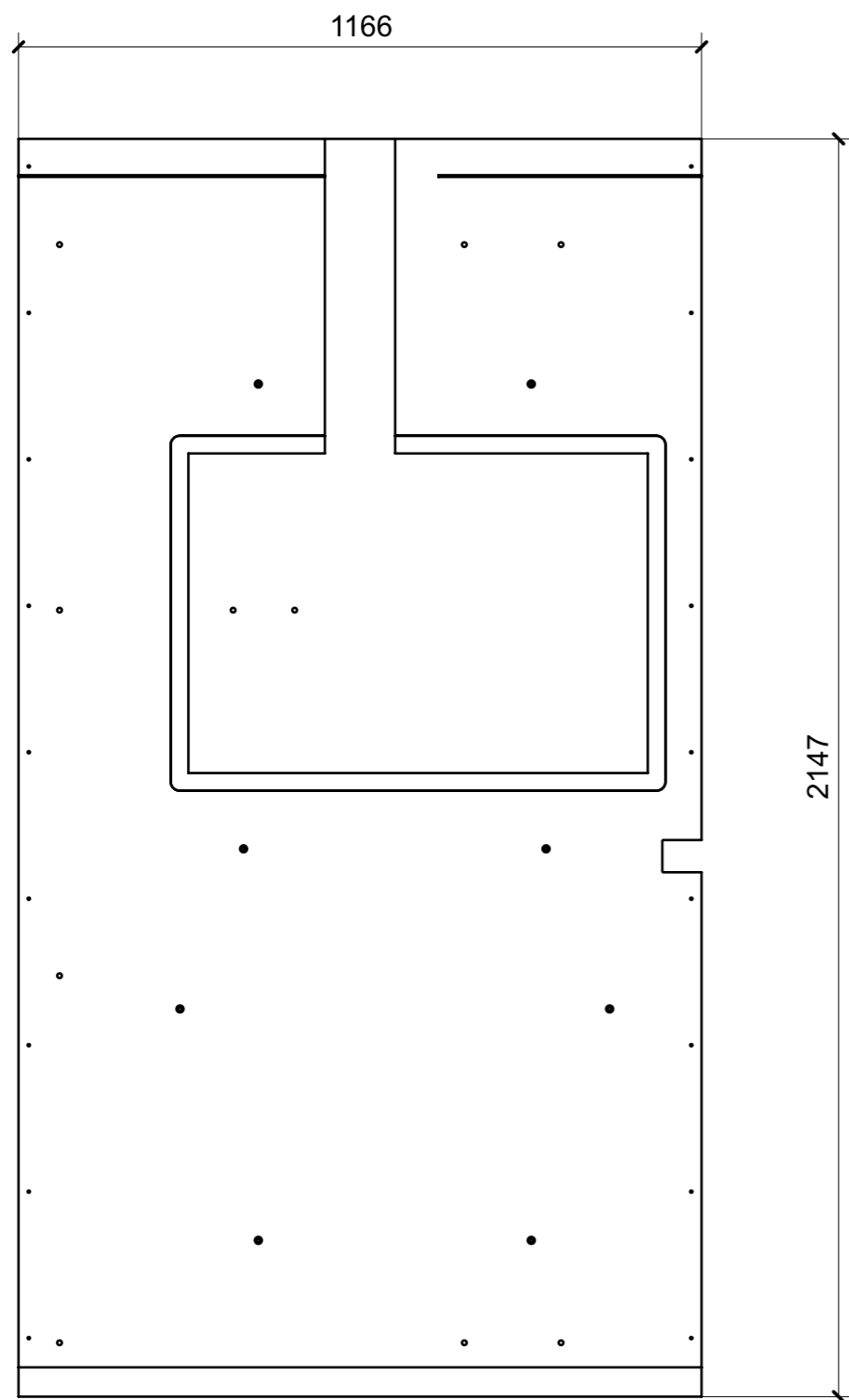

01

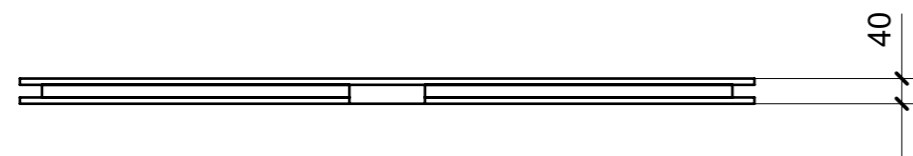

| FERRAMENTA | QTY |
|------------------------------|-----|
| BUSSOLA 6MA X 10 FORO DIAM.8 | 8 |

| LOCALE | CODICE | DESCRIZIONE COMPONENTE | FINITURA | GR. |
|------------|------------|--------------------------------------|---------------|-----|
| PARATIE LD | MD320_PR30 | PARATIA PORTA CABINA OSPITI_LOBBY DX | OKUME' GREZZO | PTP |

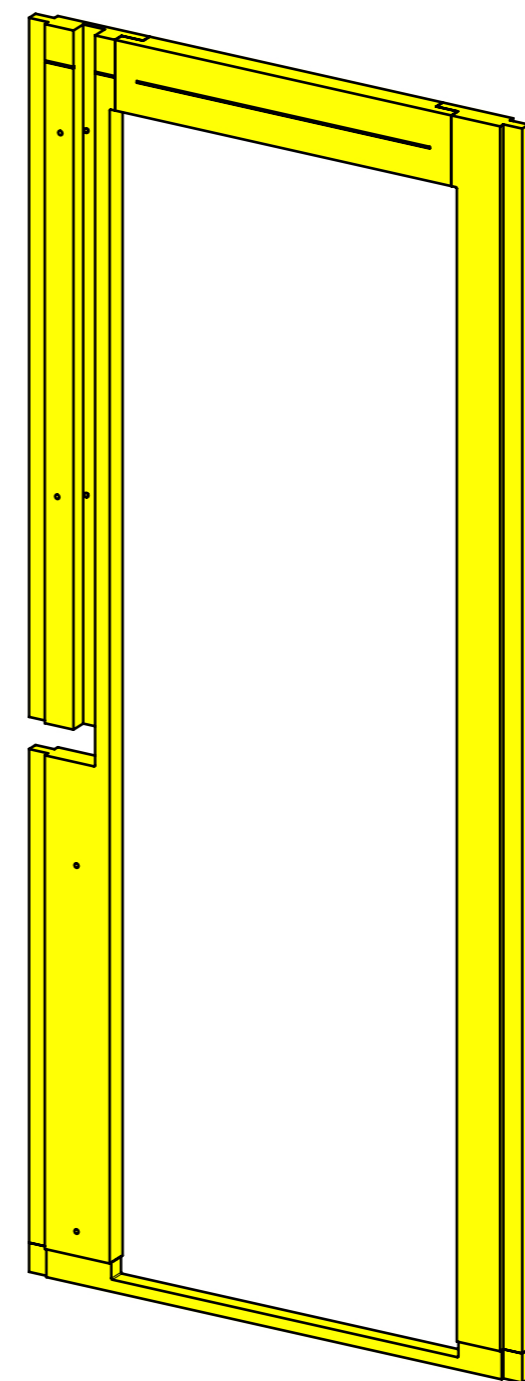
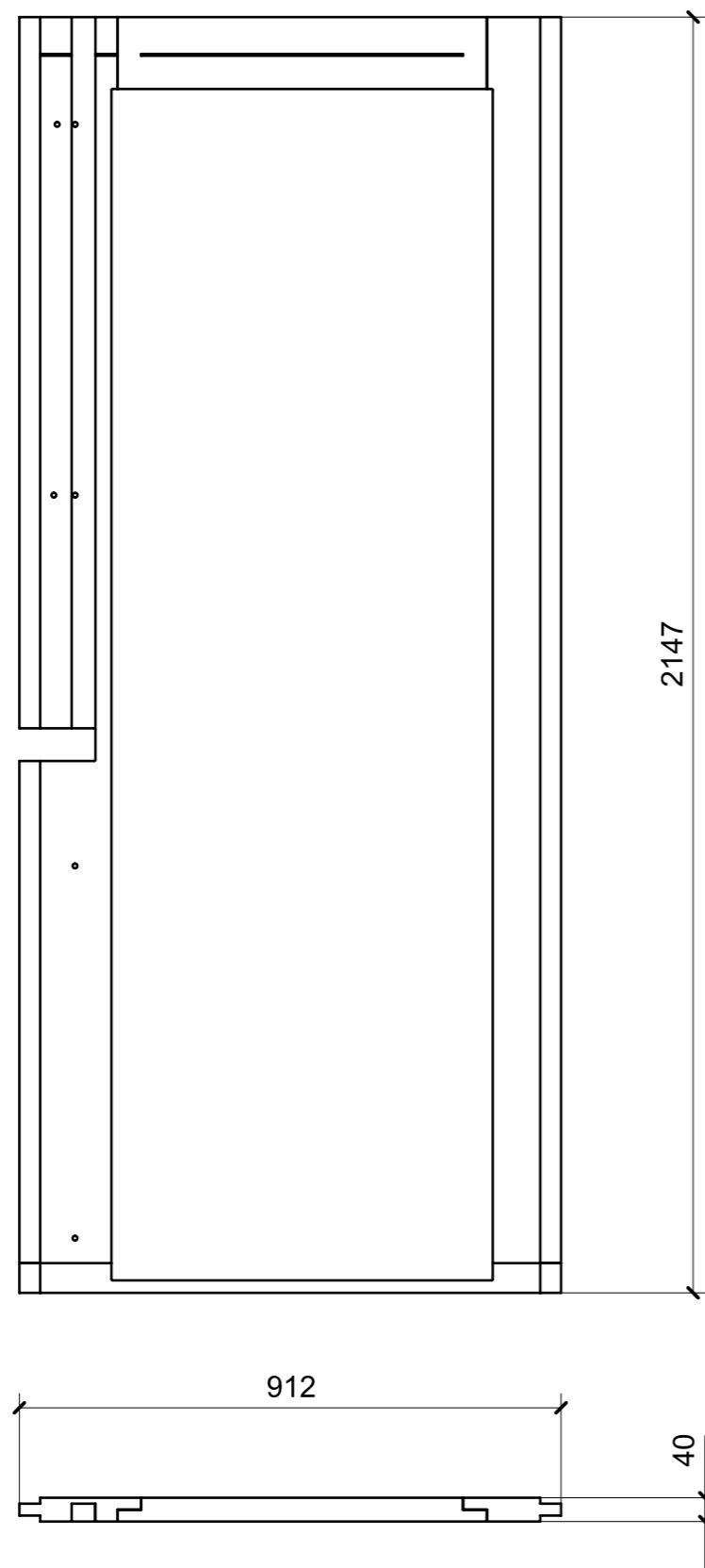

| LOCALE | CODICE | DESCRIZIONE COMPONENTE | FINITURA | GR. |
|------------|------------|--------------------------------------|-------------------------|-----|
| PARATIE LD | MD320_PR31 | PARATIA PORTA CABINA OSPITI SX POPPA | LARICROSS/OKUME' GREZZO | 2 |

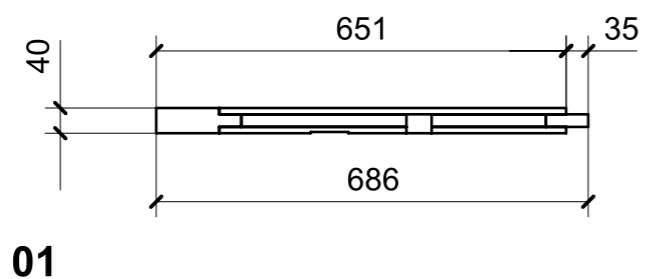
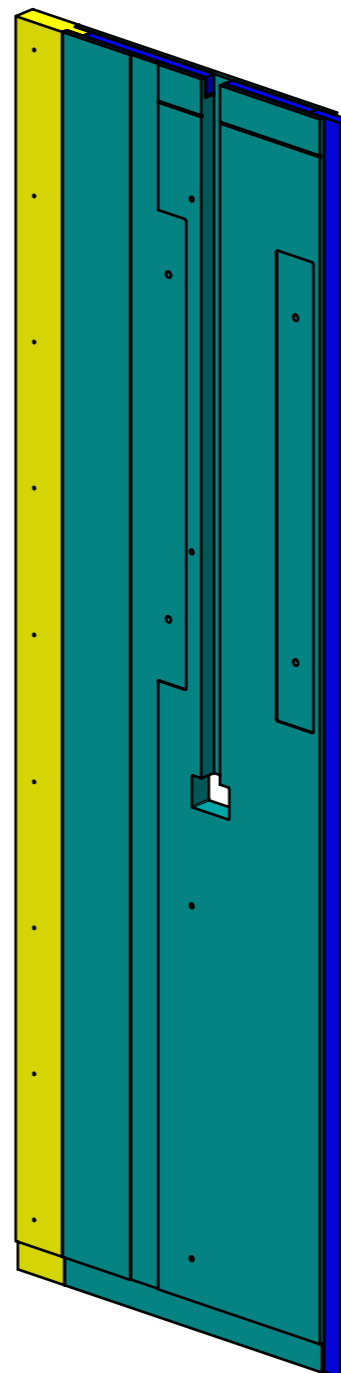
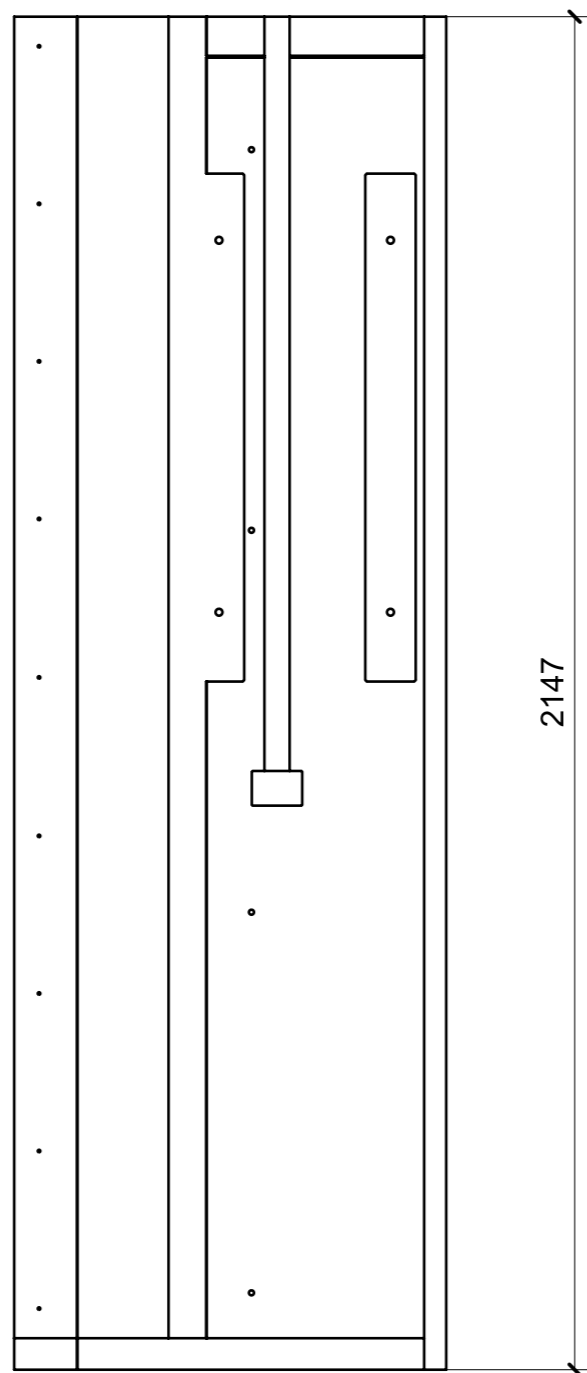

| LOCALE | CODICE | DESCRIZIONE COMPONENTE | FINITURA | GR. |
|------------|------------|--------------------------------|-----------|-----|
| PARATIE LD | MD320_PR32 | PARATIA PORTA CABINA OSPITI SX | LARICROSS | 2 |

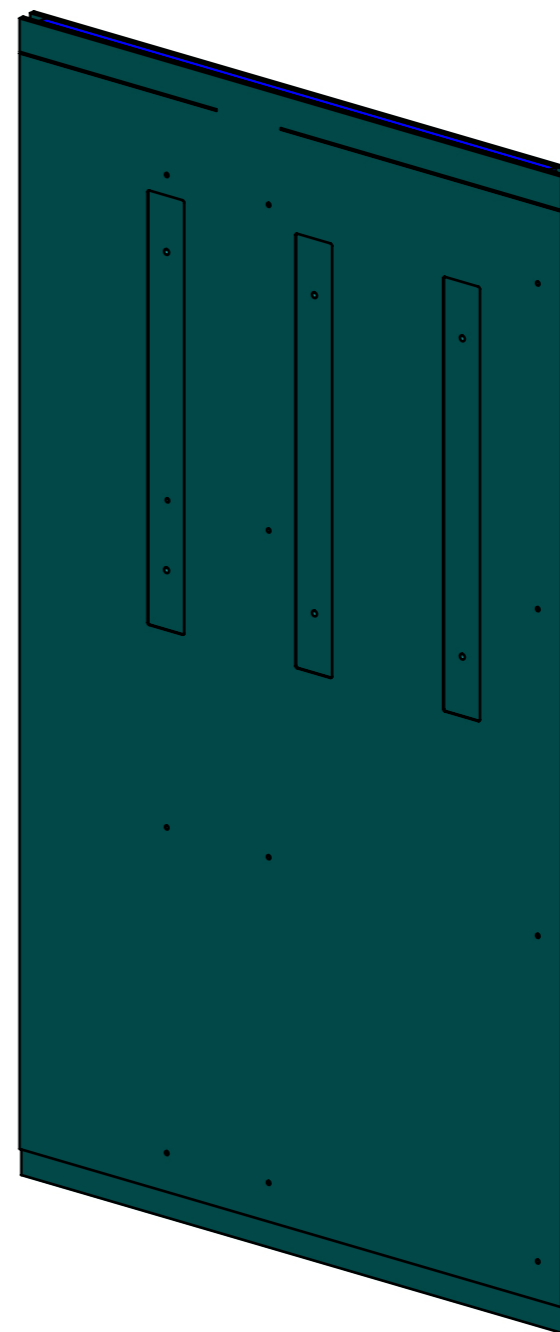
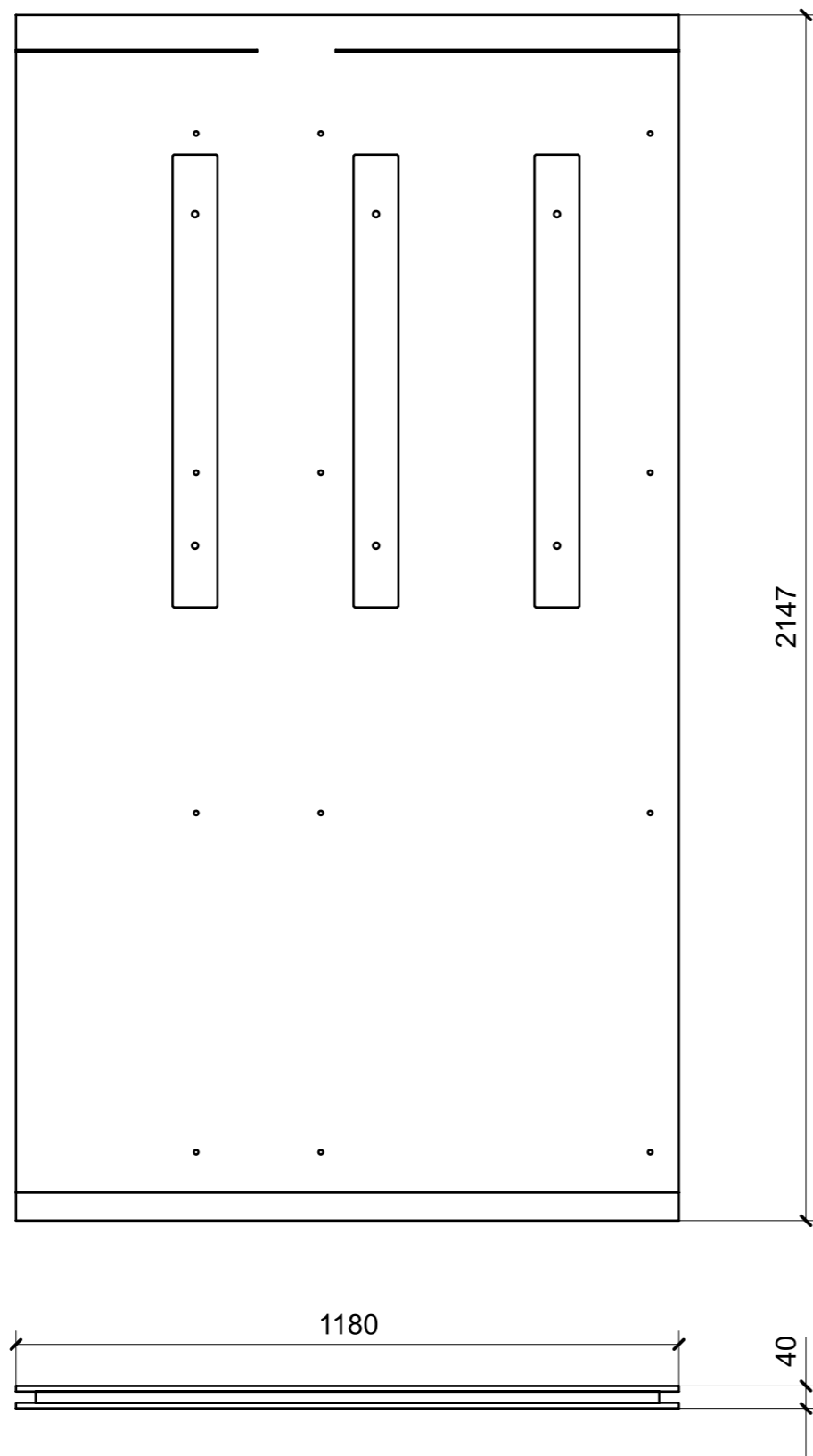

01

| LOCALE | CODICE | DESCRIZIONE COMPONENTE | FINITURA | GR. |
|------------|------------|--------------------------------|---------------|-----|
| PARATIE LD | MD320_PR33 | PARATIA PORTA CABINA OSPITI SX | OKUME' GREZZO | PTP |

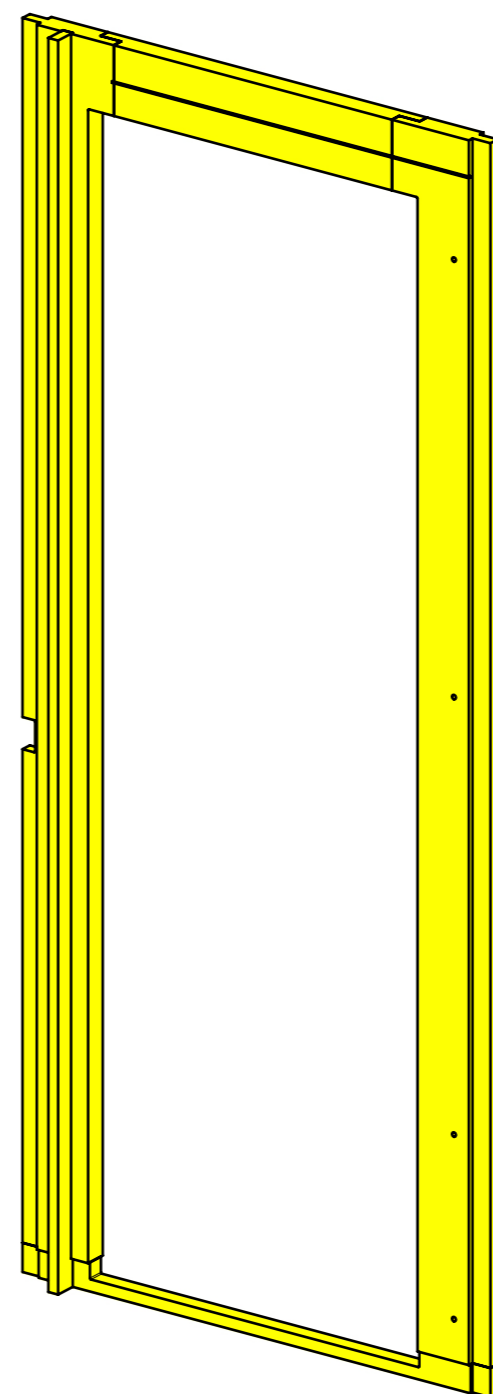
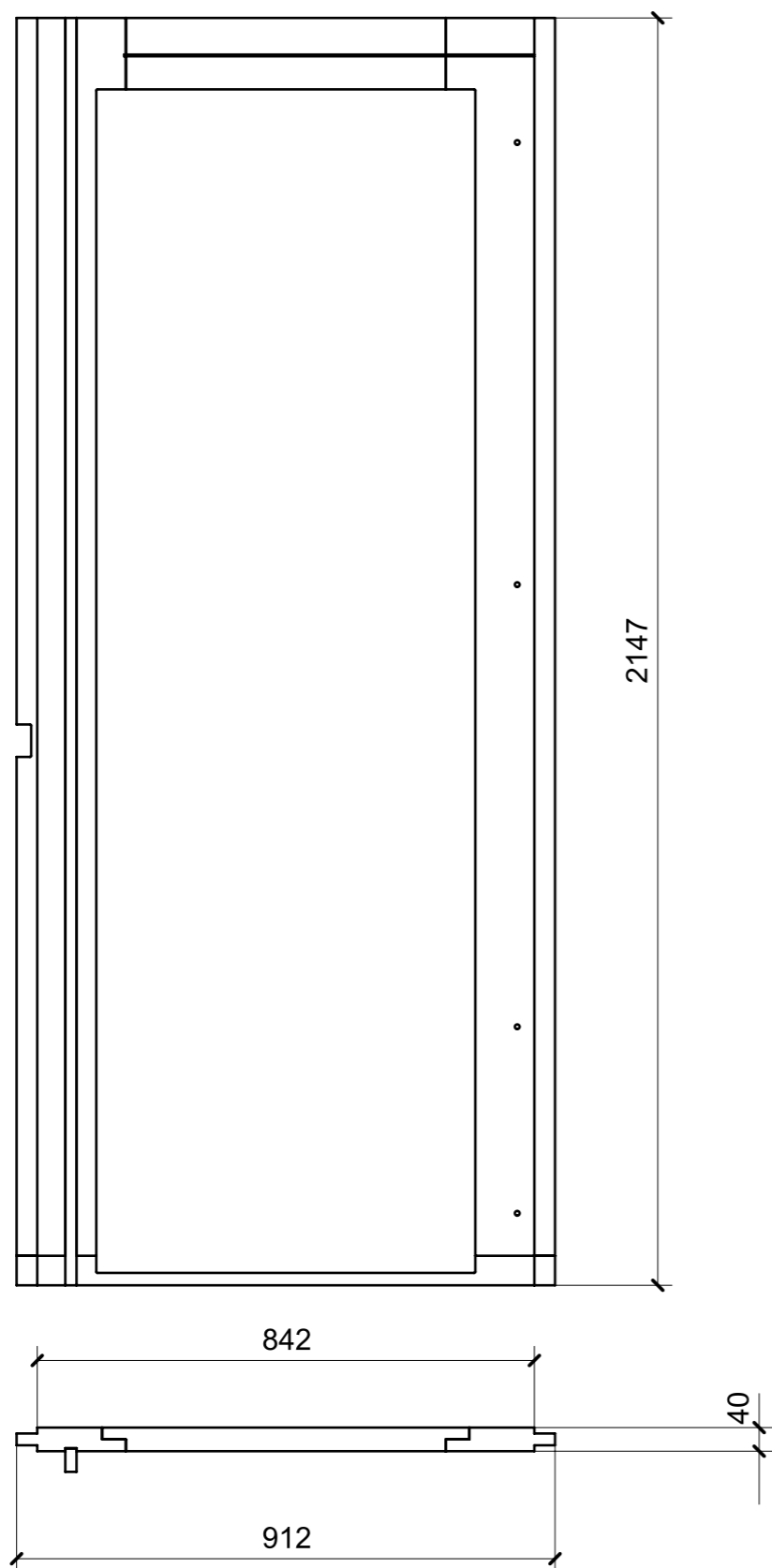

01

| LOCALE | CODICE | DESCRIZIONE COMPONENTE | FINITURA | GR. |
|------------|------------|-------------------------------|-------------------------|-----|
| PARATIE LD | MD320_PR34 | PARATIA PORTA BAGNO OSPITI SX | LARICROSS/OKUME' GREZZO | 4 |

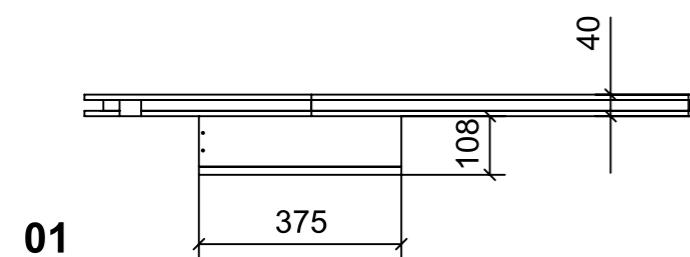
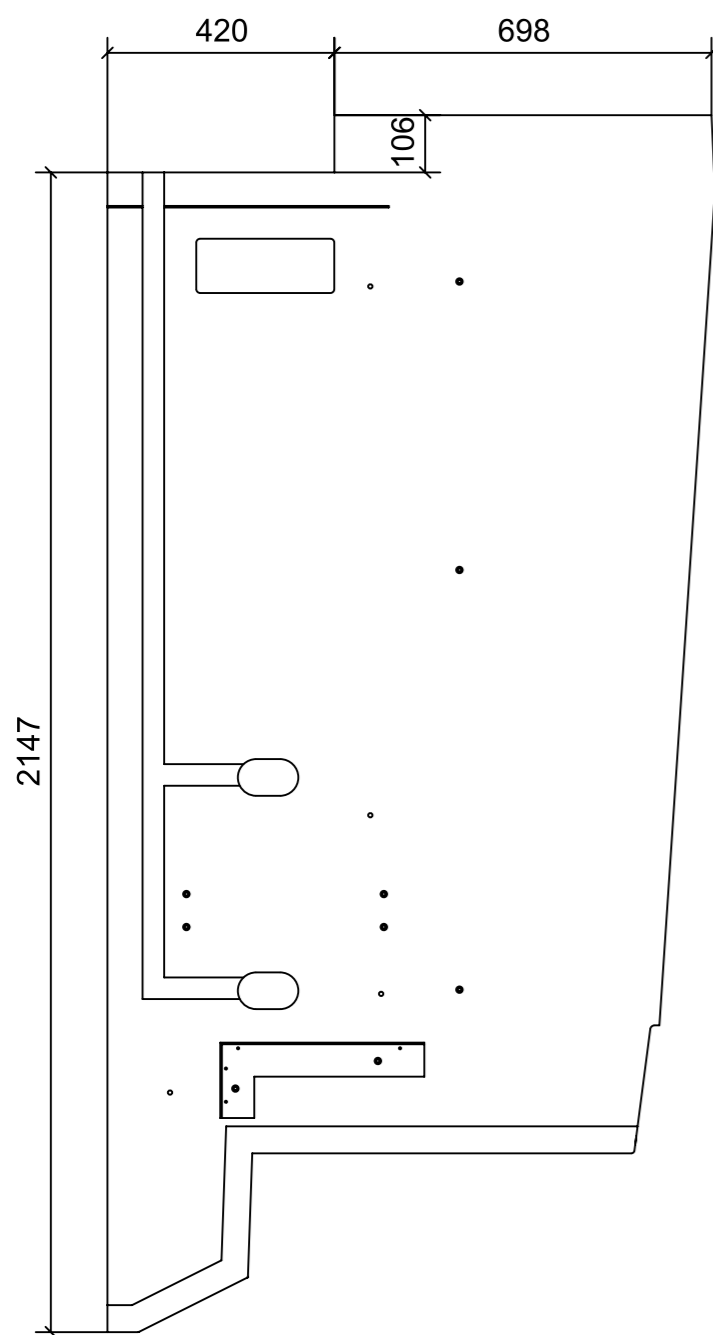

01
LARICROSS

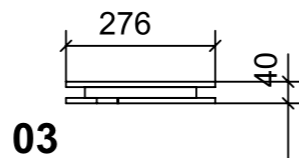
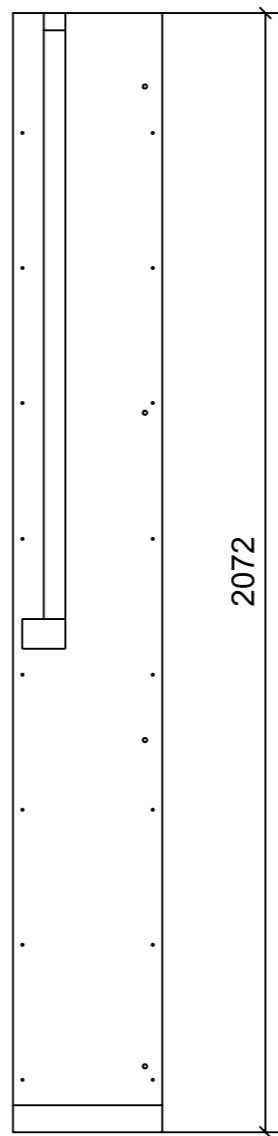

03
LARICROSS

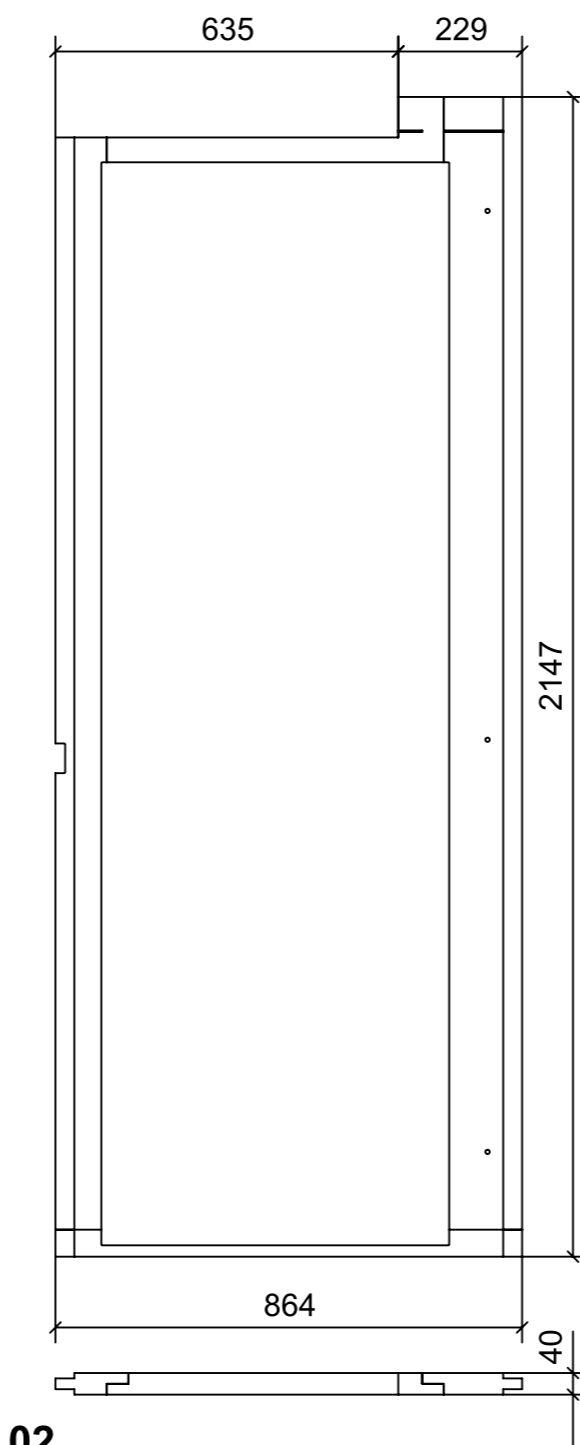

02
OKUME' GREZZO

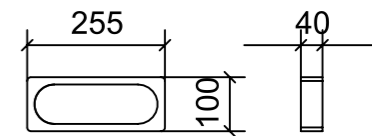

04
GREZZO
ANTI ROMBO

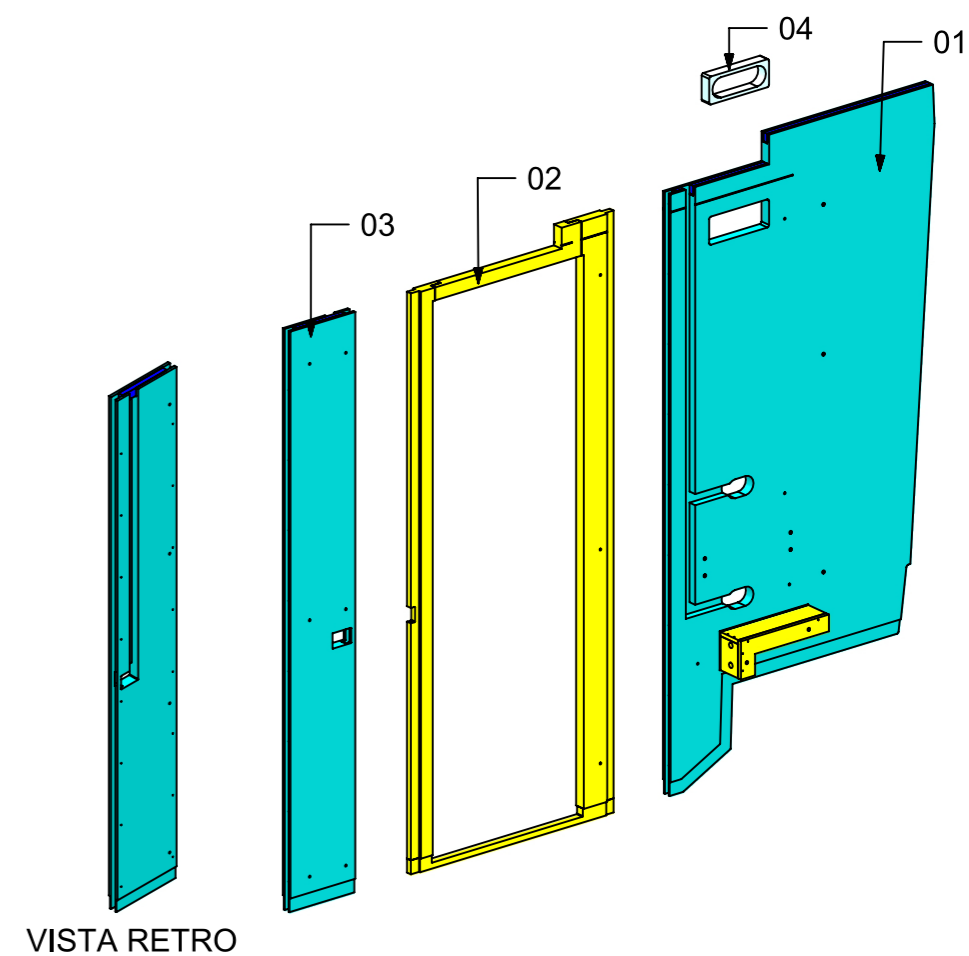

VISTA RETRO

| FERRAMENTA | QTY |
|------------------------------|-----|
| BUSSOLA 6MA X 10 FORO DIAM.8 | 13 |

| LOCALE | CODICE | DESCRIZIONE COMPONENTE | FINITURA | GR. |
|------------|------------|---|-------------------------|-----|
| PARATIE LD | MD320_PR35 | PARATIA PORTA BAGNO OSPITI SX_LOBBY LUNGONAVE | LARICROSS/OKUME' GREZZO | PTP |

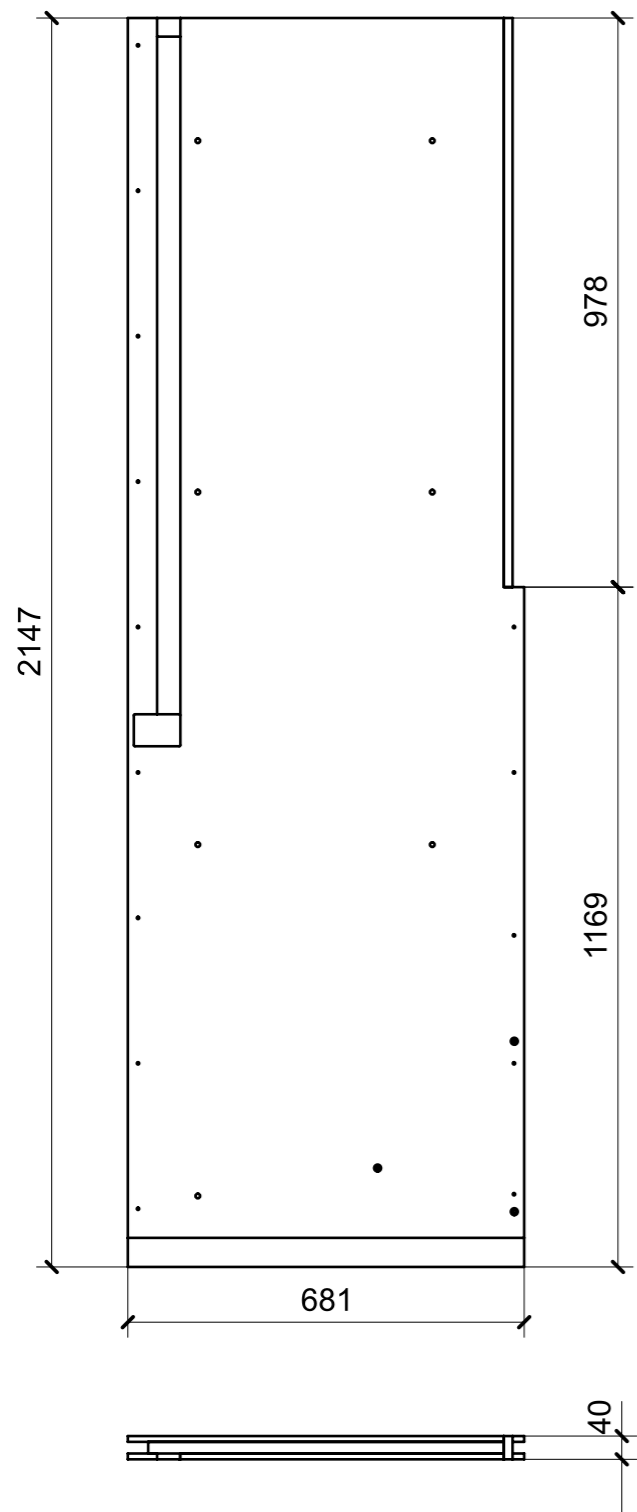

01

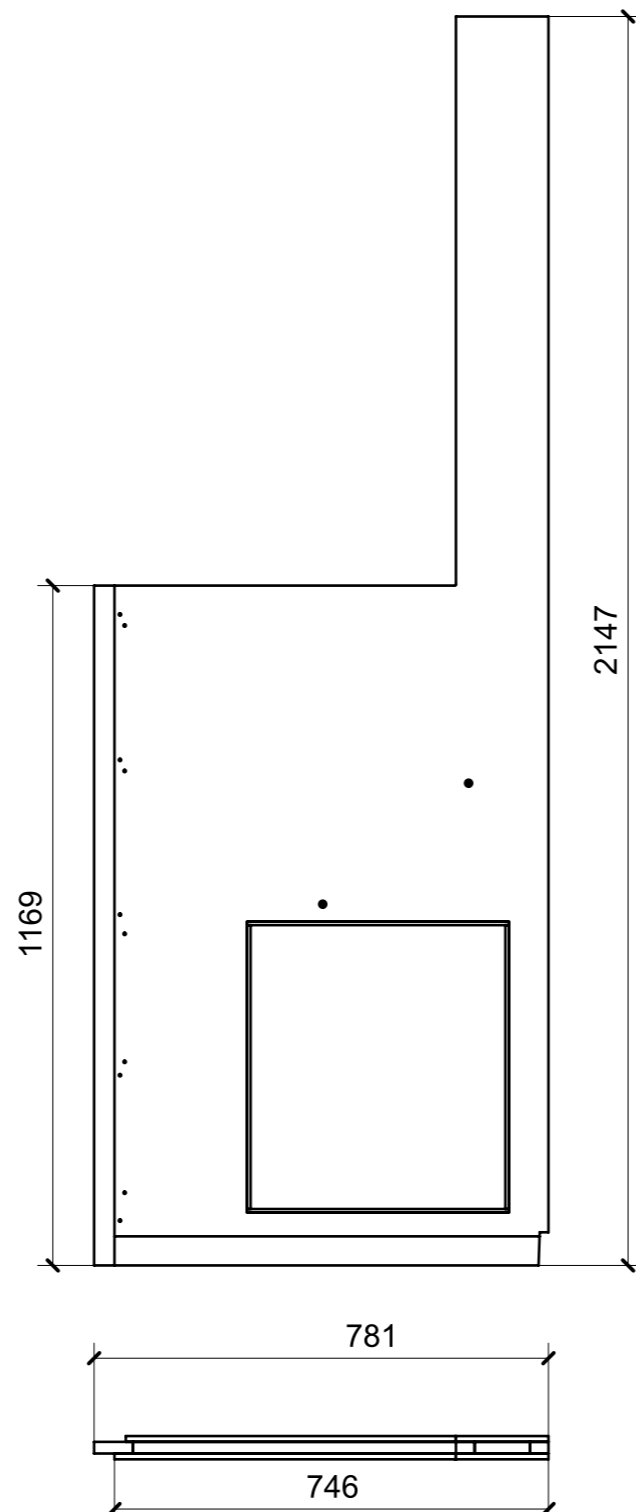

02

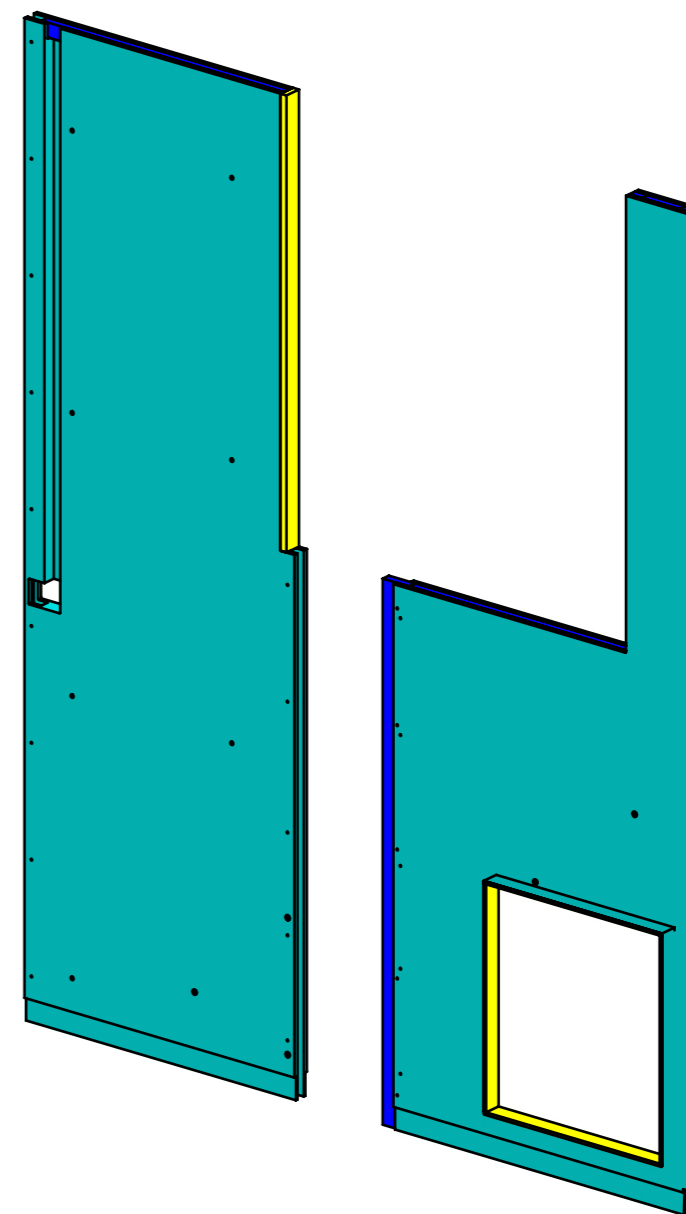

| FERRAMENTA | QTY |
|------------------------------|-----|
| BUSSOLA 6MA X 10 FORO DIAM.8 | 5 |

| LOCALE | CODICE | DESCRIZIONE COMPONENTE | FINITURA | GR. |
|------------|------------|---|---------------|-----|
| PARATIE LD | MD320_PR36 | PARATIA PORTA DOCCIA BAGNO OSPITI SX MURATA | OKUME' GREZZO | PTP |

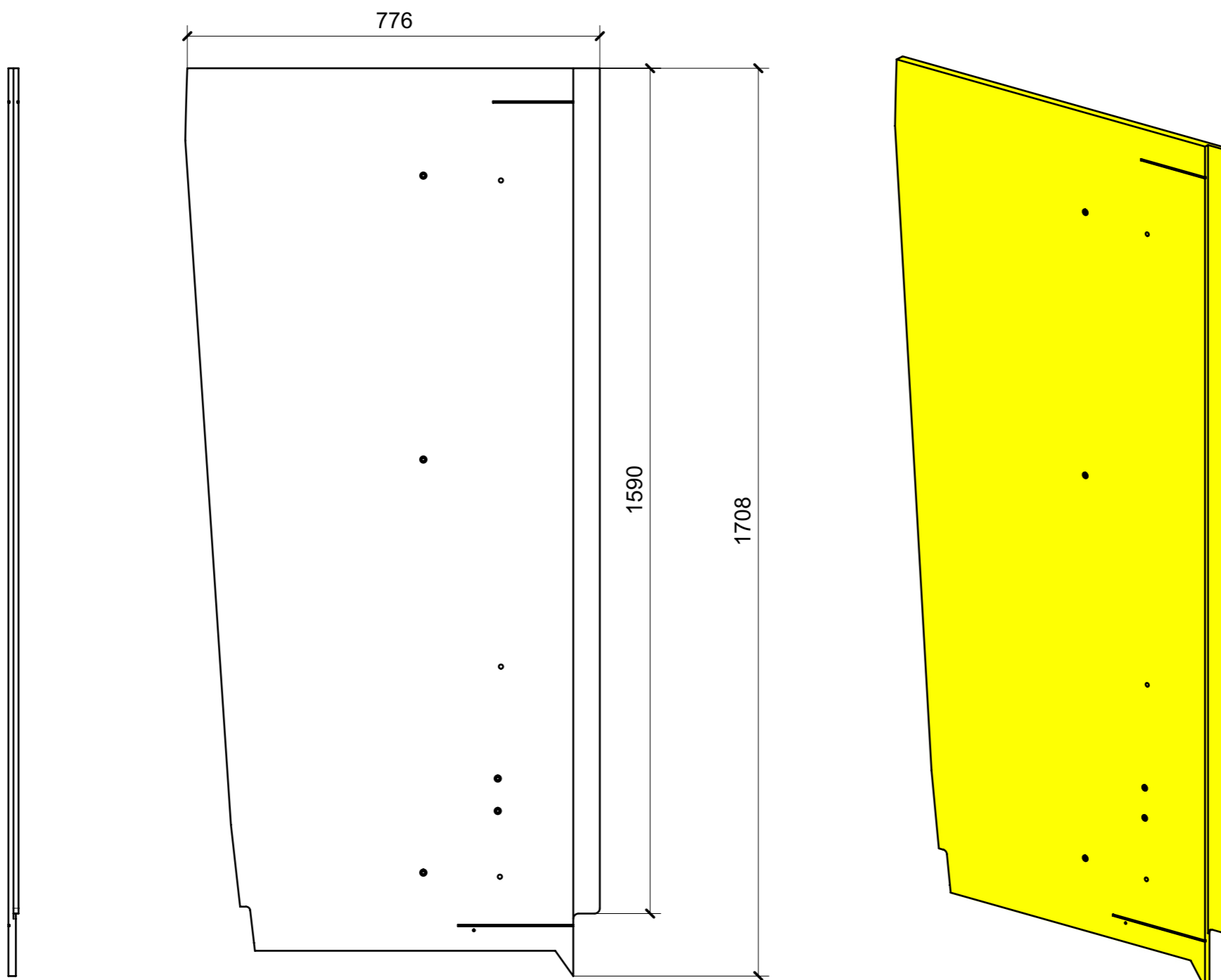

| FERRAMENTA | QTY |
|------------------------------|-----|
| BUSSOLA 6MA X 10 FORO DIAM.8 | 5 |

01

| LOCALE | CODICE | DESCRIZIONE COMPONENTE | FINITURA | GR. |
|------------|------------|--------------------------------------|---------------|-----|
| PARATIE LD | MD320_PR37 | PARATIA PORTA DOCCIA BAGNO OSPITI SX | OKUME' GREZZO | PTP |

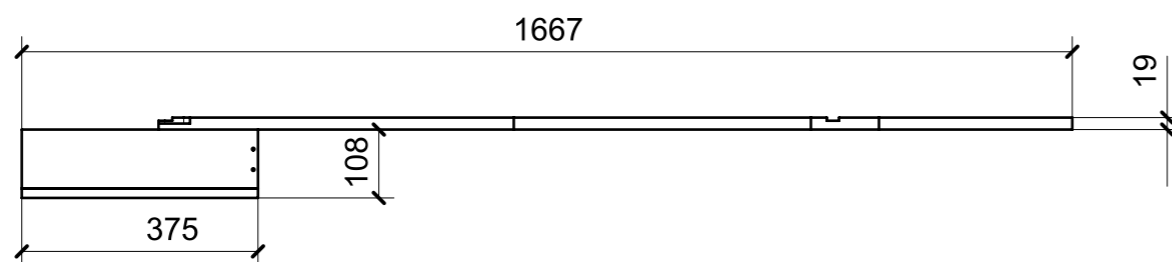
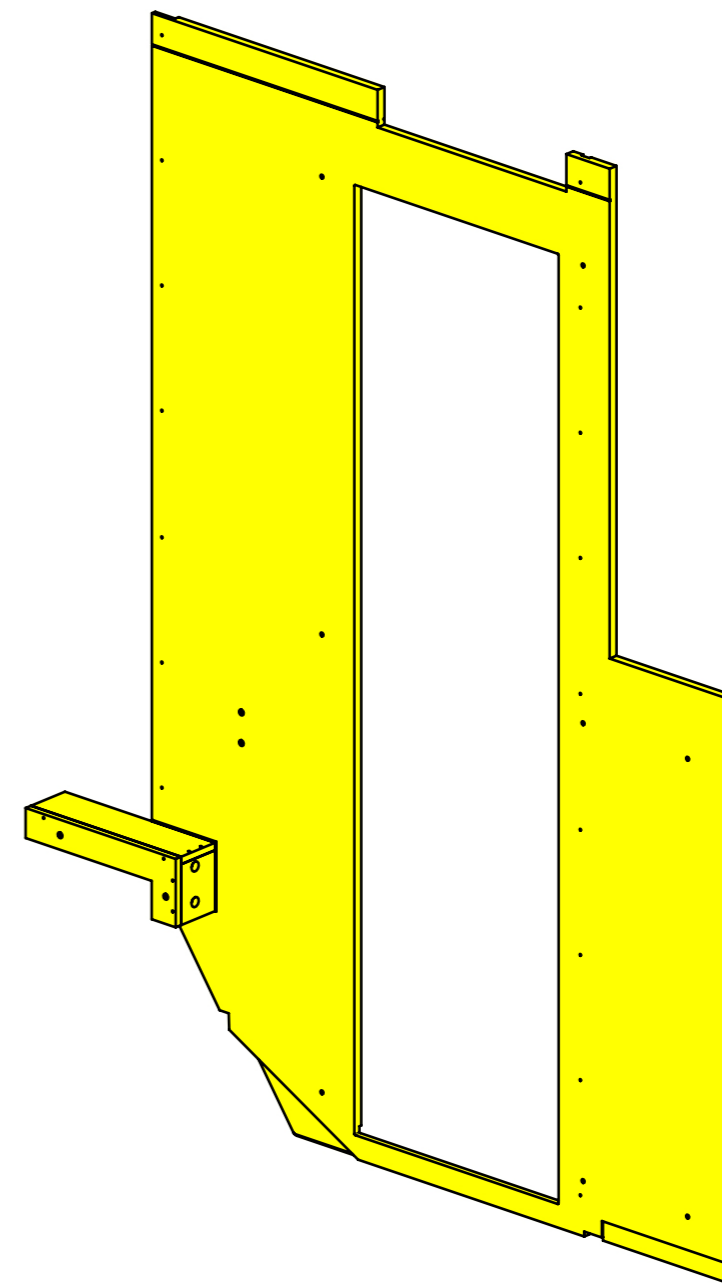
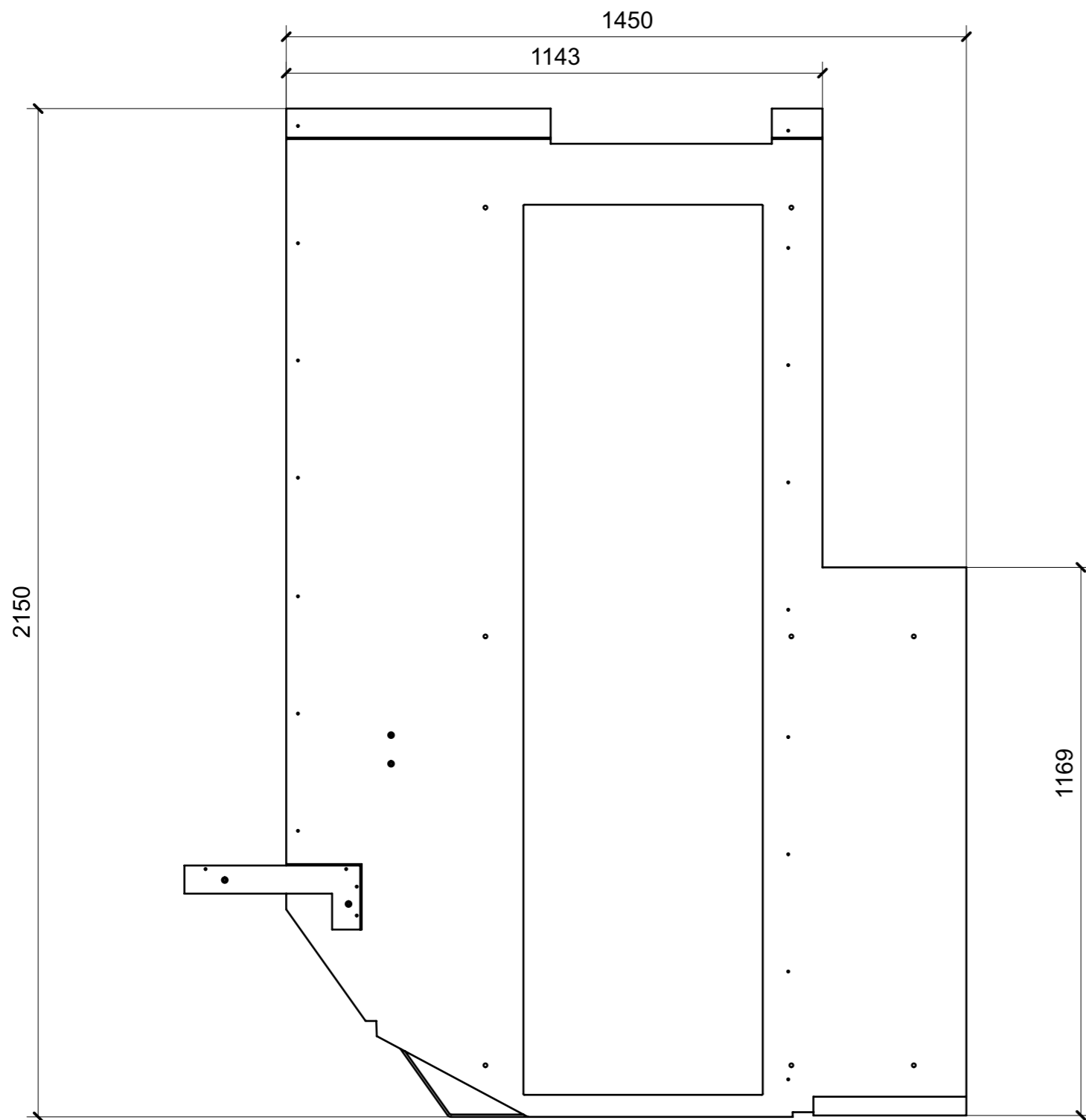

01

| FERRAMENTA | QTY |
|------------------------------|-----|
| BUSSOLA 6MA X 10 FORO DIAM.8 | 4 |

| LOCALE | CODICE | DESCRIZIONE COMPONENTE | FINITURA | GR. |
|------------|------------|--|---------------|-----|
| PARATIE LD | MD320_PR38 | PARATIA DOCCIA BAGNO OSPITI SX LUNGONAVE | OKUME' GREZZO | 2 |

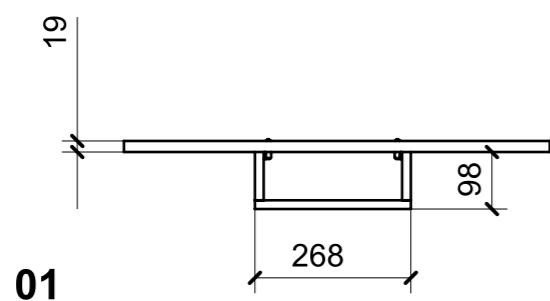
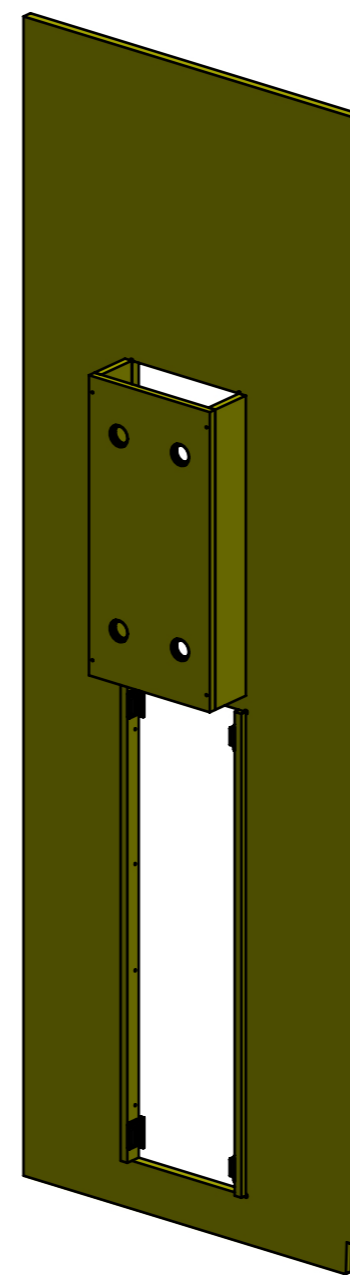
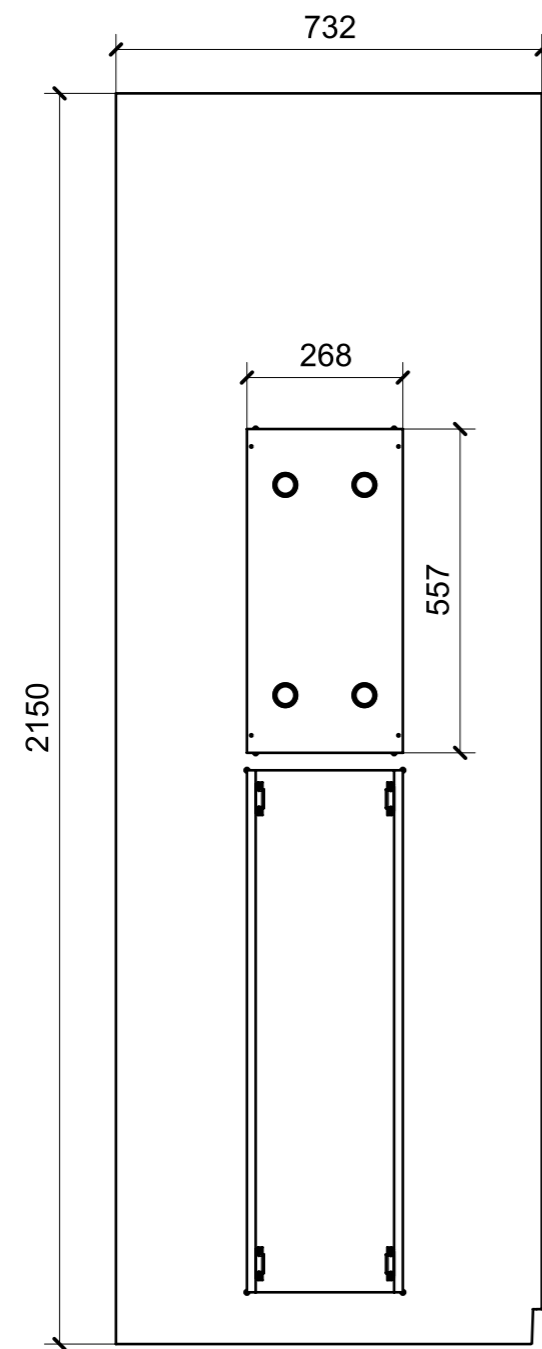

01

| FERRAMENTA | QTY |
|--|-----|
| FITLOCK F_MASCHERPA_6020101102 | 4 |
| CHIUSURA A SPINTA_TECHNOPARTNER_SOU C3-203 | 4 |

| LOCALE | CODICE | DESCRIZIONE COMPONENTE | FINITURA | GR. |
|------------|------------|--------------------------------------|------------------|-----|
| PARATIE LD | MD320_PR39 | PARATIA PORTA BAGNO OSPITI DX MURATA | LARICROSS/OKUME' | PTP |

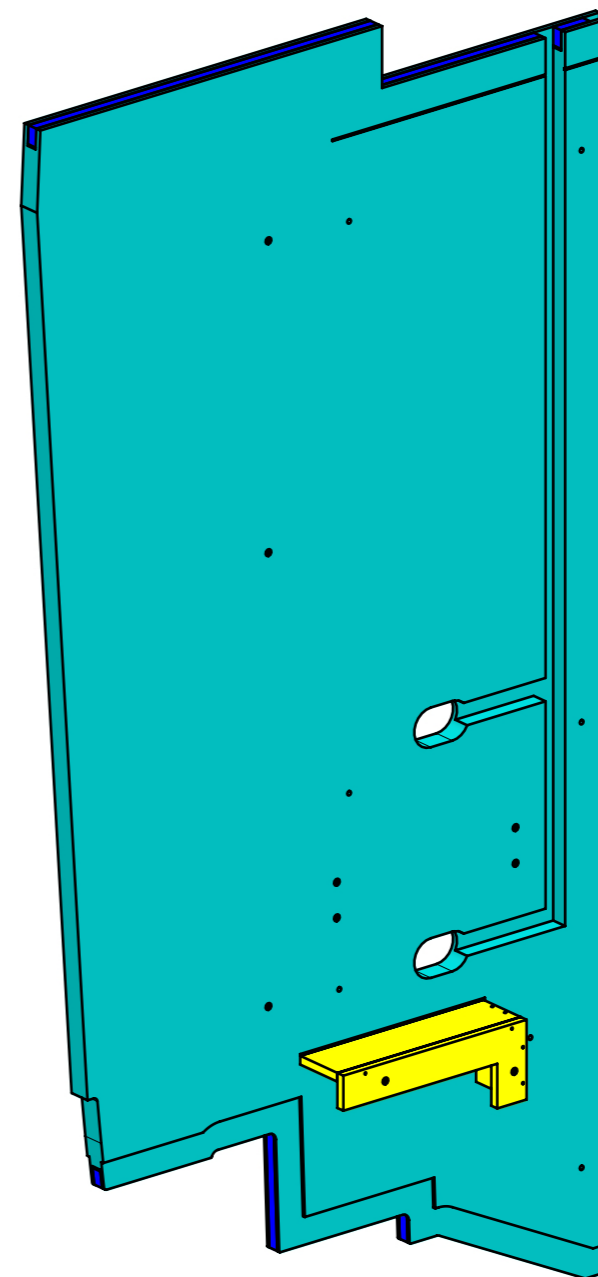
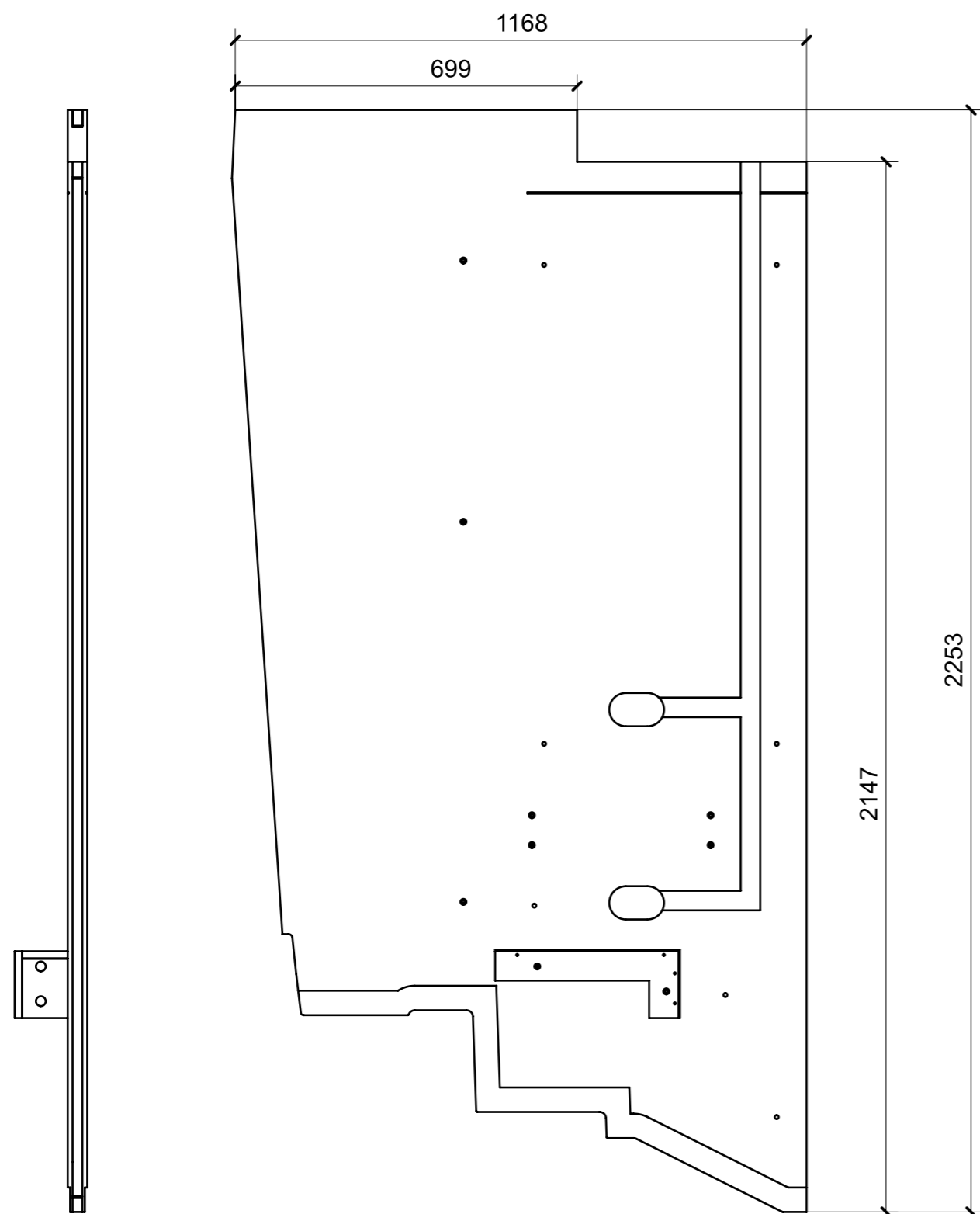

01

| FERRAMENTA | QTY |
|------------------------------|-----|
| BUSSOLA 6MA X 10 FORO DIAM.8 | 12 |

| LOCALE | CODICE | DESCRIZIONE COMPONENTE | FINITURA | GR. |
|------------|------------|-------------------------------|-------------------------|-----|
| PARATIE LD | MD320_PR40 | PARATIA PORTA BAGNO OSPITI DX | LARICROSS/OKUME' GREZZO | 2 |

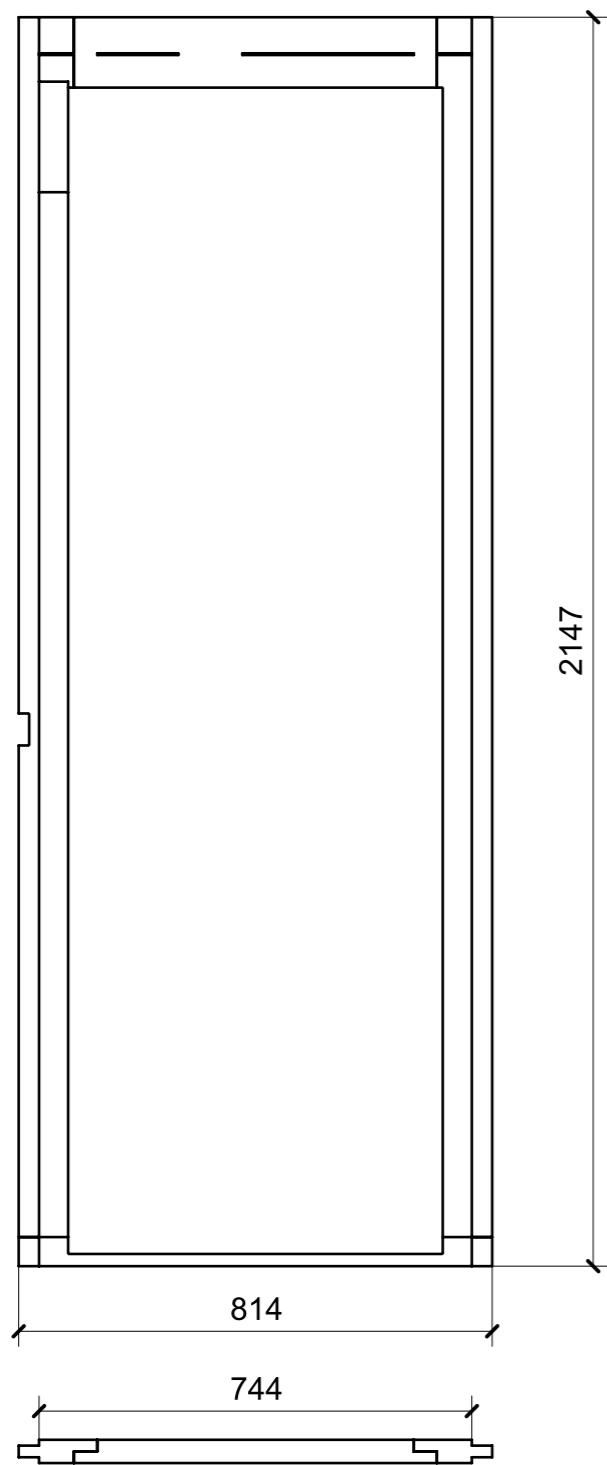

01
OKUME' GREZZO

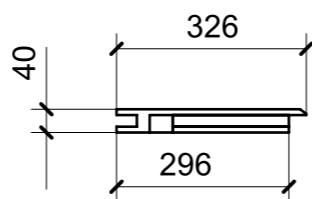
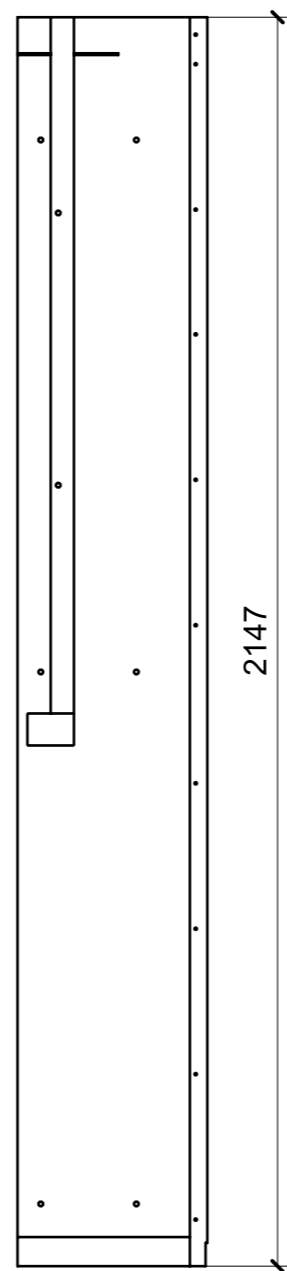

02
LARICROSS

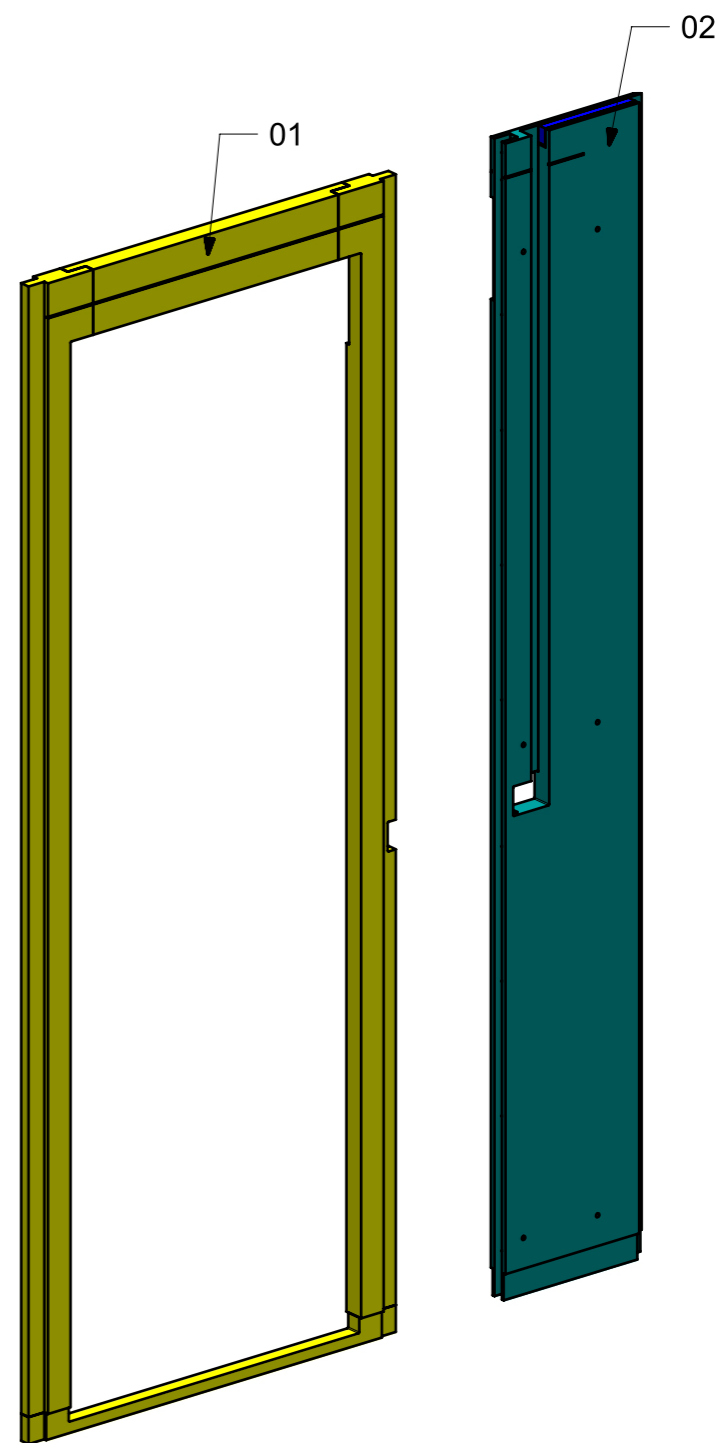

| LOCALE | CODICE | DESCRIZIONE COMPONENTE | FINITURA | GR. |
|------------|------------|-----------------------------------|----------------------------------|-----|
| PARATIE LD | MD320_PR41 | PARATIA PORTA BAGNO OSPITI DX A.C | LARICROSS/ GREZZO SPRUZZATO NERO | 2 |

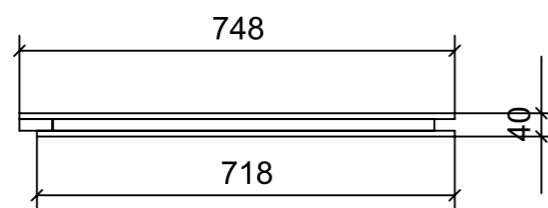
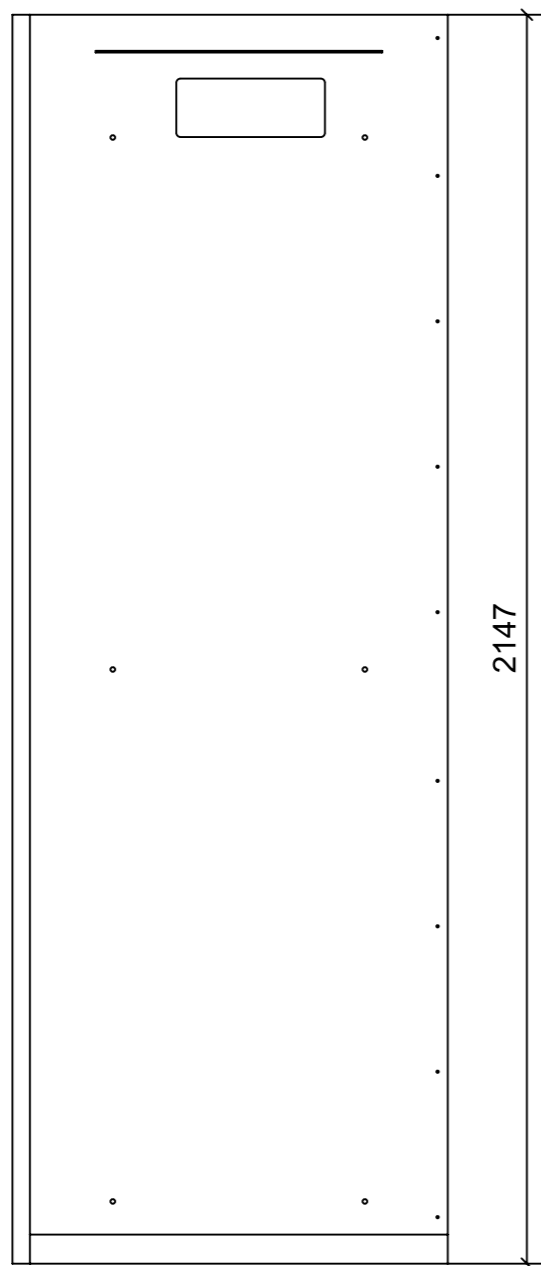

01
LARICROSS

GREZZO
ANTI ROMBO

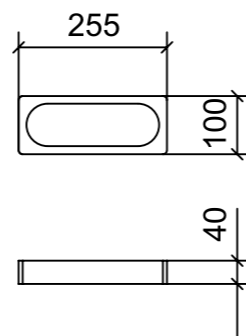

02

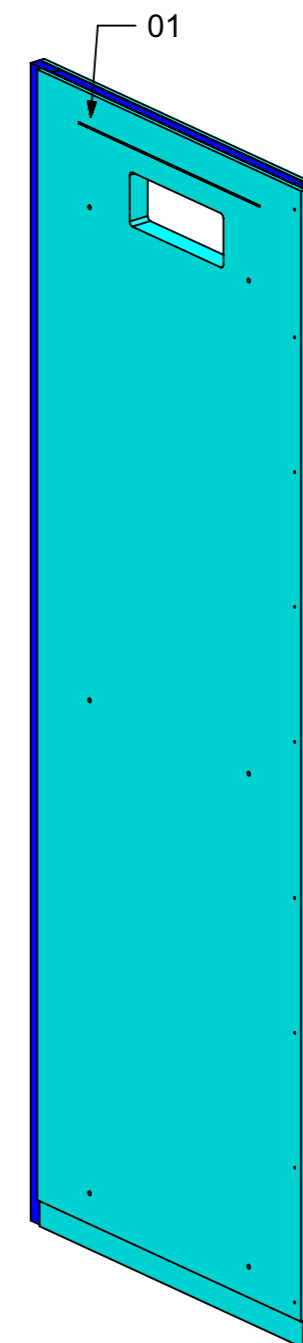
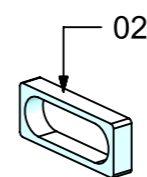

| LOCALE | CODICE | DESCRIZIONE COMPONENTE | FINITURA | GR. |
|------------|------------|--|-----------|-----|
| PARATIE LD | MD320_PR42 | PARATIA CABINA OSPITI DX_LOBBY DX PRUA | LARICROSS | PTP |

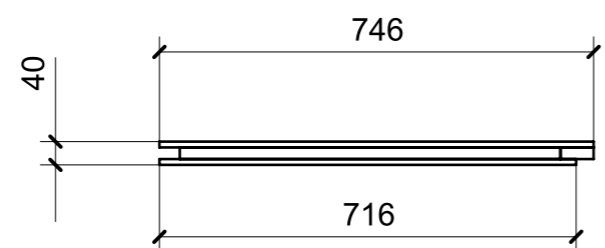
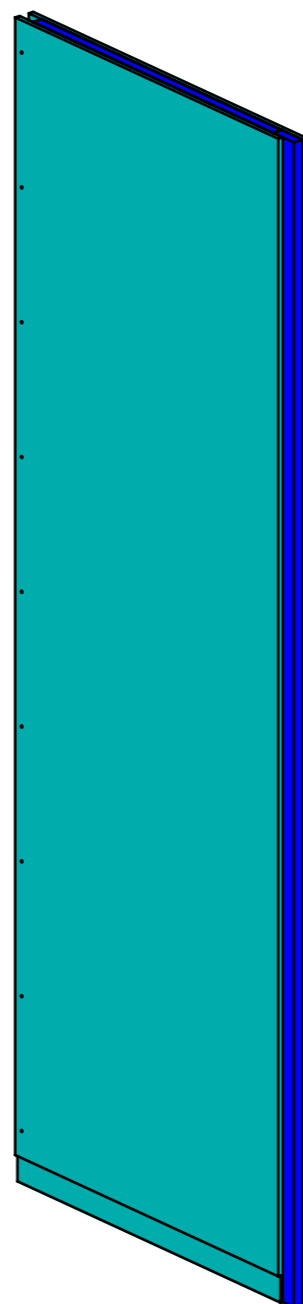
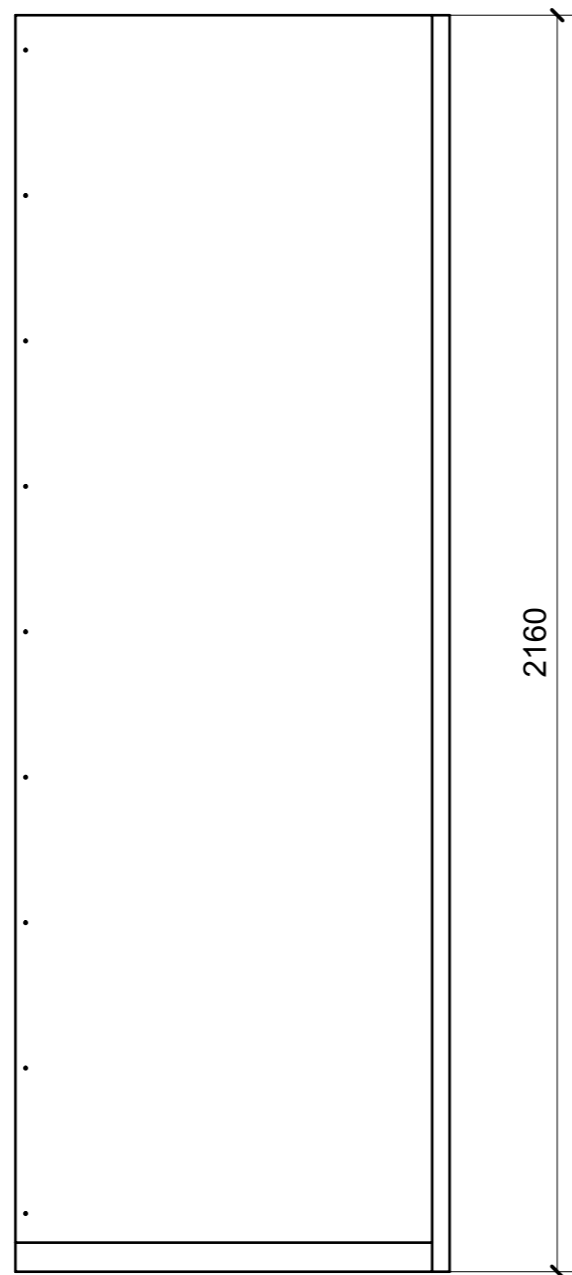

01

| FERRAMENTA | QTY |
|------------------------------|-----|
| BUSSOLA 6MA X 10 FORO DIAM.8 | 3 |

| LOCALE | CODICE | DESCRIZIONE COMPONENTE | FINITURA | GR. |
|------------|------------|-------------------------------|--------------------|-----|
| PARATIE LD | MD320_PR43 | PARATIA CABINA OSPITI DX PRUA | LARICROSS / OKUME' | PTP |

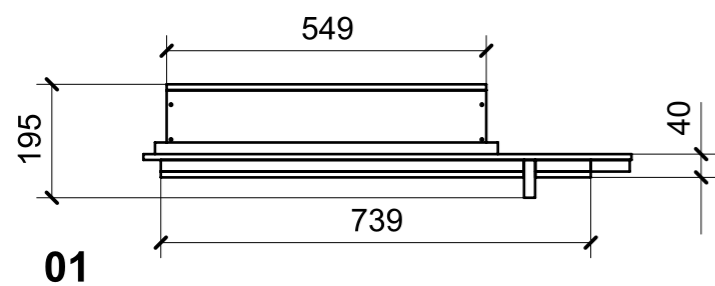
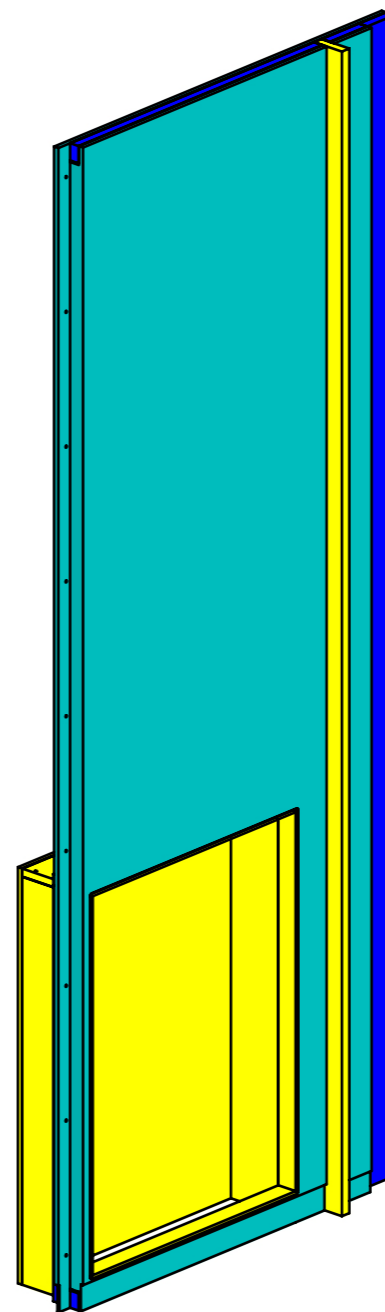
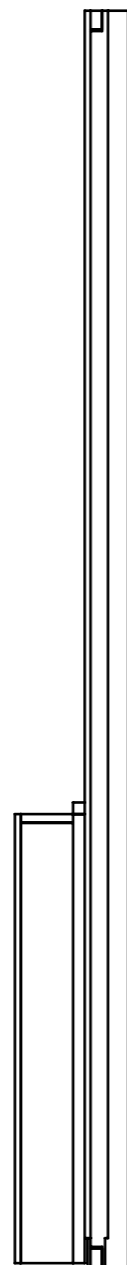
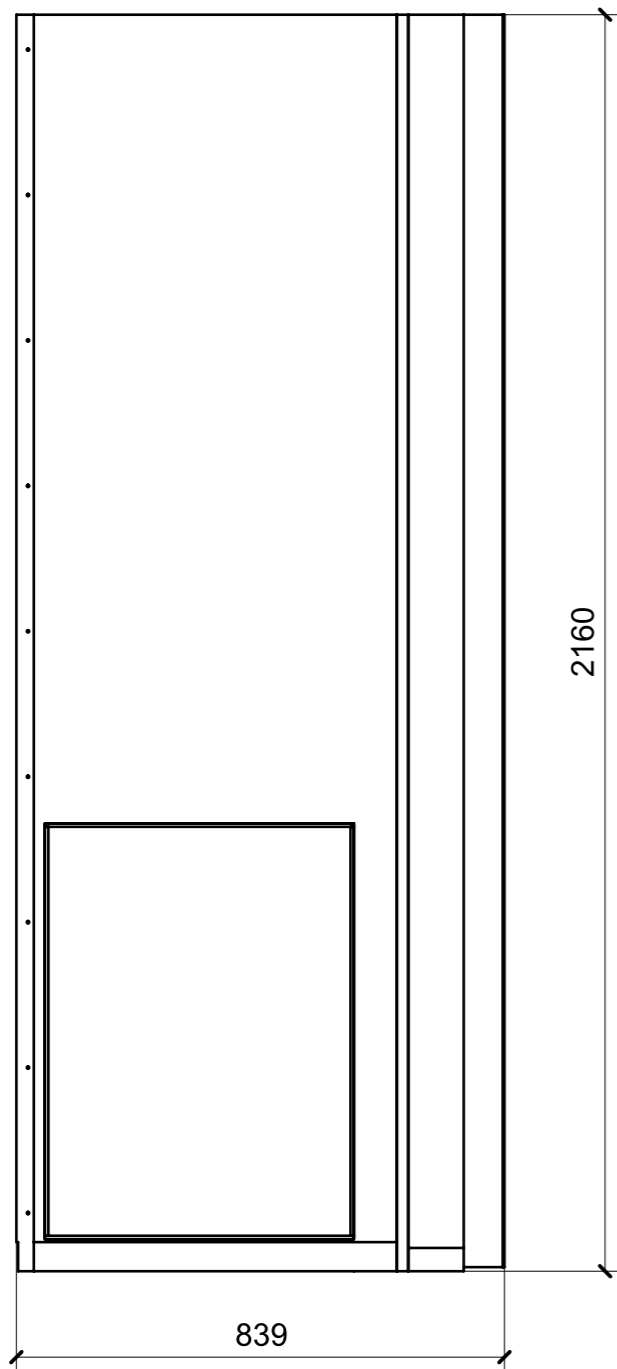

01

| FERRAMENTA | QTY |
|------------------------------|-----|
| BUSSOLA 6MA X 10 FORO DIAM.8 | 3 |

| LOCALE | CODICE | DESCRIZIONE COMPONENTE | FINITURA | GR. |
|------------|-------------|--------------------------------------|---------------|-----|
| PARATIE LD | MD320__PR44 | PARATIA PORTA DOCCIA BAGNO OSPITI DX | OKUME' GREZZO | PTP |

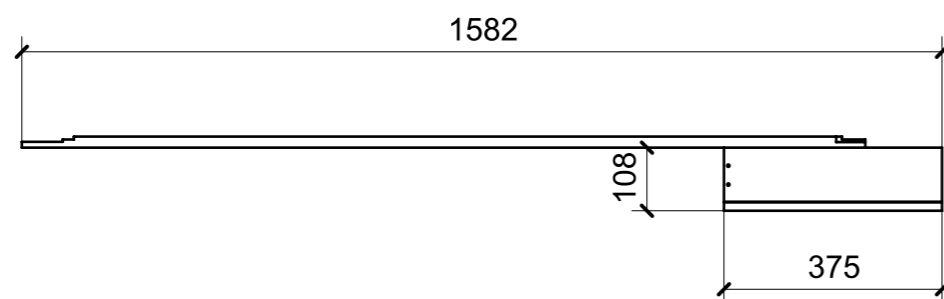
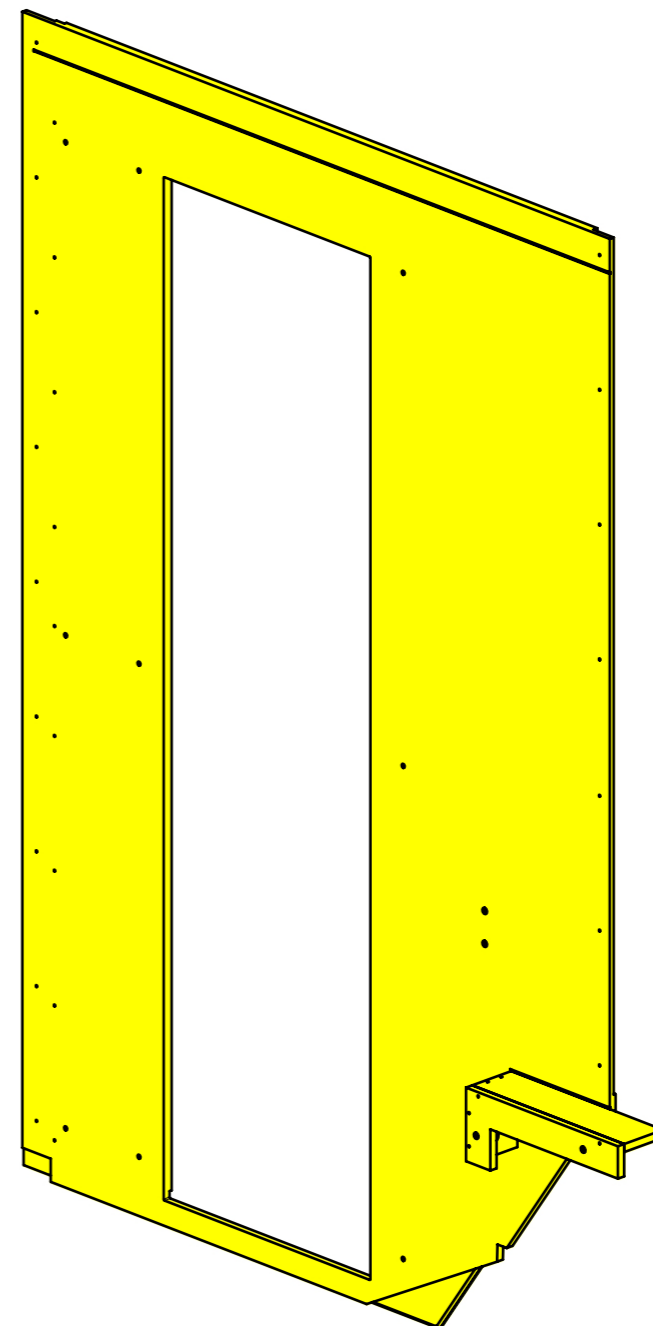
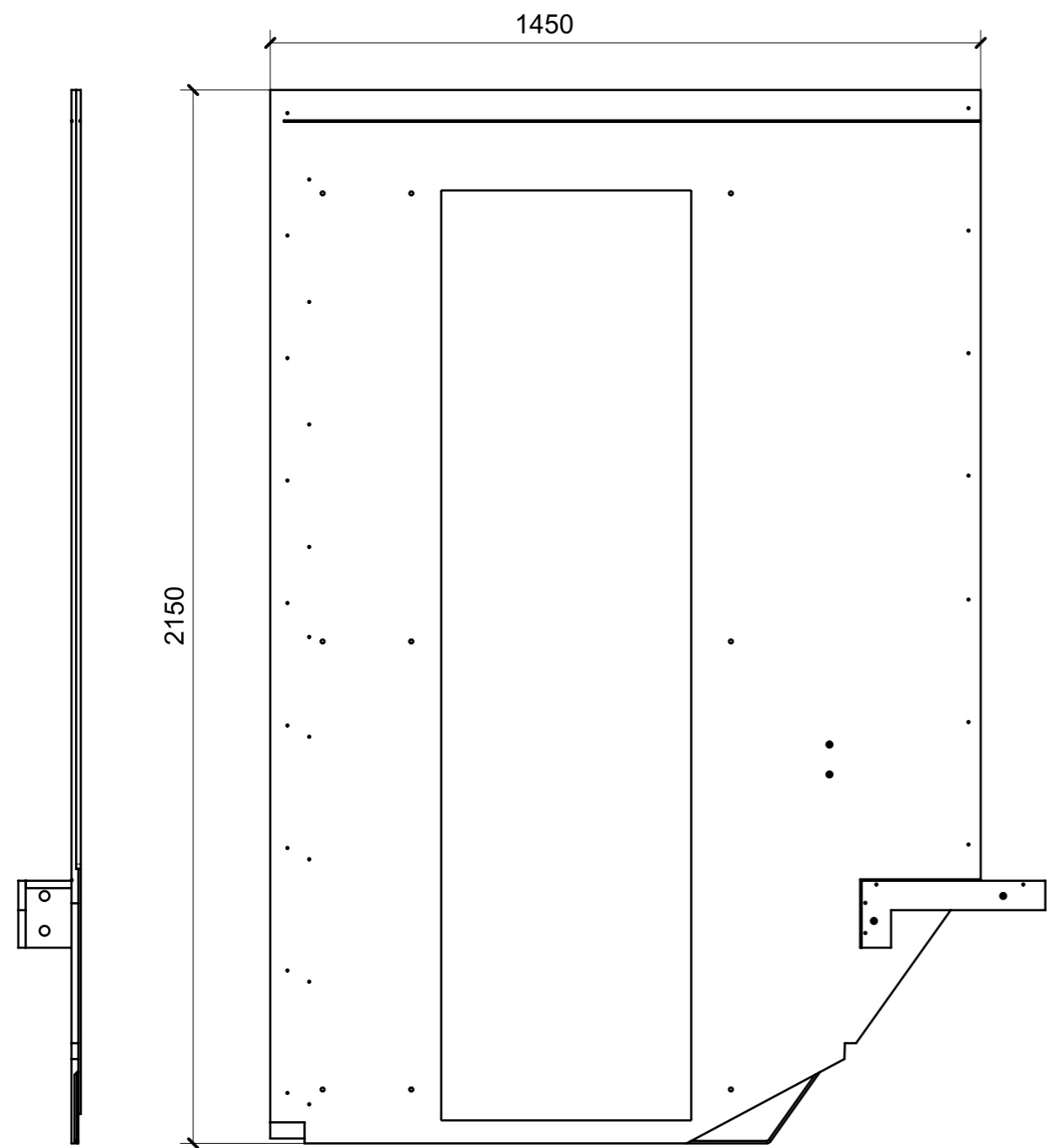

01

| FERRAMENTA | QTY |
|------------------------------|-----|
| BUSSOLA 6MA X 10 FORO DIAM.8 | 4 |

| LOCALE | CODICE | DESCRIZIONE COMPONENTE | FINITURA | GR. |
|------------|------------|-------------------------------------|---------------|-----|
| PARATIE LD | MD320_PR45 | PARATIA BAGNO OSPITI DX CENTRO NAVE | OKUME' GREZZO | 2 |

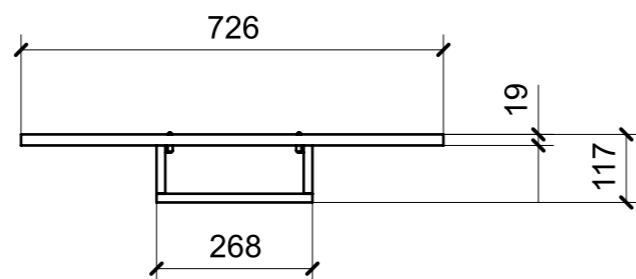
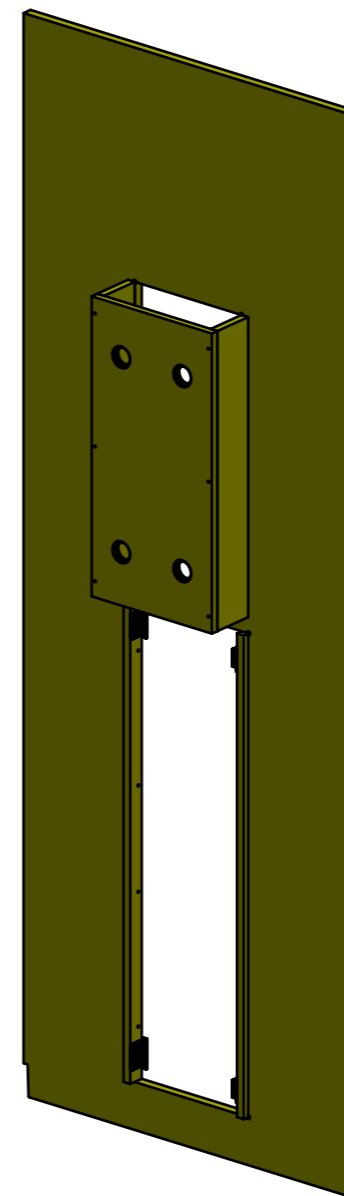
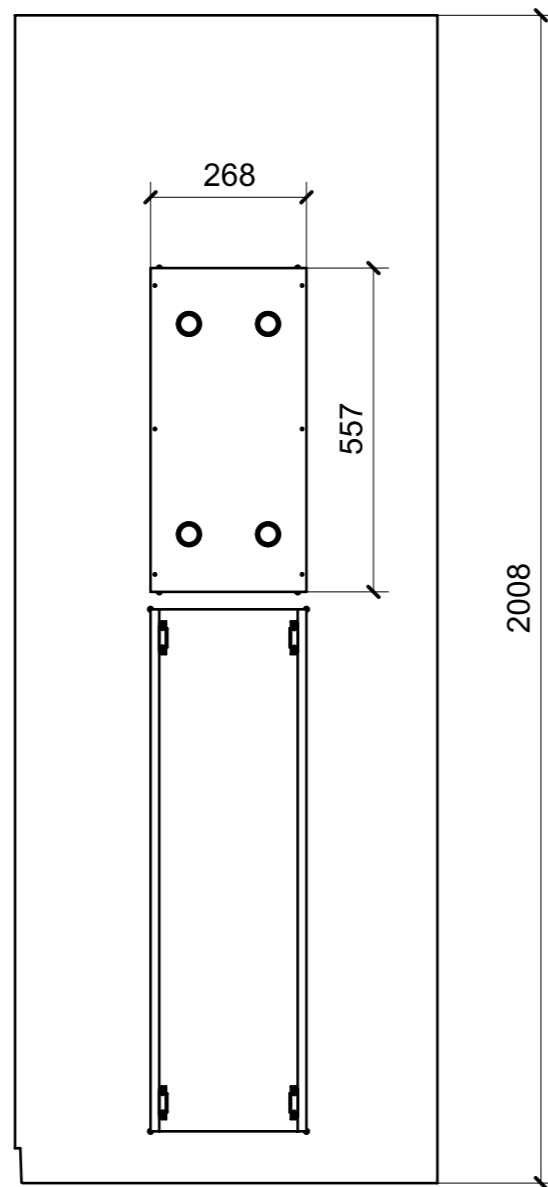

01

| FERRAMENTA | QTY |
|--|-----|
| CHIUSURA A SPINTA_TECHNOPARTNER_SOU C3-203 | 4 |
| FITLOCK F_MASCHERPA_6020101102 | 4 |

| LOCALE | CODICE | DESCRIZIONE COMPONENTE | FINITURA | GR. |
|------------|------------|--------------------------------------|---------------|-----|
| PARATIE LD | MD320_PR46 | PARATIA PORTA DOCCIA BAGNO OSPITI DX | OKUME' GREZZO | PTP |

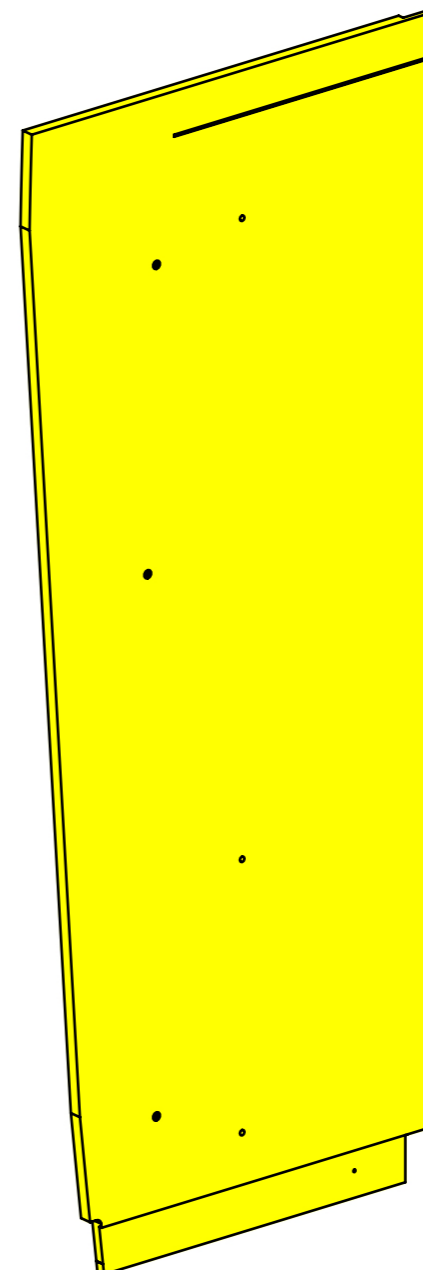
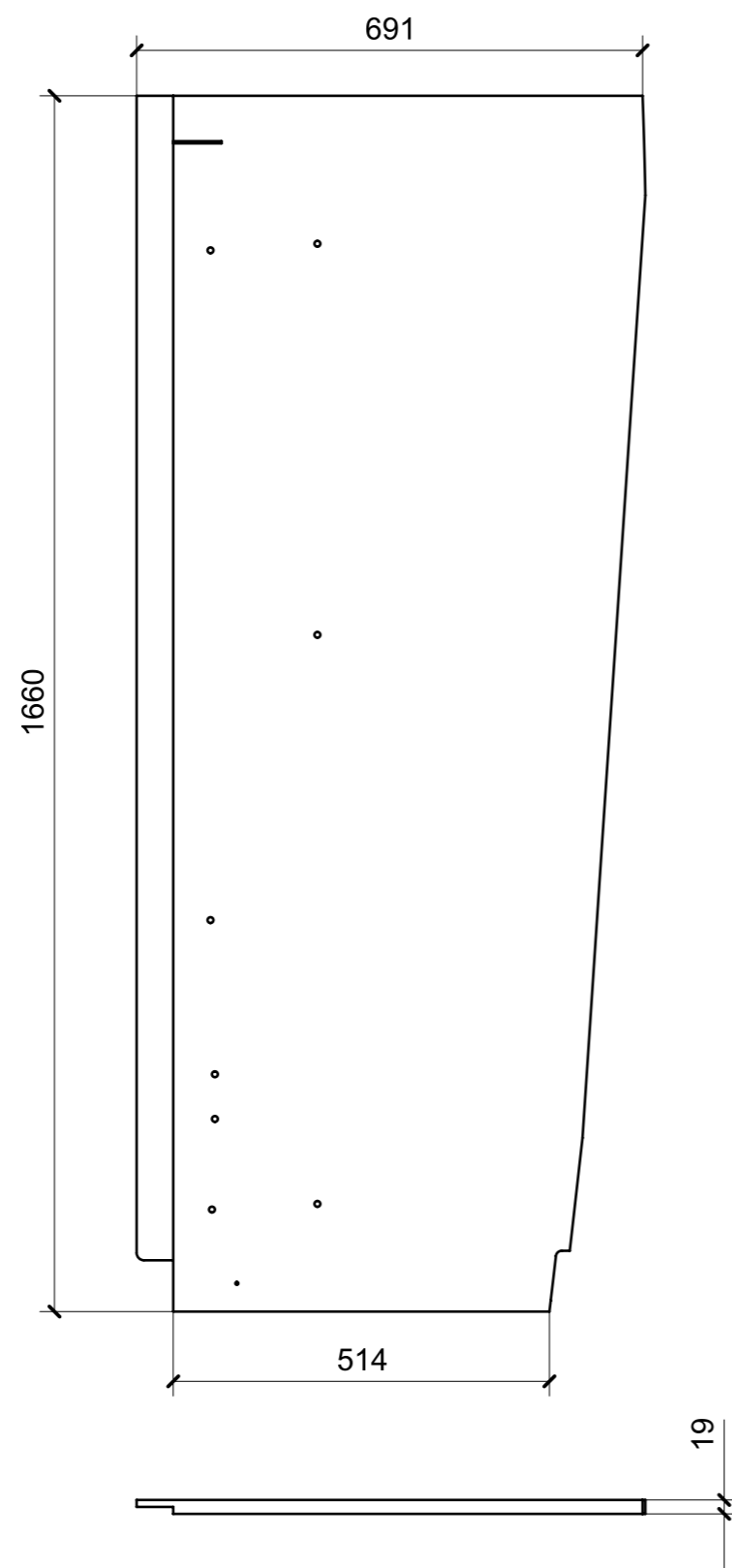

01

| FERRAMENTA | QTY |
|------------------------------|-----|
| BUSSOLA 6MA X 10 FORO DIAM.8 | 3 |