

LOCALE	CODICE	DESCRIZIONE COMPONENTE	FINITURA	GR.
BAGNO ARMATORE	MD320_R01_WA01	PARETE MOBILE BAGNO	LAISTRA SCURA	4

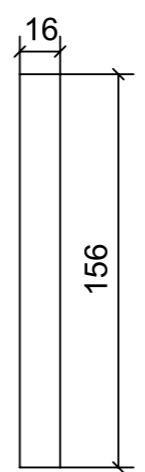

01

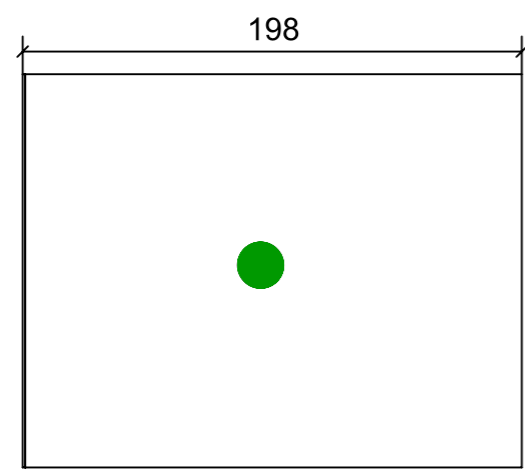
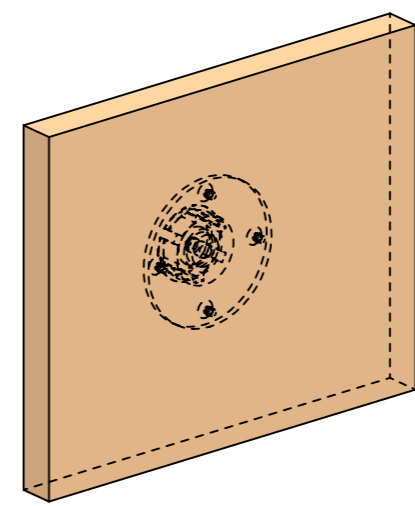
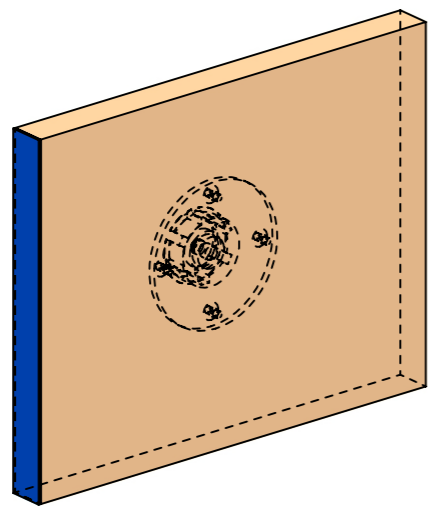
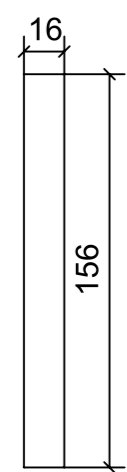
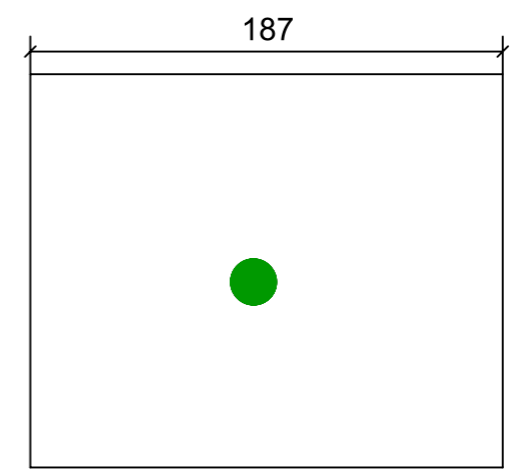

02

FERRAMENTA	QTY
FITLOCK M_MASCHERPA_3MM_6020202101	2

VERNICIATURA LASTRA/LACCATI:
 ● = VERNICIARE 1 LATO + FILI RASATI O BORDATI NESSUN SIMBOLO = VERNICIARE 2 LATI + FILI RASATI O BORDATI

LOCALE	CODICE	DESCRIZIONE COMPONENTE	FINITURA	GR.
BAGNO ARMATORE	MD320_R01_WAA01	RIV.MOBILE BAGNO VAR.1-2	LASTRA SCURA	PTP

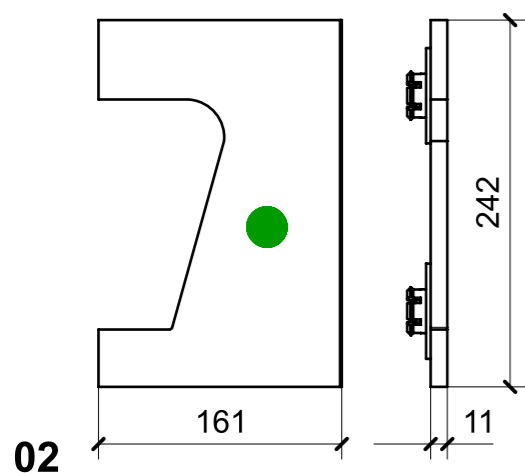
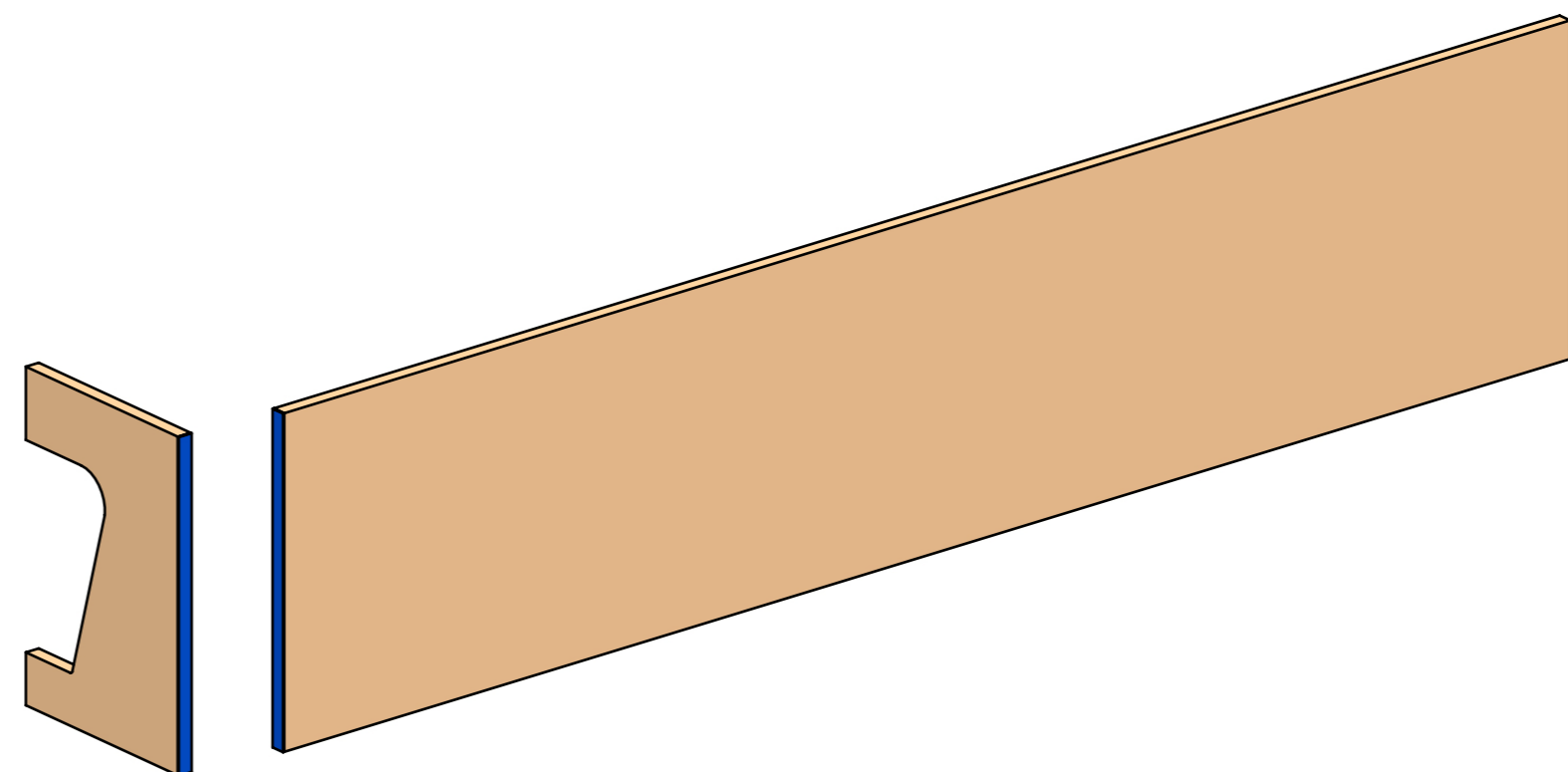

FERRAMENTA	QTY
FITLOCK M_MASCHERPA_3MM_6020202101	8

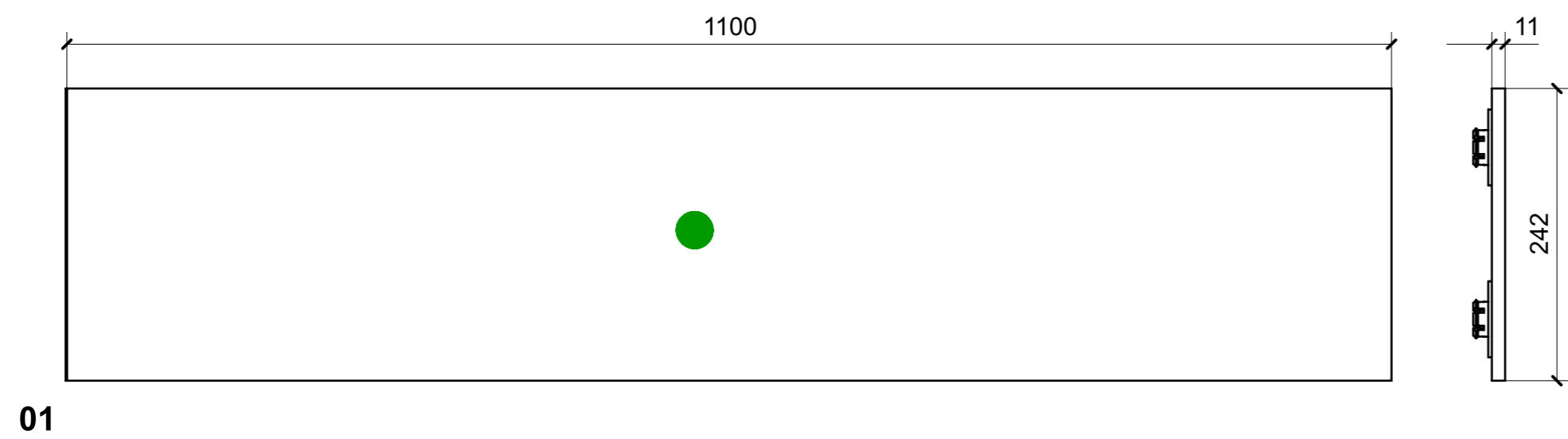

VERNICIATURA LASTRA/LACCATI:
 ● = FILI RASATI ● = VERNICIARE 1 LATO + FILI RASATI O BORDATI NESSUN SIMBOLO = VERNICIARE 2 LATI + FILI RASATI O BORDATI

LOCALE	CODICE	DESCRIZIONE COMPONENTE	FINITURA	GR.
BAGNO ARMATORE	MD320_R01_WWA01	RIV.MOBILE BAGNO VAR.3-4	LASTRA SCURA	PTP

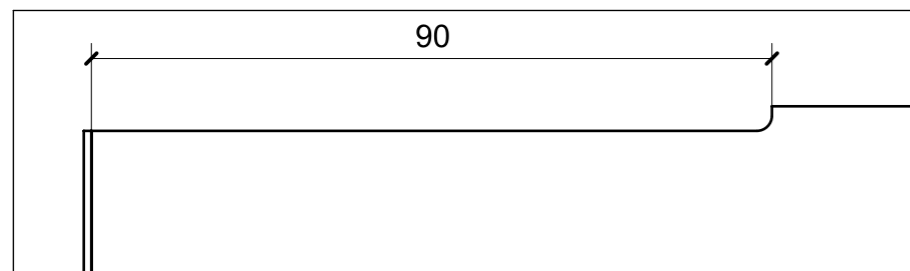

DETAIL B
SCALE 1:1

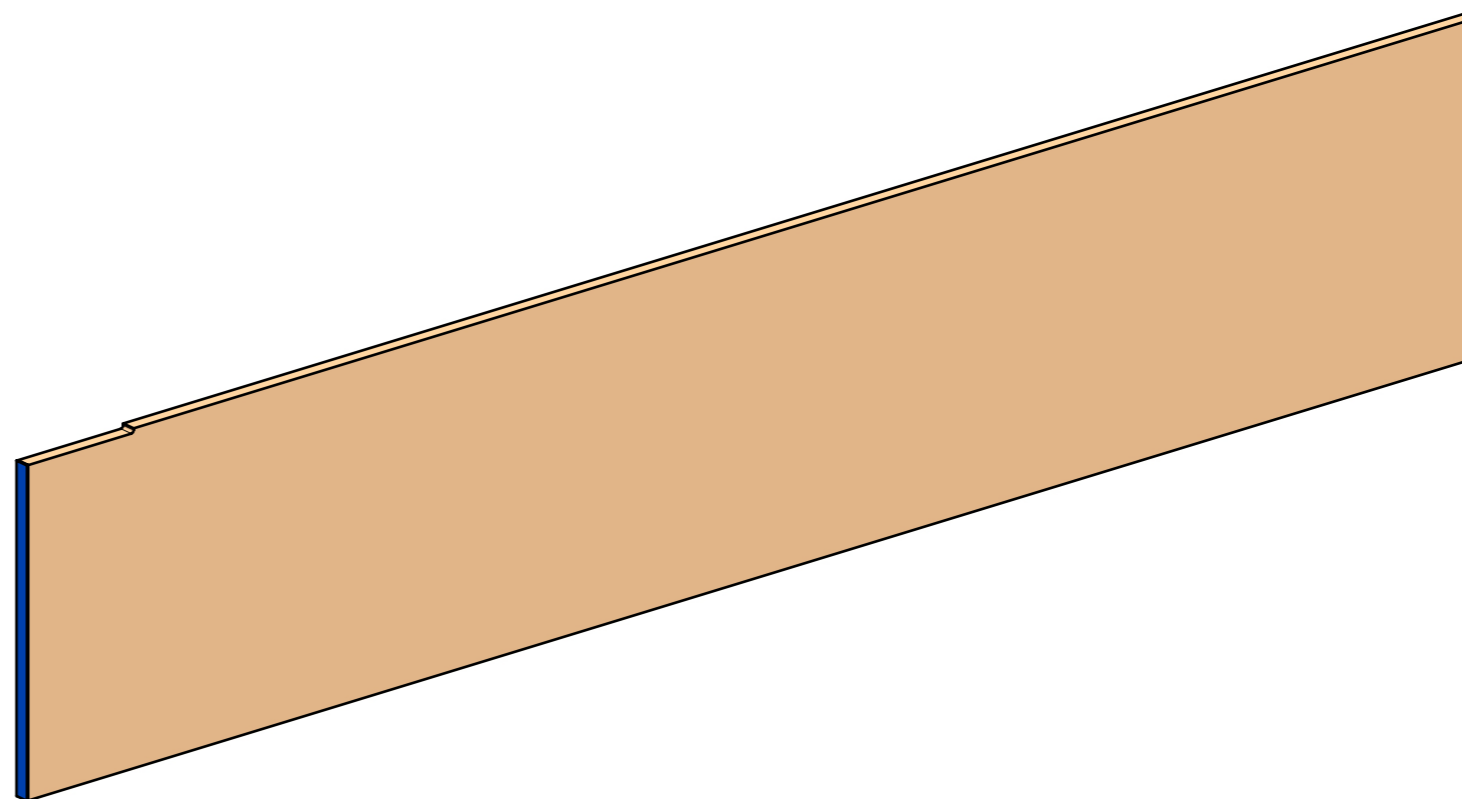

FERRAMENTA	QTY
FITLOCK M_MASCHERPA_3MM_6020202101	6

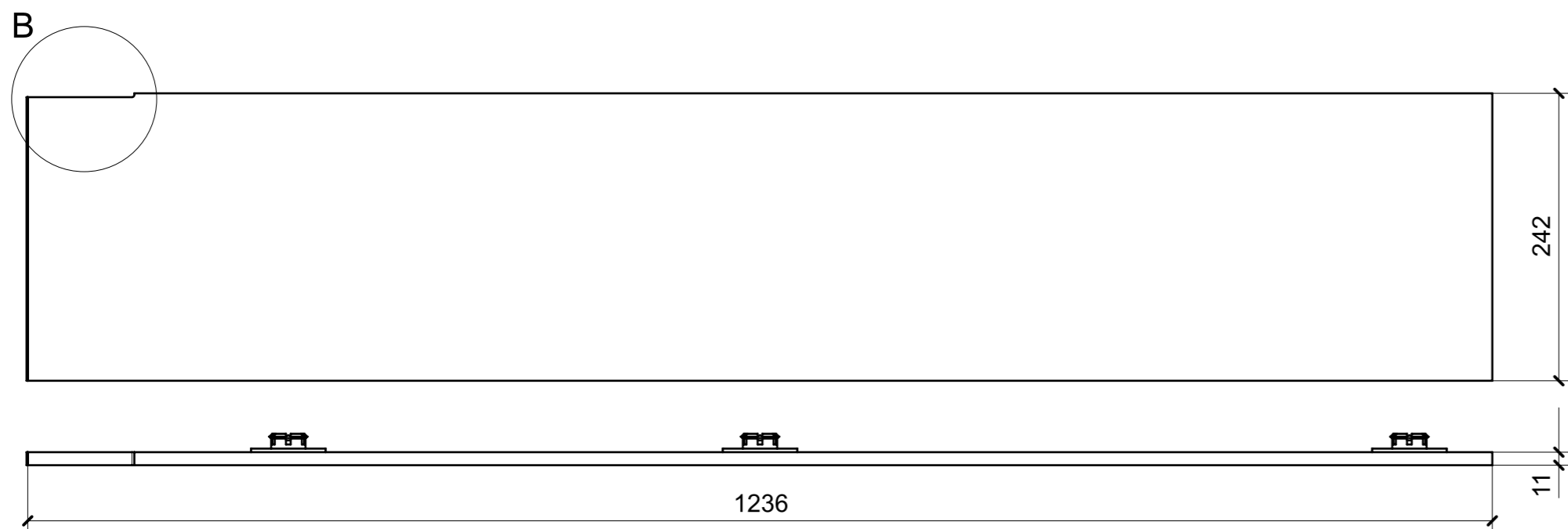

VERNICIATURA LASTRA/LACCATI:

● = FILI RASATI

● = VERNICIARE 1 LATO + FILI RASATI O BORDATI

NESSUN SIMBOLO = VERNICIARE 2 LATI + FILI RASATI O BORDATI

LOCALE	CODICE	DESCRIZIONE COMPONENTE	FINITURA	GR.
BAGNO ARMATORE	MD320_R02_WB01	PARETE INGRESSO DOCCIA	LASTRA CHIARA	2

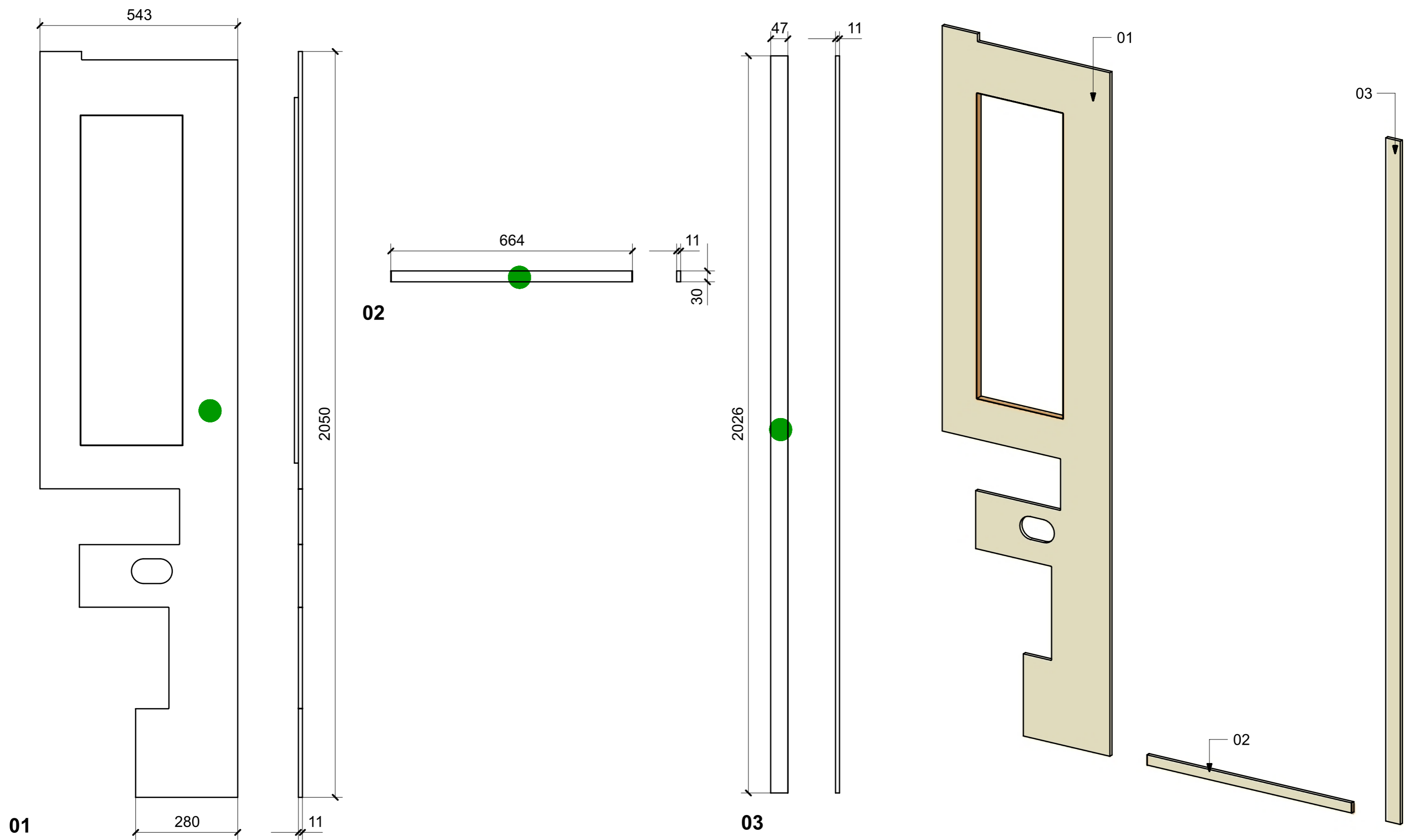

01

02

03

01

03

02

VERNICIATURA LASTRA/LACCATI:

● = FILI RASATI

● = VERNICIARE 1 LATO + FILI RASATI O BORDATI

NESSUN SIMBOLO = VERNICIARE 2 LATI + FILI RASATI O BORDATI

LOCALE	CODICE	DESCRIZIONE COMPONENTE	FINITURA	GR.
BAGNO ARMATORE	MD320_R03_WC01	MOBILE IN NICCHIA SOPRA LAVABO	IROKO	2

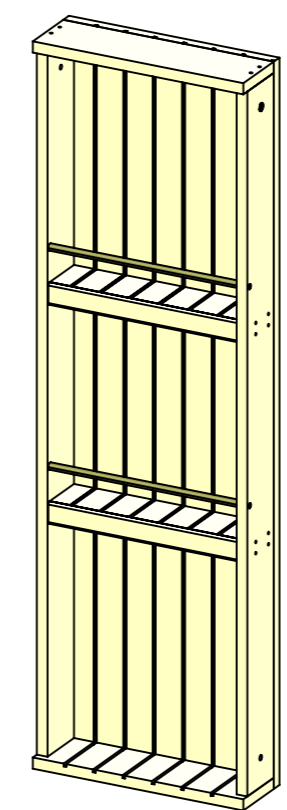
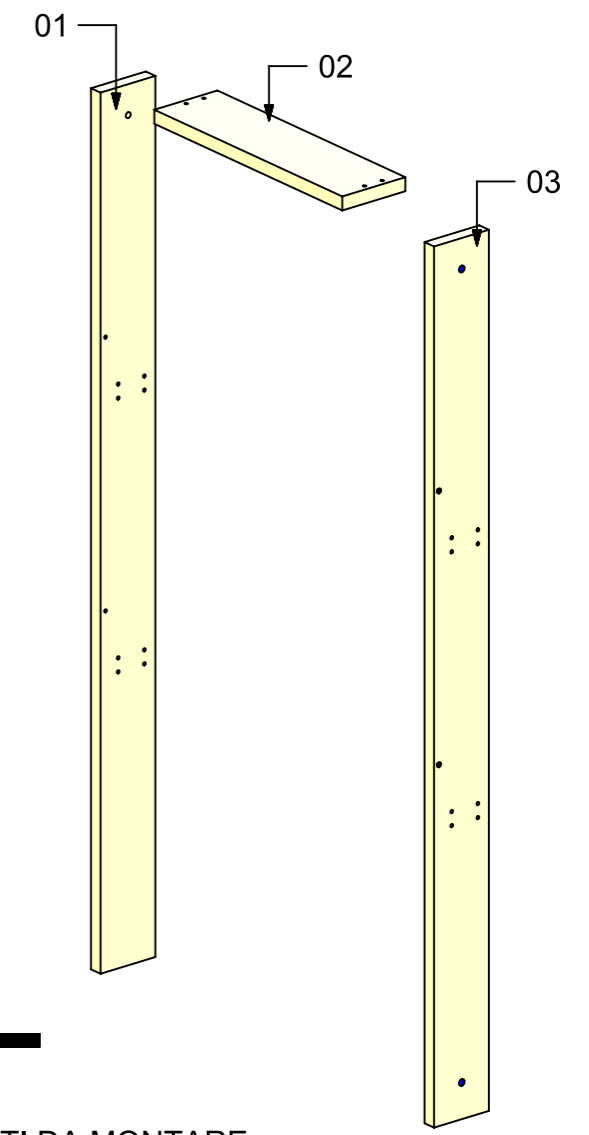
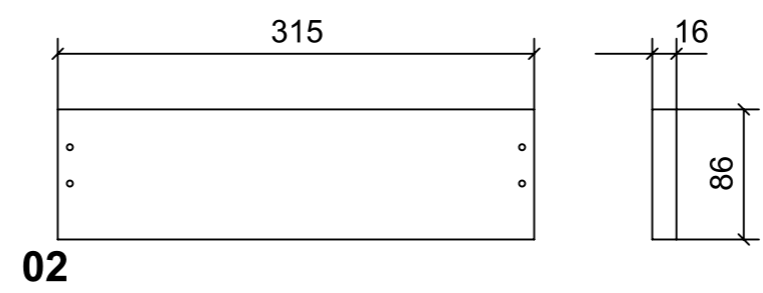
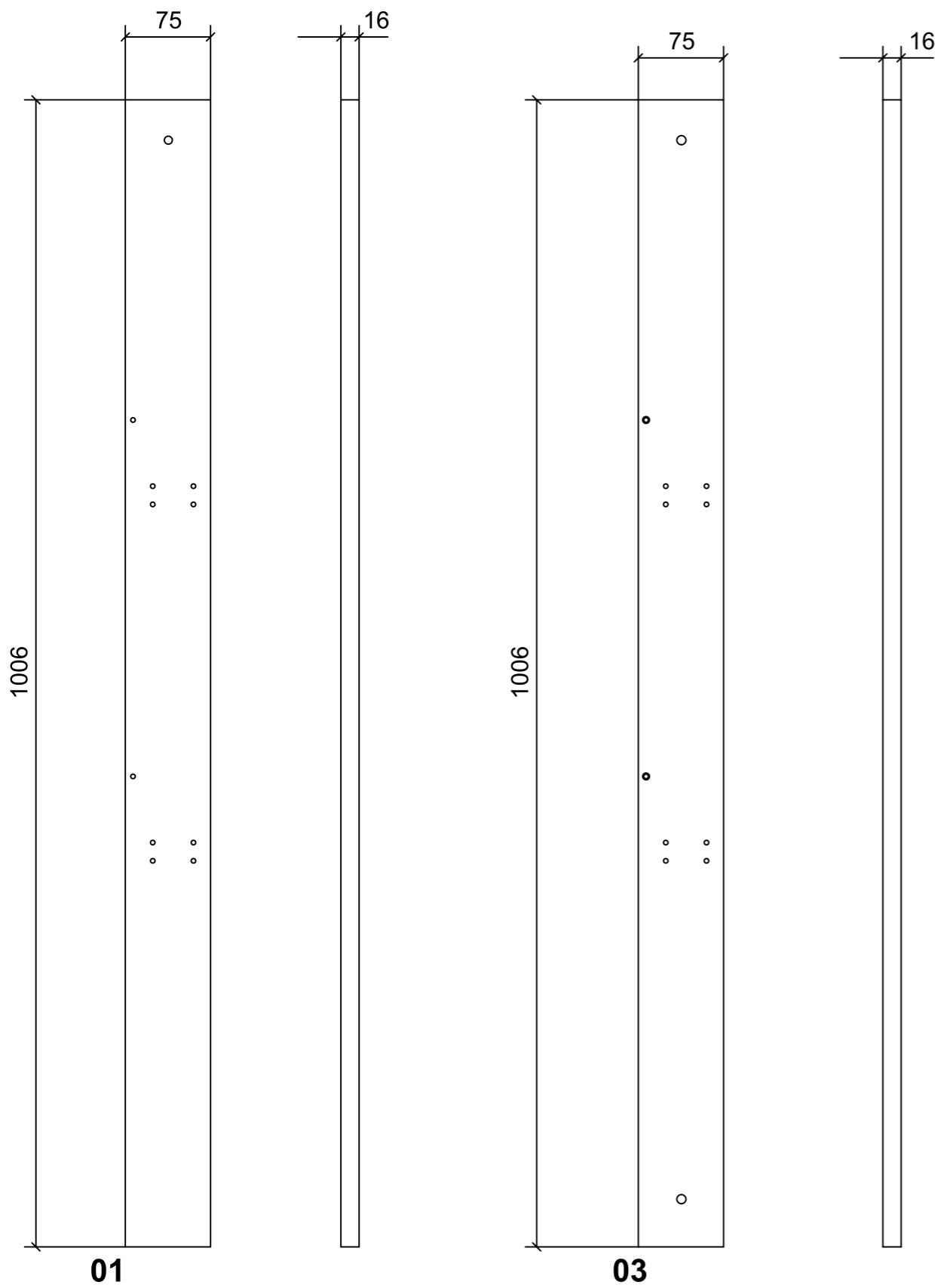

←
ELEMENTI DA MONTARE
in MF_WC01
e spedire con unico imblo

VERNICIATURA LASTRA/LACCATI:
● = VERNICIARE 1 LATO + FILI RASATI O BORDATI NESSUN SIMBOLO = VERNICIARE 2 LATI + FILI RASATI O BORDATI

LOCALE	CODICE	DESCRIZIONE COMPONENTE	FINITURA	GR.
BAGNO ARMATORE	MD320_R04_WC01	MOBILE IN NICCHIA SOPRA LAVABO	IROKO DOGATO	2

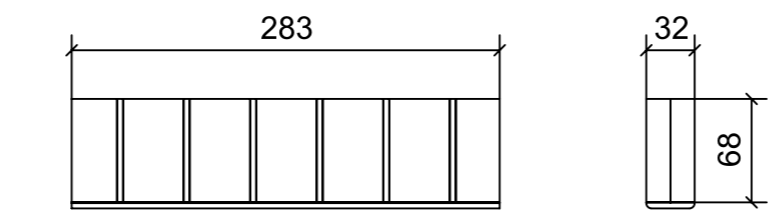
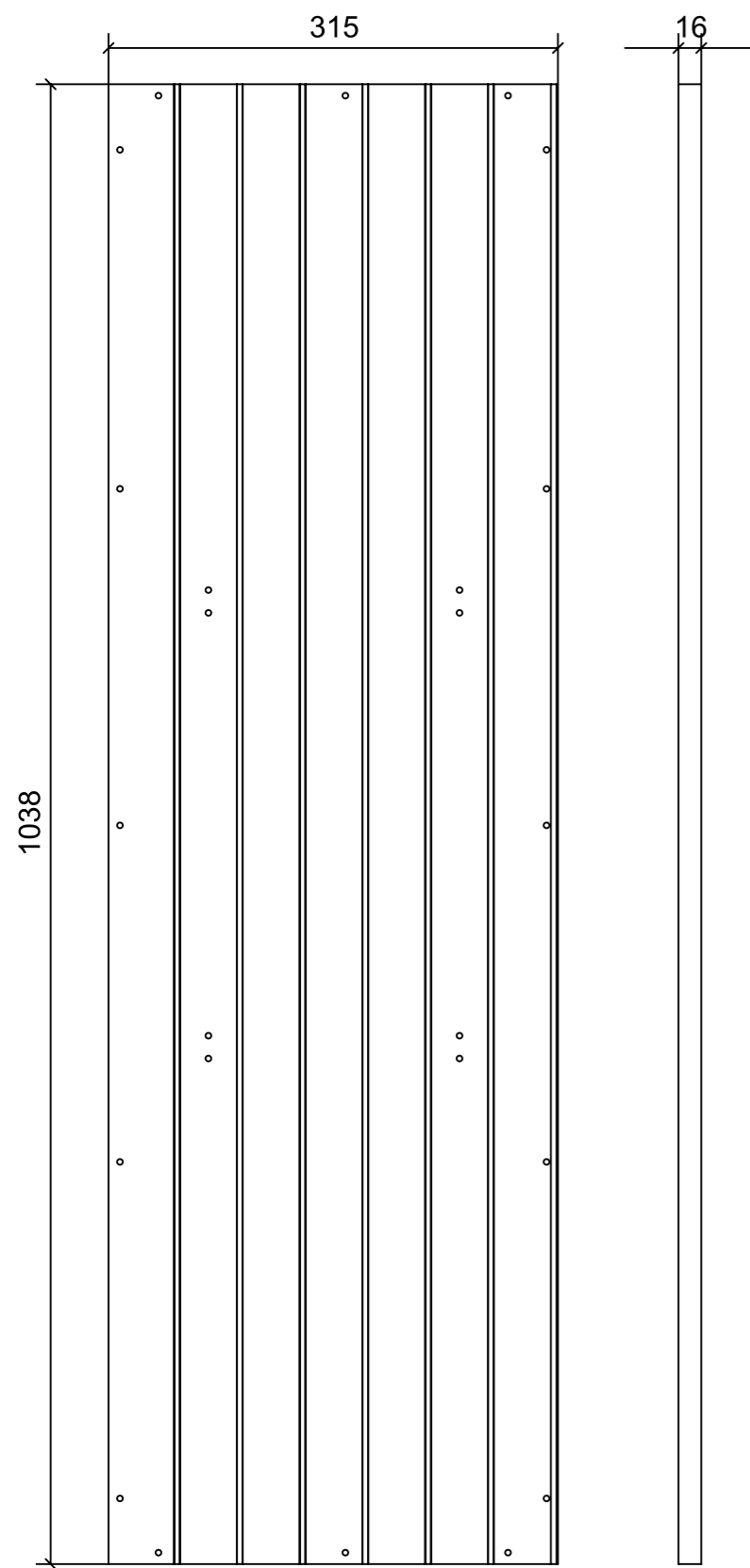

02

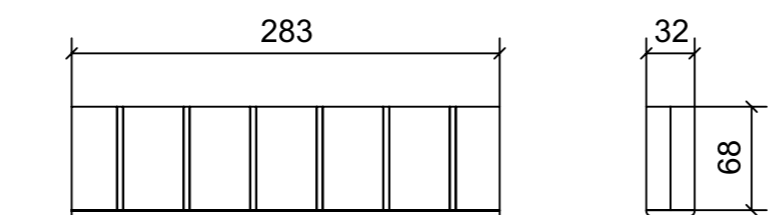

03

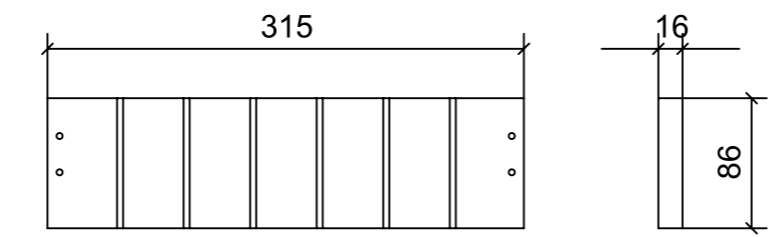

04

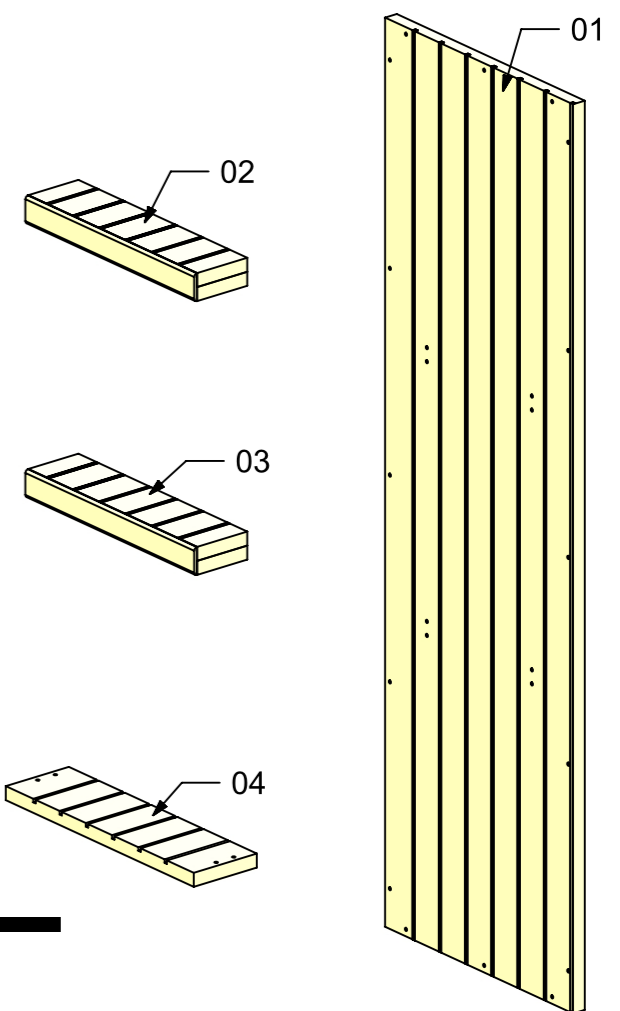
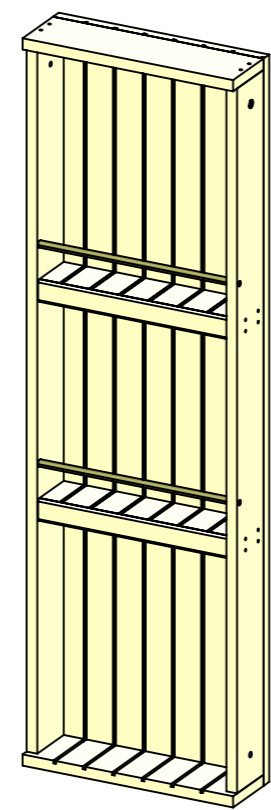

ELEMENTI DA MONTARE
in MF_WC01
e spedire con unico imblo

VERNICIATURA LASTRA/LACCATI:

● = VERNICIARE 1 LATO + FILI RASATI O BORDATI

NESSUN SIMBOLO = VERNICIARE 2 LATI + FILI RASATI O BORDATI

LOCALE	CODICE	DESCRIZIONE COMPONENTE	FINITURA	GR.
BAGNO ARMATORE	MD320_R04_WE01	SCATOLA CORPO MISCELATORI	IROKO DOGATO	3

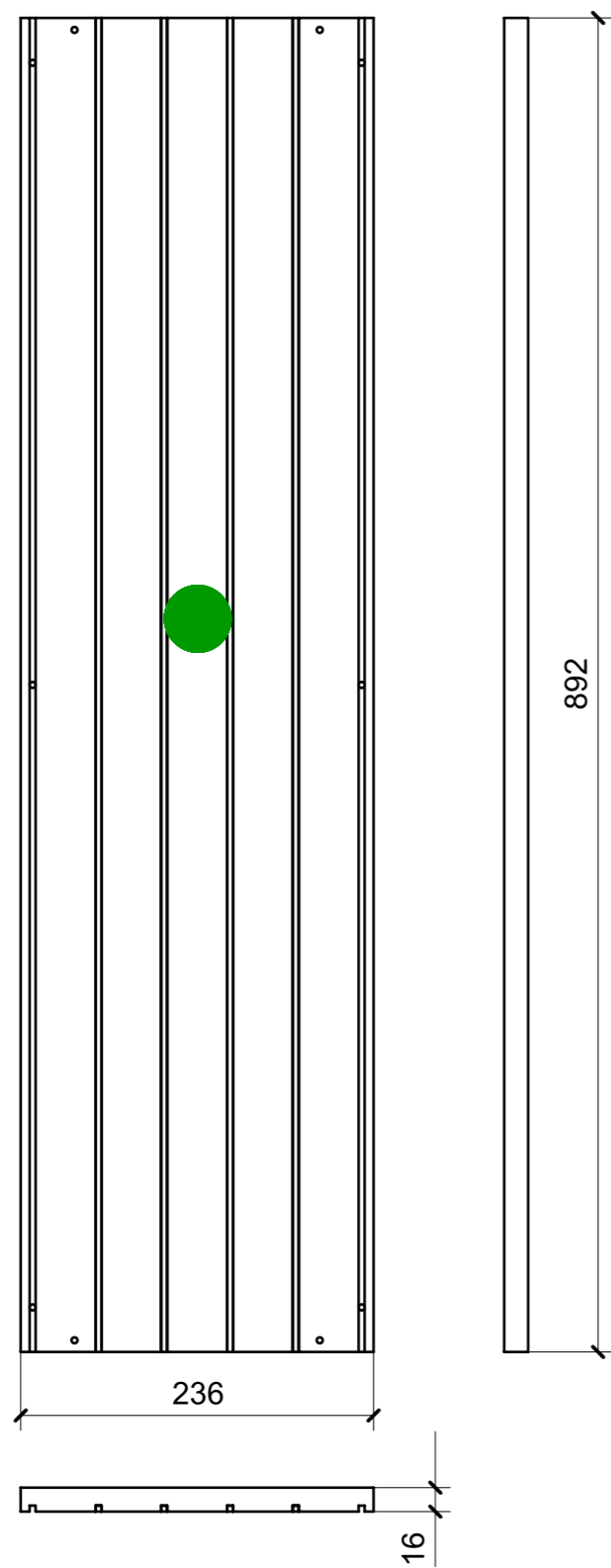

ELEMENTO DA MONTARE
in MF_WE01
e spedire con unico imballo

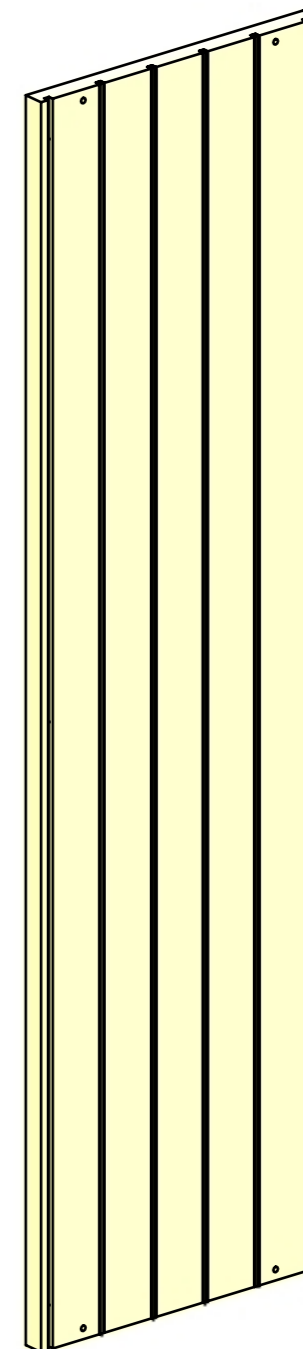

VERNICIATURA LASTRA/LACCATI:

● = VERNICIARE 1 LATO + FILI RASATI O BORDATI

NESSUN SIMBOLO = VERNICIARE 2 LATI + FILI RASATI O BORDATI

LOCALE	CODICE	DESCRIZIONE COMPONENTE	FINITURA	GR.
BAGNO ARMATORE	MD320_R01_WF01	MURATA SX DOCCIA	LASTRA SCURA	2

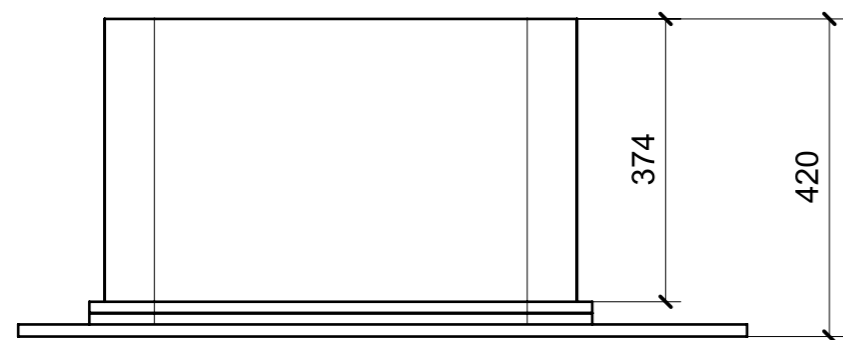
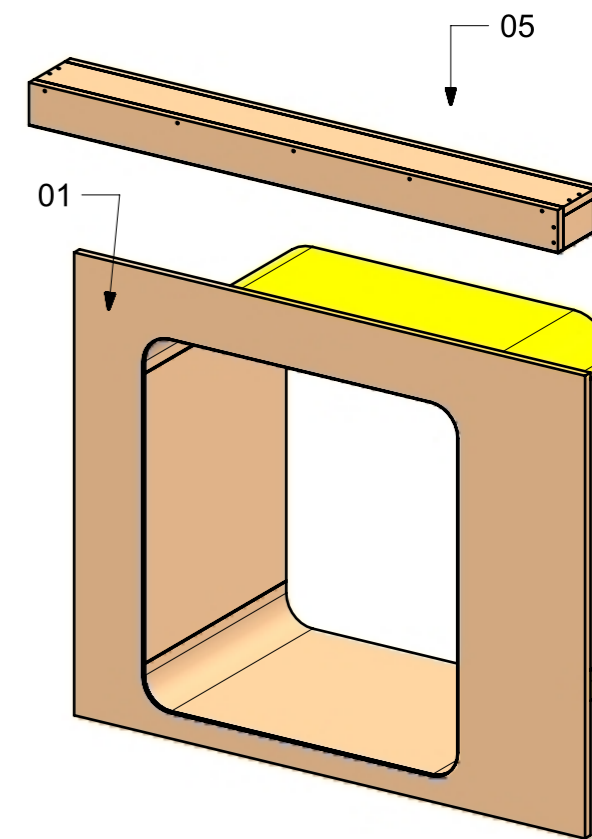
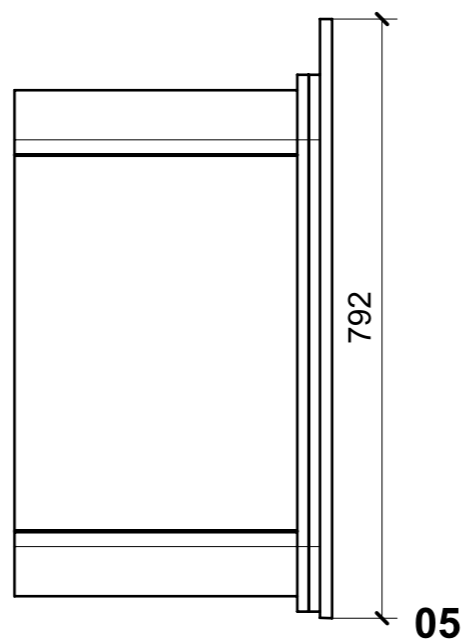
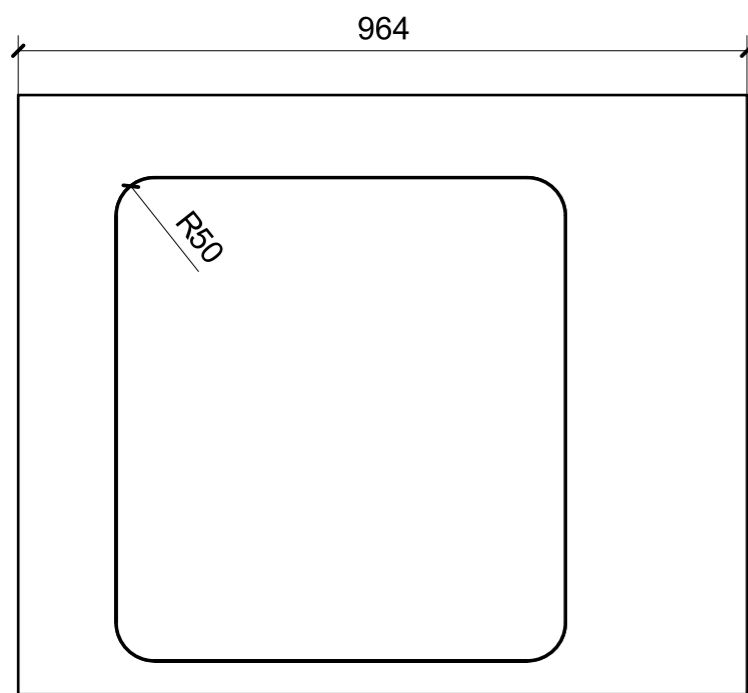

01

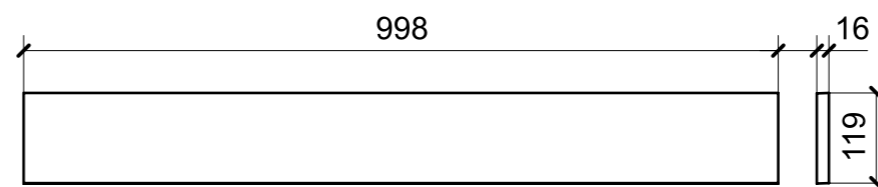

03

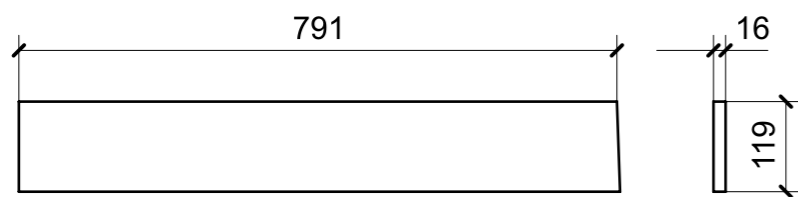
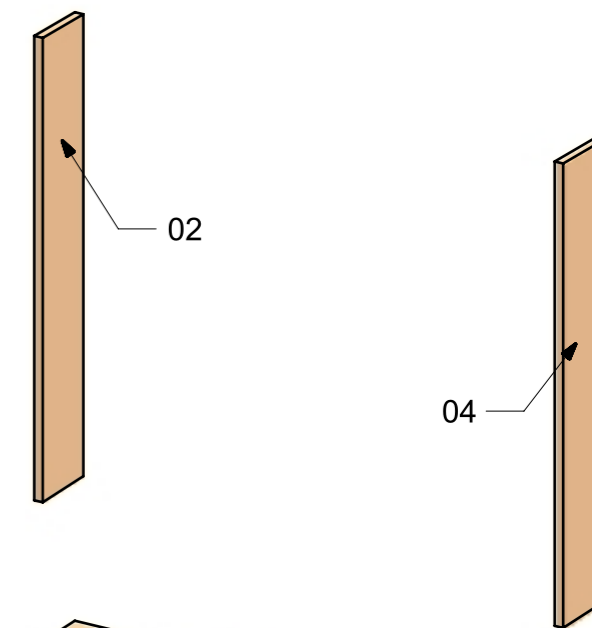

02

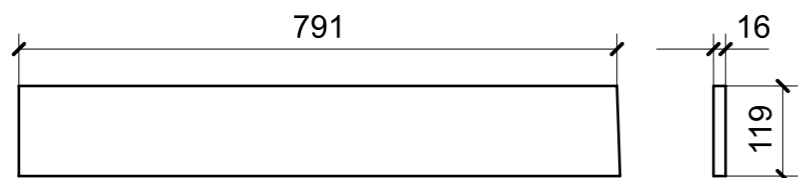
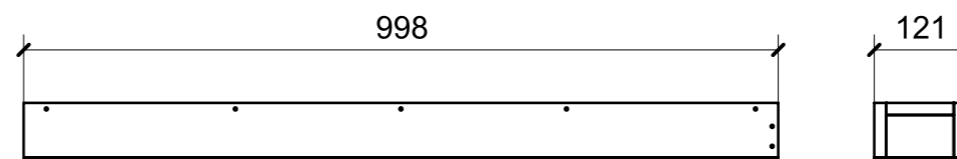

04

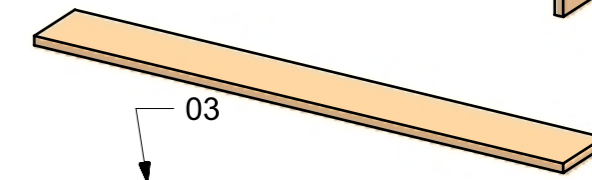
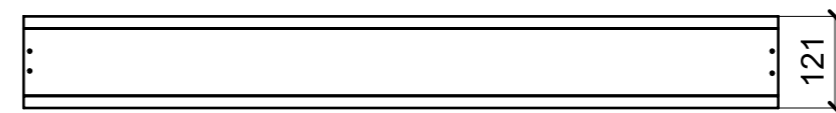

VERNICIATURA LASTRA/LACCATI:

● = VERNICIARE 1 LATO + FILI RASATI O BORDATI

NESSUN SIMBOLO = VERNICIARE 2 LATI + FILI RASATI O BORDATI

LOCALE	CODICE	DESCRIZIONE COMPONENTE	FINITURA	GR.
BAGNO ARMATORE	MD320_R02_WG01	PARETE PORTA SCORREVOLE VAR.1-2	LASTRA CHIARA	4

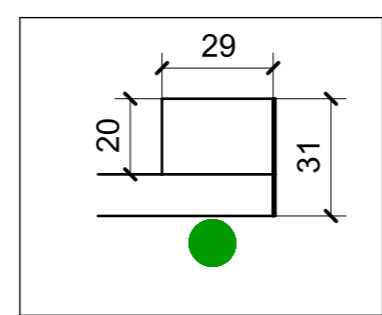
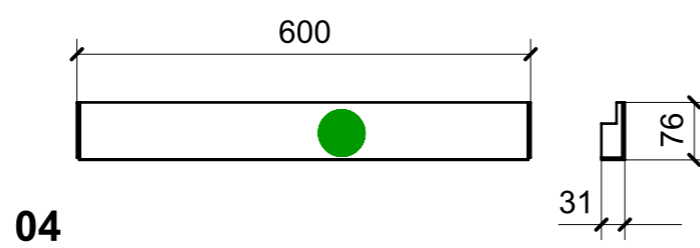
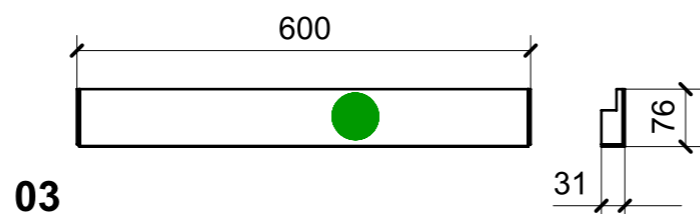
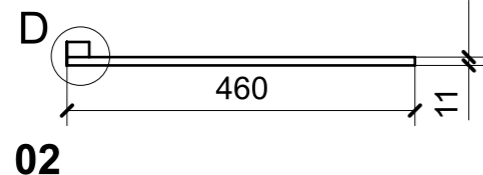
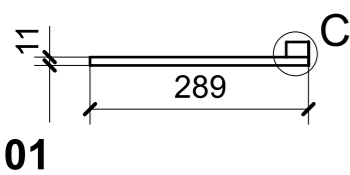
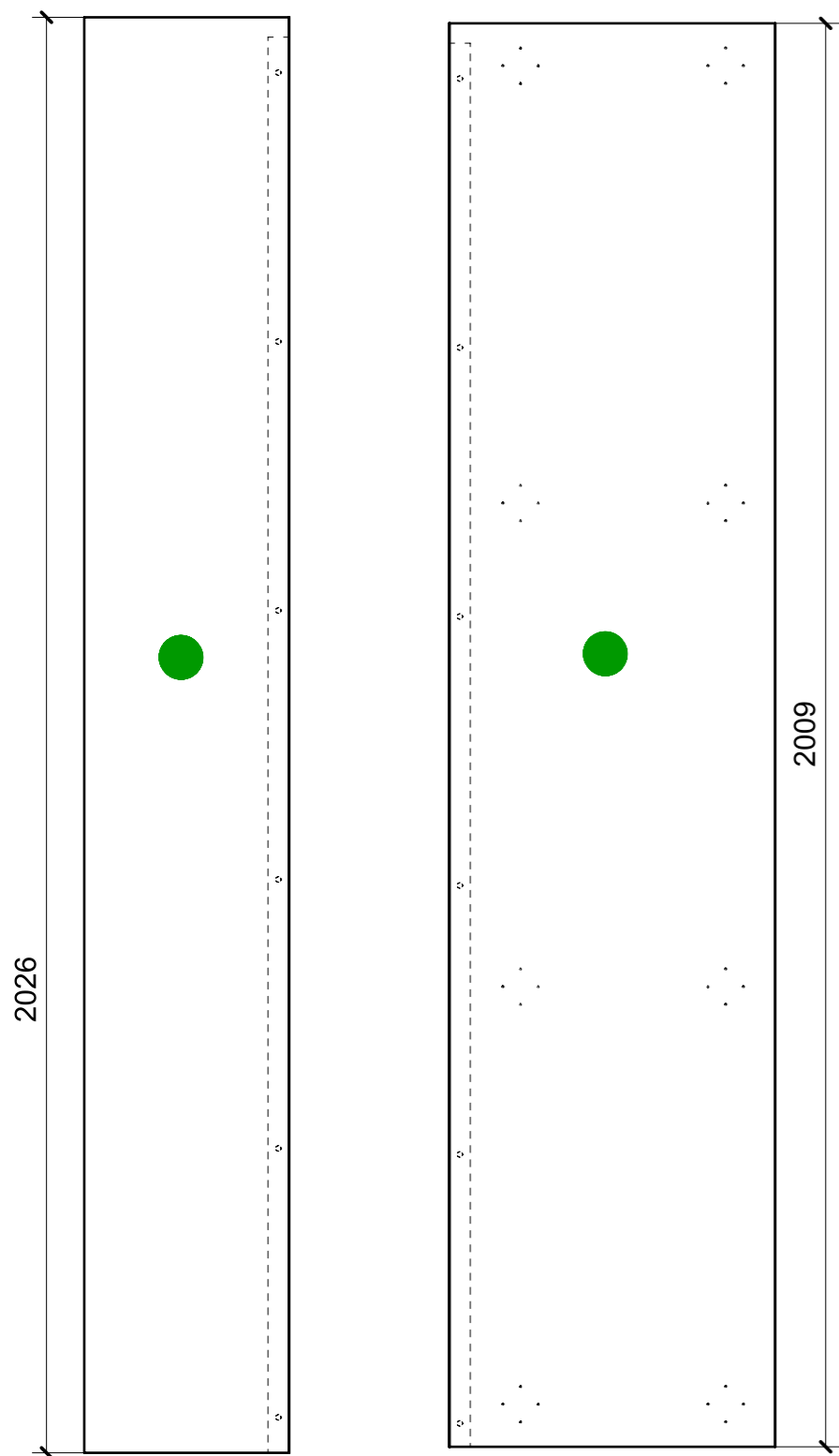

DETAIL C
SCALE 1:2

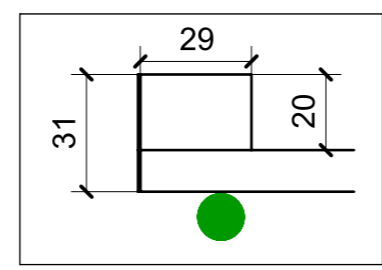

DETAIL D
SCALE 1:2

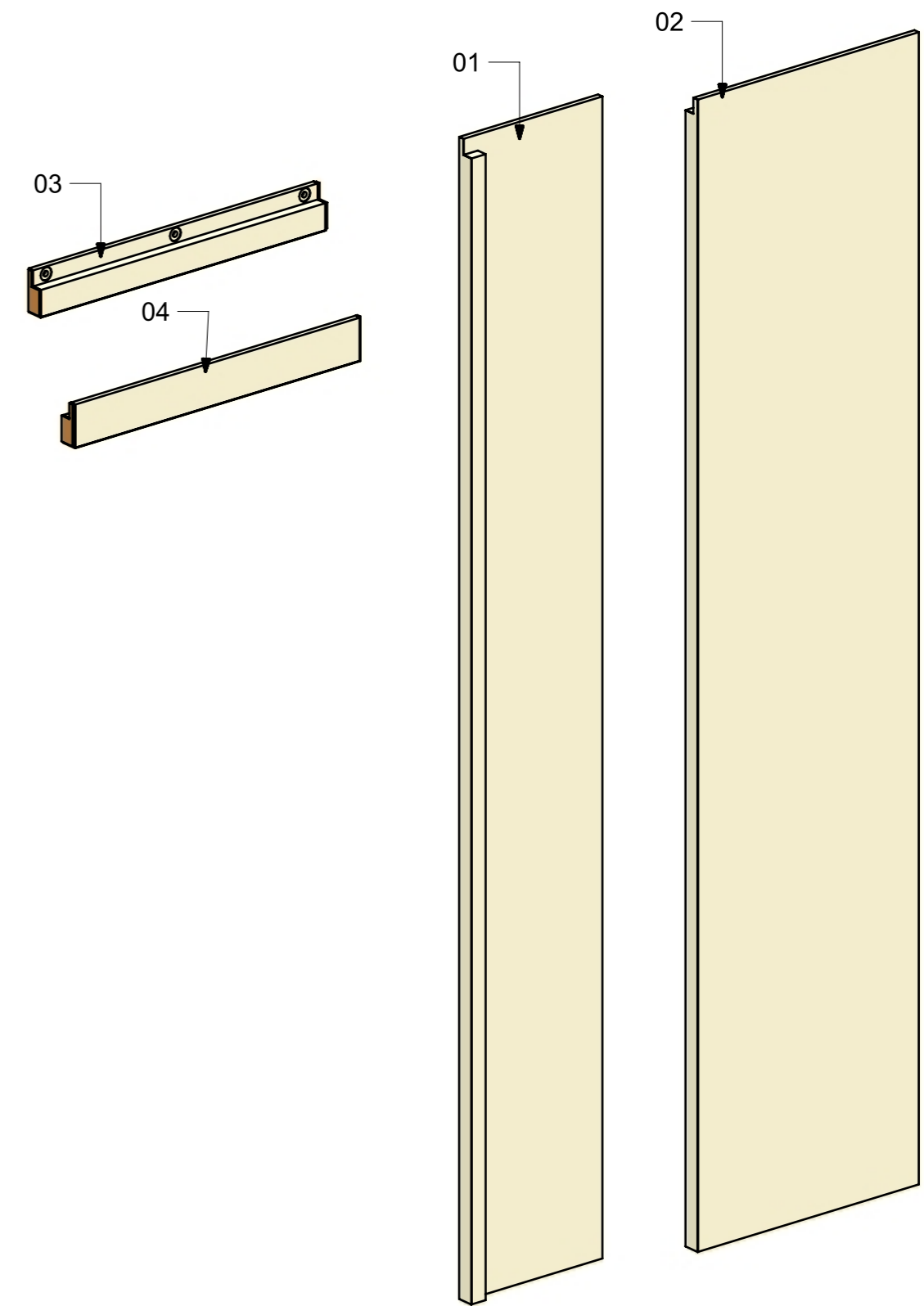

FERRAMENTA	QTY
FITLOCK M_MASCHERPA_3MM_6020202101	8
MS INCASSO_ITALVIPLA_972_FMPC_M1B	6

VERNICIATURA LASTRA/LACCATI:
● = VERNICIARE 1 LATO + FILI RASATI O BORDATI NESSUN SIMBOLO = VERNICIARE 2 LATI + FILI RASATI O BORDATI

LOCALE	CODICE	DESCRIZIONE COMPONENTE	FINITURA	GR.
BAGNO ARMATORE	MD320_R02_WWG01	PARETE PORTA SCORREVOLE VAR.3-4	LASTRA CHIARA	PTP

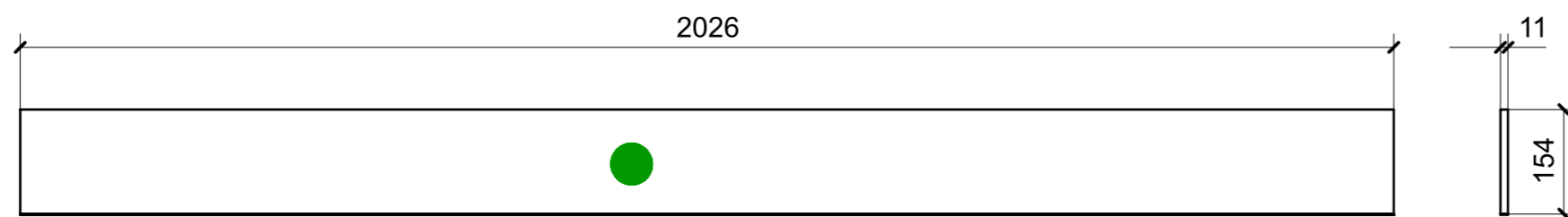
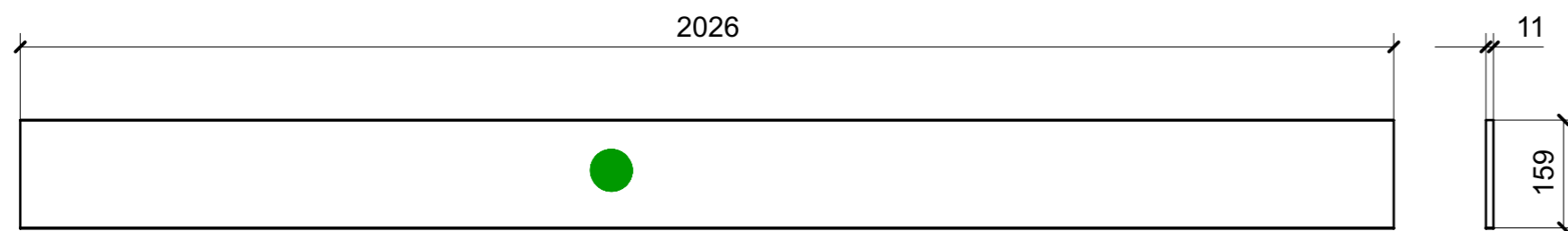

02

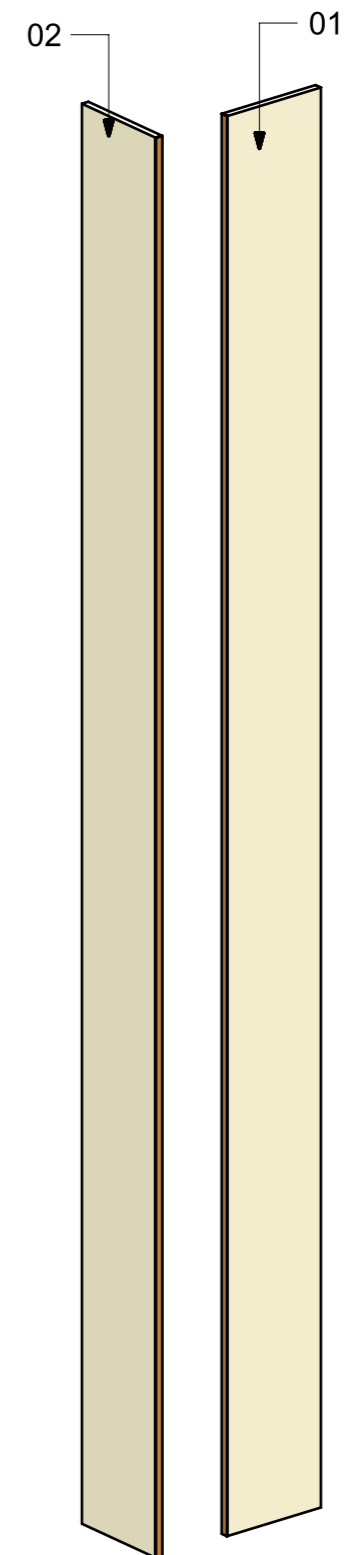

VERNICIATURA LASTRA/LACCATI:

● = FILI RASATI

● = VERNICIARE 1 LATO + FILI RASATI O BORDATI

NESSUN SIMBOLO = VERNICIARE 2 LATI + FILI RASATI O BORDATI

LOCALE	CODICE	DESCRIZIONE COMPONENTE	FINITURA	GR.
BAGNO ARMATORE	MD320_R02_WH01	PARETE NICCHIA WATER	LASTRA CHIARA	4

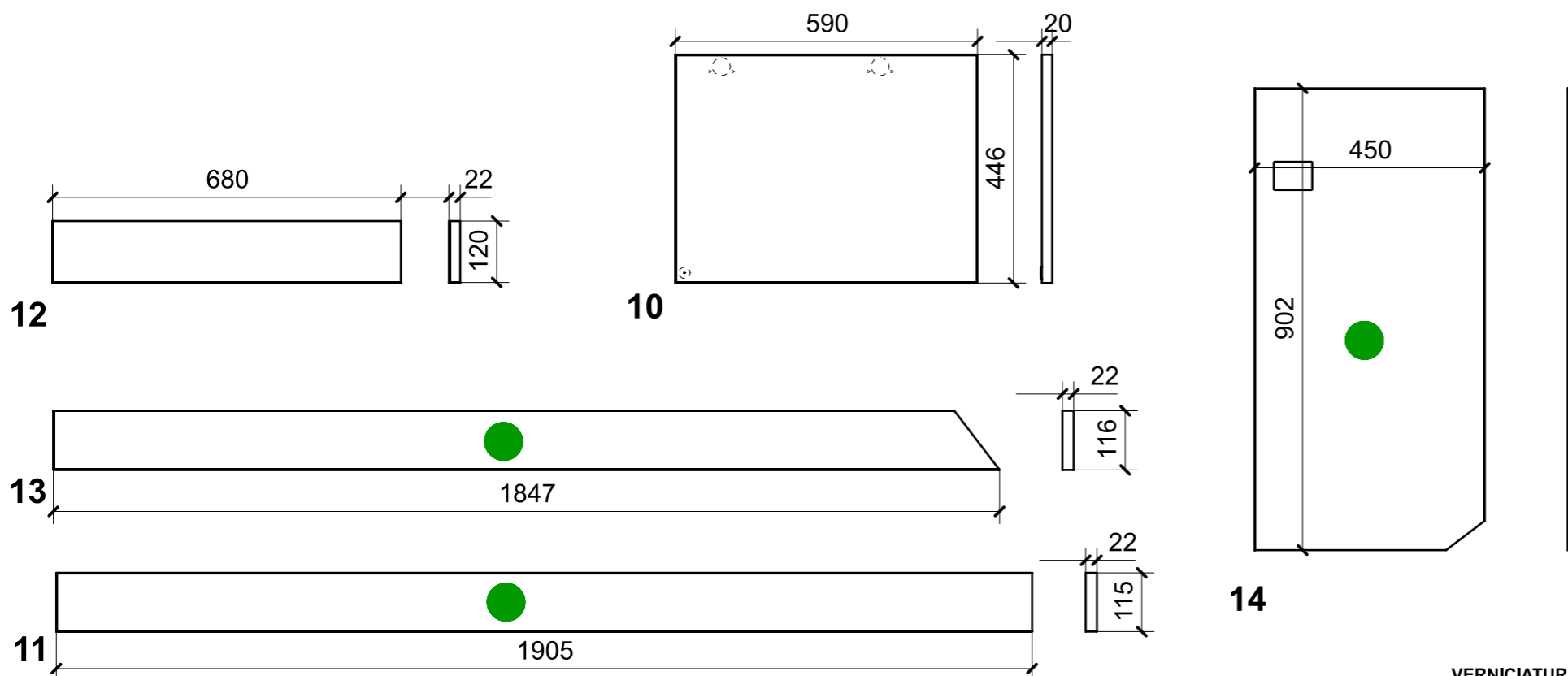
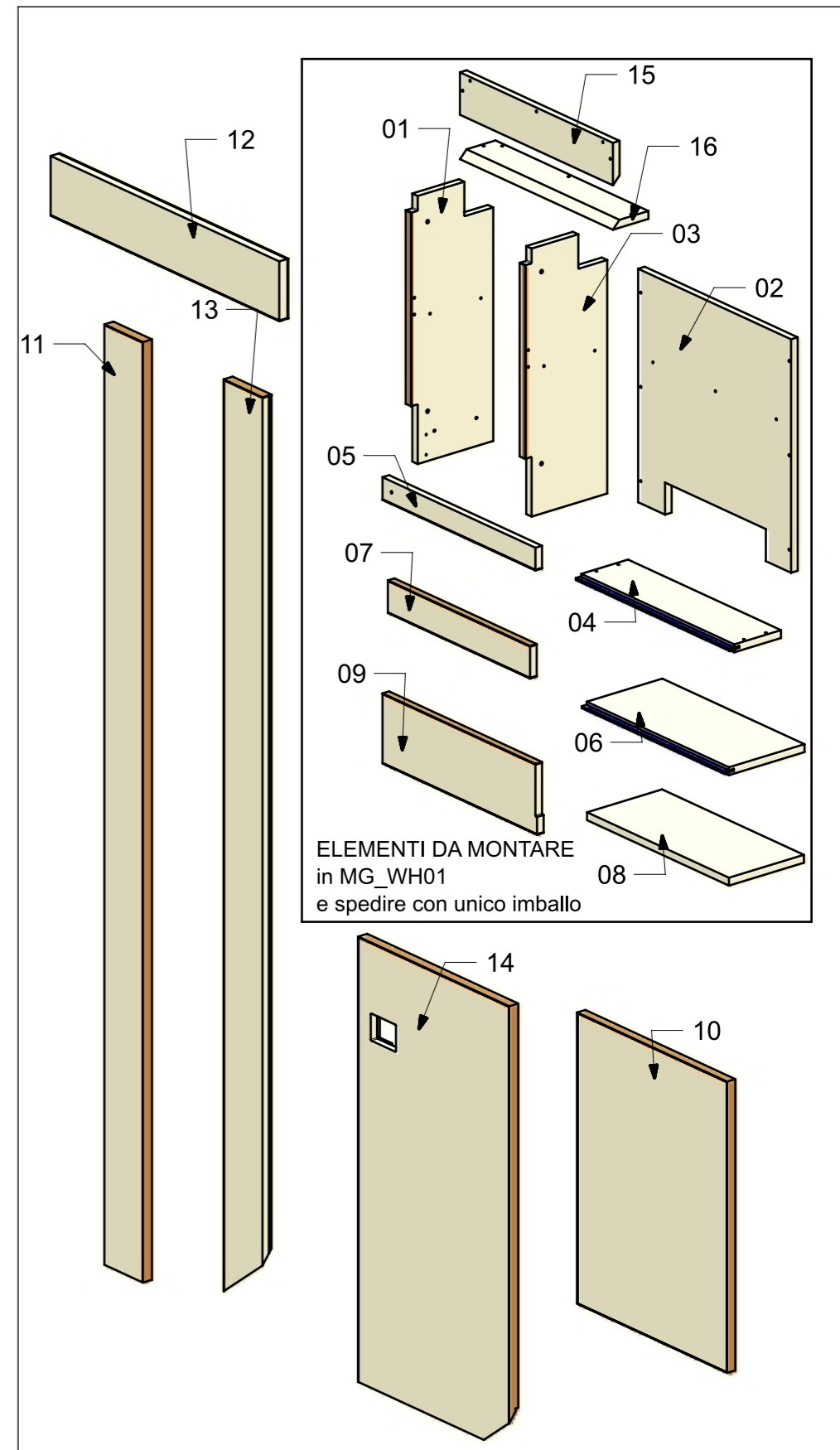
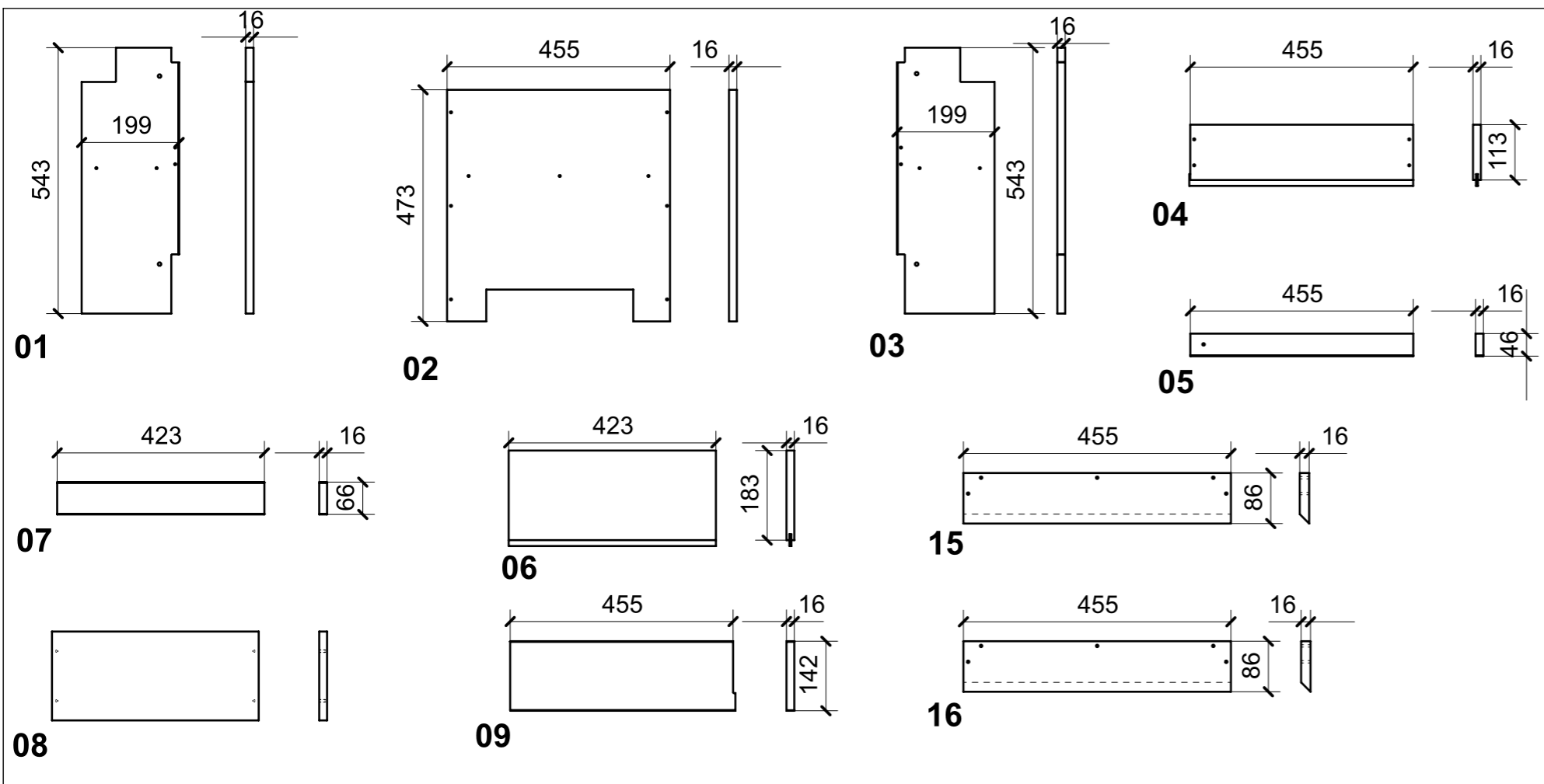

VERNICIATURA LASTRA/LACCATI:

● = VERNICIARE 1 LATO + FILI RASATI O BORDATI

NESSUN SIMBOLO = VERNICIARE 2 LATI + FILI RASATI O BORDATI

LOCALE	CODICE	DESCRIZIONE COMPONENTE	FINITURA	GR.
BAGNO ARMATORE	MD320_R03_WH01	PARETE NICCHIA WATER	IROKO	4

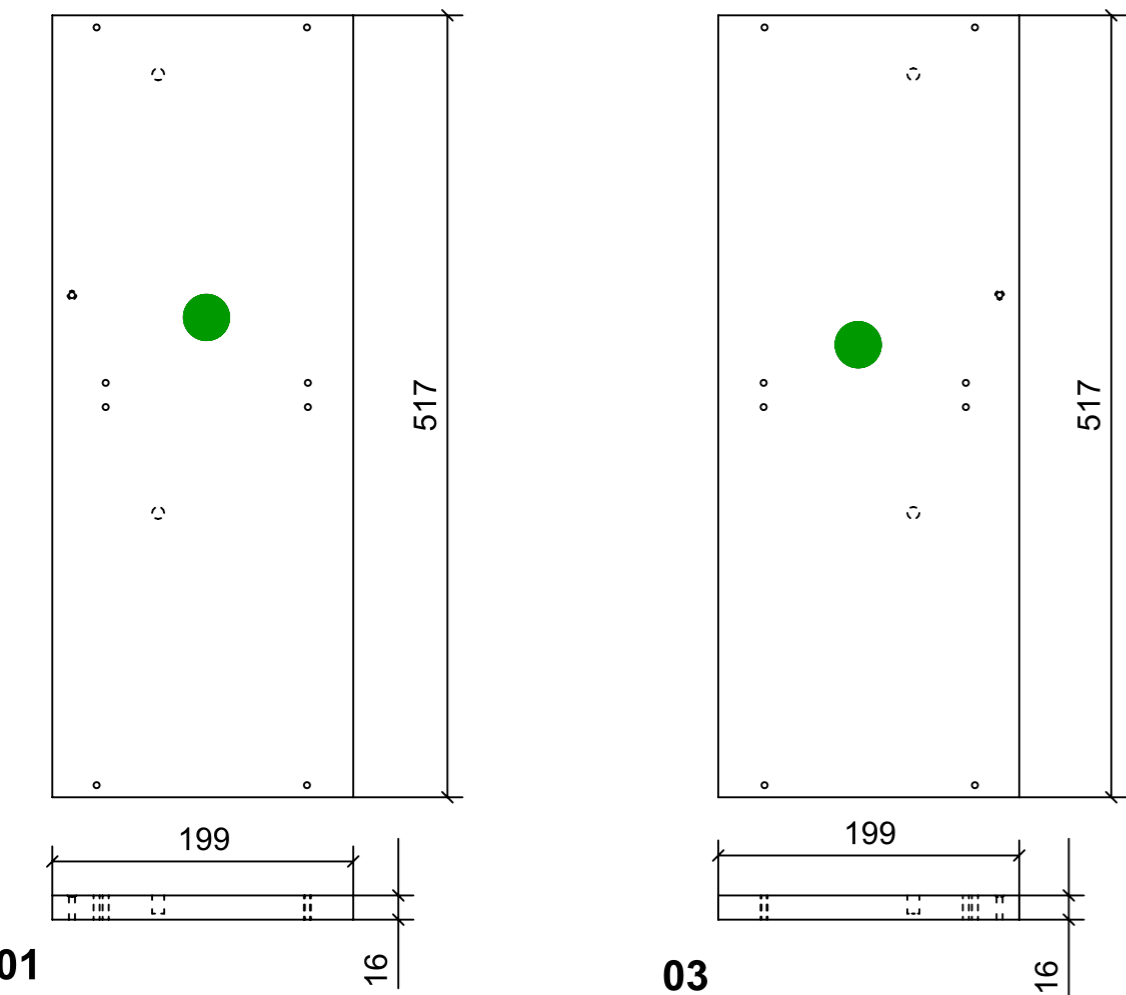

01

03

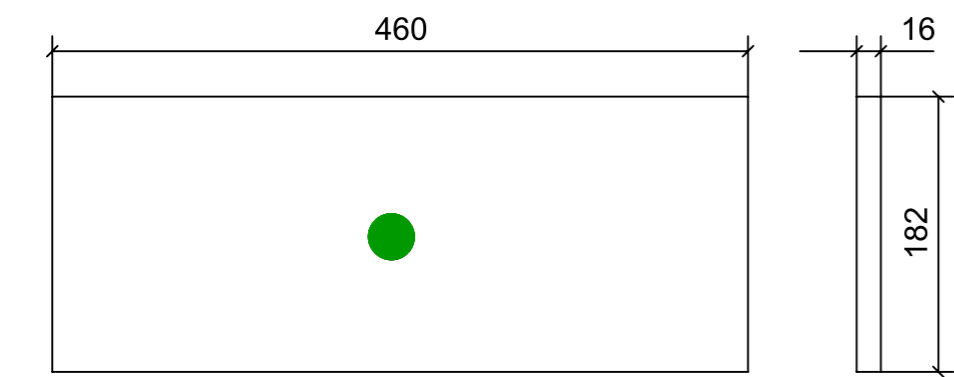

02

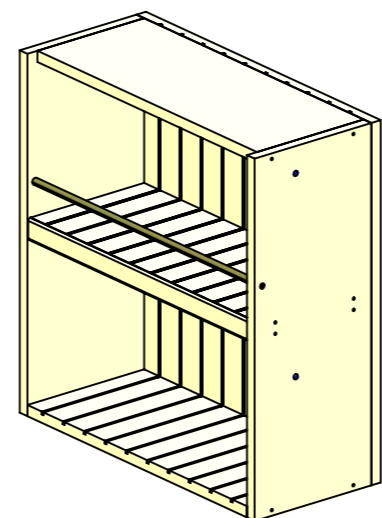

ELEMENTI DA MONTARE
in MF_WH01
e spedire con unico imballo

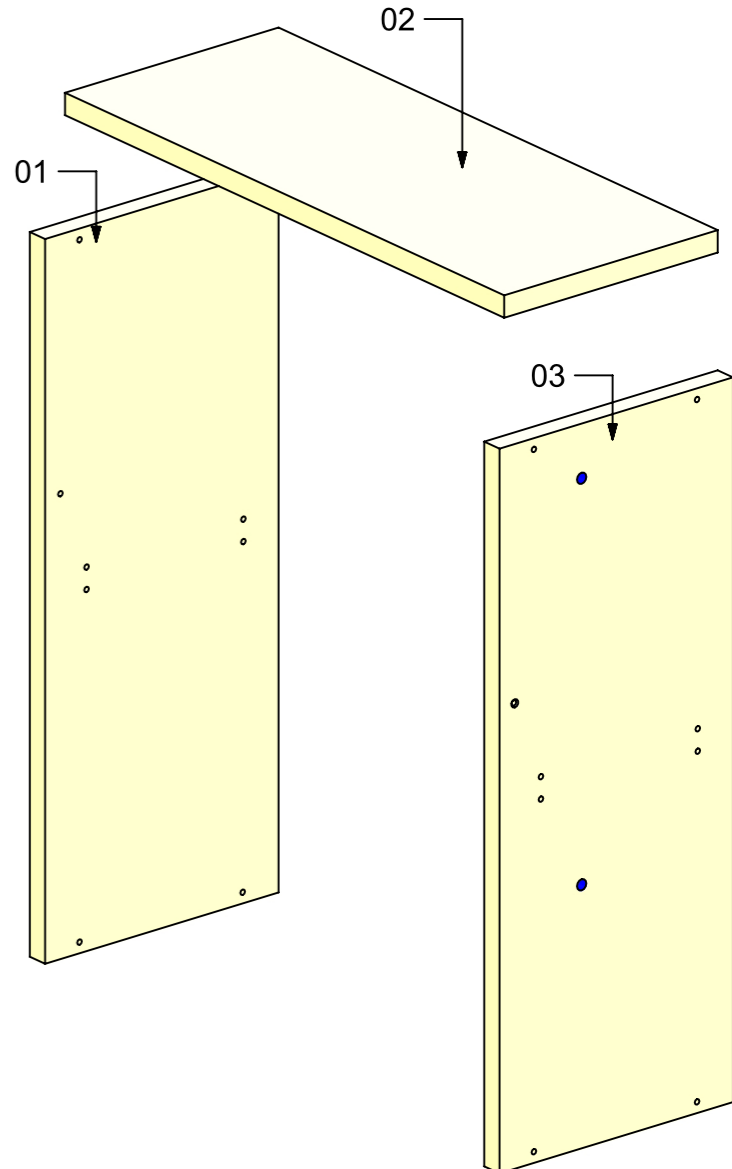

VERNICIATURA LASTRA/LACCATI:
 ● = VERNICIARE 1 LATO + FILI RASATI O BORDATI NESSUN SIMBOLO = VERNICIARE 2 LATI + FILI RASATI O BORDATI

LOCALE	CODICE	DESCRIZIONE COMPONENTE	FINITURA	GR.
BAGNO ARMATORE	MD320_R04_WH01	PARETE NICCHIA WATER	IROKO DOGATO	4

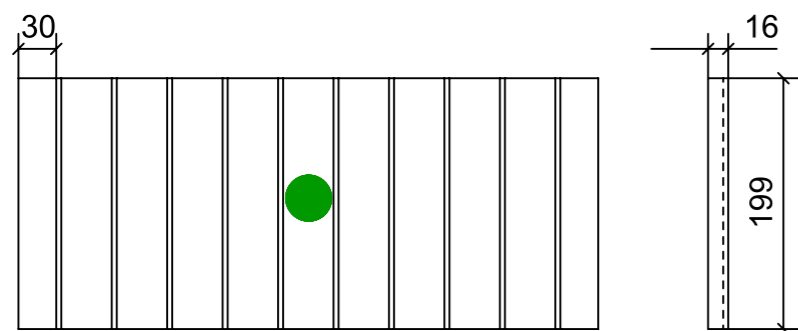
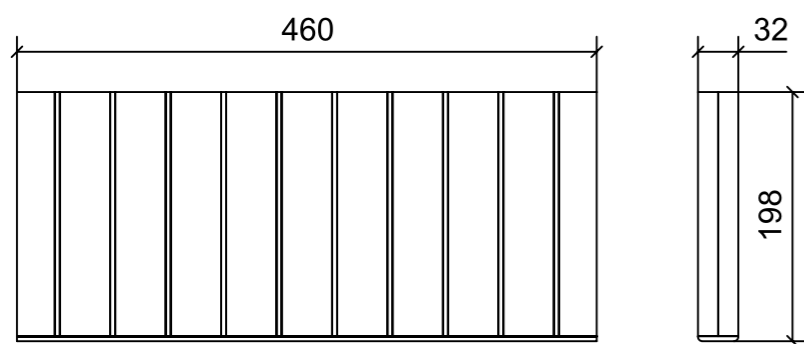
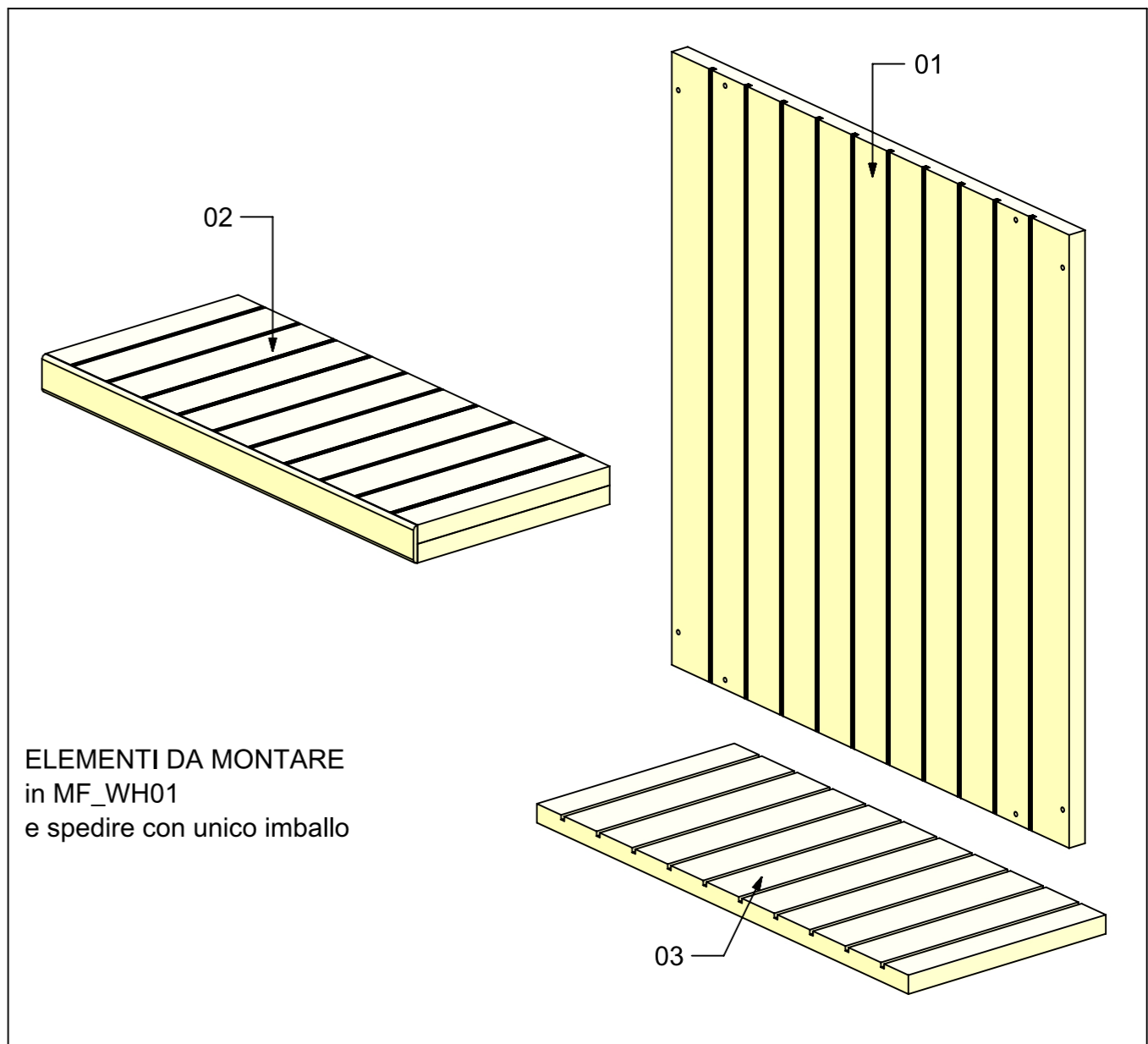
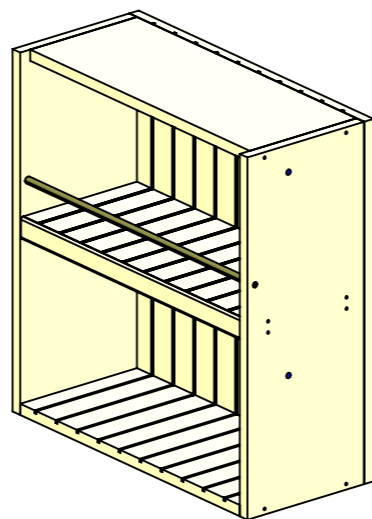
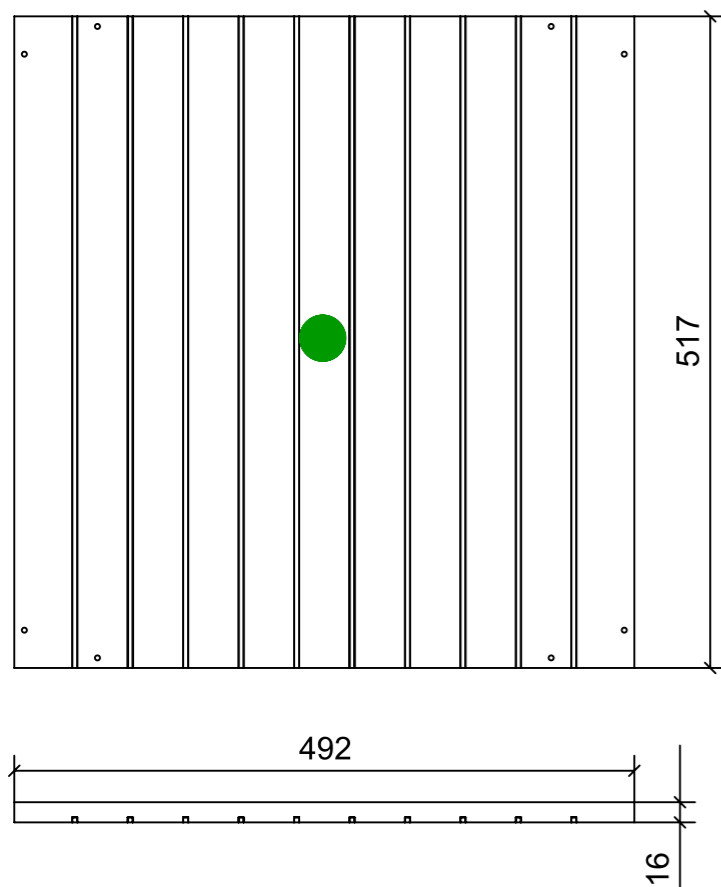

VERNICIATURA LASTRA/LACCATI:

● = VERNICIARE 1 LATO + FILI RASATI O BORDATI

NESSUN SIMBOLO = VERNICIARE 2 LATI + FILI RASATI O BORDATI

LOCALE	CODICE	DESCRIZIONE COMPONENTE	FINITURA	GR.
BAGNO ARMATORE	MD320_R02_WI01	PATERE WC CENTRONAVE PRUA VAR.1-3	LAISTRA CHIARA	PTP

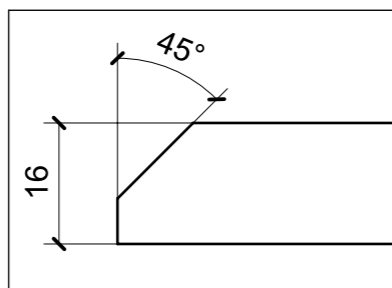
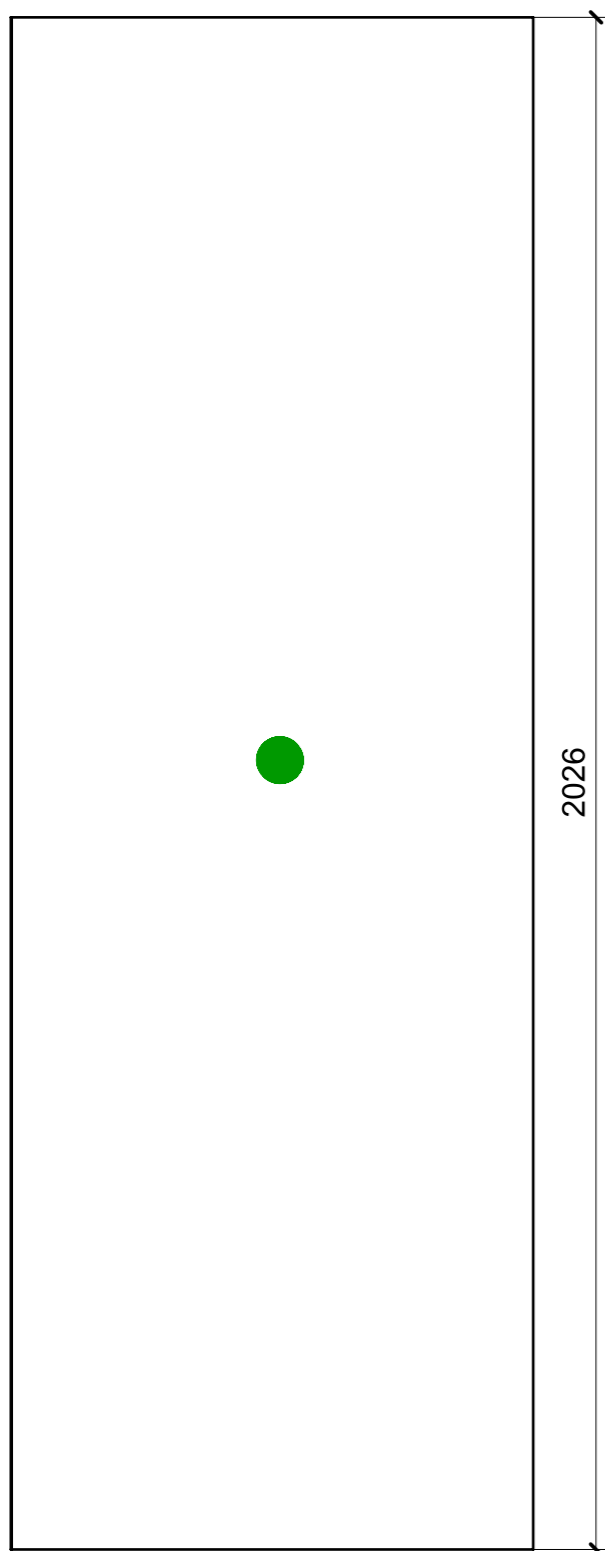

DETAIL D
SCALE 1:1

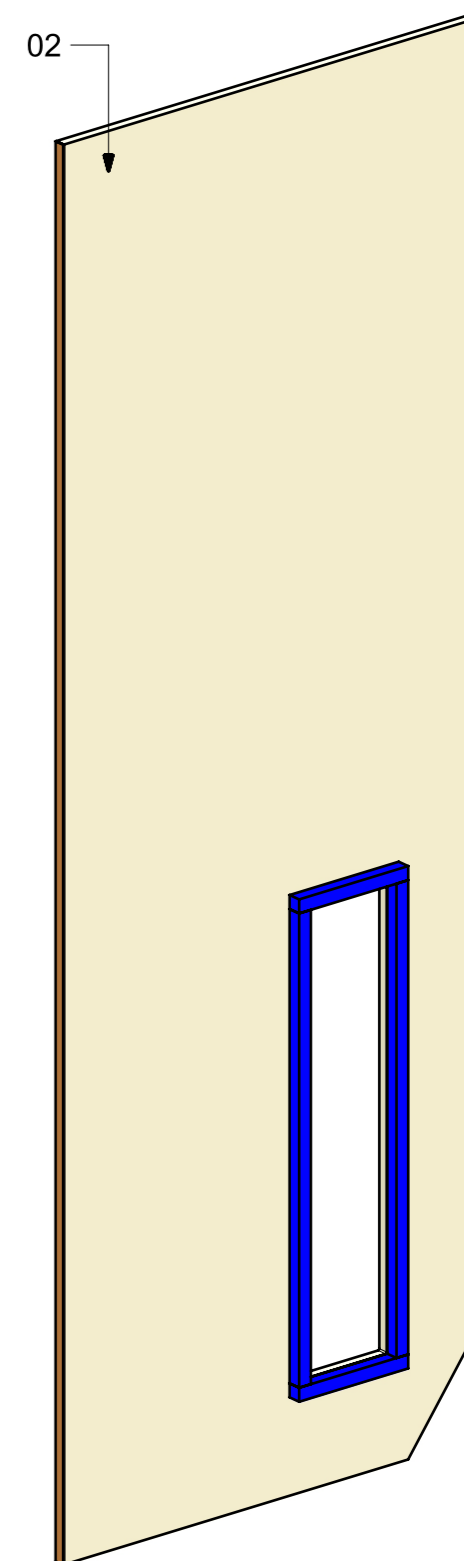
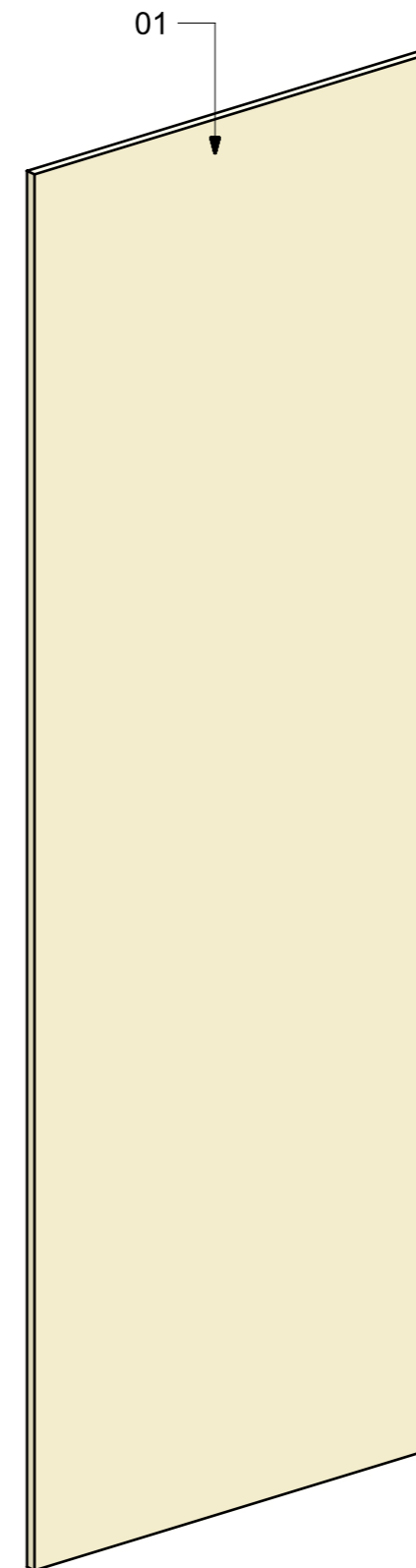
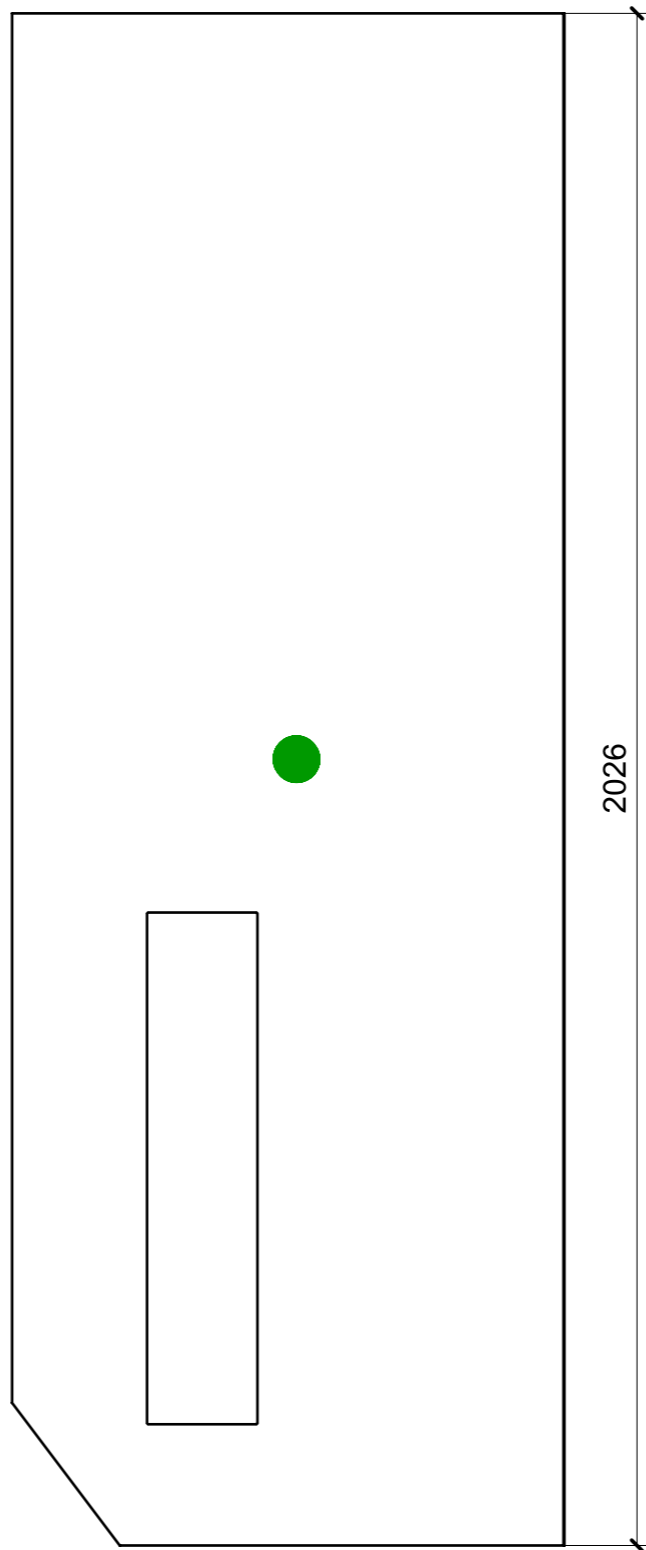

01

02

VERNICIATURA LASTRA/LACCATI:

● = FILI RASATI

● = VERNICIARE 1 LATO + FILI RASATI O BORDATI

NESSUN SIMBOLO = VERNICIARE 2 LATI + FILI RASATI O BORDATI

LOCALE	CODICE	DESCRIZIONE COMPONENTE	FINITURA	GR.
BAGNO ARMATORE	MD320_R02_WWI01	PATERE WC CENTRONAVE PRUA VAR.2-4	LASTRA CHIARA	PTP

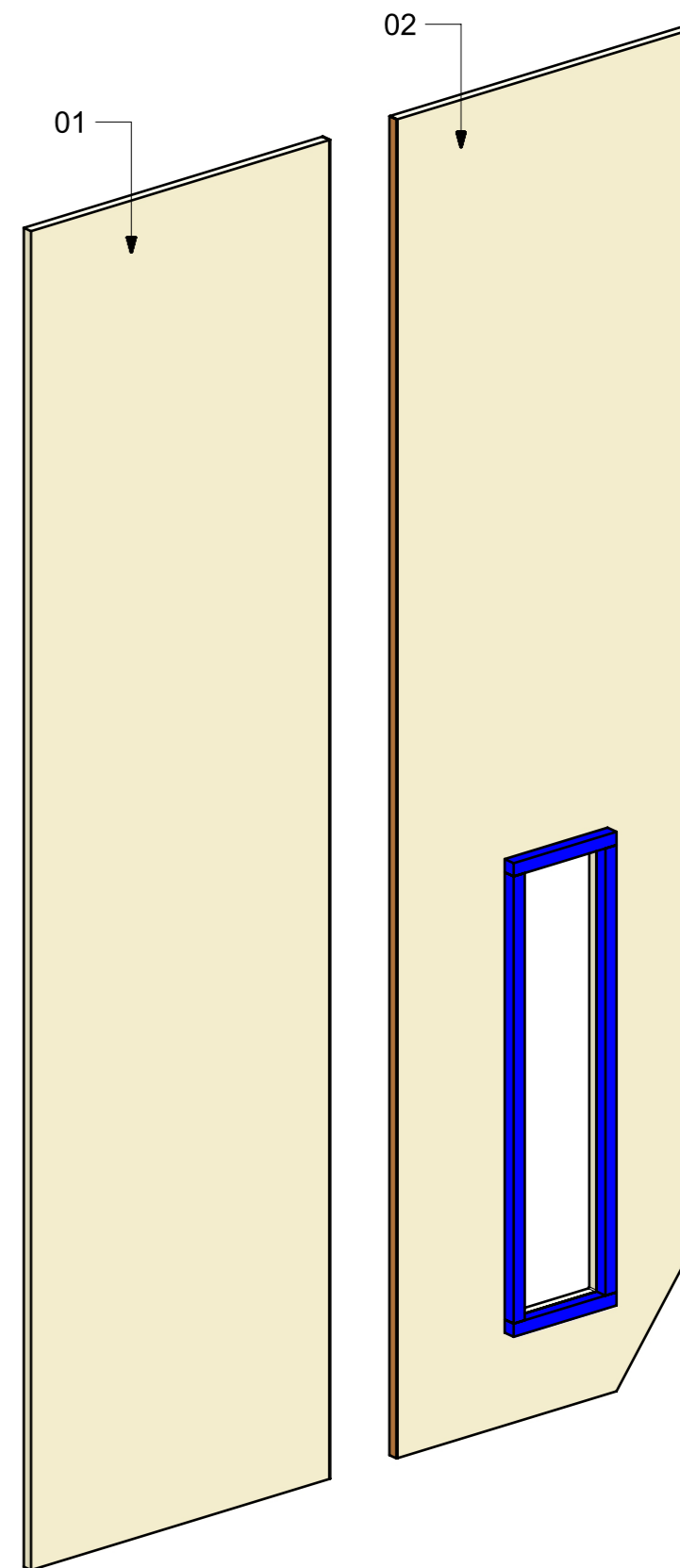
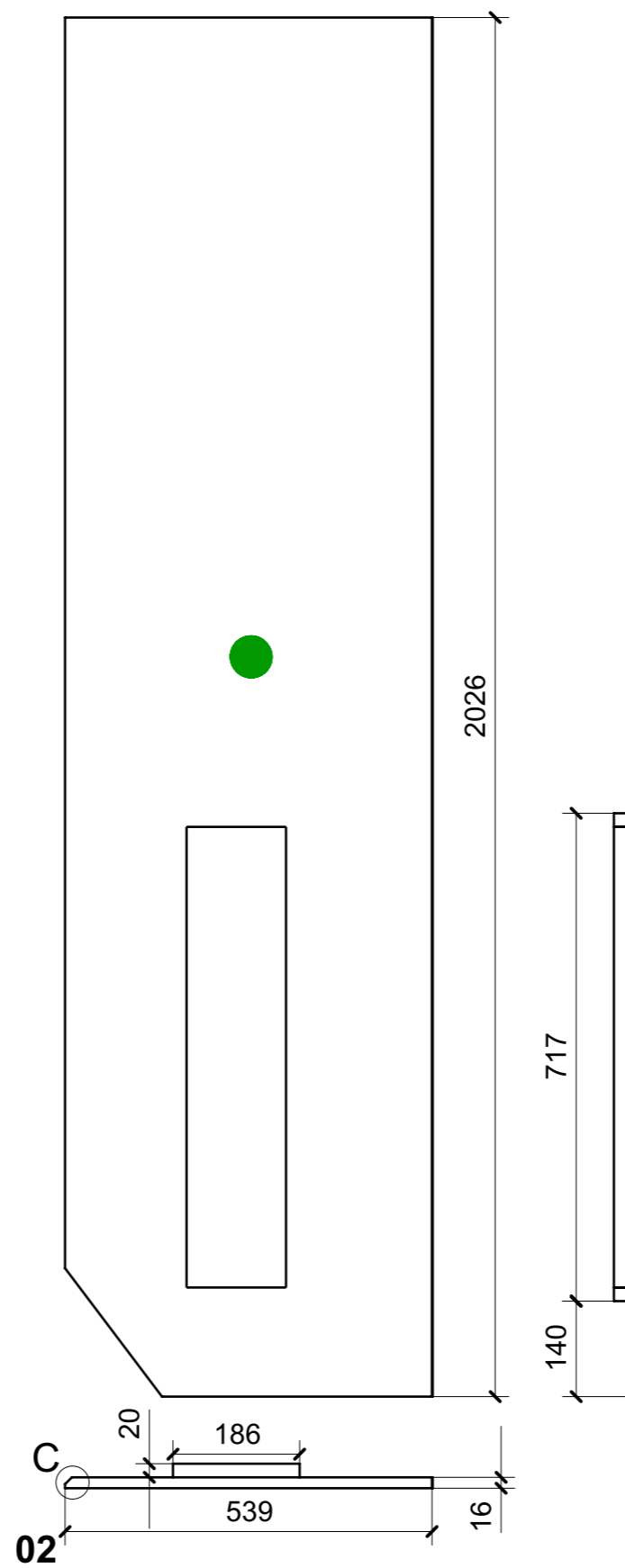
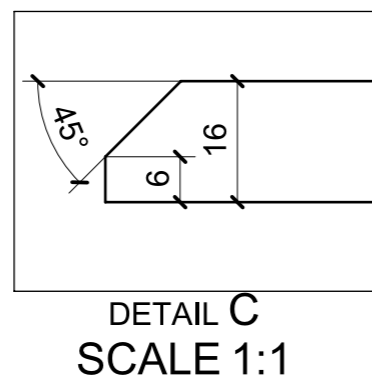
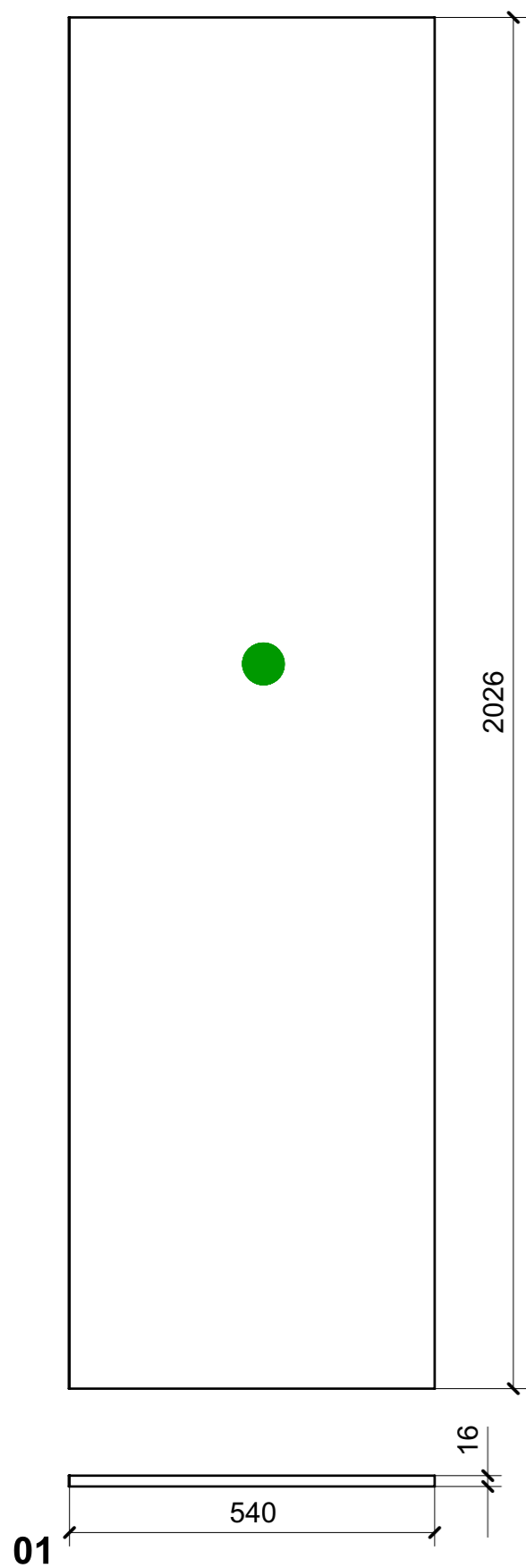

VERNICIATURA LASTRA/LACCATI:

● = FILI RASATI

● = VERNICIARE 1 LATO + FILI RASATI O BORDATI

NESSUN SIMBOLO = VERNICIARE 2 LATI + FILI RASATI O BORDATI

LOCALE	CODICE	DESCRIZIONE COMPONENTE	FINITURA	GR.
BAGNO ARMATORE	MD320_R02_WJ01	INGROSSO PARETE WC VAR.1-3	LASTRA CHIARA	2

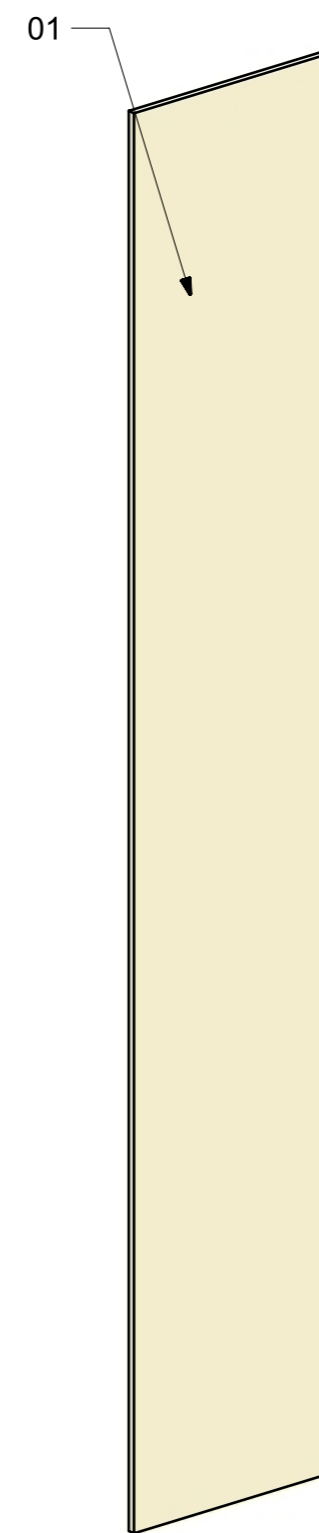
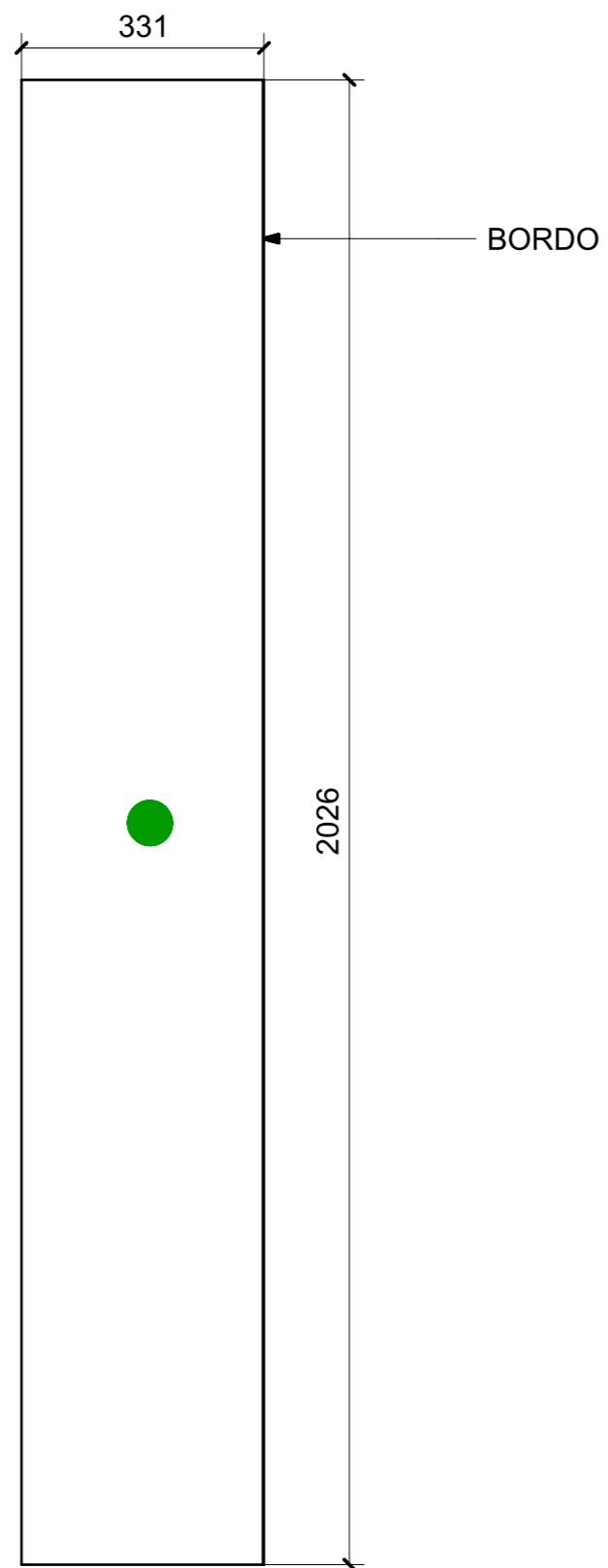

FERRAMENTA	QTY

01

VERNICIATURA LASTRA/LACCATI:

● = VERNICIARE 1 LATO + FILI RASATI O BORDATI

NESSUN SIMBOLO = VERNICIARE 2 LATI + FILI RASATI O BORDATI

LOCALE	CODICE	DESCRIZIONE COMPONENTE	FINITURA	GR.
BAGNO ARMATORE	MD320_R02_WWB01	FACCIATA INGROSSO PARETE WC VAR.3	LASTRA CHIARA	2

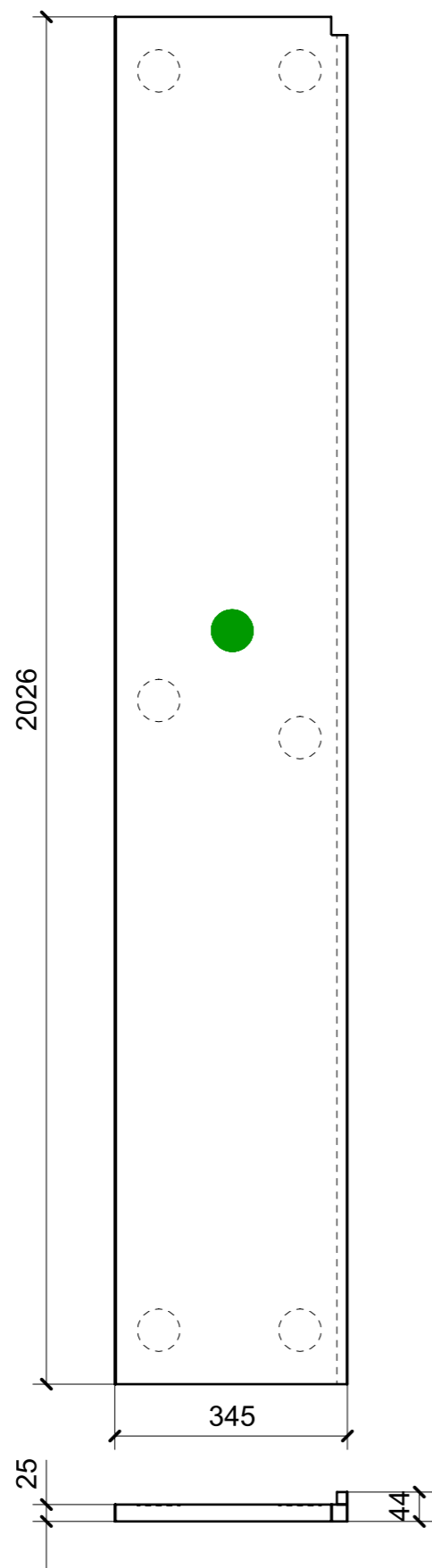

FERRAMENTA	QTY
FITLOCK M_MASCHERPA_3MM_6020202101	6

01

VERNICIATURA LASTRA/LACCATI:

● = VERNICIARE 1 LATO + FILI RASATI O BORDATI

NESSUN SIMBOLO = VERNICIARE 2 LATI + FILI RASATI O BORDATI

LOCALE	CODICE	DESCRIZIONE COMPONENTE	FINITURA	GR.
BAGNO ARMATORE	MD320_R02_WWJ01	MONTANTE INGROSSO PARETE WC VAR.3-4	LASTRA CHIARA	PTP

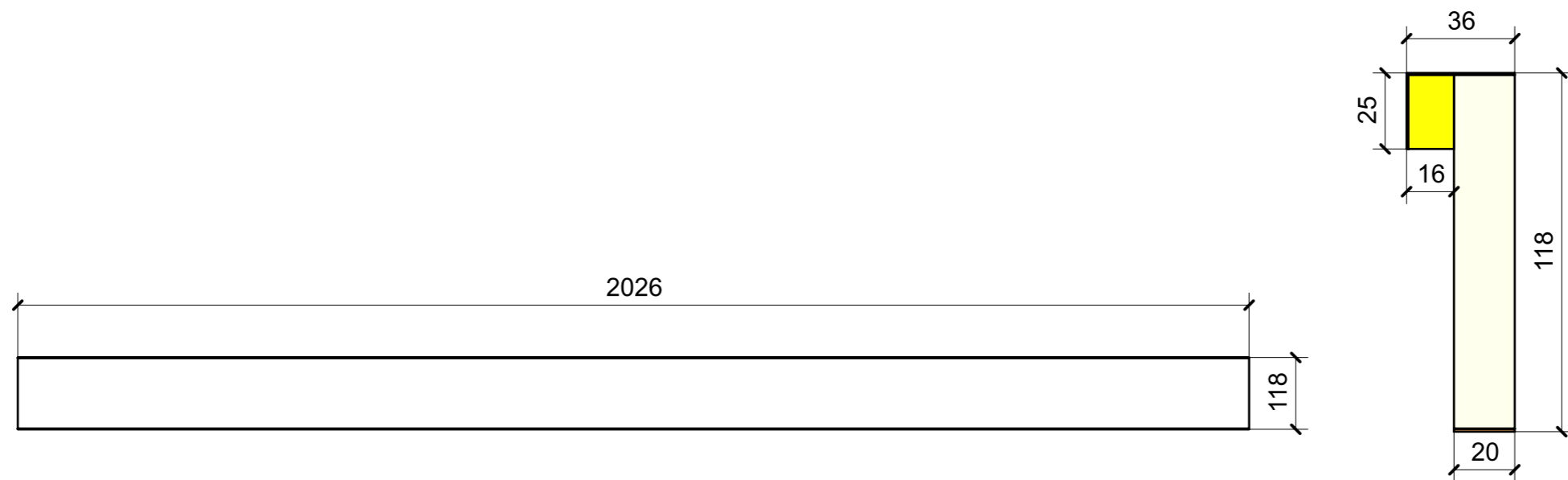

VERNICIATURA LASTRA/LACCATI:

● = FILI RASATI

● = VERNICIARE 1 LATO + FILI RASATI O BORDATI

NESSUN SIMBOLO = VERNICIARE 2 LATI + FILI RASATI O BORDATI

LOCALE	CODICE	DESCRIZIONE COMPONENTE	FINITURA	GR.
BAGNO ARMATORE	MD320_R02_WK01	RIV. PARETE DIVISORIA	LASTRA CHIARA	3

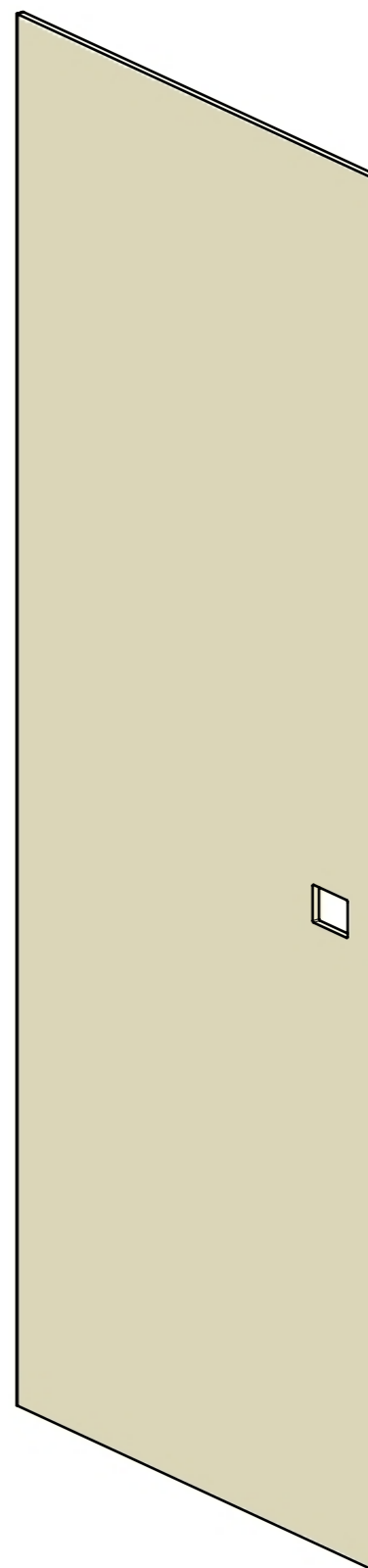
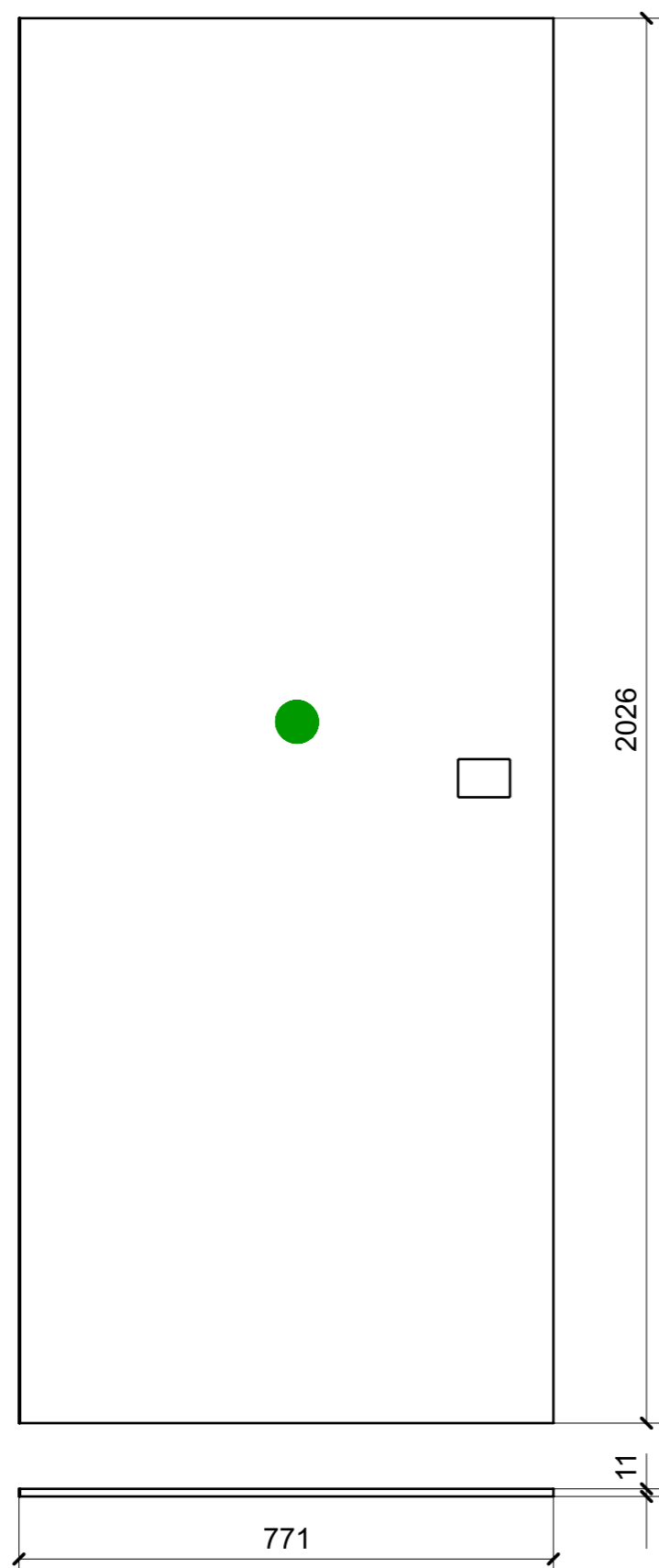

VERNICIATURA LASTRA/LACCATI:

● = VERNICIARE 1 LATO + FILI RASATI O BORDATI

NESSUN SIMBOLO = VERNICIARE 2 LATI + FILI RASATI O BORDATI

LOCALE	CODICE	DESCRIZIONE COMPONENTE	FINITURA	GR.
BAGNO ARMATORE	MD320_R04_WN01	SEDUTA DOCCIA	IROKO DOGATO	2

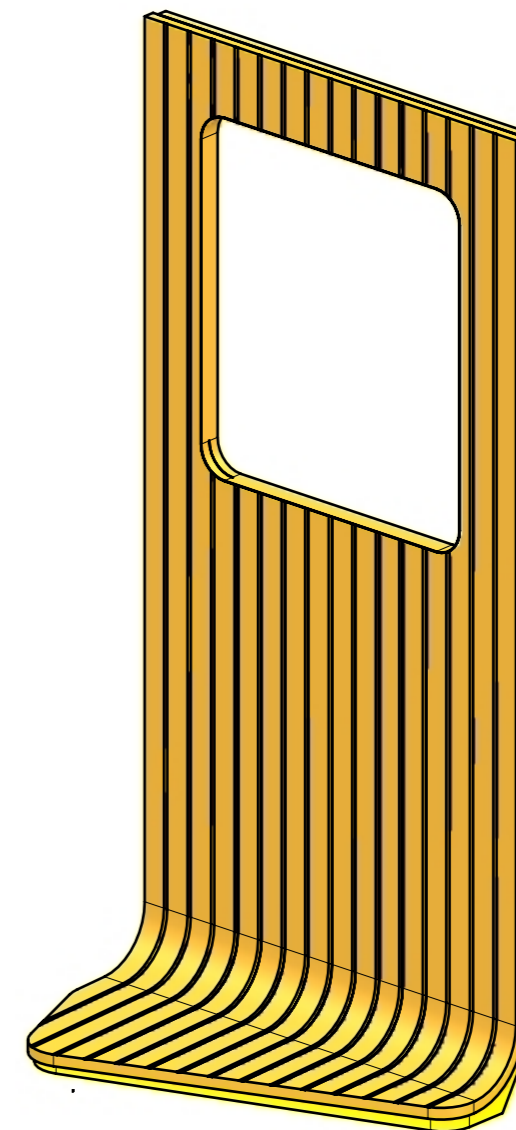
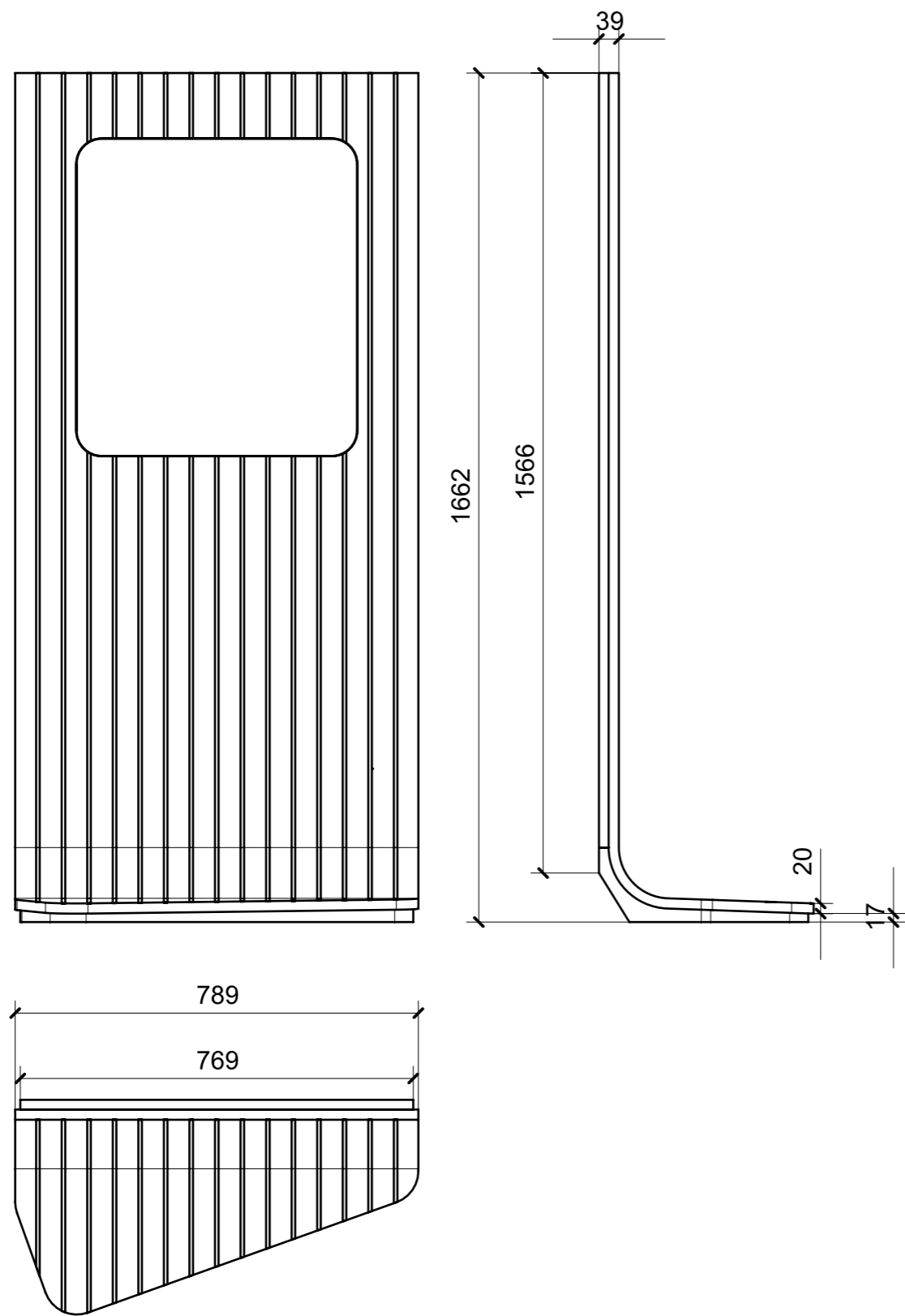

VERNICIATURA LASTRA/LACCATI:

● = VERNICIARE 1 LATO + FILI RASATI O BORDATI

NESSUN SIMBOLO = VERNICIARE 2 LATI + FILI RASATI O BORDATI

LOCALE	CODICE	DESCRIZIONE COMPONENTE	FINITURA	GR.
BAGNO ARMATORE	MD320_R01_WO01	CASSETTIERA MOBILE BAGNO	LASTRA SCURA	4

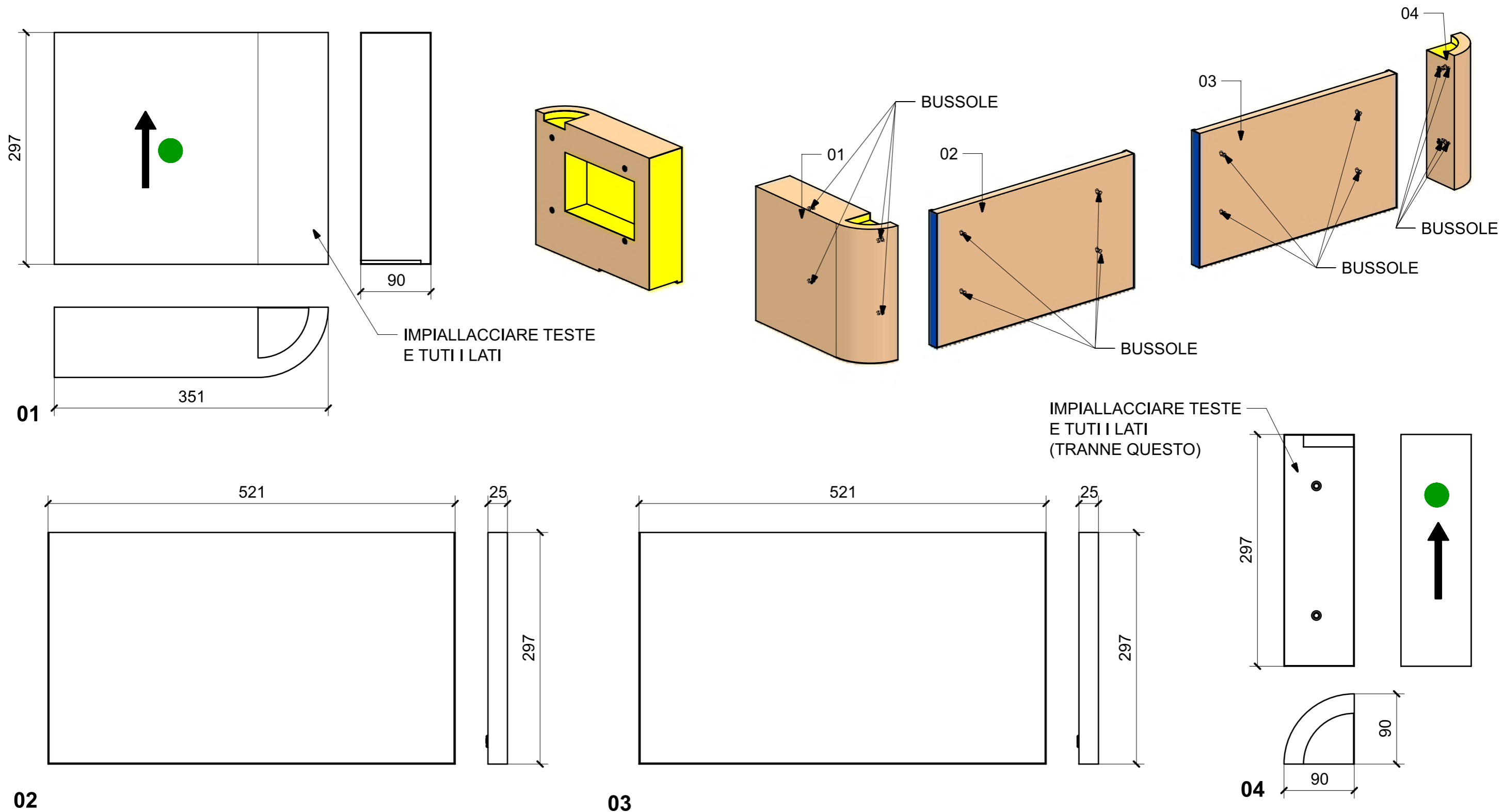

FERRAMENTA	QTY
PLACCHETTA COUNTER STEEL_TECHNOPARTNER_MC-JM49	2
BUSSOLA 6MA X 10 FORO DIAM.8	16

VERNICIATURA LASTRA/LACCATI:

● = VERNICIARE 1 LATO + FILI RASATI O BORDATI

NESSUN SIMBOLO = VERNICIARE 2 LATI + FILI RASATI O BORDATI

LOCALE	CODICE	DESCRIZIONE COMPONENTE	FINITURA	GR.
BAGNO ARMATORE	MD320_R01_WR01	ARMADIO PRUA FRONTE LAVELLO VAR.2-4	LASTRA SCURA	2

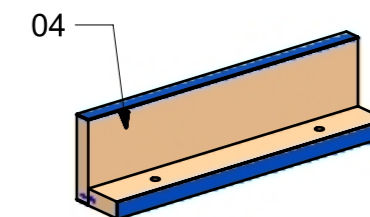
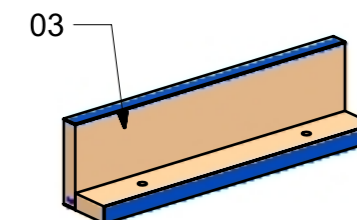
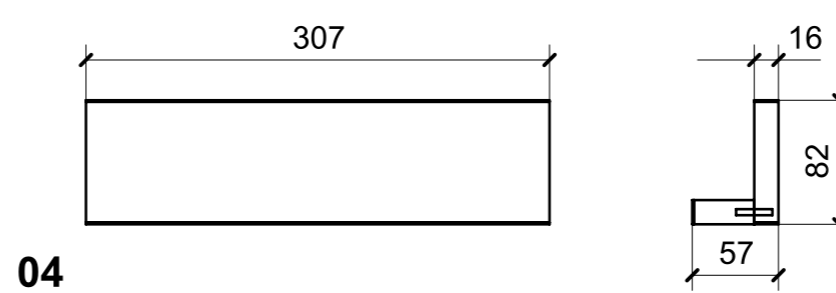
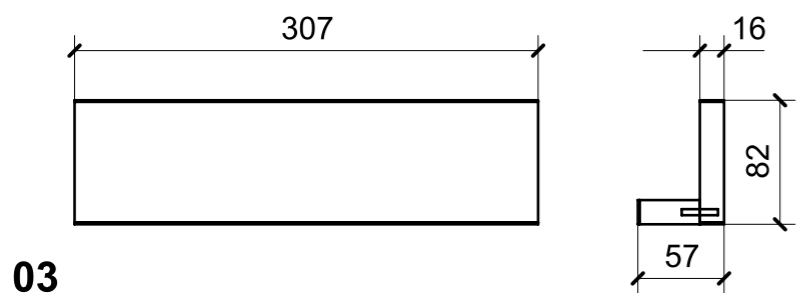
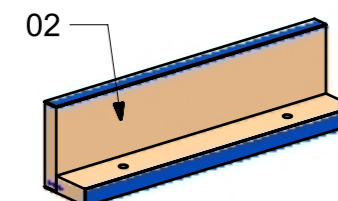
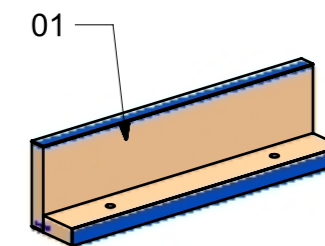
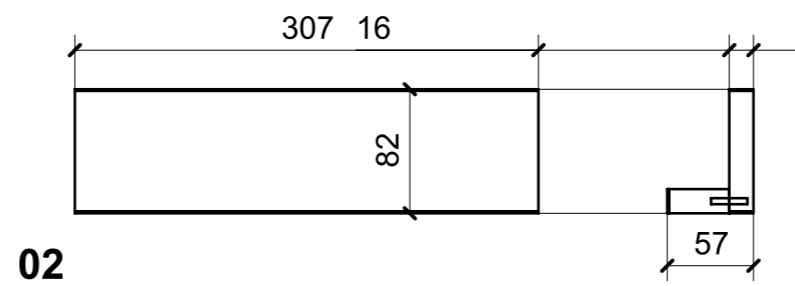
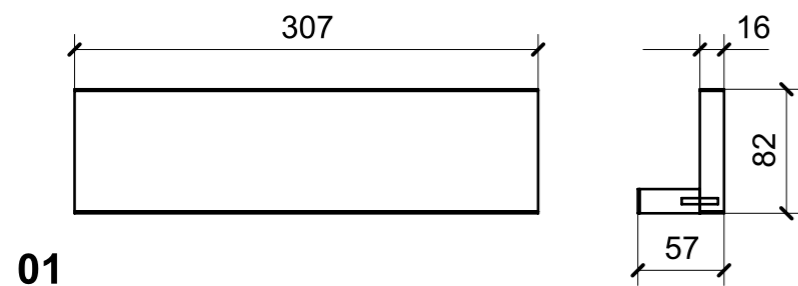

VERNICIATURA LASTRA/LACCATI:

● = VERNICIARE 1 LATO + FILI RASATI O BORDATI

NESSUN SIMBOLO = VERNICIARE 2 LATI + FILI RASATI O BORDATI

LOCALE	CODICE	DESCRIZIONE COMPONENTE	FINITURA	GR.
BAGNO ARMATORE	MD320_R01_WWR01	FACCIATA INGROSSO PARETE WC VAR.4	LAISTRA SCURA	4

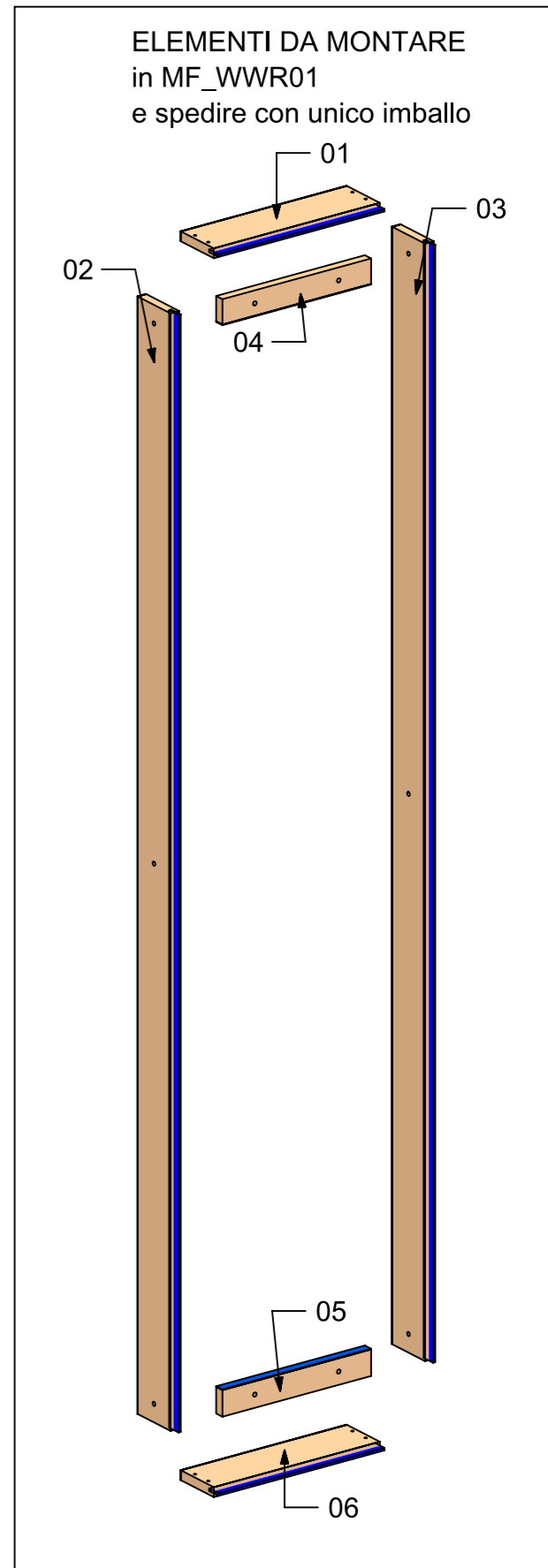
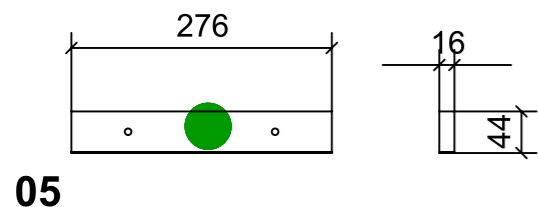
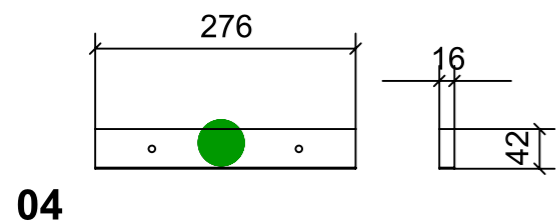
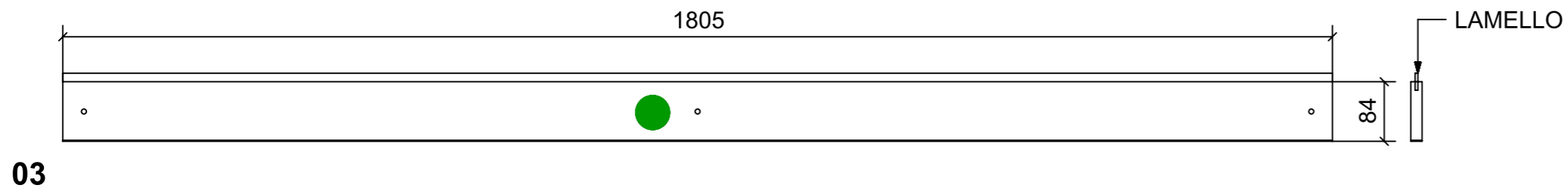
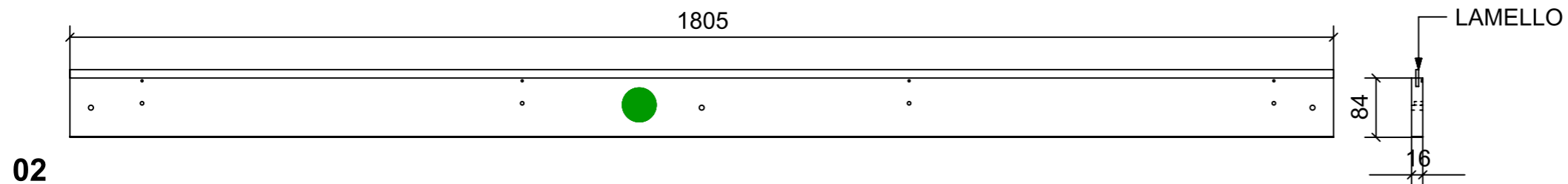
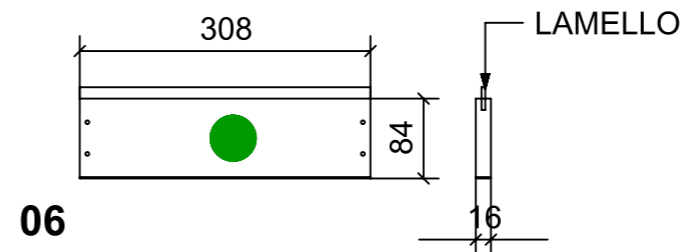
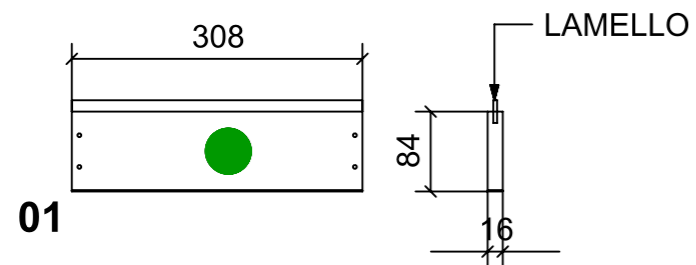

VERNICIATURA LASTRA/LACCATI:

● = VERNICIARE 1 LATO + FILI RASATI O BORDATI

NESSUN SIMBOLO = VERNICIARE 2 LATI + FILI RASATI O BORDATI

LOCALE	CODICE	DESCRIZIONE COMPONENTE	FINITURA	GR.
BAGNO ARMATORE	MD320_R02_WWR01	FACCIATA INGROSSO PARETE WC VAR.4	LASTRA CHIARA	4

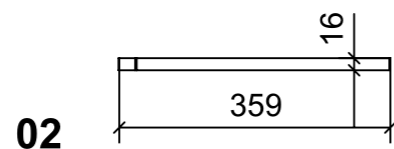
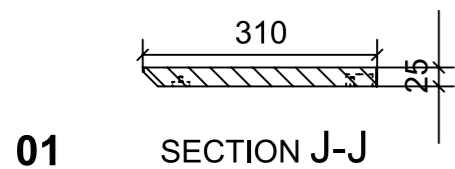
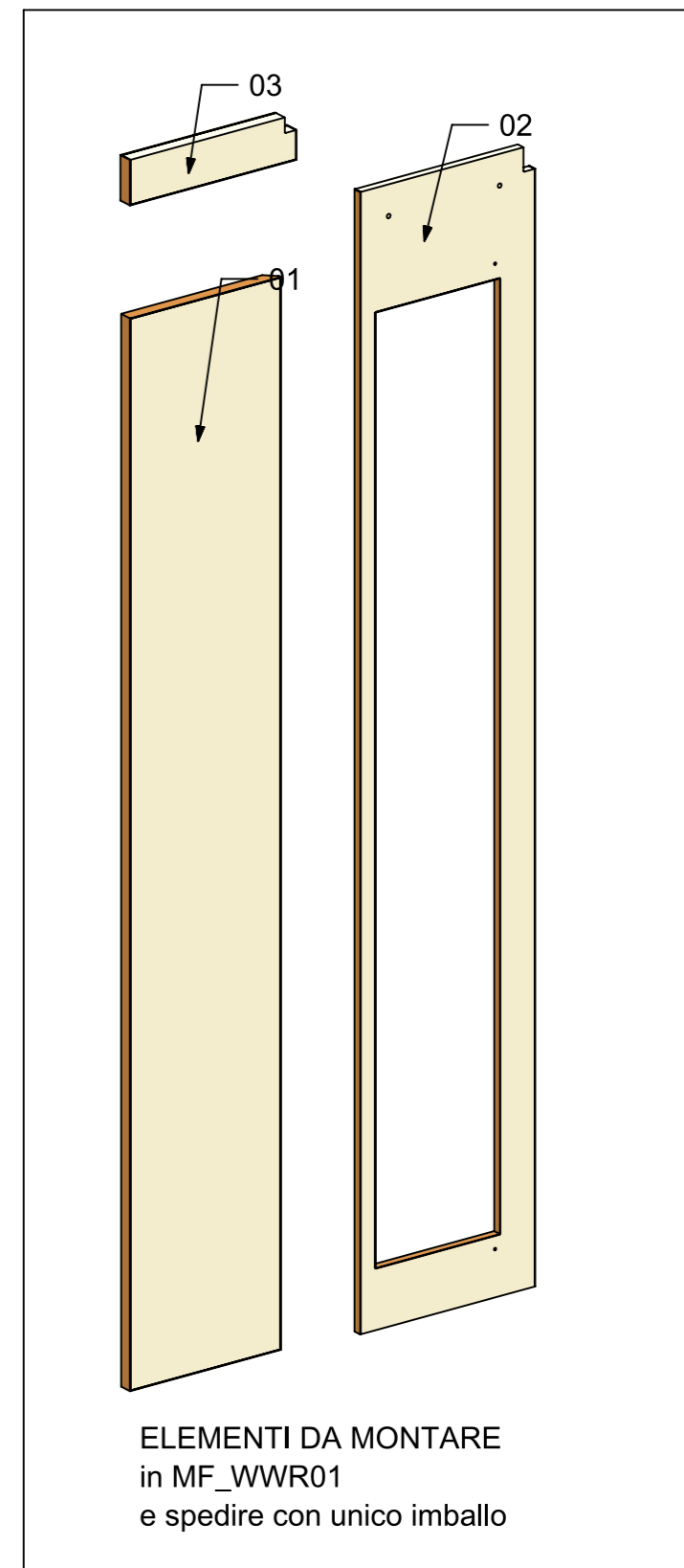
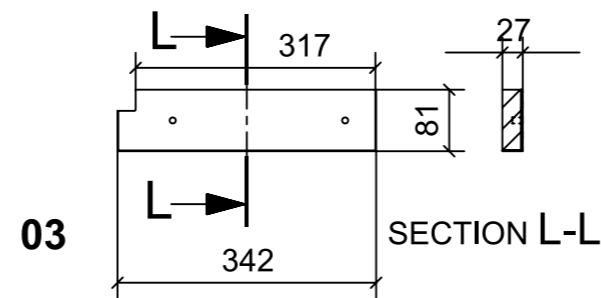
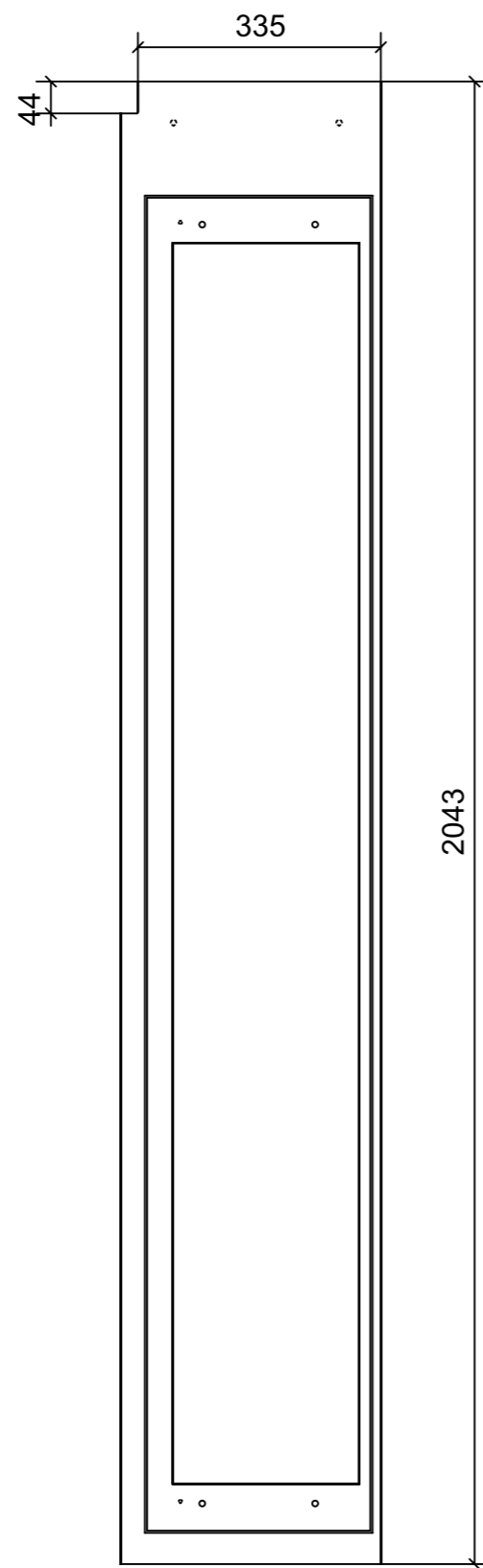
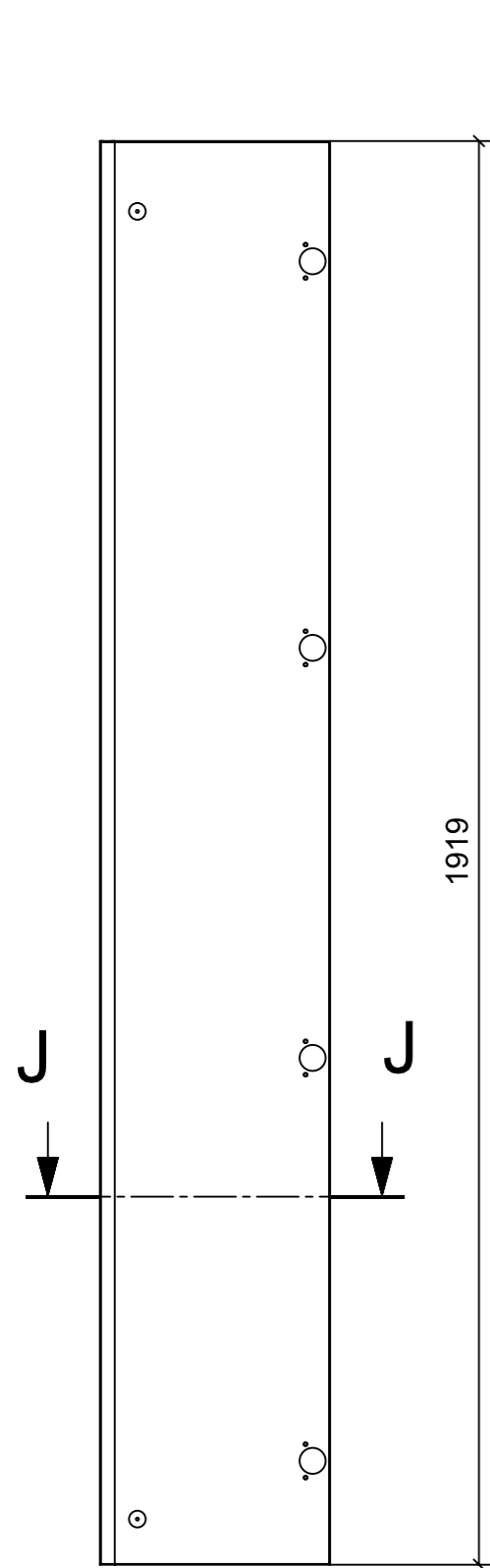

VERNICIATURA LASTRA/LACCATI:

● = VERNICIARE 1 LATO + FILI RASATI O BORDATI

NESSUN SIMBOLO = VERNICIARE 2 LATI + FILI RASATI O BORDATI

LOCALE	CODICE	DESCRIZIONE COMPONENTE	FINITURA	GR.
BAGNO ARMATORE	MD320_R02_WT01	MURETTO DIVISORIO INGRESSO BAGNO VAR.3-4	LASTRA CHIARA	2

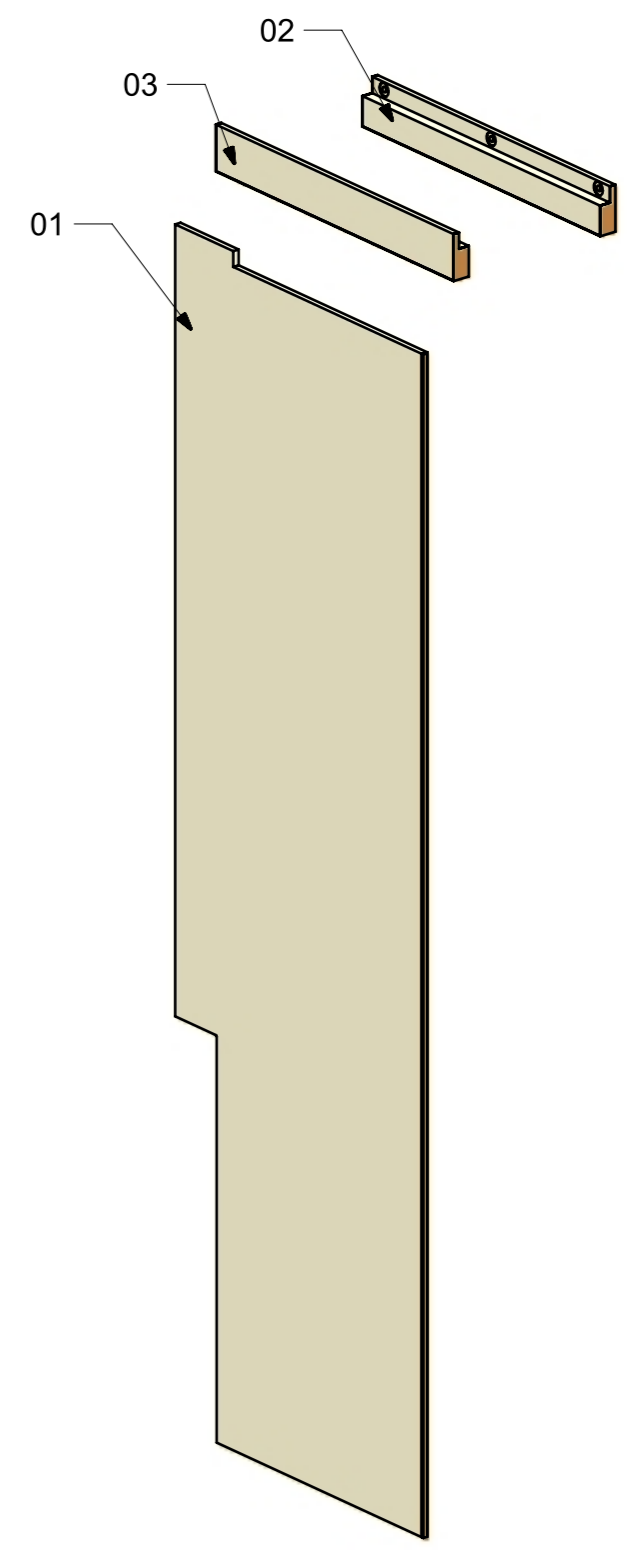
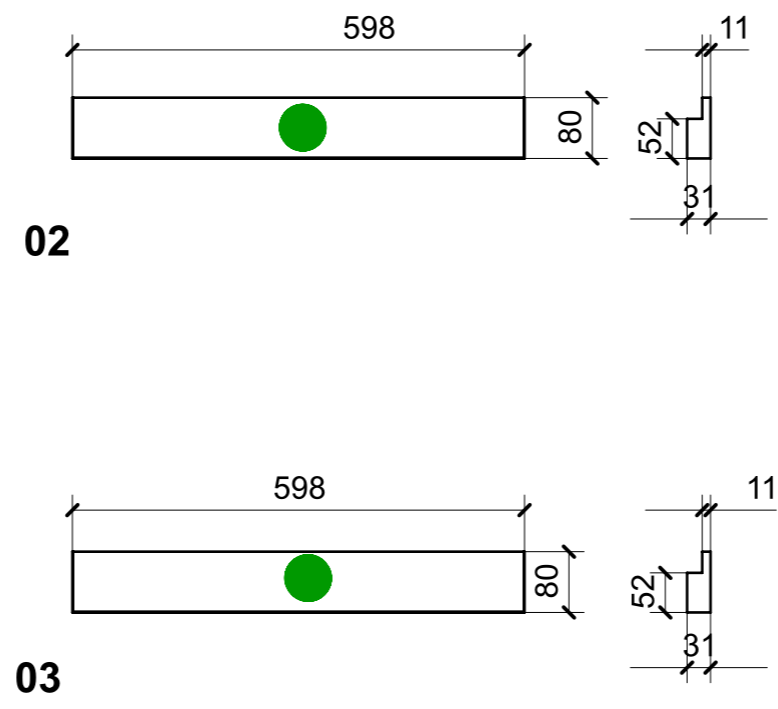
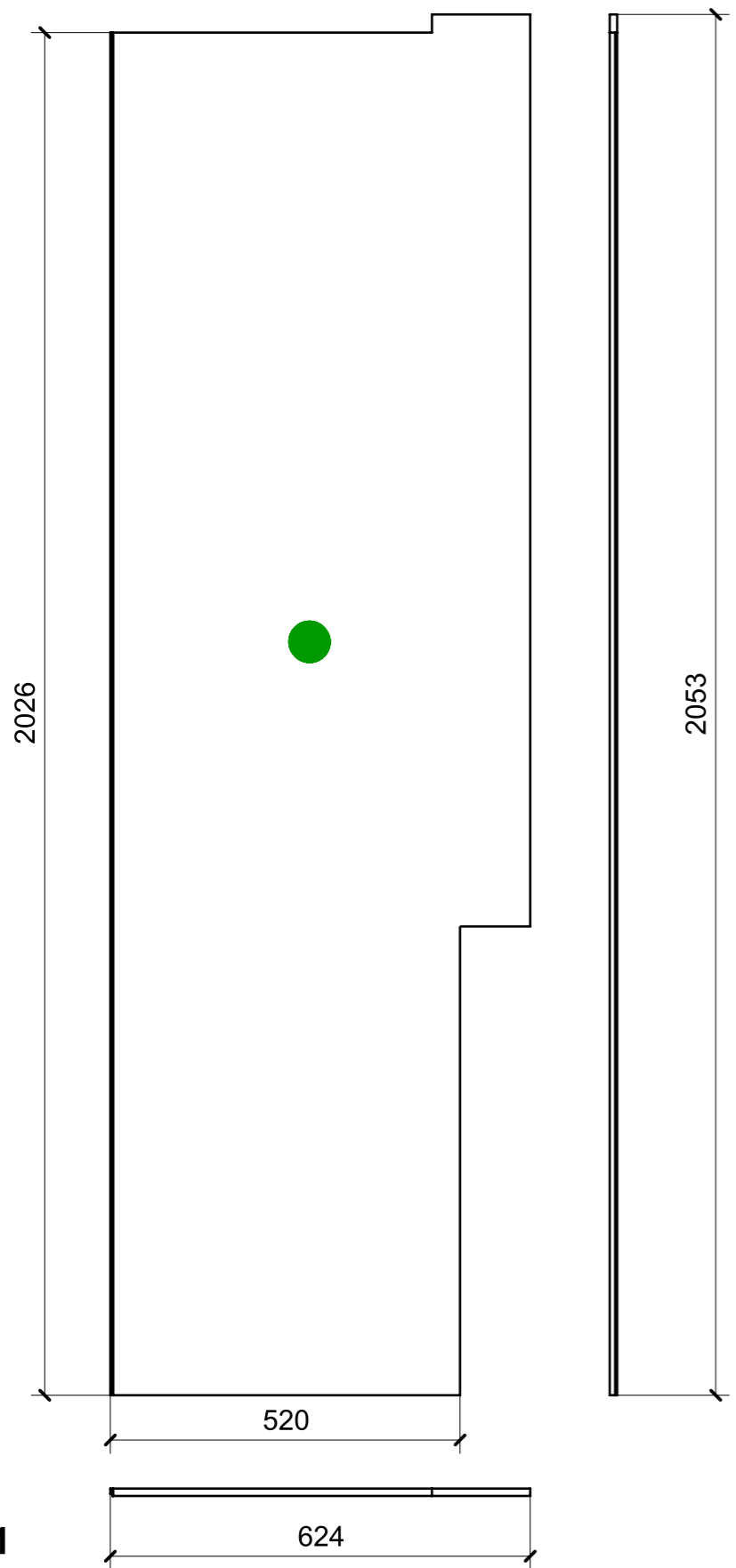

FERRAMENTA	QTY
MS INCASSO_ITALVIPLA_972_FMPC_M1B	7

01

VERNICIATURA LASTRA/LACCATI:
 ● = VERNICIARE 1 LATO + FILI RASATI O BORDATI NESSUN SIMBOLO = VERNICIARE 2 LATI + FILI RASATI O BORDATI

LOCALE	CODICE	DESCRIZIONE COMPONENTE	FINITURA	GR.
BAGNO ARMATORE	MD320_R03_WU01	PAVIMENTO BAGNO SENZA BIDET VAR.2-4	IROKO	PTP

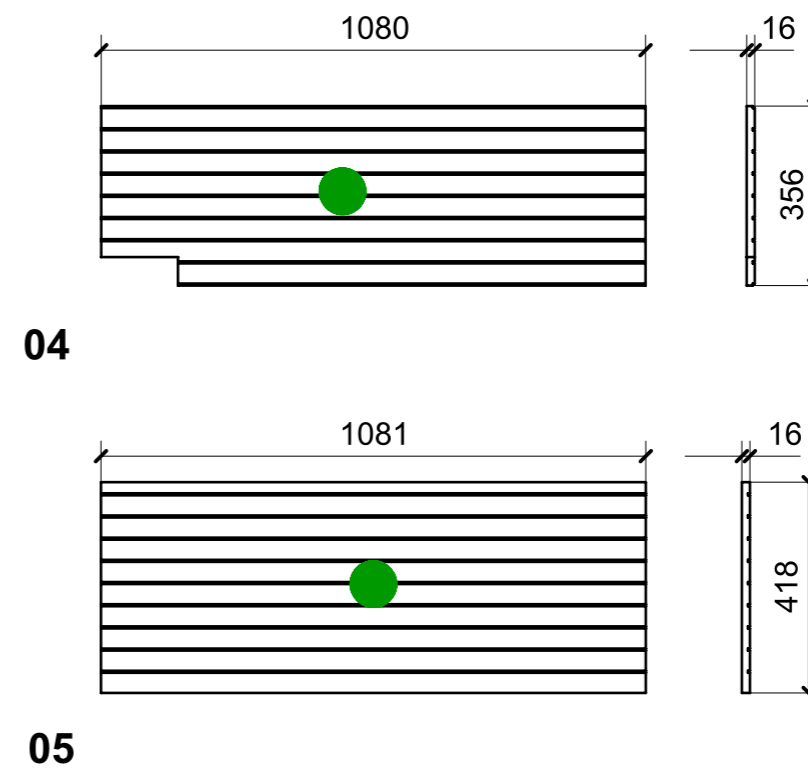
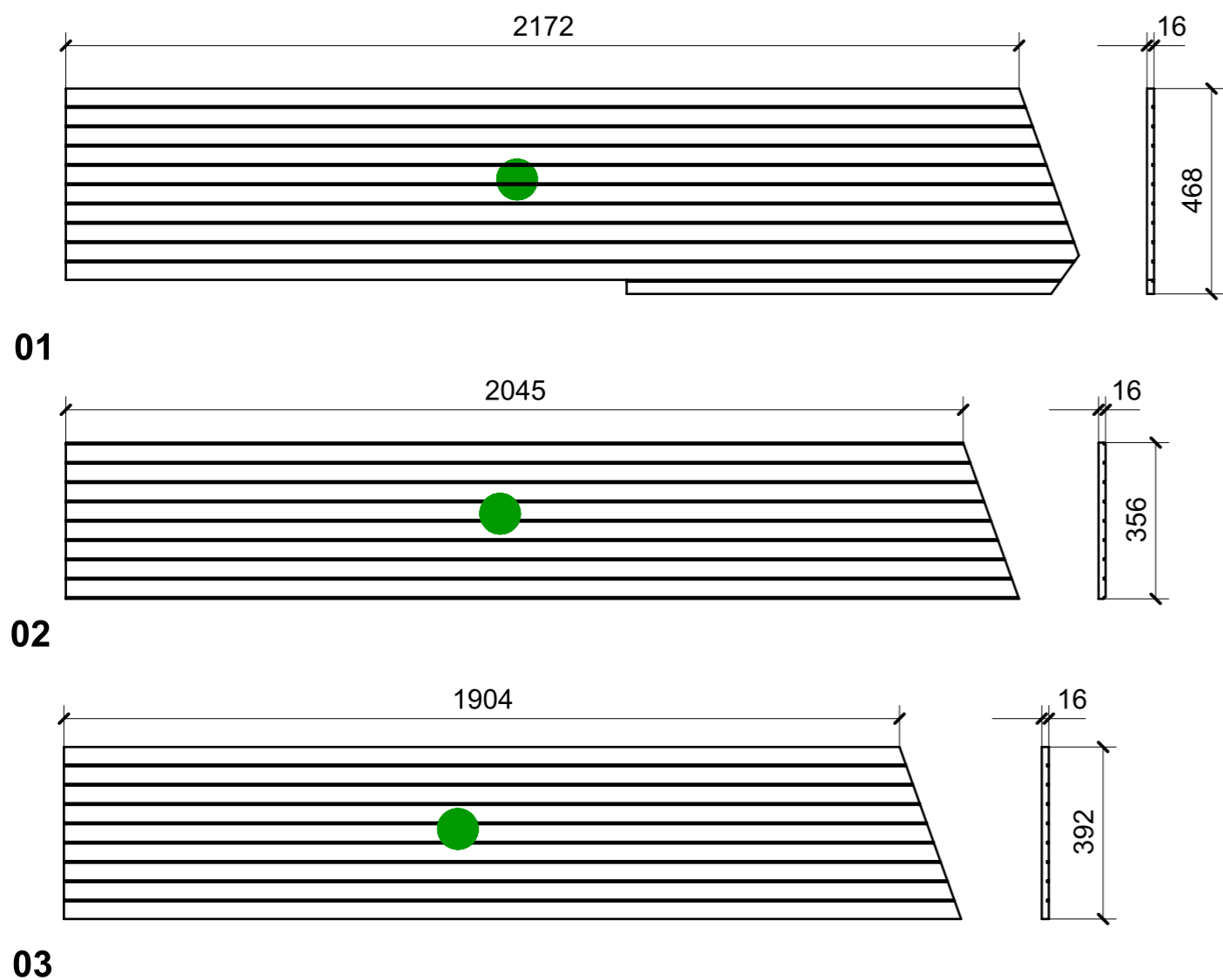
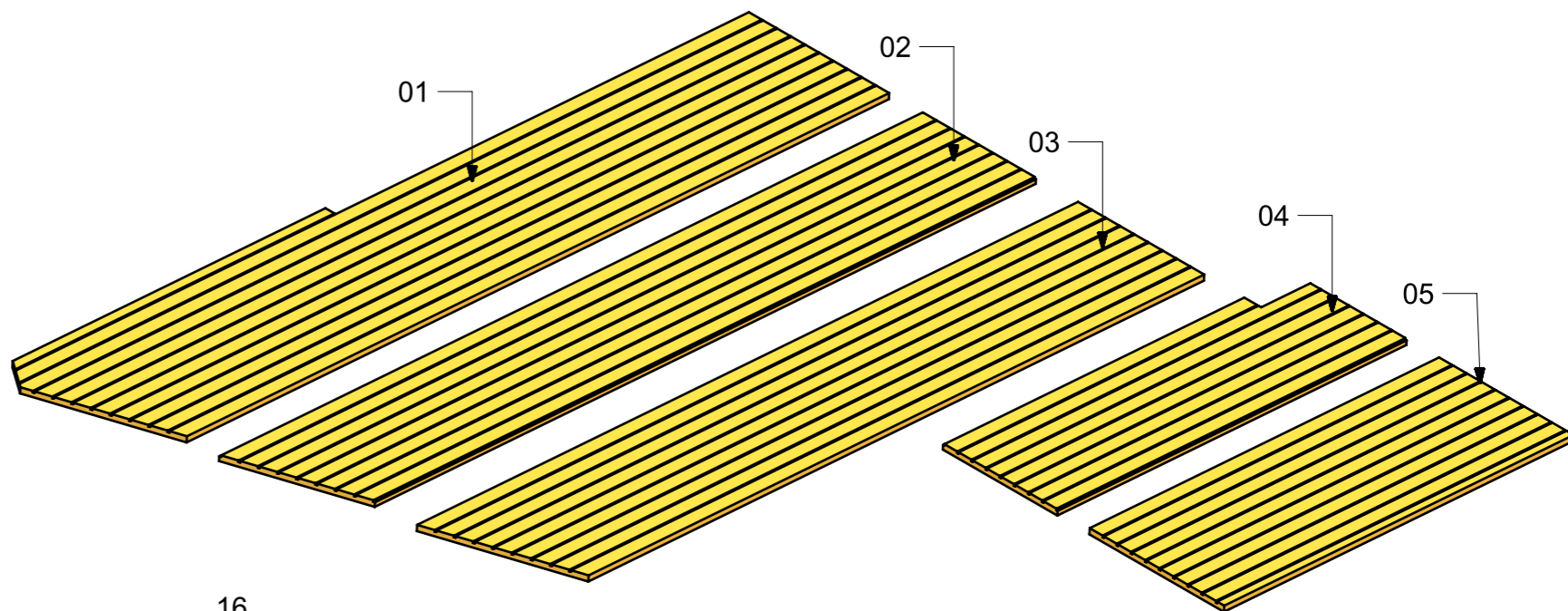

VERNICIATURA LASTRA/LACCATI:

● = FILI RASATI

● = VERNICIARE 1 LATO + FILI RASATI O BORDATI

NESSUN SIMBOLO = VERNICIARE 2 LATI + FILI RASATI O BORDATI

LOCALE	CODICE	DESCRIZIONE COMPONENTE	FINITURA	GR.
BAGNO ARMATORE	MD320_R03_WWU01	PAVIMENTO BAGNO CON BIDET VAR.1-3	IROKO	PTP

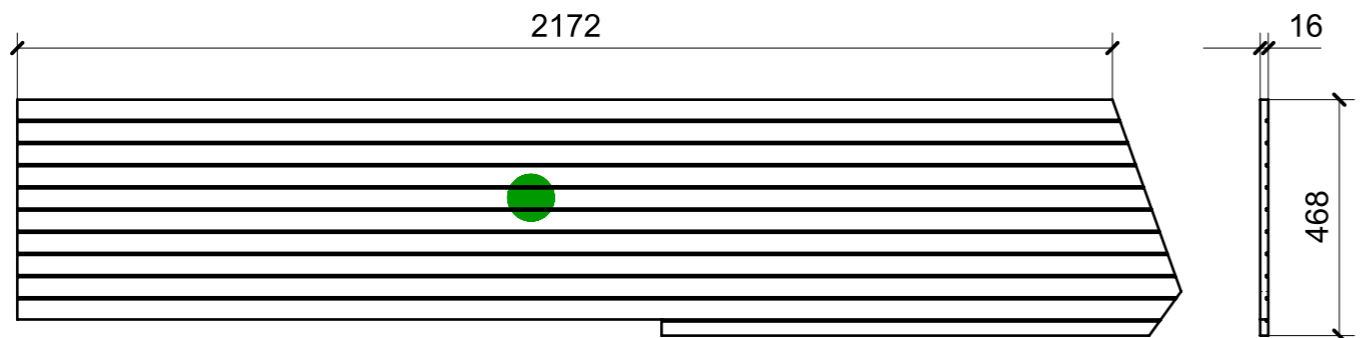
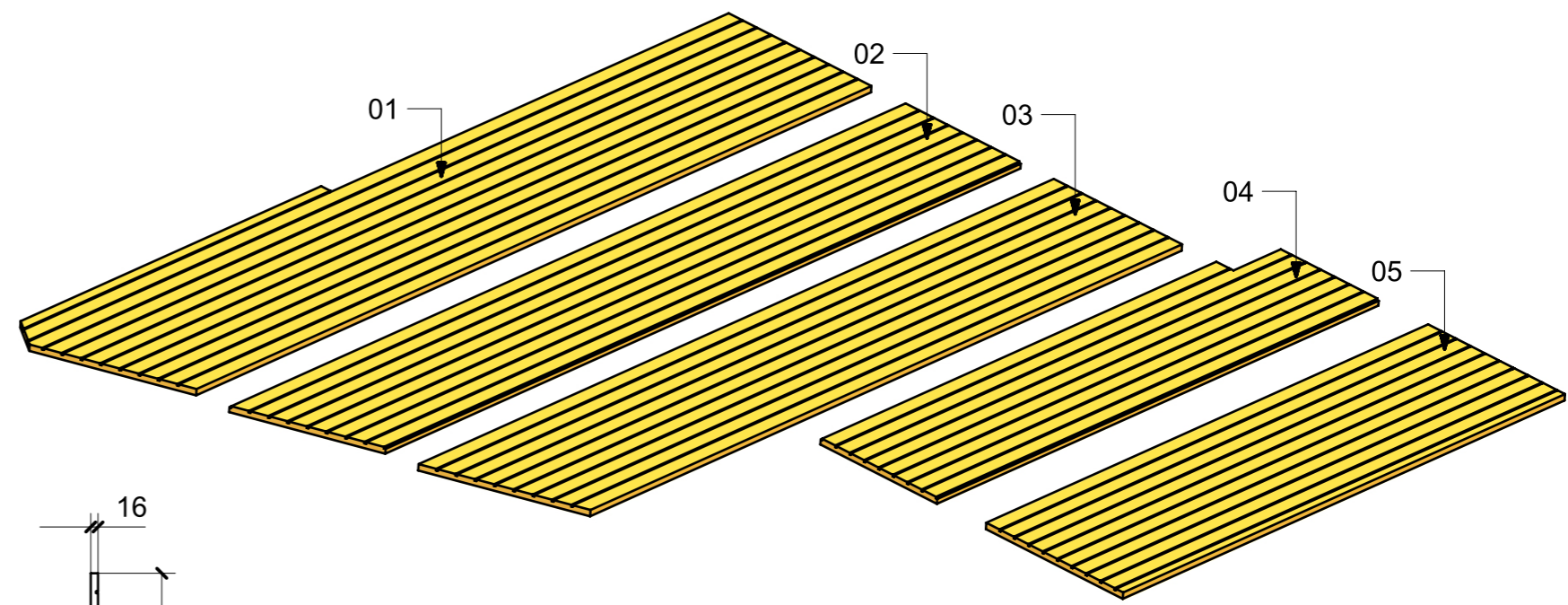

01

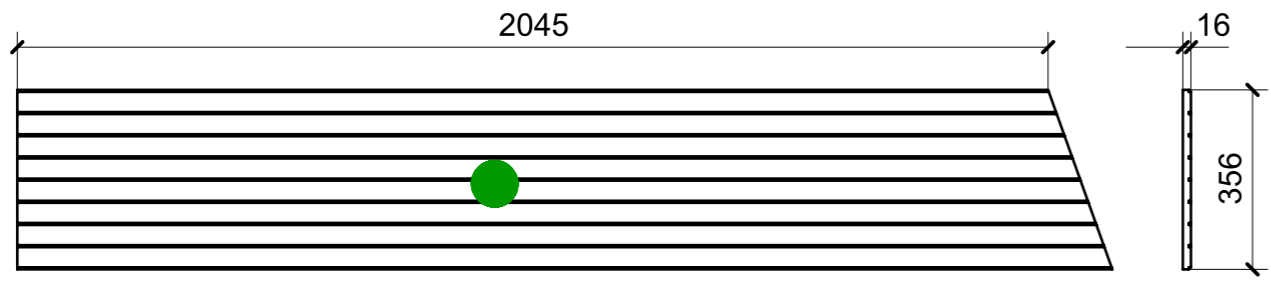

02

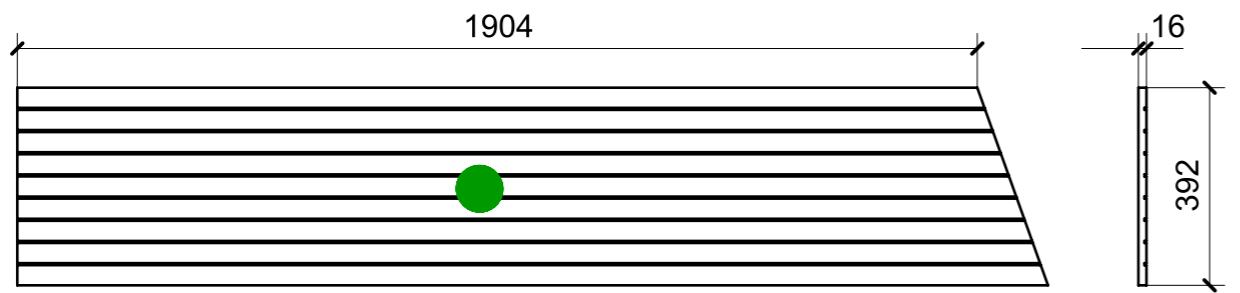

03

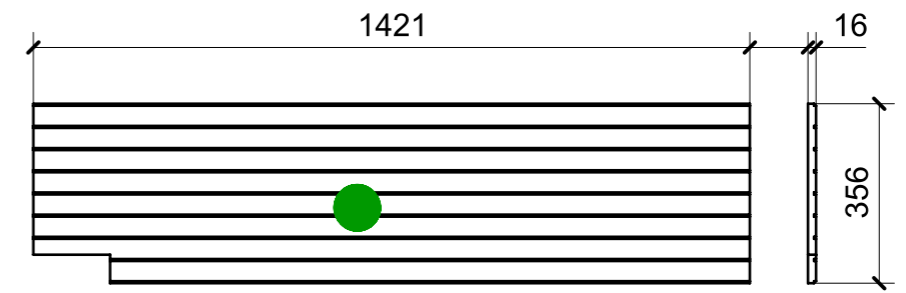

04

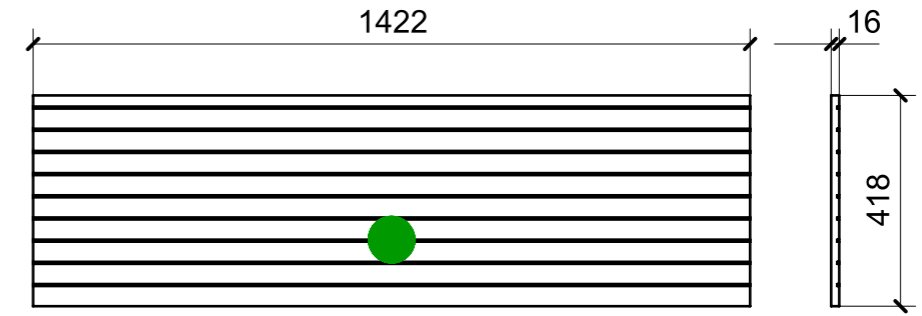

05

VERNICIATURA LASTRA/LACCATI:
 ● = FILI RASATI ● = VERNICIARE 1 LATO + FILI RASATI O BORDATI NESSUN SIMBOLO = VERNICIARE 2 LATI + FILI RASATI O BORDATI

LOCALE	CODICE	DESCRIZIONE COMPONENTE	FINITURA	GR.
BAGNO ARMATORE	MD320_R03_WZ01	CARABOTTINO DOCCIA	IROKO	PTP

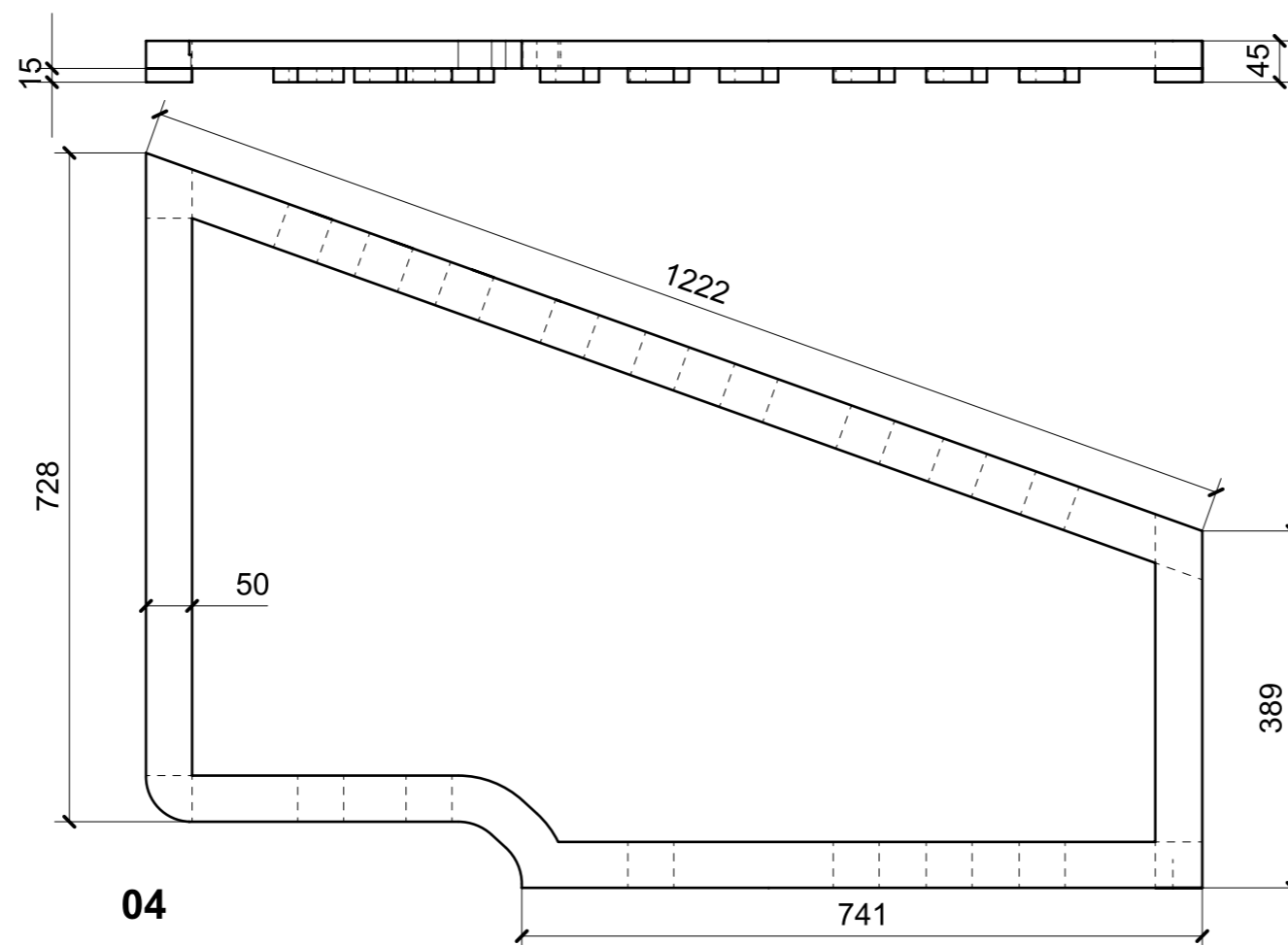
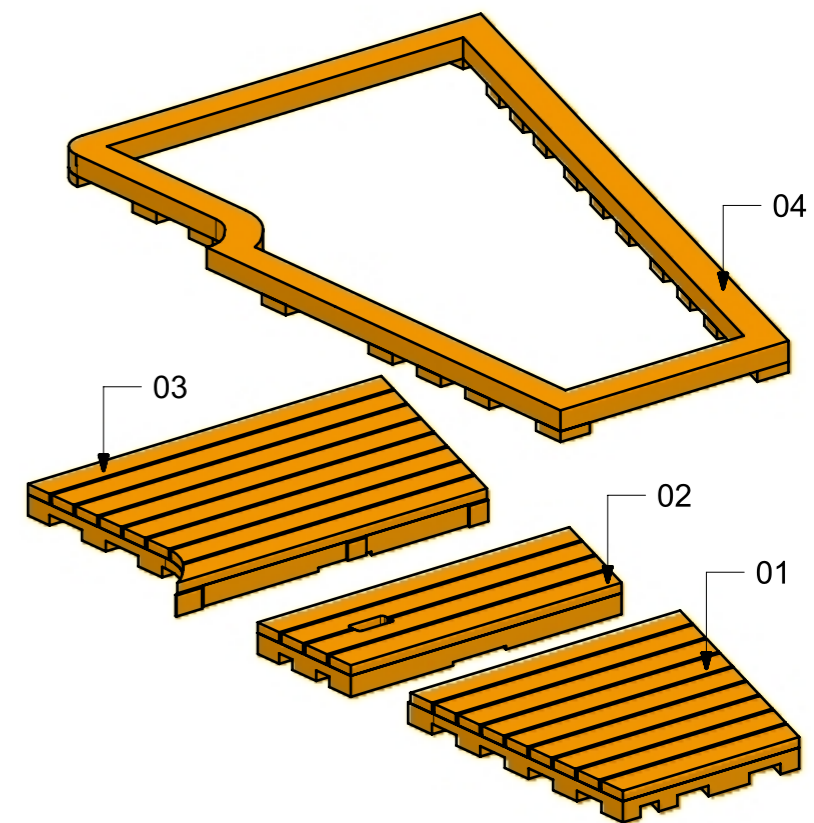
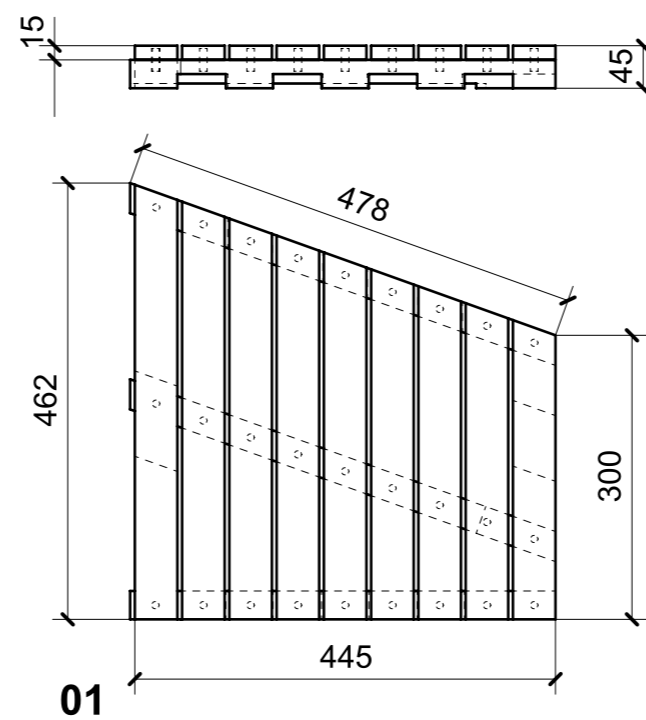
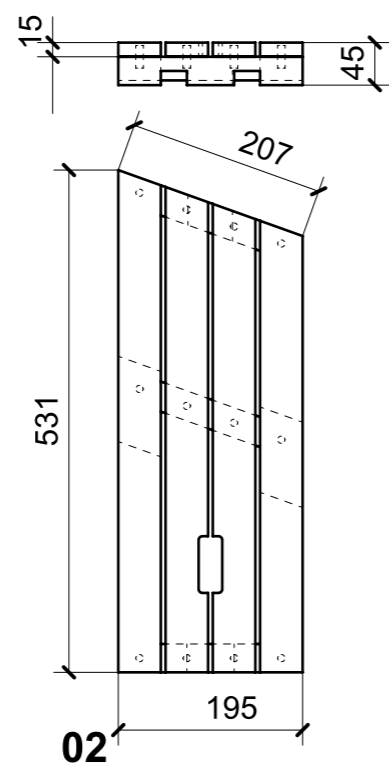
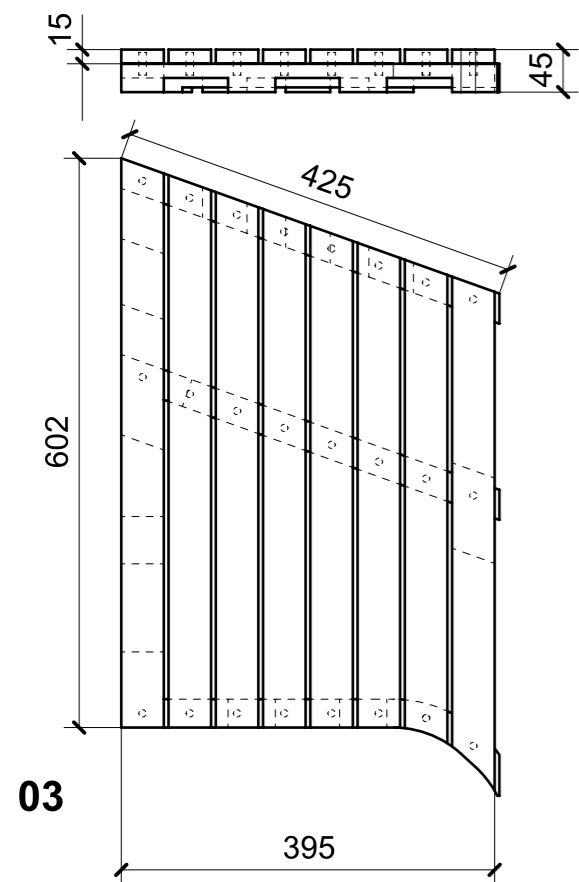

VERNICIATURA LASTRA/LACCATI:

● = VERNICIARE 1 LATO + FILI RASATI O BORDATI

NESSUN SIMBOLO = VERNICIARE 2 LATI + FILI RASATI O BORDATI