

LOCALE	CODICE	DESCRIZIONE COMPONENTE	FINITURA	GR.
CUCINA	MD320_X01_KE01	RIV. MARMO POPPA	BETACRIL	3

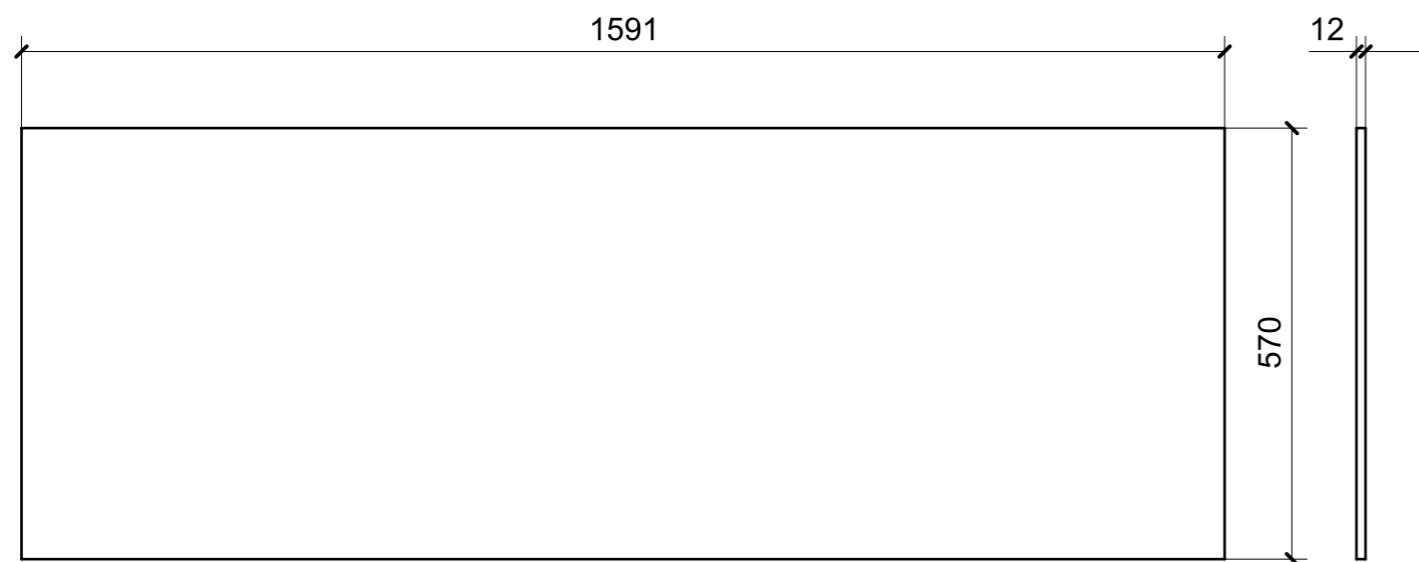

02

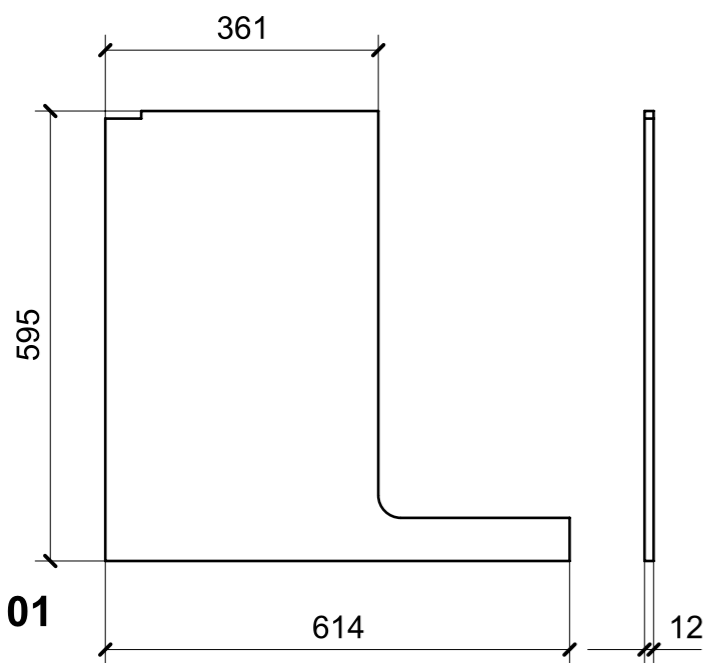
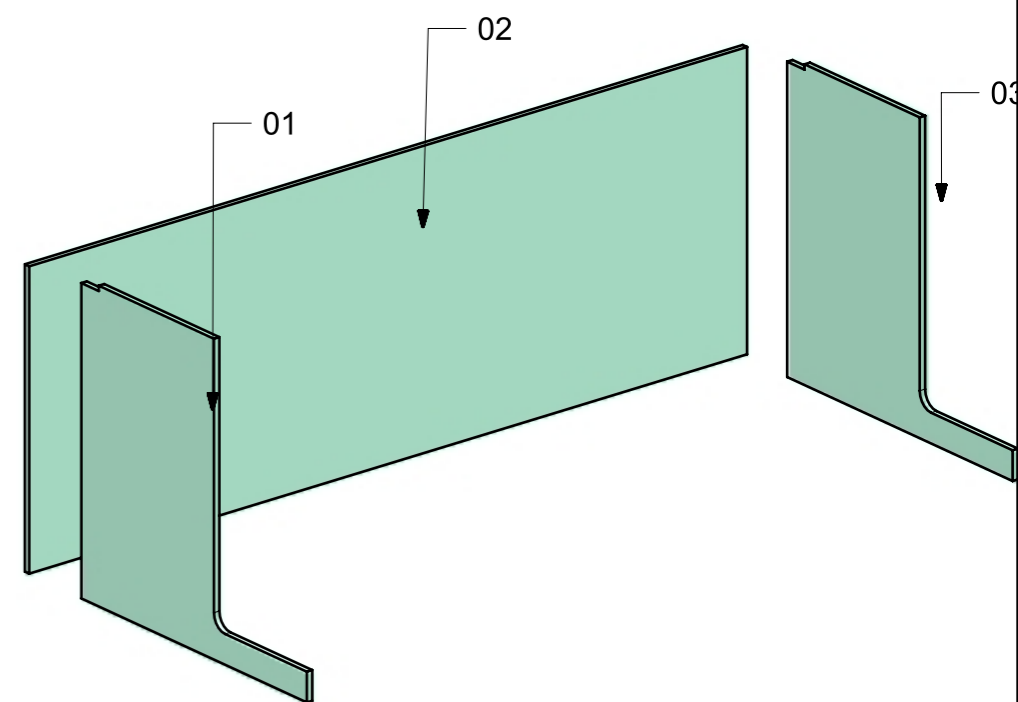

01

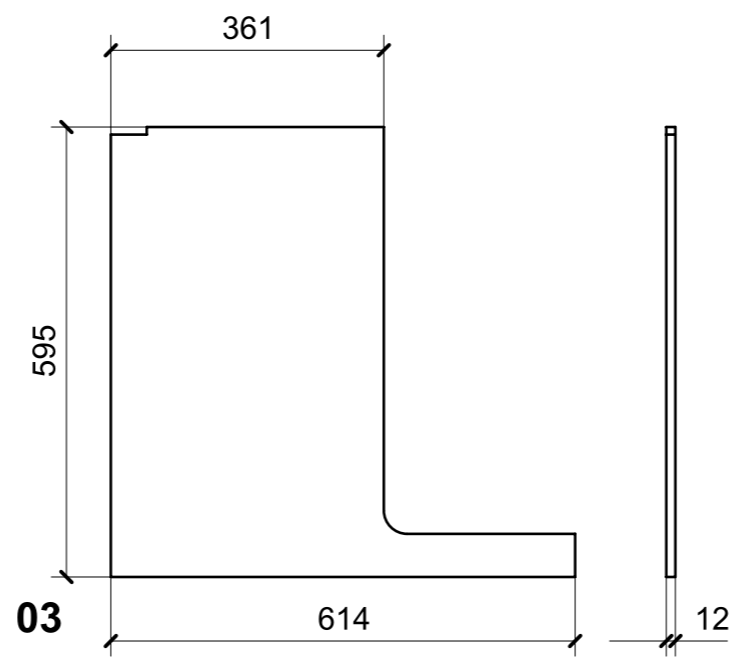

03

LOCALE	CODICE	DESCRIZIONE COMPONENTE	FINITURA	GR.
CUCINA	MD320_X01_KF01	BASE CUCINA PRUA	BETACRIL	4

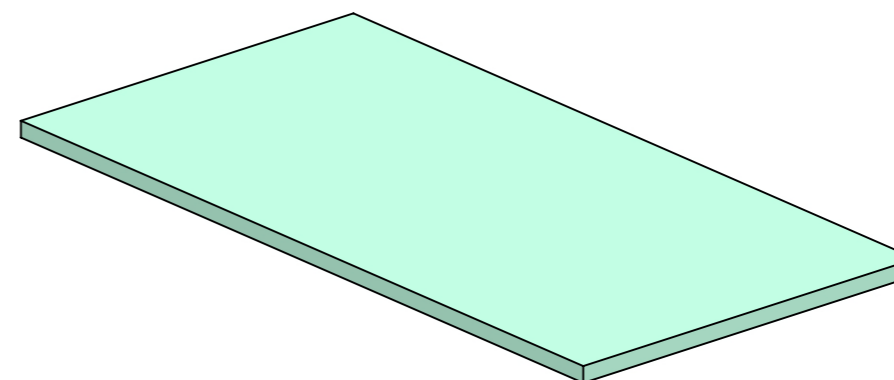
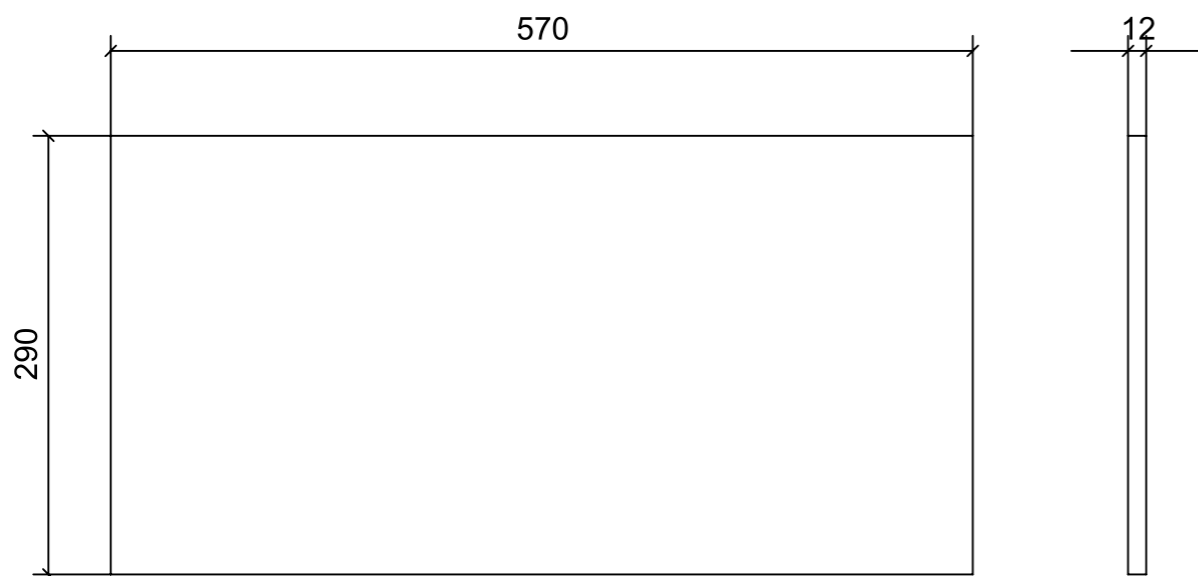

LOCALE	CODICE	DESCRIZIONE COMPONENTE	FINITURA	GR.
CUCINA	MD320_X01_KI01	RIV. MARMO PRUA	BETACRIL	3

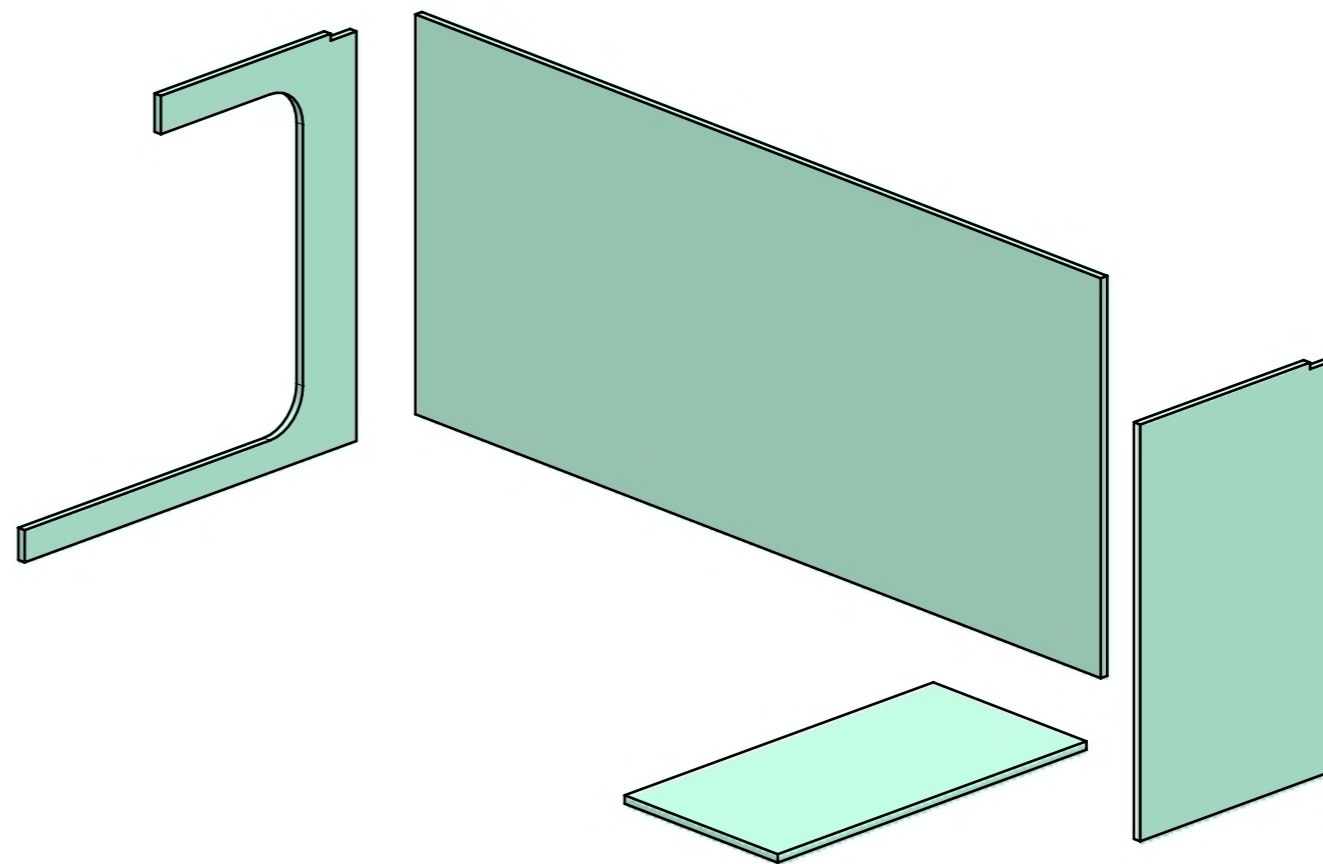
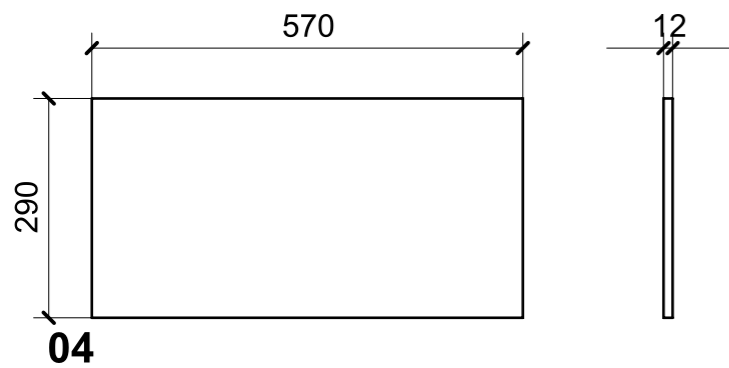
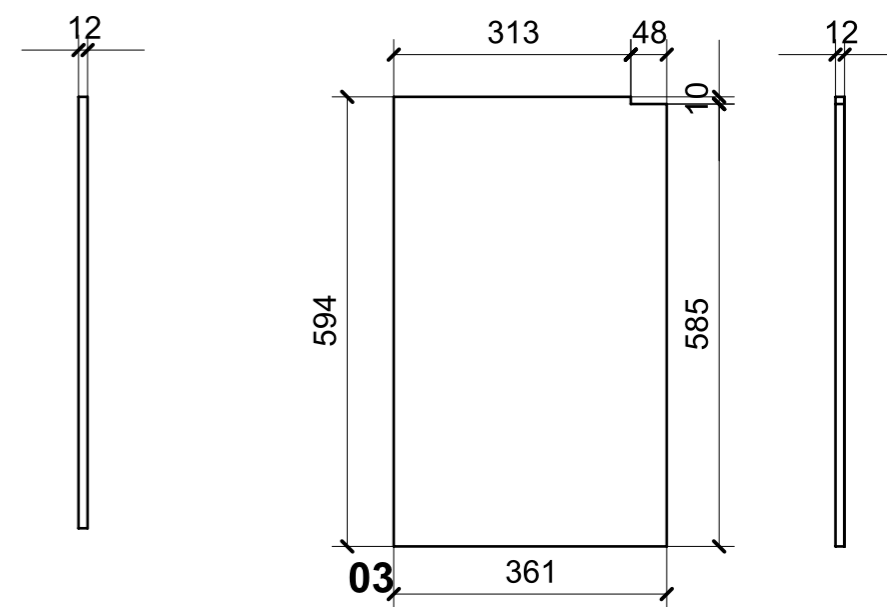
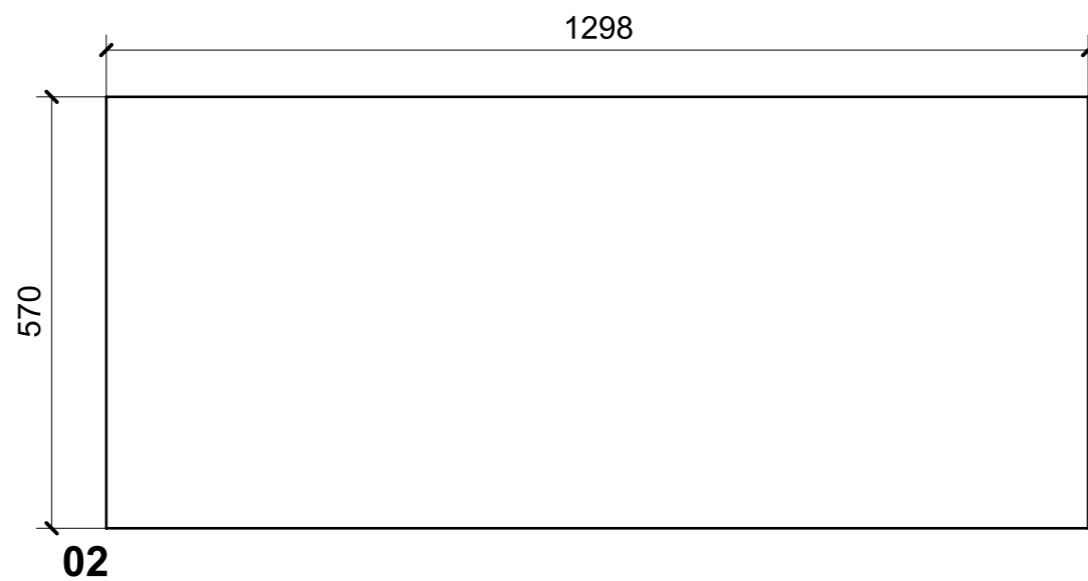
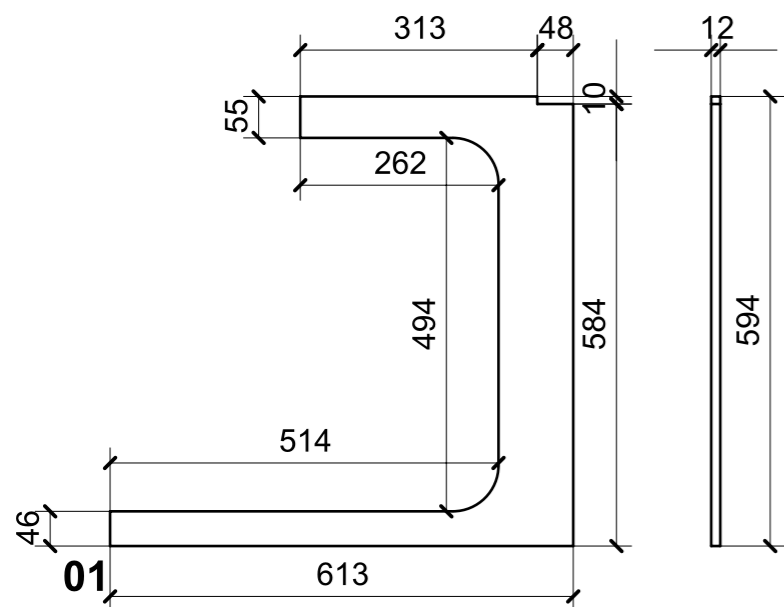

LOCALE	CODICE	DESCRIZIONE COMPONENTE	FINITURA	GR.
CUCINA	MD320_X01_KO01	CASSA FRIGO AGGIUNTIVO	LAMINATO NERO OPACO	4

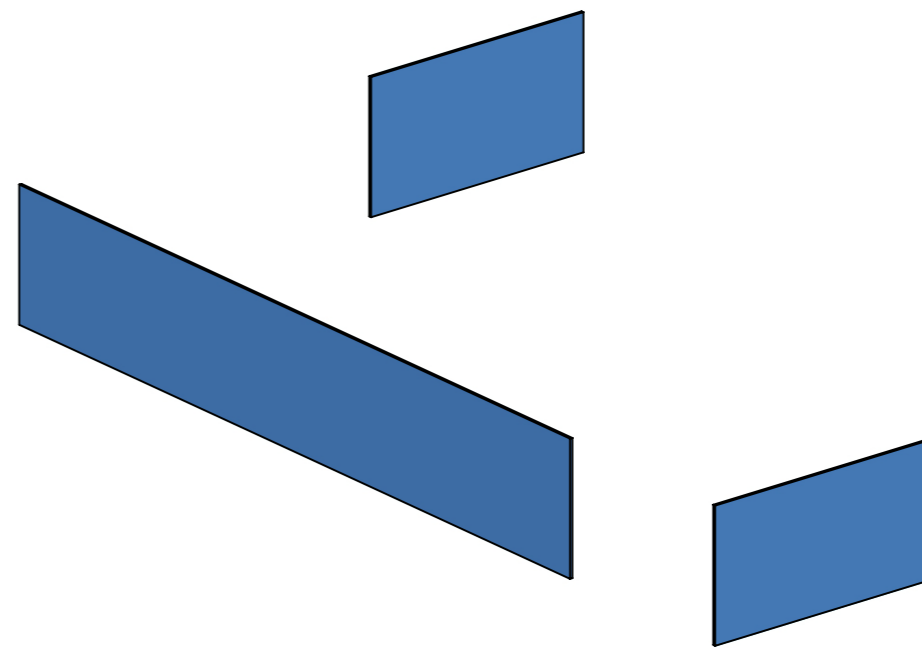
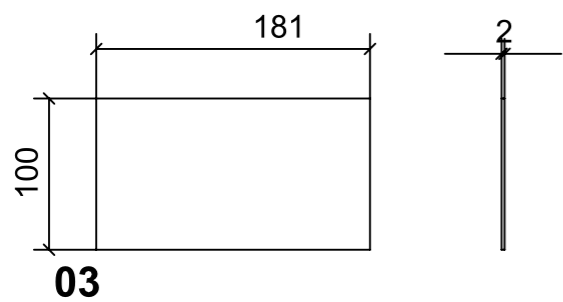
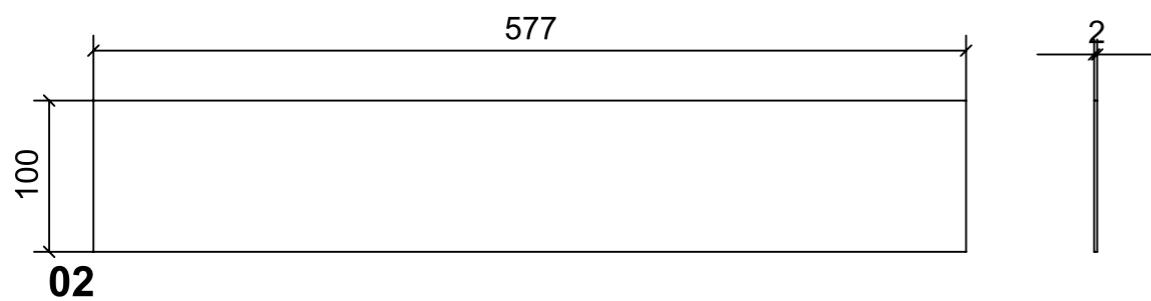
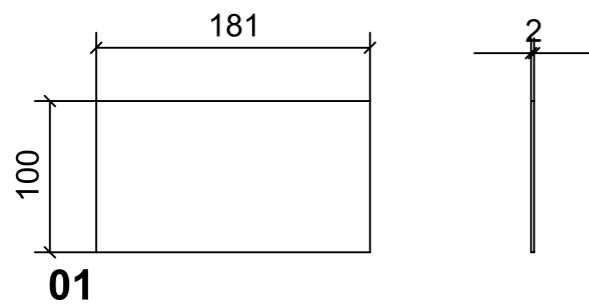

LOCALE	CODICE	DESCRIZIONE COMPONENTE	FINITURA	GR.
CUCINA	MD320_X01_KQ01	TOP BASE CUCINA PRUA 90_Var 2	BETACRIL	3

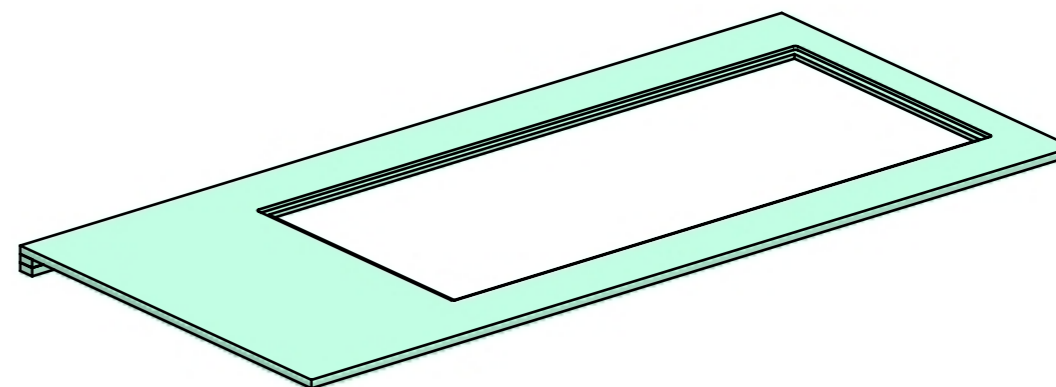
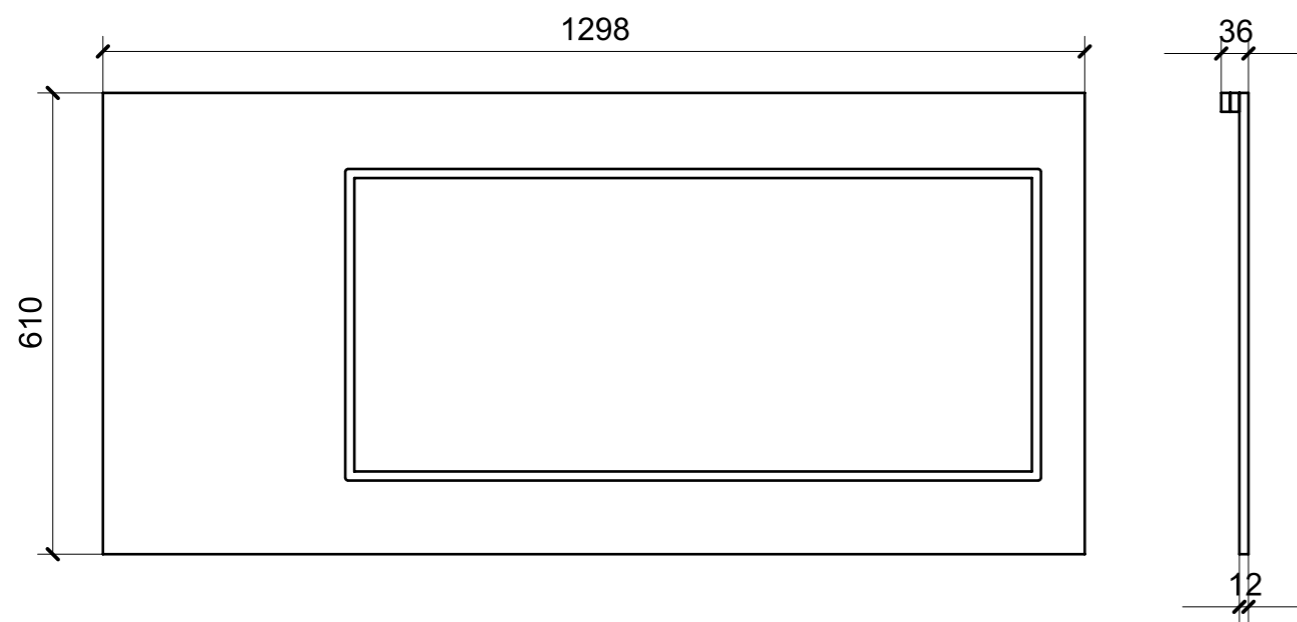

LOCALE	CODICE	DESCRIZIONE COMPONENTE	FINITURA	GR.
CUCINA	MD320_X01_KKQ01	TOP BASE CUCINA PRUA 60_Var 1	BETACRIL	3

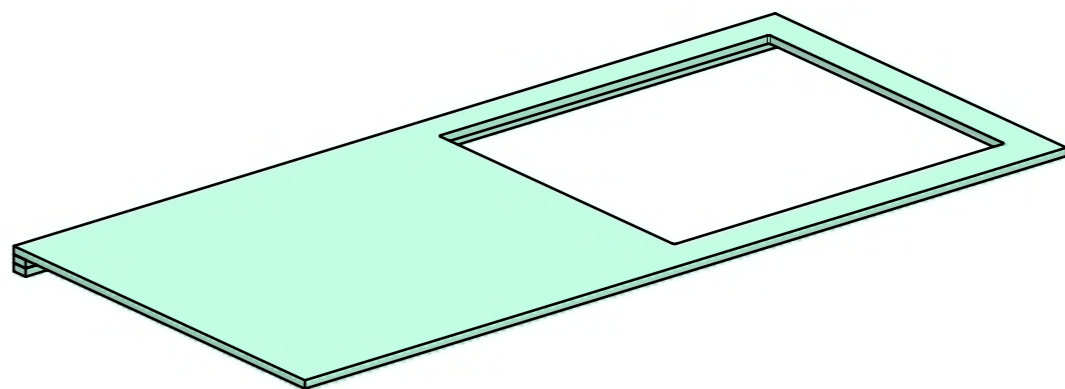
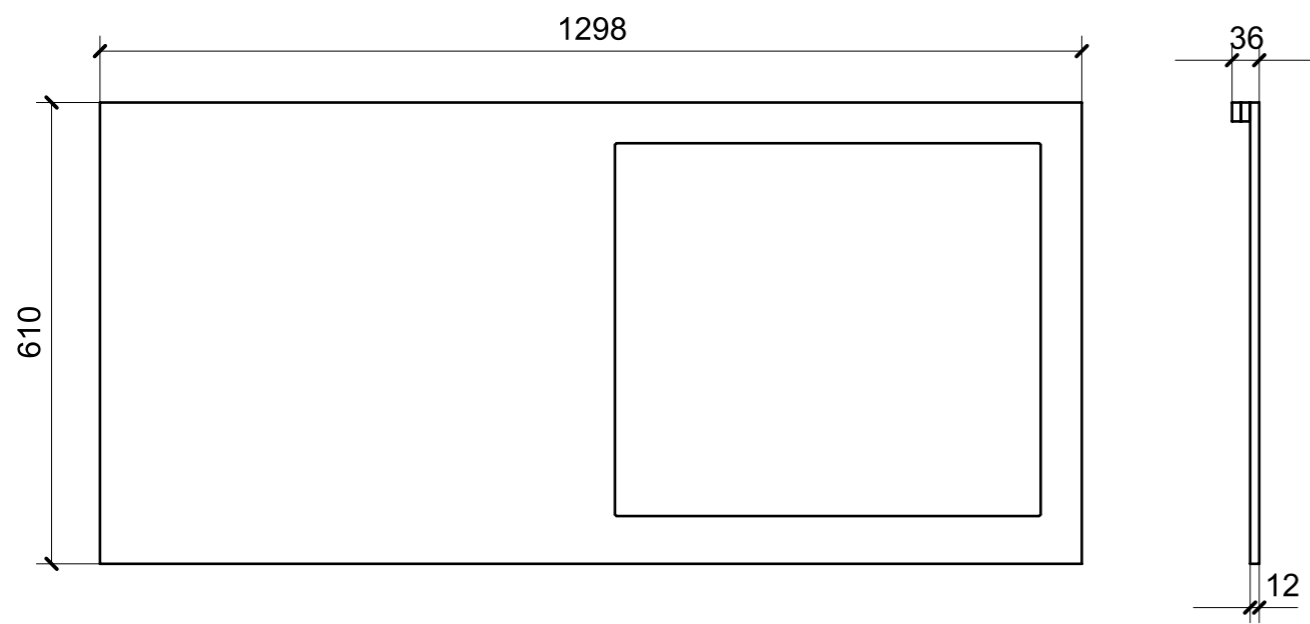

LOCALE	CODICE	DESCRIZIONE COMPONENTE	FINITURA	GR.
CUCINA	MD320_X01_KR01	TOP BASE CUCINA POPPA	BETACRIL	3

