

LOCALE	CODICE	DESCRIZIONE COMPONENTE	FINITURA	GR.
BAGNO VIP DX	MD320_I01_JI01	MOBILE SOTTO LAVELLO	OKOUME' GREZZO	4

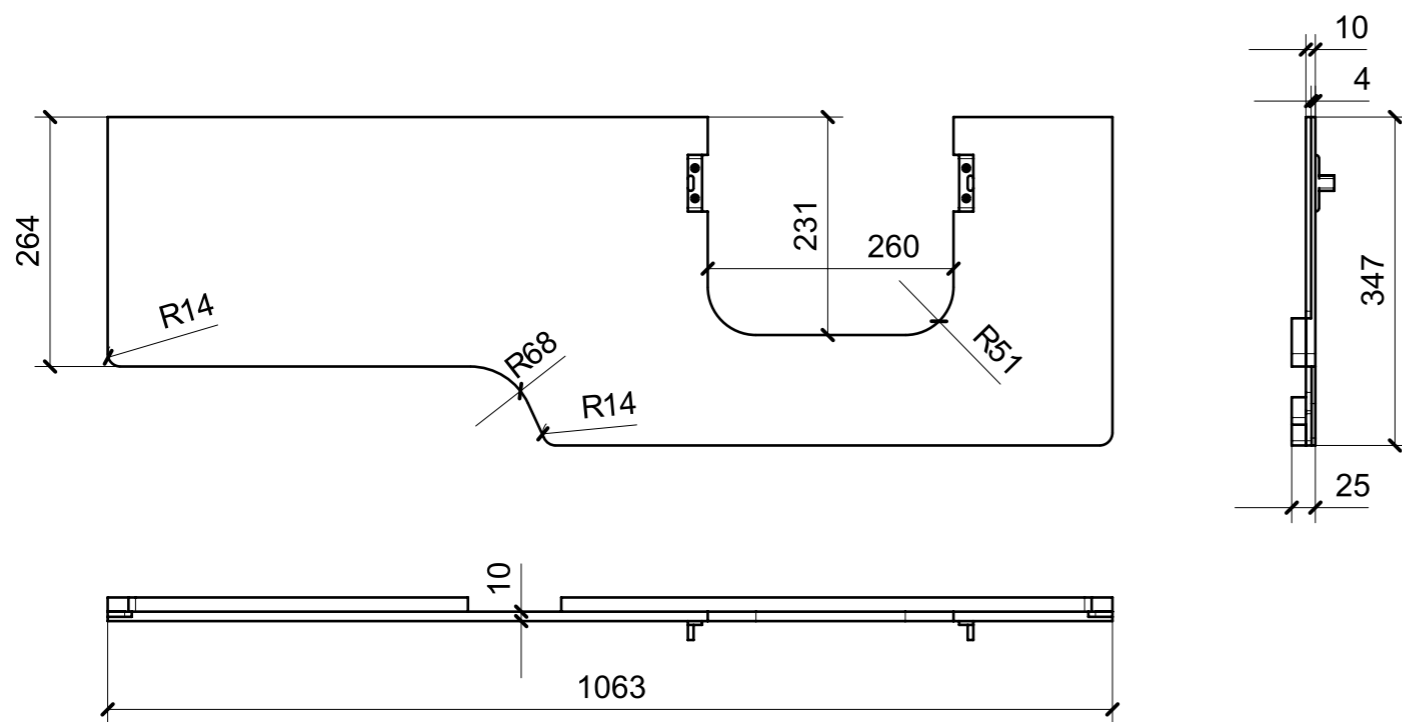
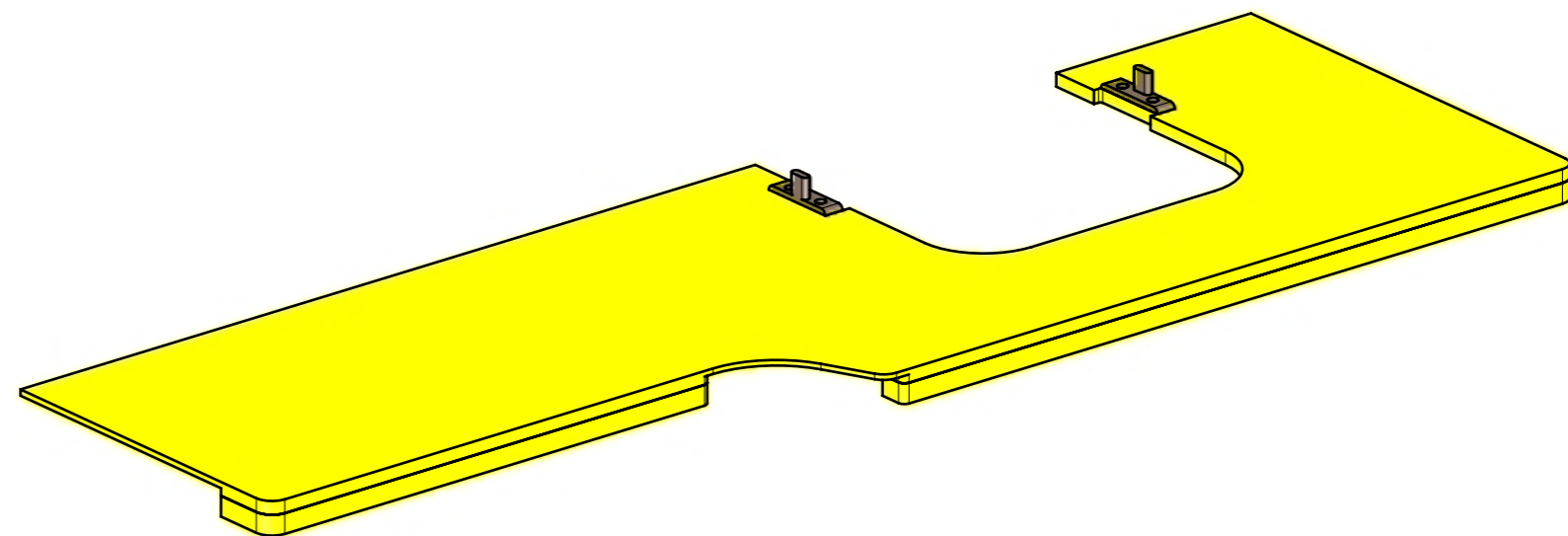

FERRAMENTA	QTY
PARTE TELAIO EHS_HAFELE_262_49_365	2