

LOCALE	CODICE	DESCRIZIONE COMPONENTE	FINITURA	GR.
LOBBY MD	MD320_P01_CCF01	MOBILE AD ANGOLO INGRESSO SALONE	FAGGIO/GOMMA NERA	4

GOMMA NERA sp 4 mm

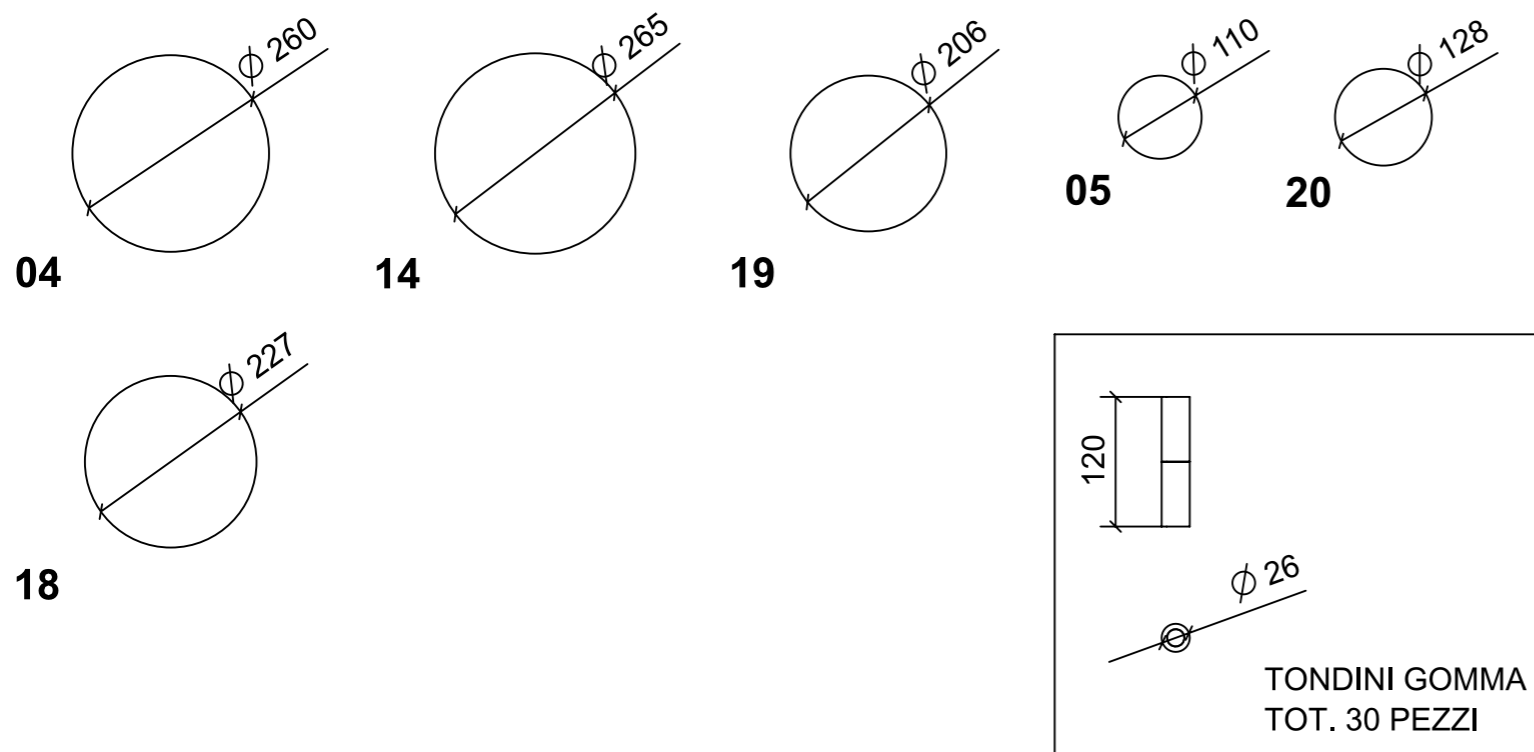

GOMMA NERA sp 19 mm

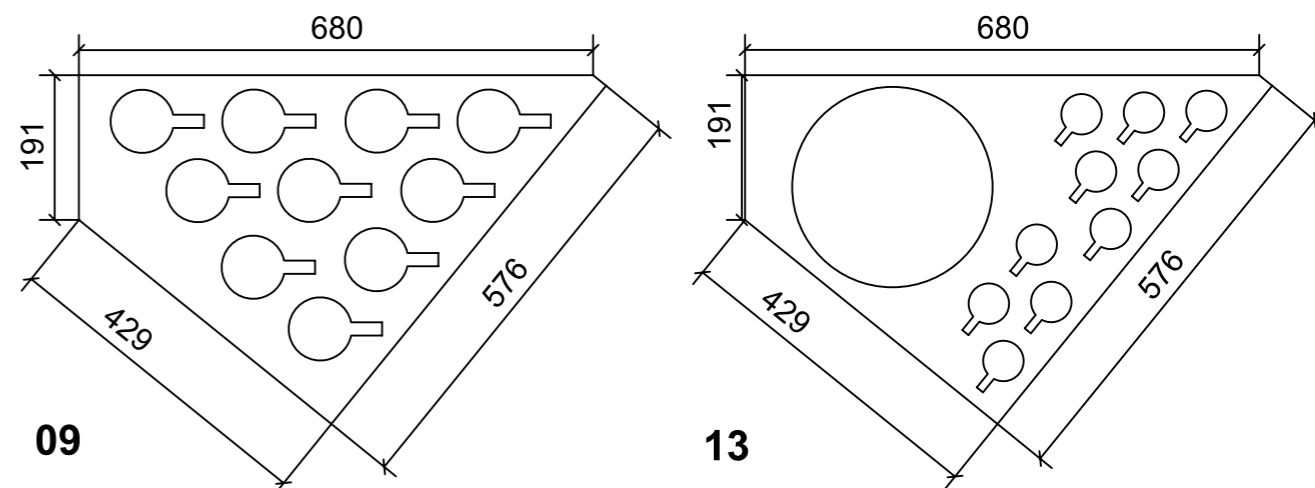

FAGGIO sp 19 mm

