

LOCALE	CODICE	DESCRIZIONE COMPONENTE	FINITURA	GR.
LOBBY MD	MD320_A01_CCI01	CIELINO	ACCIAIO GREZZO	PTP

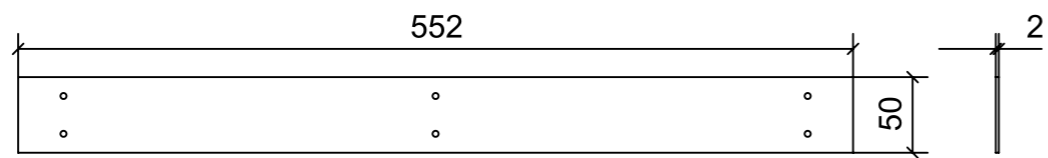

A10_CCI01_01

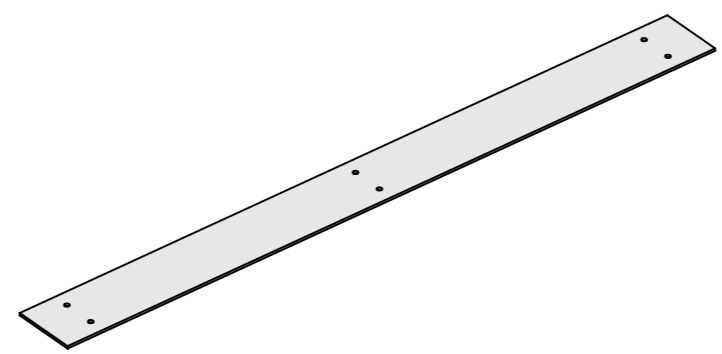

LOCALE	CODICE	DESCRIZIONE COMPONENTE	FINITURA	GR.
LOBBY MD	MD320_A01_CCM01	RIV. GRADINO PORTA SCORREVOLE	ACCIAIO VERNICIATO A POLVERE NERO	PTP

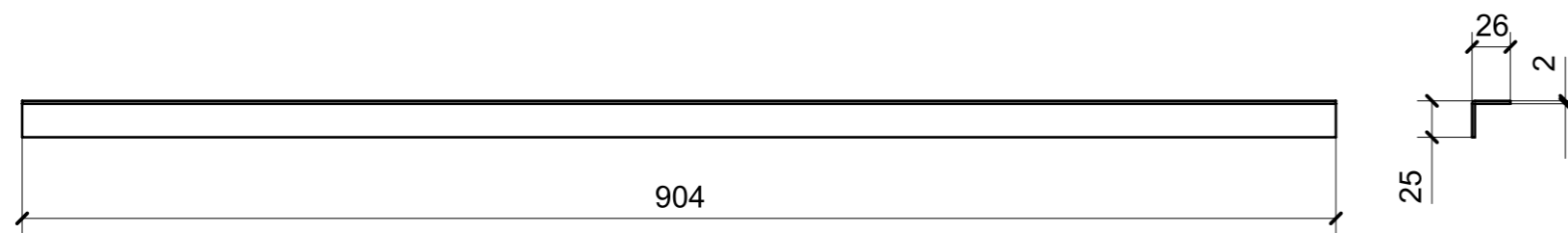

A33_CCM01_01

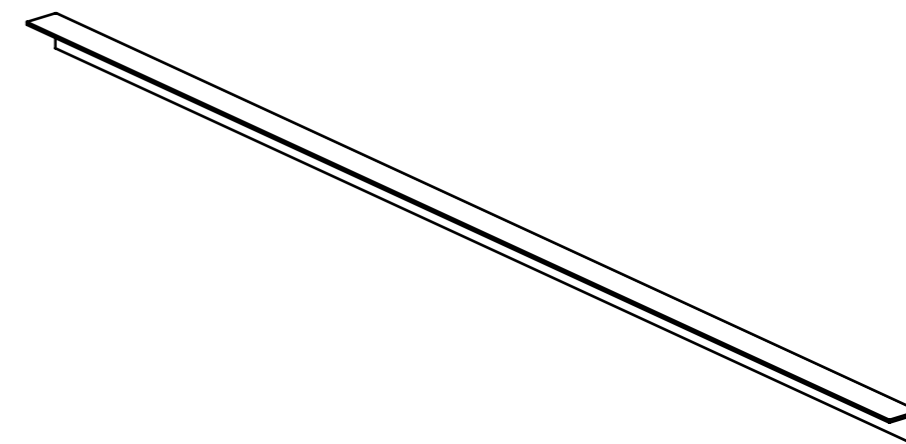

LOCALE	CODICE	DESCRIZIONE COMPONENTE	FINITURA	GR.
LOBBY MD	MD320_A01_CCN01	STRUTTURA RIV. DI POPPA PORTA SCORREVOLE	ACCIAIO GREZZO	3

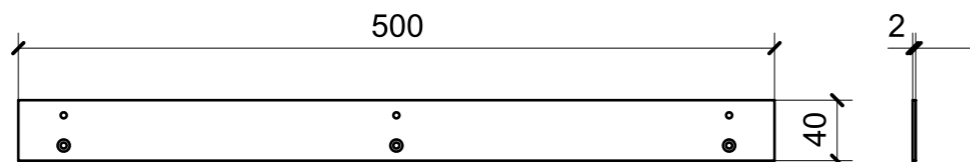

A10_CCN01_01

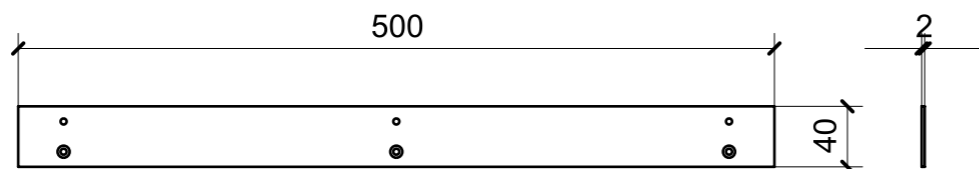

A10_CCN01_02

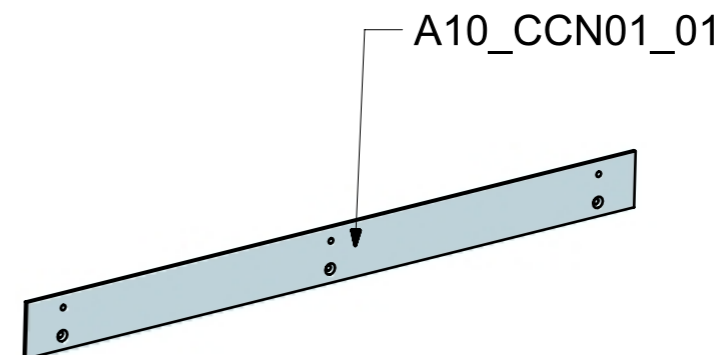

A10_CCN01_01

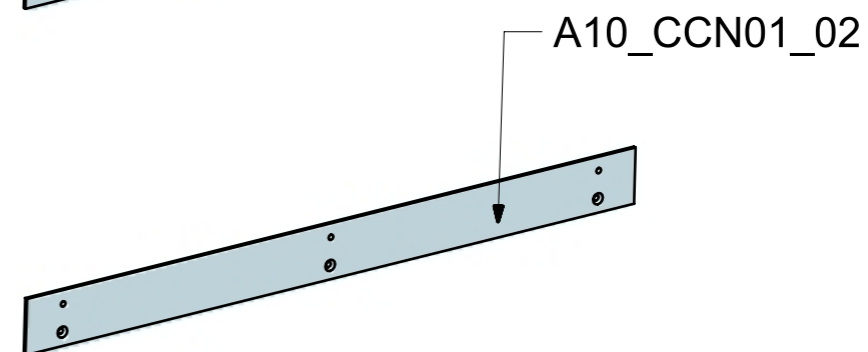

A10_CCN01_02

LOCALE	CODICE	DESCRIZIONE COMPONENTE	FINITURA	GR.
LOBBY MD	MD320_A01_CCO01	RIV. PARATIA IMPIANTI DAY TOILET	ACCIAIO GREZZO	PTP

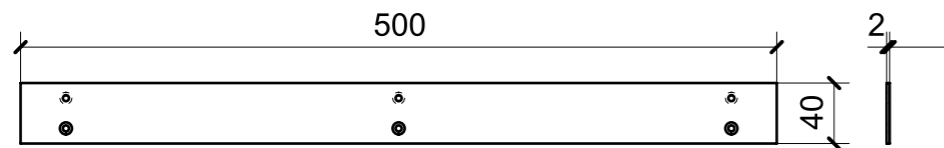

A10_COO01_01

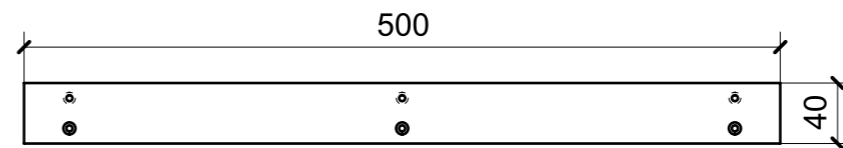

A10_COO01_02

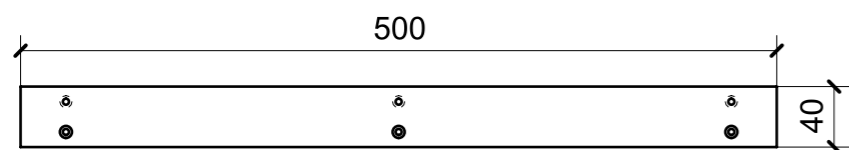

A10_COO01_03

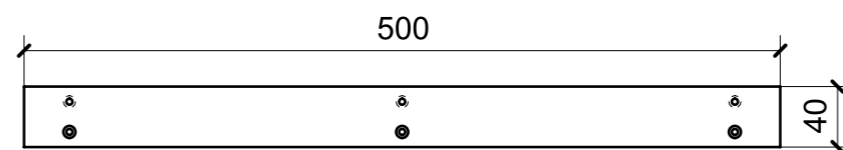

A10_COO01_04

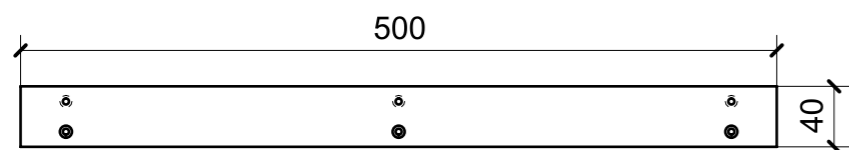

A10_COO01_05

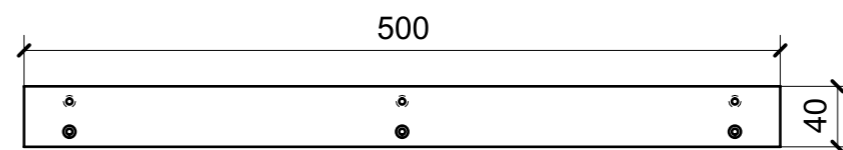

A10_COO01_06

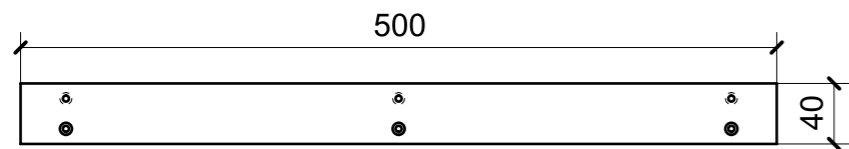

A10_COO01_07

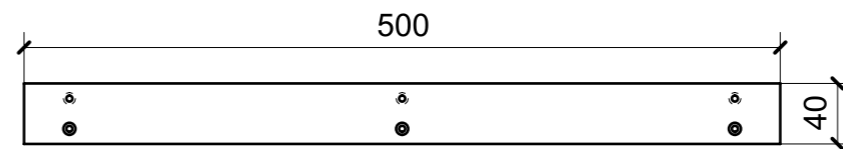

A10_COO01_08

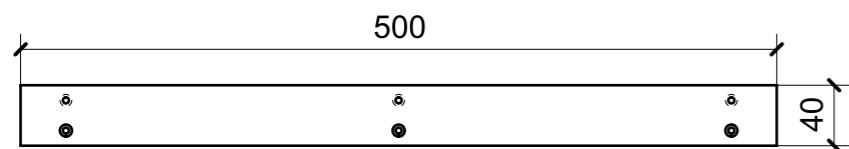

A10_COO01_09

SPESSORE 2 mm

