

LOCALE	CODICE	DESCRIZIONE COMPONENTE	FINITURA	Q.TA
BAGNO OSPITI DX	MD299_L01_ZD01	CELINO LAVABO	LACCATO BIANCO 9010	1

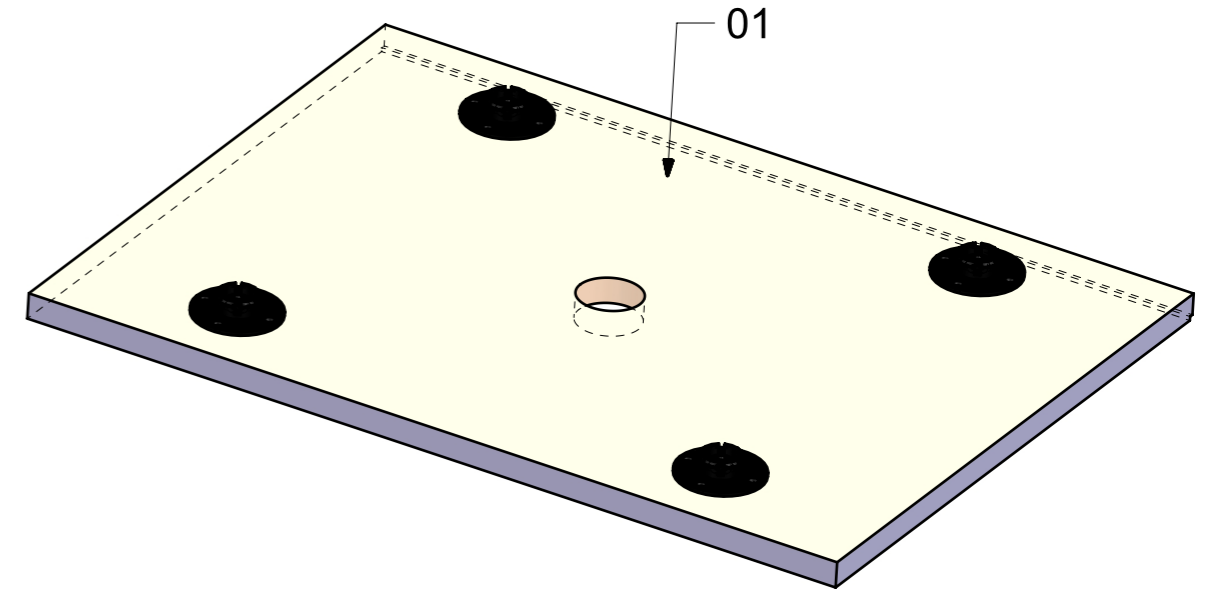
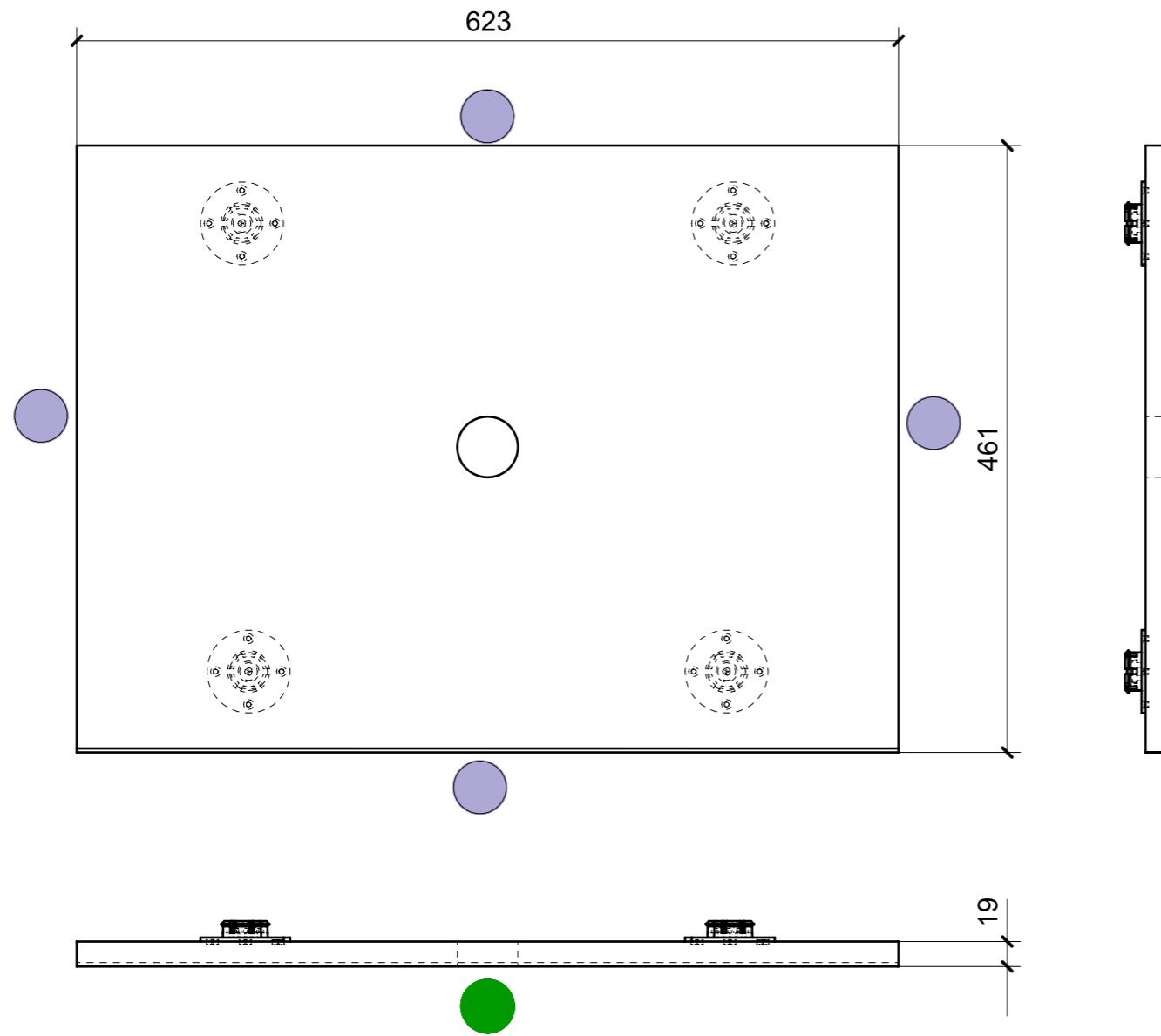

FERRAMENTA	QTY
FITLOCK M_MASCHERPA_3MM_6020202101	4

01

● = FILI RASATI

VERNICIATURA LASTRA/LACCATI:

● = VERNICIARE 1 LATO + FILI RASATI O BORDATI

NESSUN SIMBOLO = VERNICIARE 2 LATI + FILI RASATI O BORDATI

LOCALE	CODICE	DESCRIZIONE COMPONENTE	FINITURA	Q.TA
BAGNO OSPITI DX	MD299_L01_ZE01	PLENUM BAGNO	LACCATO BIANCO 9010	1

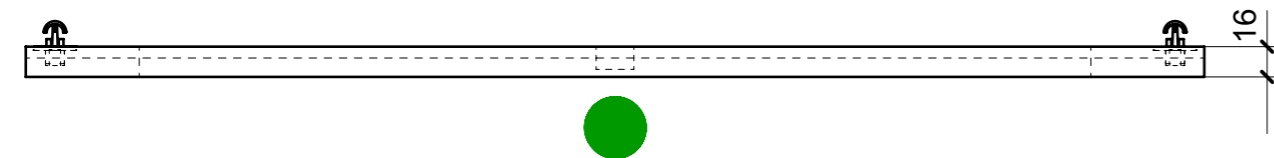
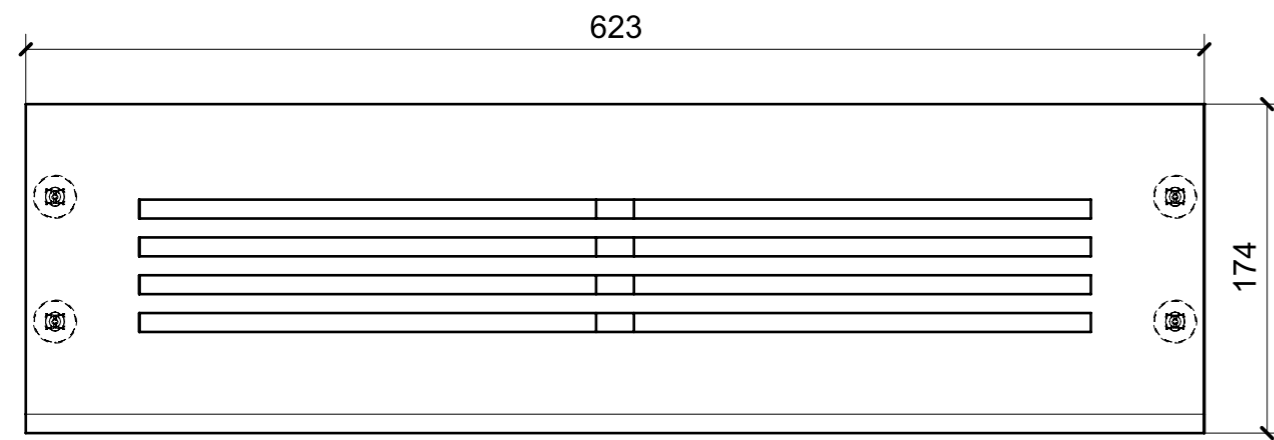

01

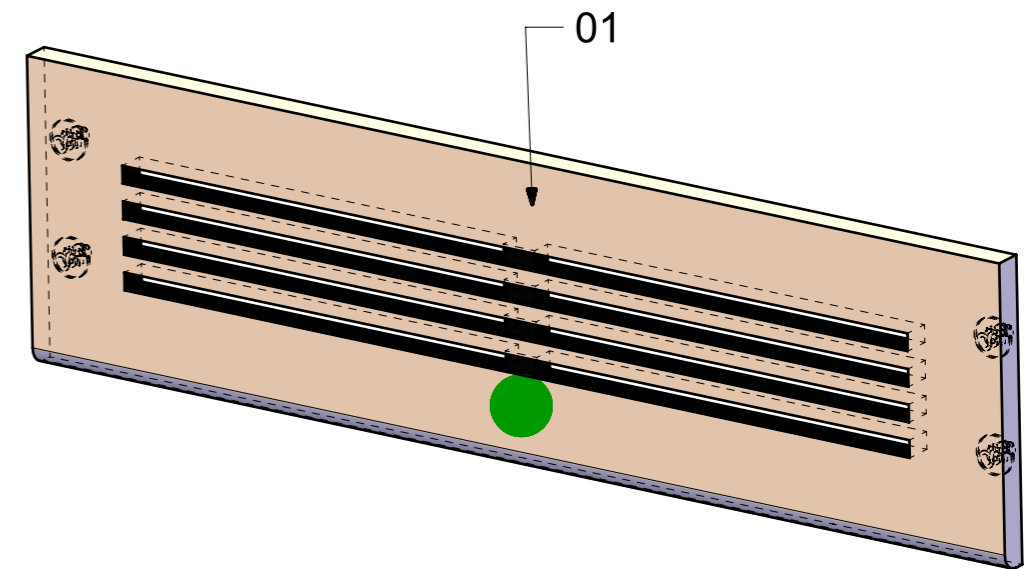

FERRAMENTA	QTY
MS INCASSO_ITALVIPLA_972_FMPC_M1B	4

VERNICIATURA LASTRA/LACCATI:

● = VERNICIARE 1 LATO + FILI RASATI O BORDATI

NESSUN SIMBOLO = VERNICIARE 2 LATI + FILI RASATI O BORDATI

LOCALE	CODICE	DESCRIZIONE COMPONENTE	FINITURA	Q.TA
BAGNO OSPITI DX	MD299_L01_ZI01	CIELINO BAGNO	LACCATO BIANCO 9010	1

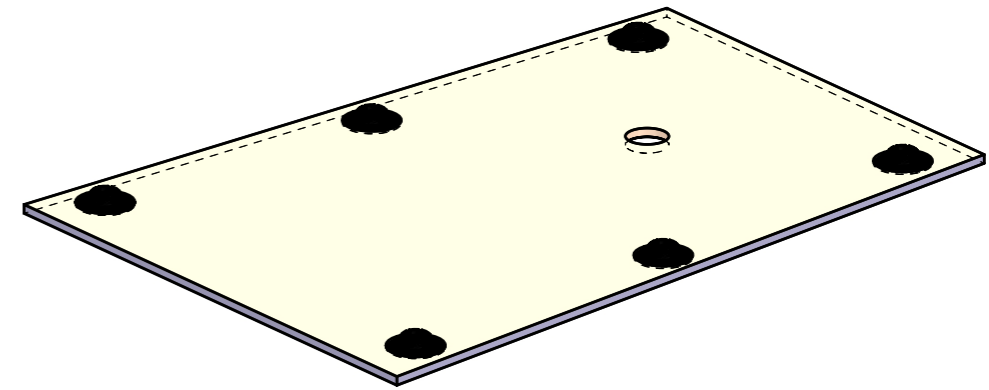
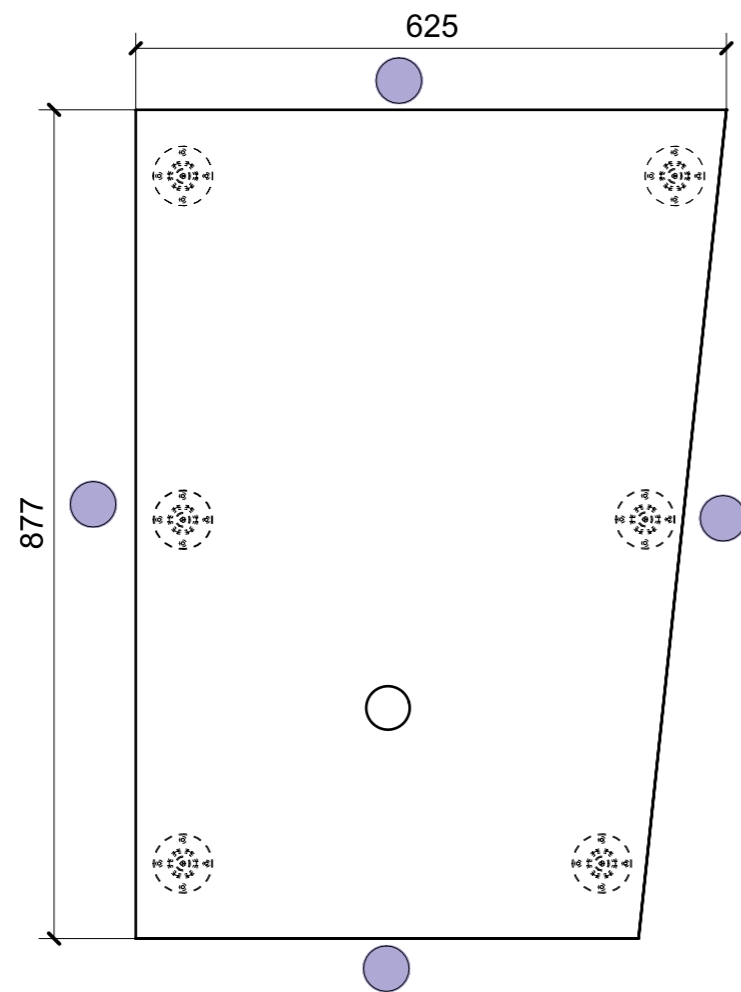

FERRAMENTA	QTY
FITLOCK M_MASCHERPA_3MM_6020202101	6

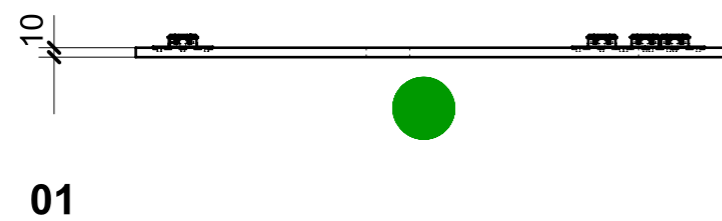

VERNICIATURA LASTRA/LACCATI:
 ● = FILI RASATI ● = VERNICIARE 1 LATO + FILI RASATI O BORDATI NESSUN SIMBOLO = VERNICIARE 2 LATI + FILI RASATI O BORDATI

LOCALE	CODICE	DESCRIZIONE COMPONENTE	FINITURA	Q.TA
BAGNO OSPITI DX	MD299_L01_ZM01	PARETE TRA DOCCIA E BAGNO	LACCATO BIANCO 9001-100 gloss	1

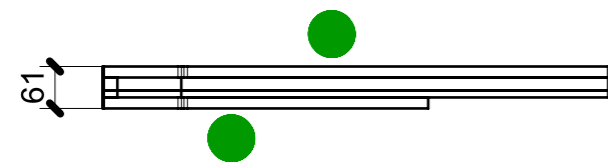
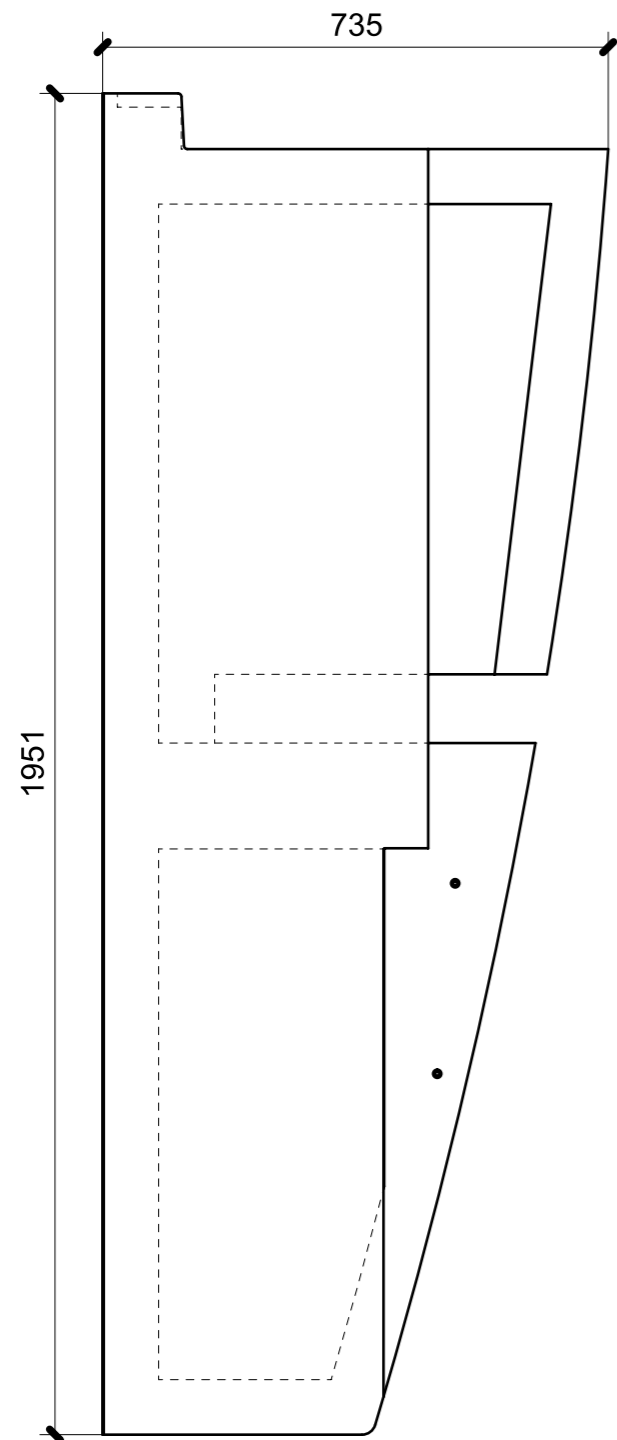

01

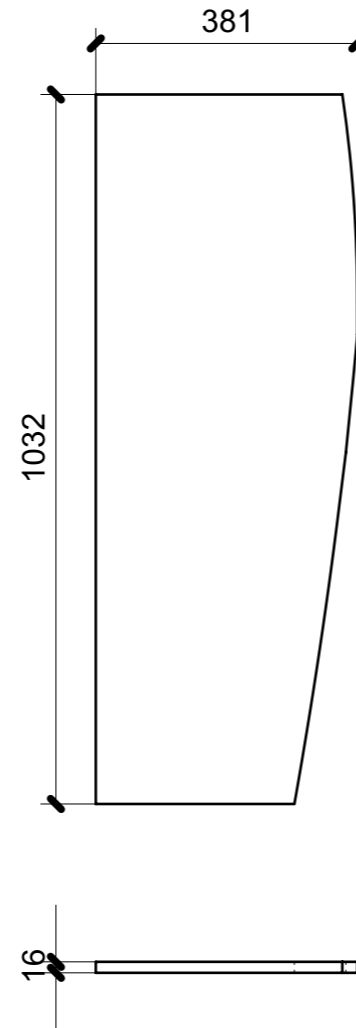

02

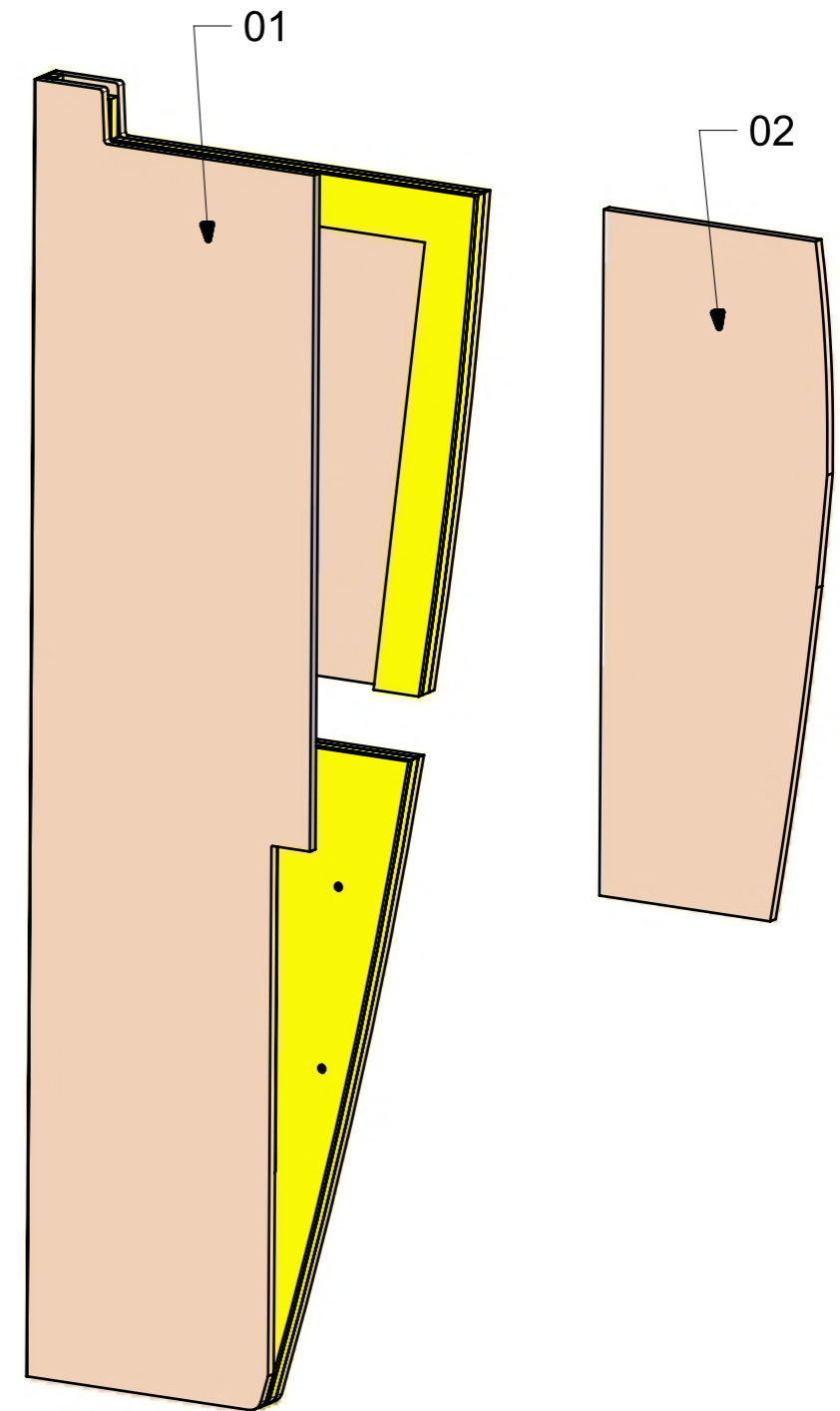

FERRAMENTA	QTY
BUSSOLA 6MA X 10 FORO DIAM.8	2

VERNICIATURA LASTRA/LACCATI:

● = VERNICIARE 1 LATO + FILI RASATI O BORDATI

NESSUN SIMBOLO = VERNICIARE 2 LATI + FILI RASATI O BORDATI

LOCALE	CODICE	DESCRIZIONE COMPONENTE	FINITURA	Q.TA
BAGNO OSPITI DX	MD299_L01_ZN01	SEDUTA DOCCIA	LACCATO BIANCO 9001 -100 gloss	1

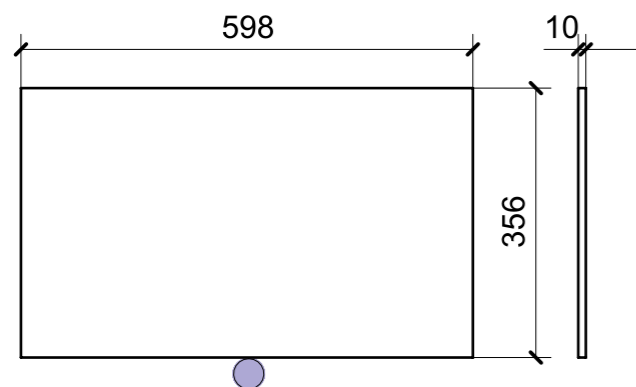

02

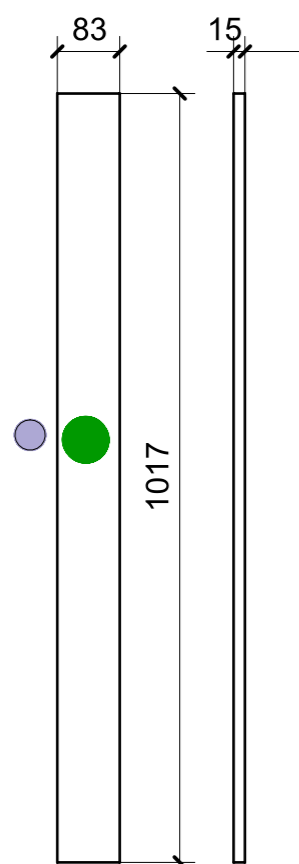
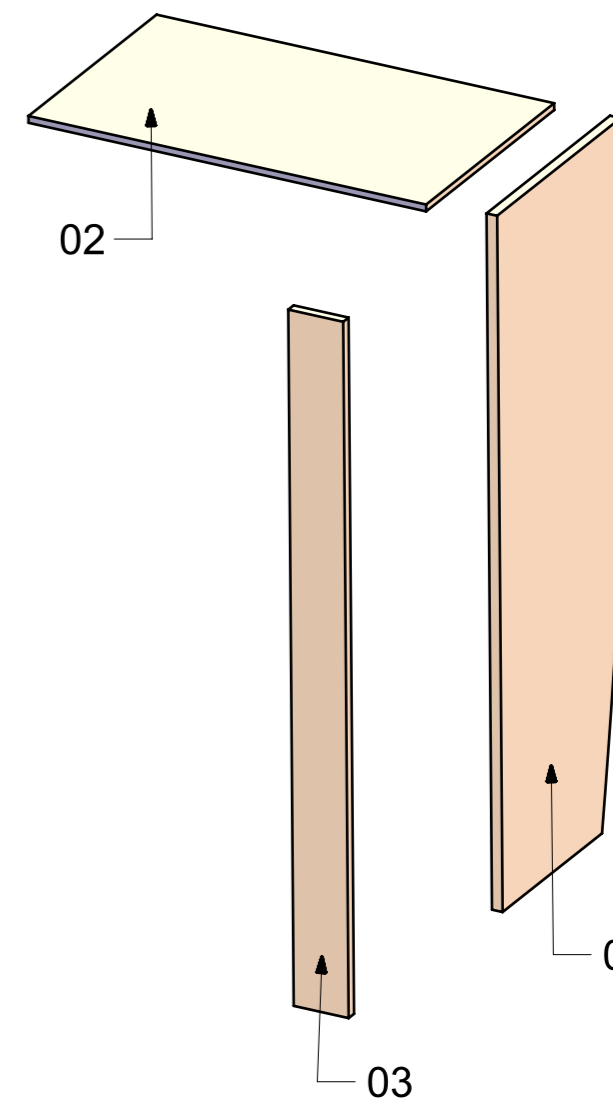

03

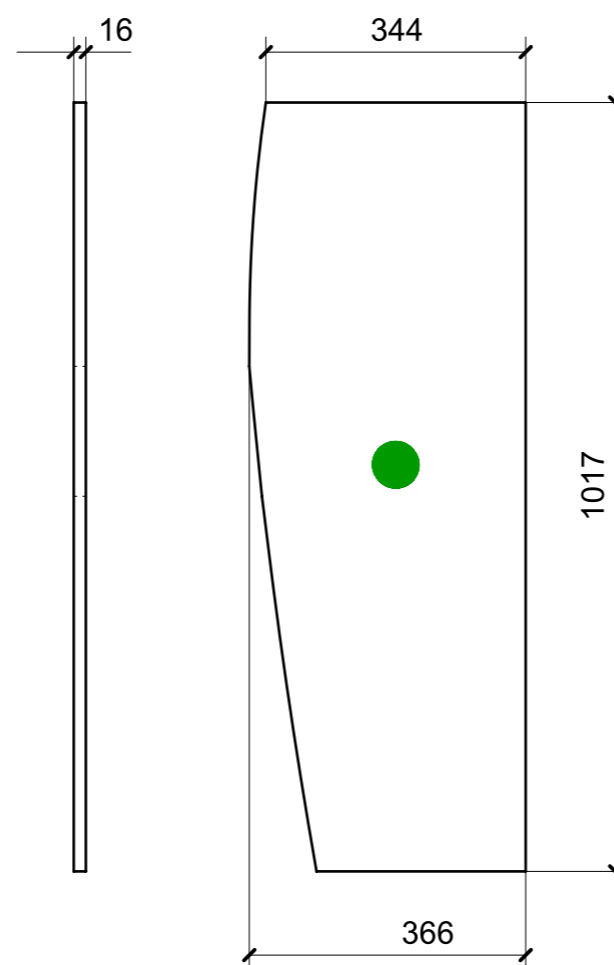

01

VERNICIATURA LASTRA/LACCATI:

● = FILI RASATI

● = VERNICIARE 1 LATO + FILI RASATI O BORDATI

NESSUN SIMBOLO = VERNICIARE 2 LATI + FILI RASATI O BORDATI

LOCALE	CODICE	DESCRIZIONE COMPONENTE	FINITURA	Q.TA
BAGNO OSPITI DX	MD299_L01_ZR01	CIELINO DOCCIA	LACCATO BIANCO 9010	1

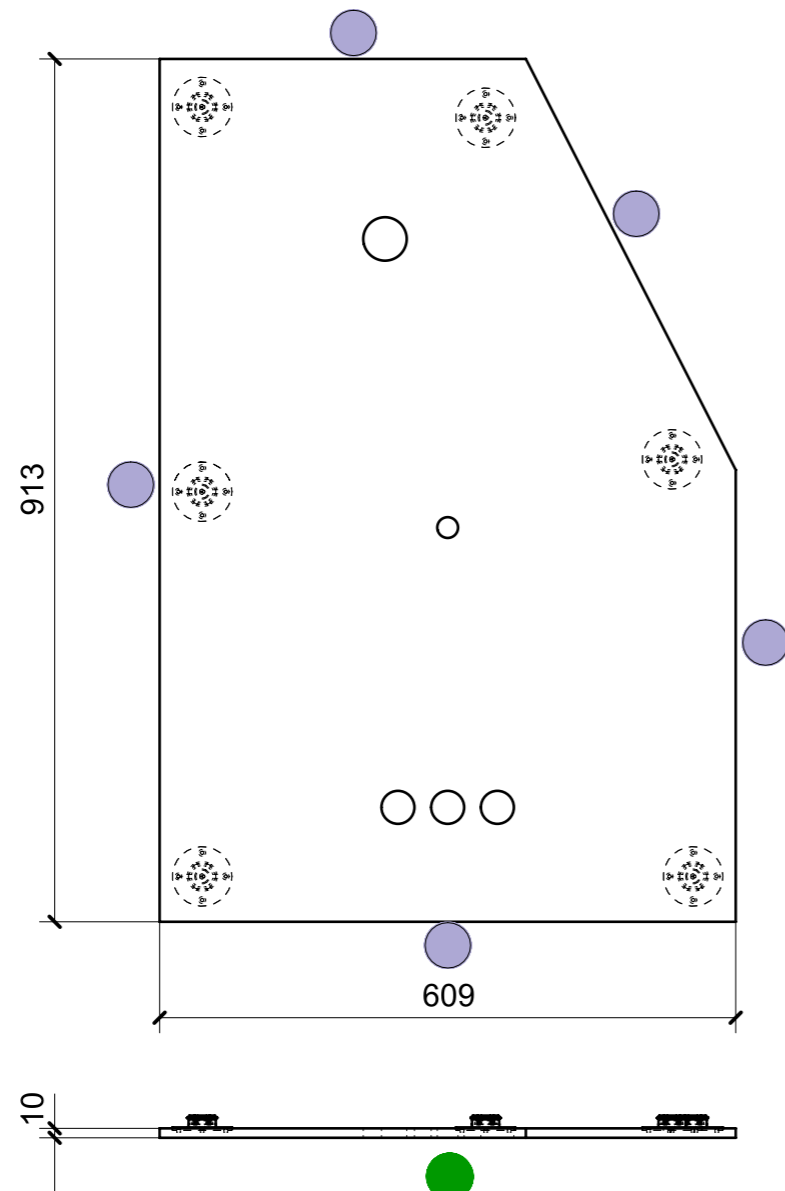

01

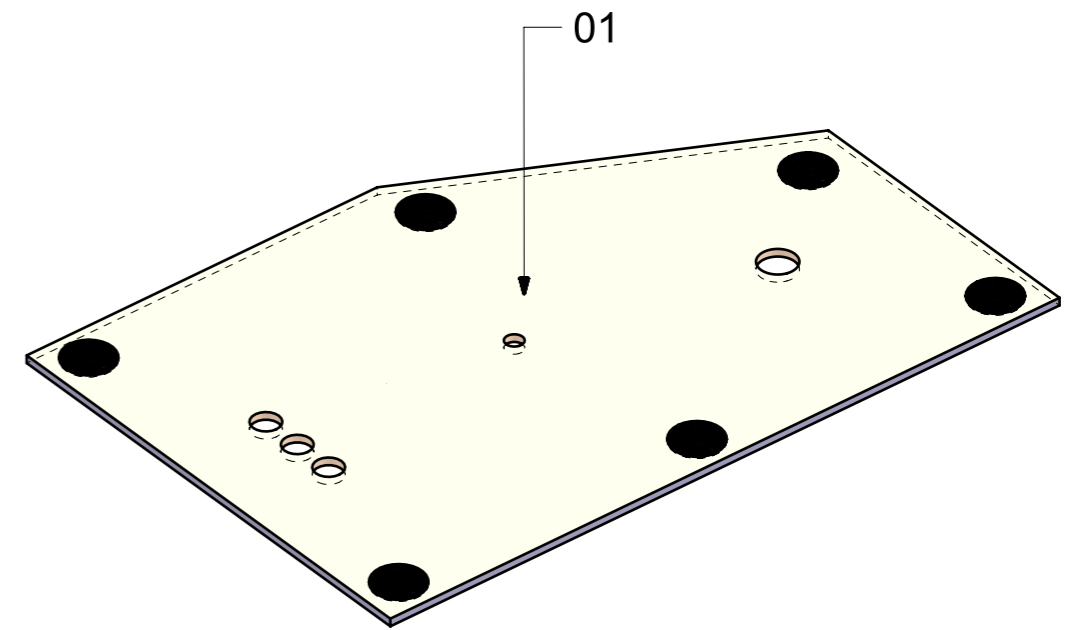

FERRAMENTA	QTY
FITLOCK M_MASCHERPA_3MM_6020202101	6

VERNICIATURA LASTRA/LACCATI:

● = FILI RASATI

● = VERNICIARE 1 LATO + FILI RASATI O BORDATI

NESSUN SIMBOLO = VERNICIARE 2 LATI + FILI RASATI O BORDATI

LOCALE	CODICE	DESCRIZIONE COMPONENTE	FINITURA	Q.TA
BAGNO OSPITI DX	MD299_L01_ZS01	ANTA BASE LAVELLO_STD VAR 2 VERDE 100 GLOSS	LACCATO VERDE NCS S 5020 B70G LUCIDO 100 gloss	1

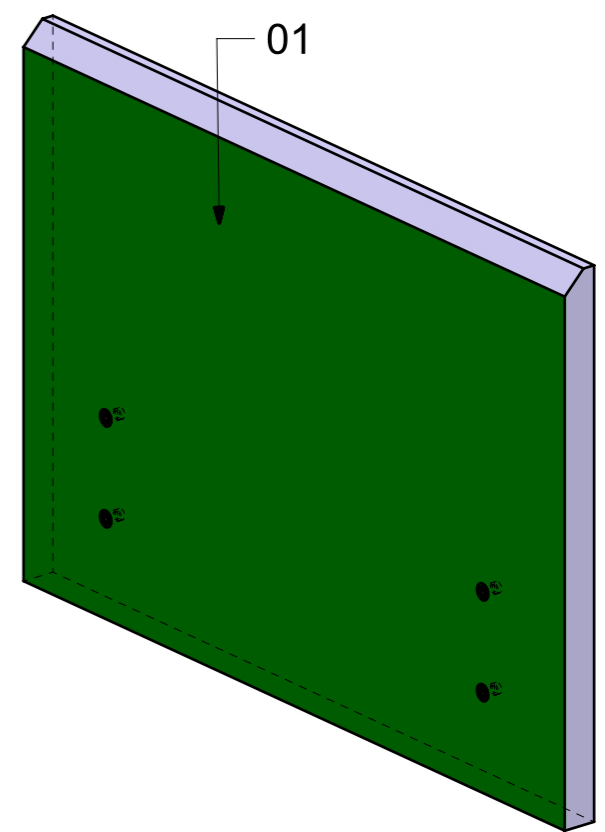
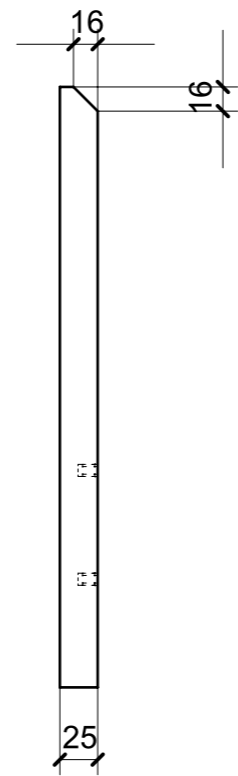
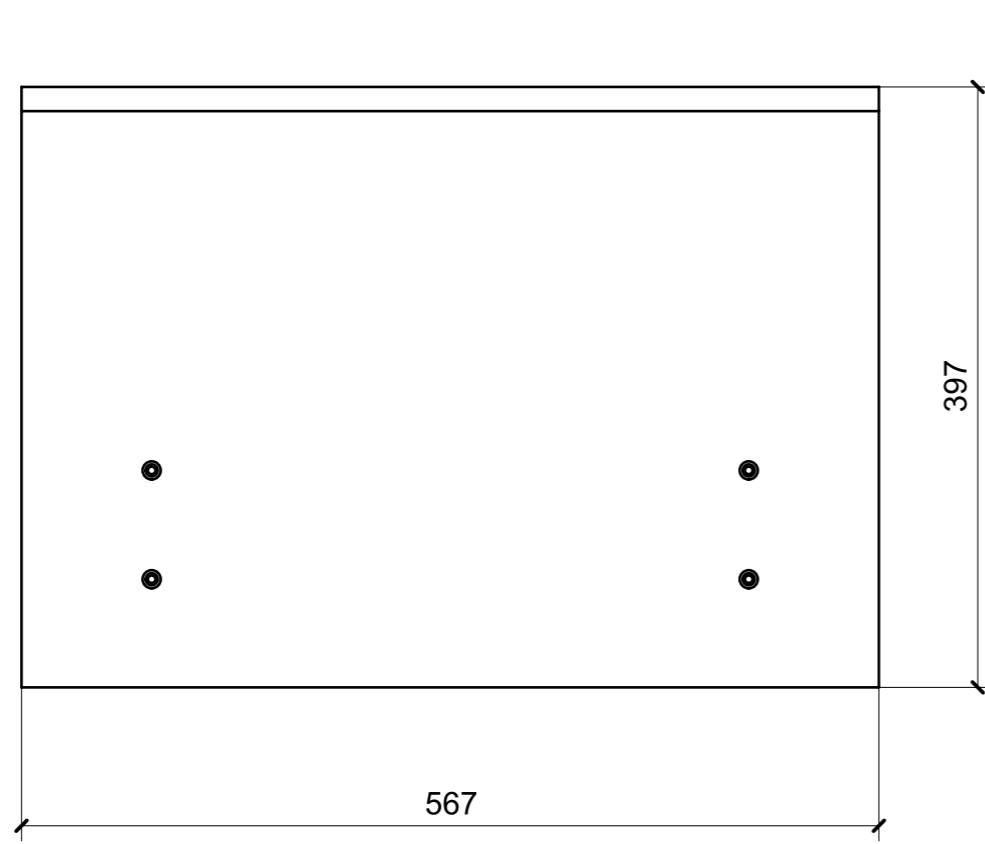

FERRAMENTA	QTY
BUSSOLA 5MA X 10 FORO DIAM.8	4

VERNICIATURA LASTRA/LACCATI:
● = VERNICIARE 1 LATO + FILI RASATI O BORDATI NESSUN SIMBOLO = VERNICIARE 2 LATI + FILI RASATI O BORDATI

LOCALE	CODICE	DESCRIZIONE COMPONENTE	FINITURA	Q.TA
BAGNO OSPITI DX	MD299_L01_ZT01	ANTA BASE LAVELLO_STD VAR 1 AZZURO-GRIGIO 100 gloss	LACCATO AZZURRO\GRIGIO NCS S 3005 B 80 G 100 gloss	1

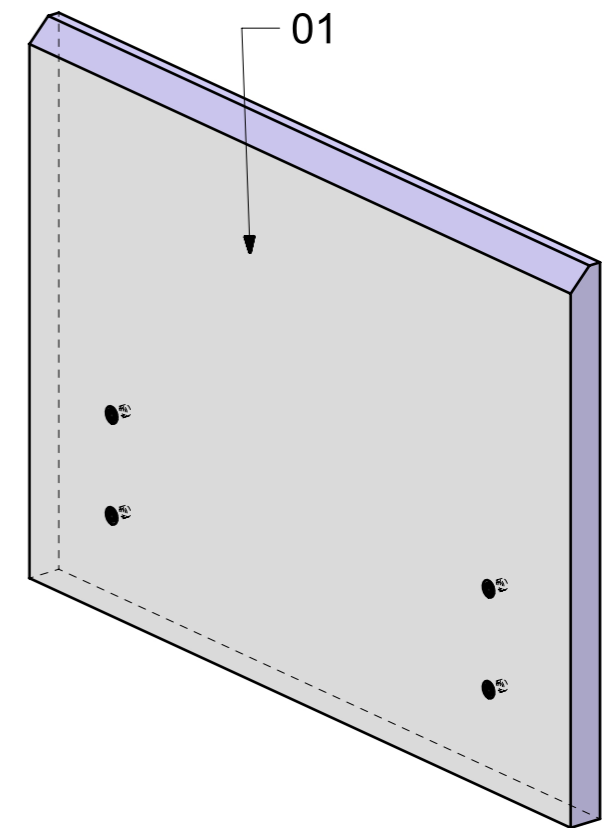
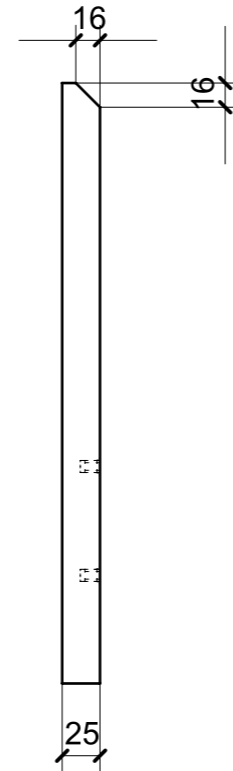
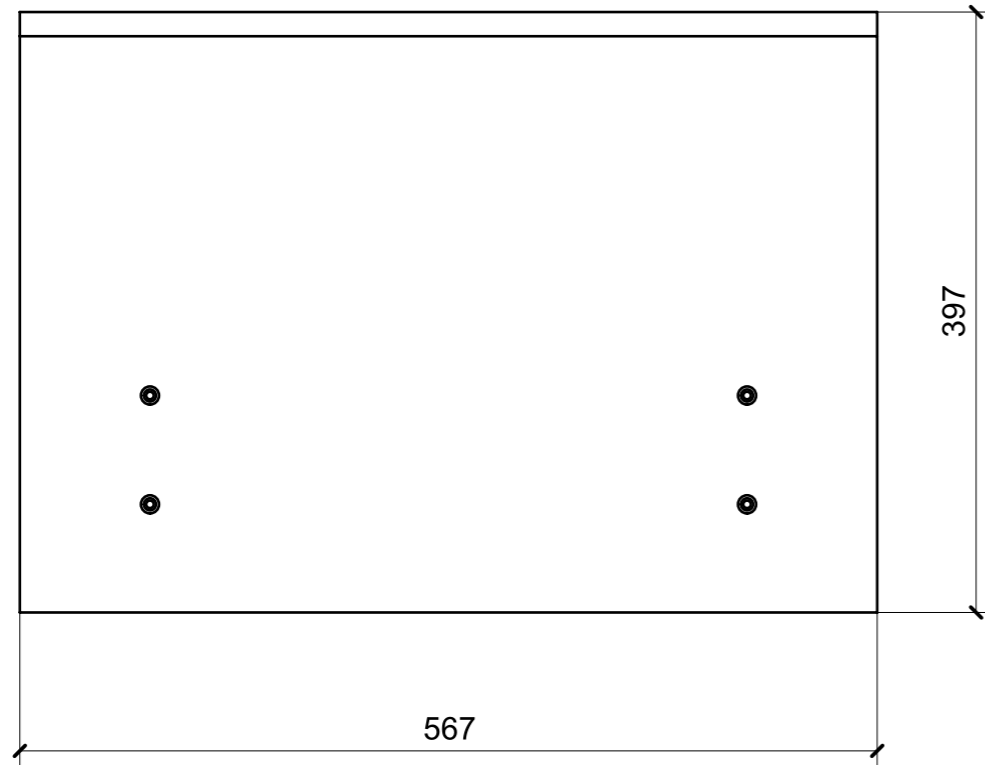

FERRAMENTA	QTY
BUSSOLA 5MA X 10 FORO DIAM.8	4

VERNICIATURA LASTRA/LACCATI:

● = VERNICIARE 1 LATO + FILI RASATI O BORDATI

NESSUN SIMBOLO = VERNICIARE 2 LATI + FILI RASATI O BORDATI