

LOCALE	CODICE	DESCRIZIONE COMPONENTE	FINITURA	GR.
BAGNO VIP SX	MD320_MF_JJD01	SEDUTA DOCCIA		2

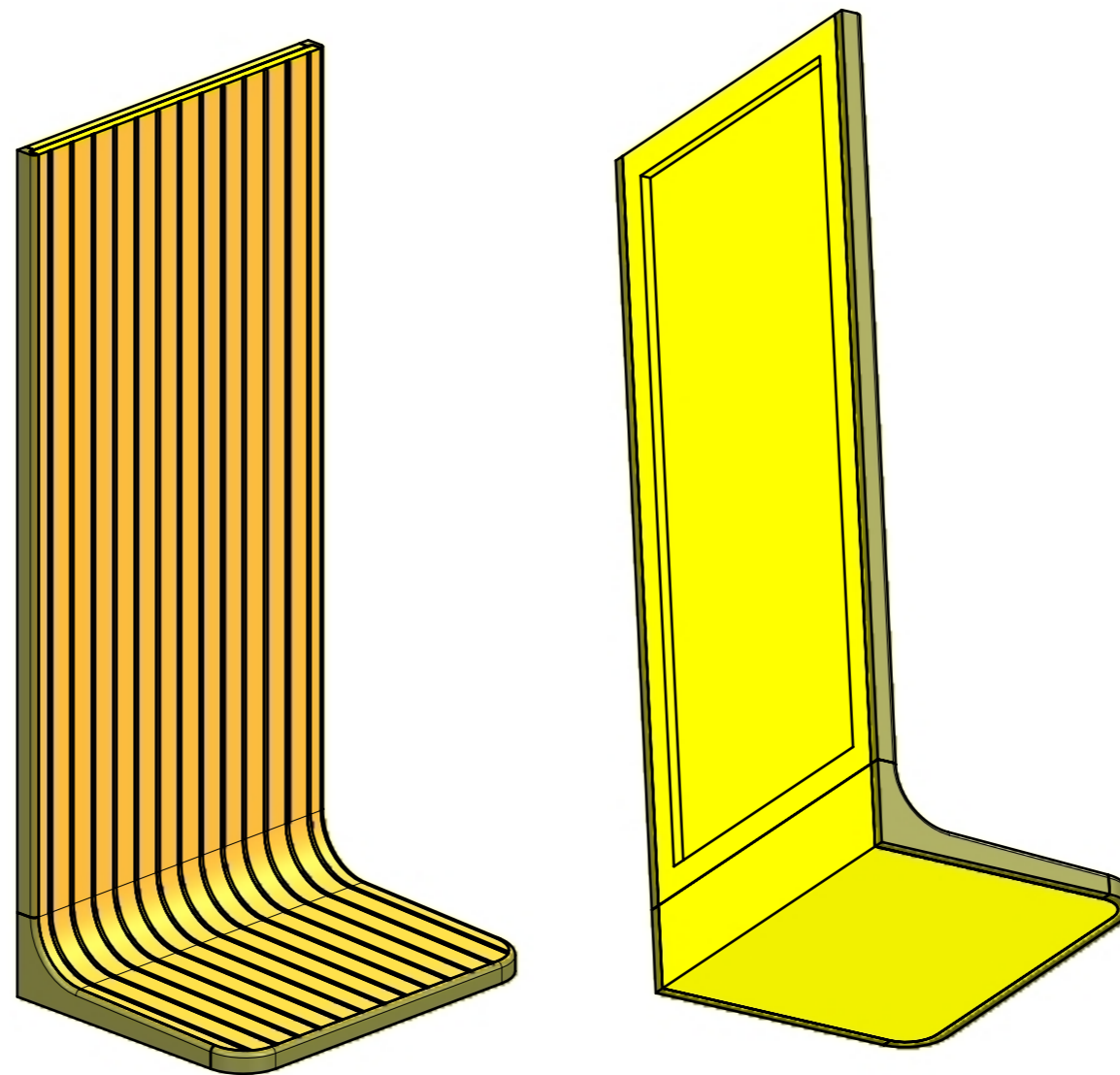

ELEMENTI DA MONTARE  
in MF\_JJD01  
e spedire con unico imballo

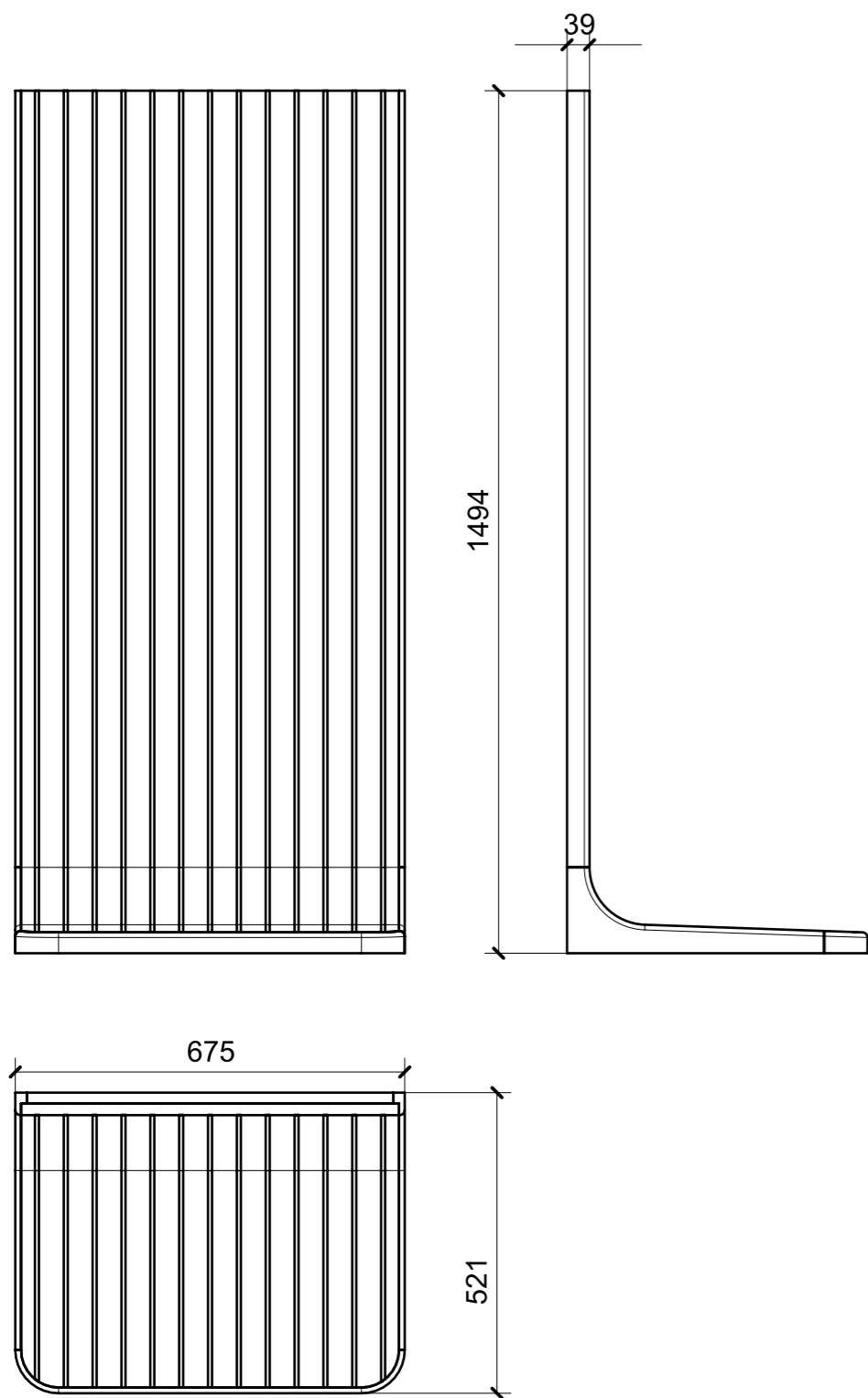
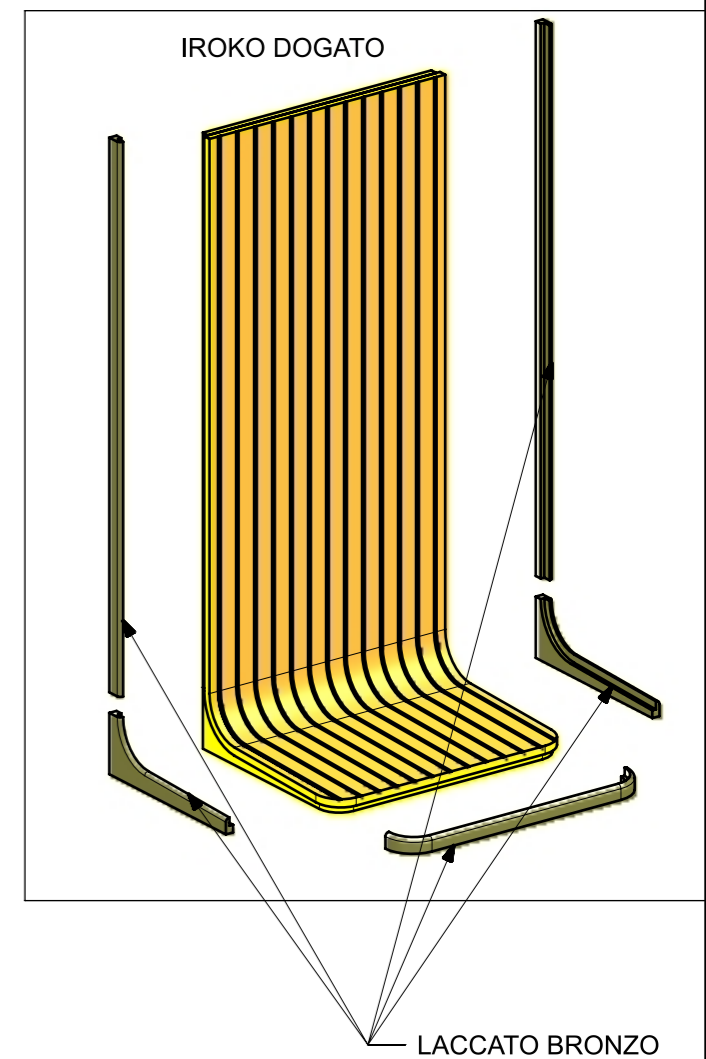

LOCALE	CODICE	DESCRIZIONE COMPONENTE	FINITURA	GR.
BAGNO VIP SX	MD320_MF_JJE01	SCATOLA CORPO MISCELATORI		2

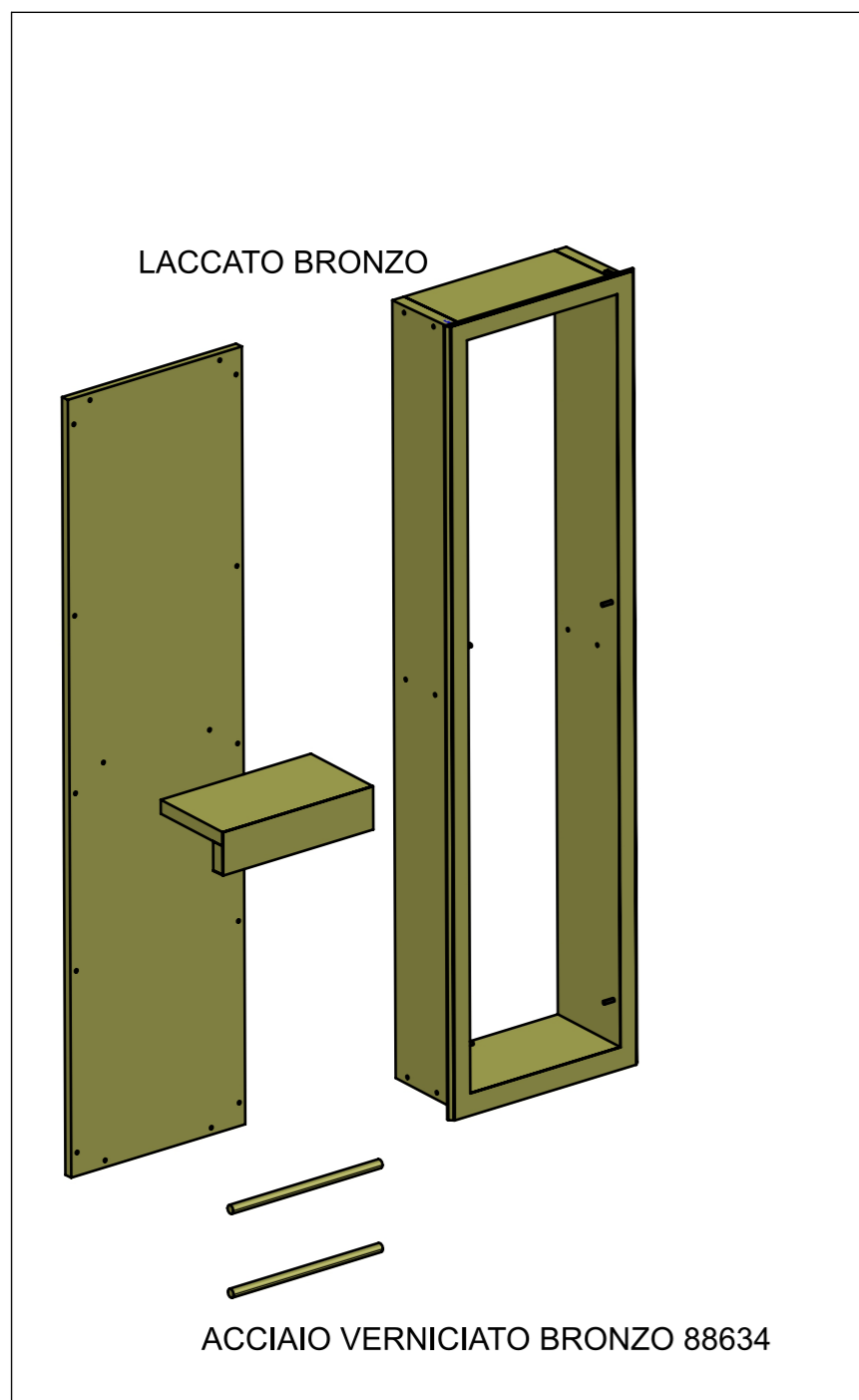

→  
ELEMENTI DA MONTARE  
in MF\_JJE01  
e spedire in un unico imballo

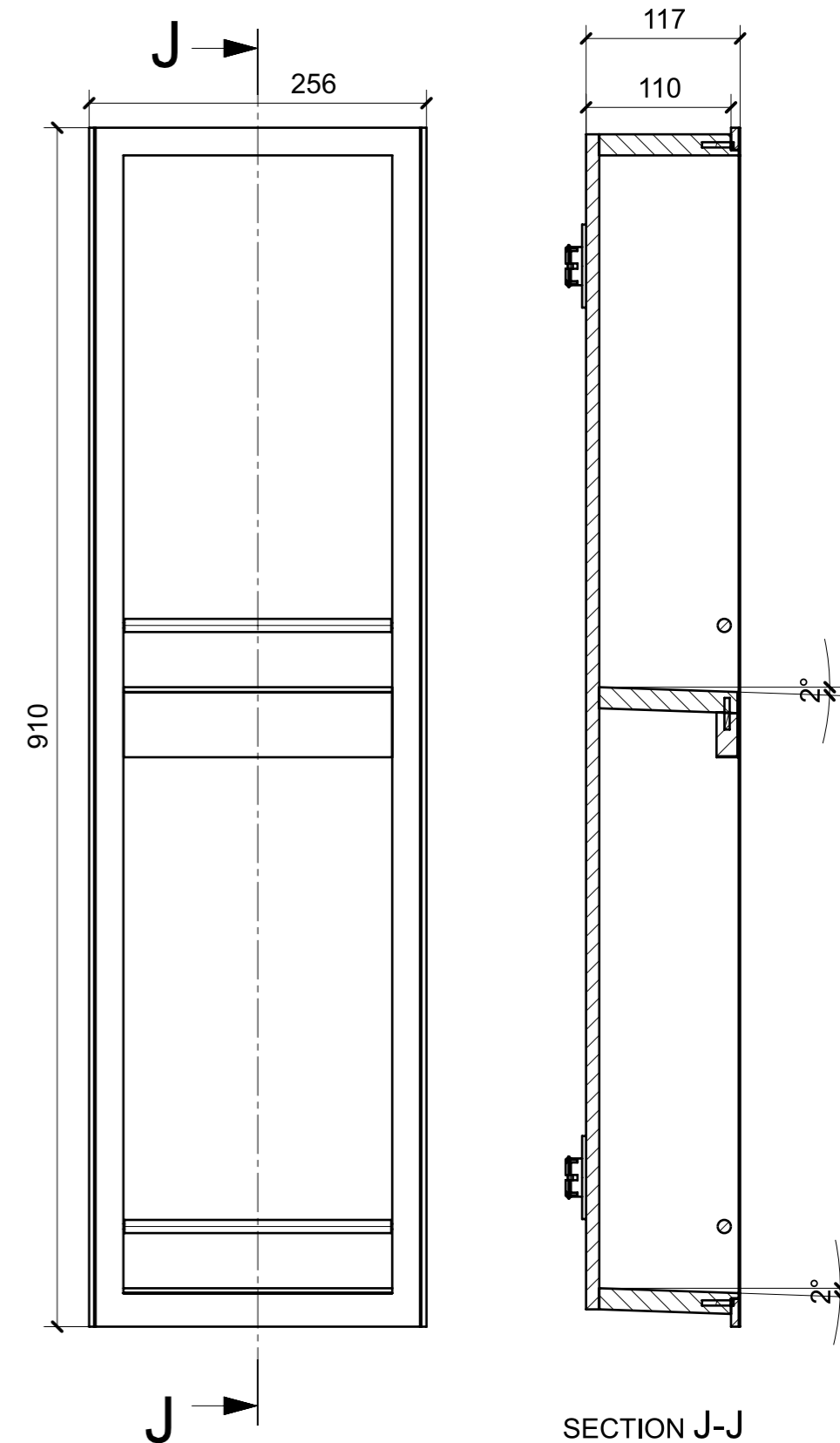
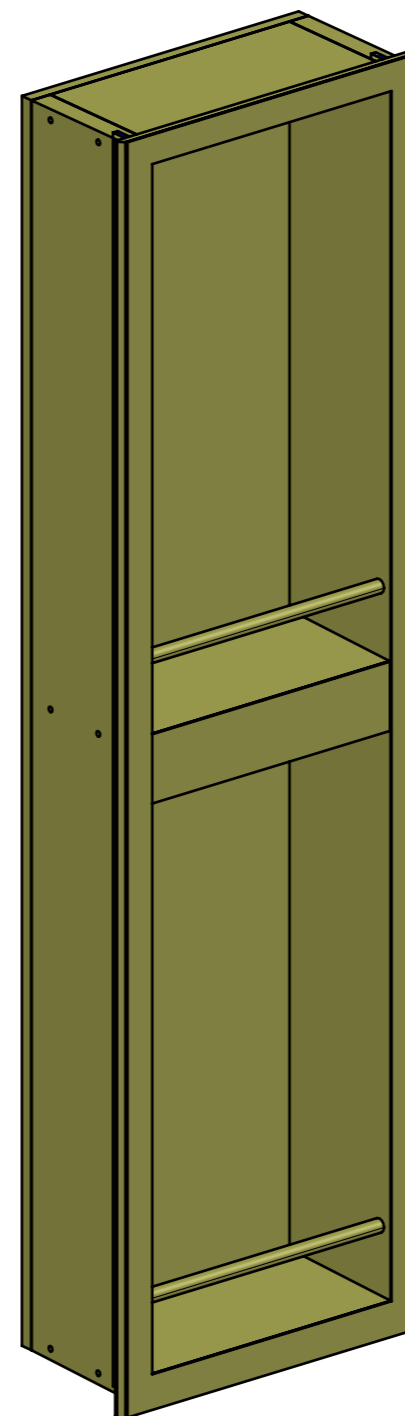

FERRAMENTA	QTY
VITE 4MA X 30 TESTA SVASATA ESAGONALE NERA_FBC_21098	4
FITLOCK M_MASCHERPA_3MM_6020202101	4

LOCALE	CODICE	DESCRIZIONE COMPONENTE	FINITURA	GR.
BAGNO VIP SX	MD320_MF_JJH01	RIV. PARETI INGRESSO BAGNO	LACCATO BRONZO	2

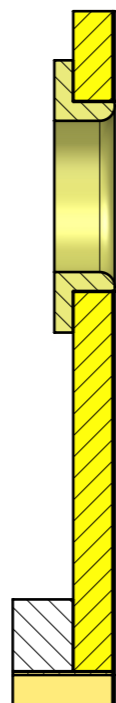
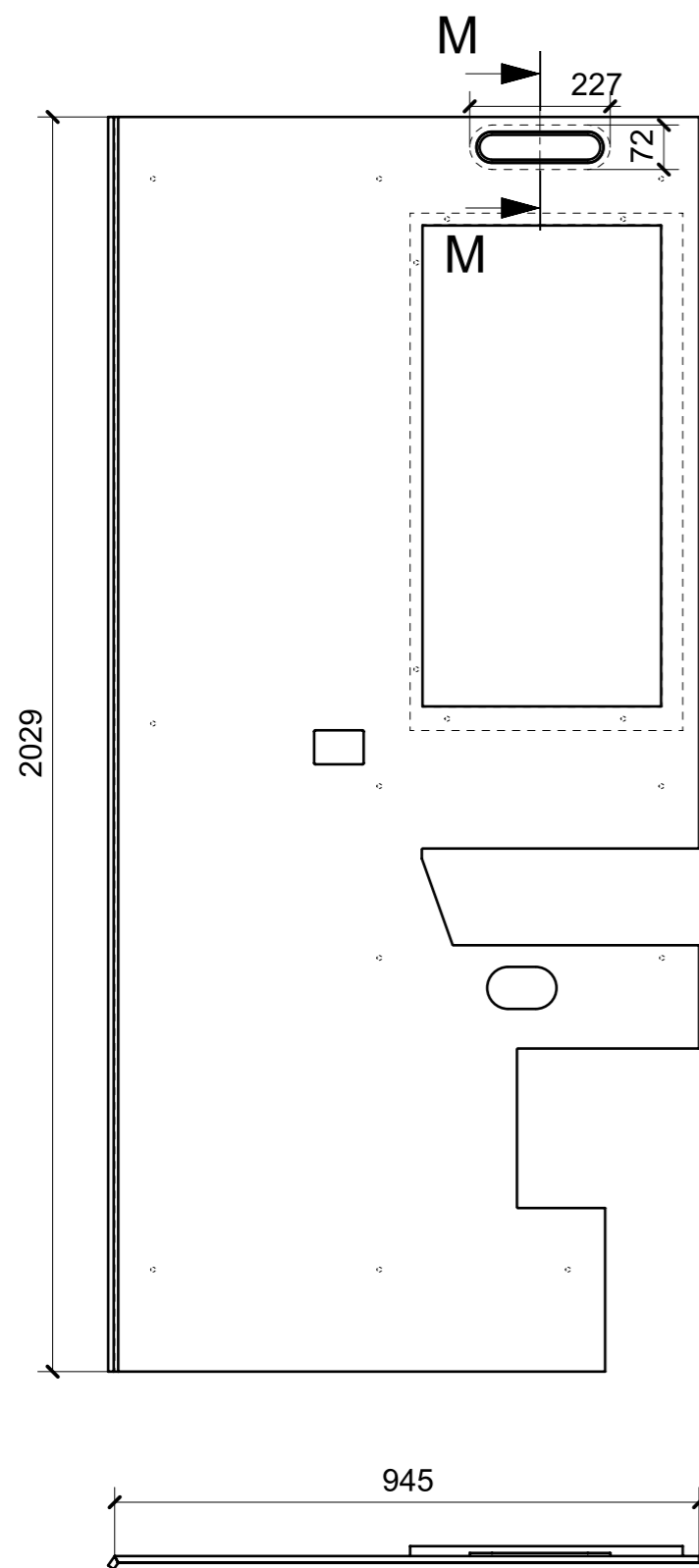

SECTION M-M  
SCALA 1:2

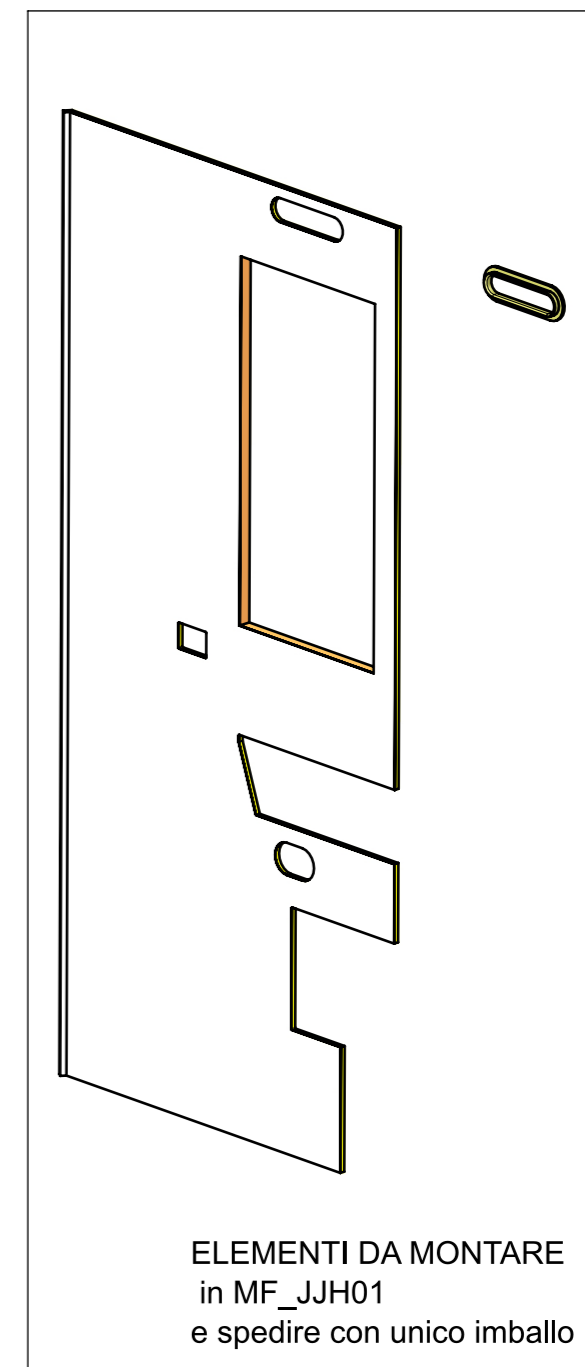
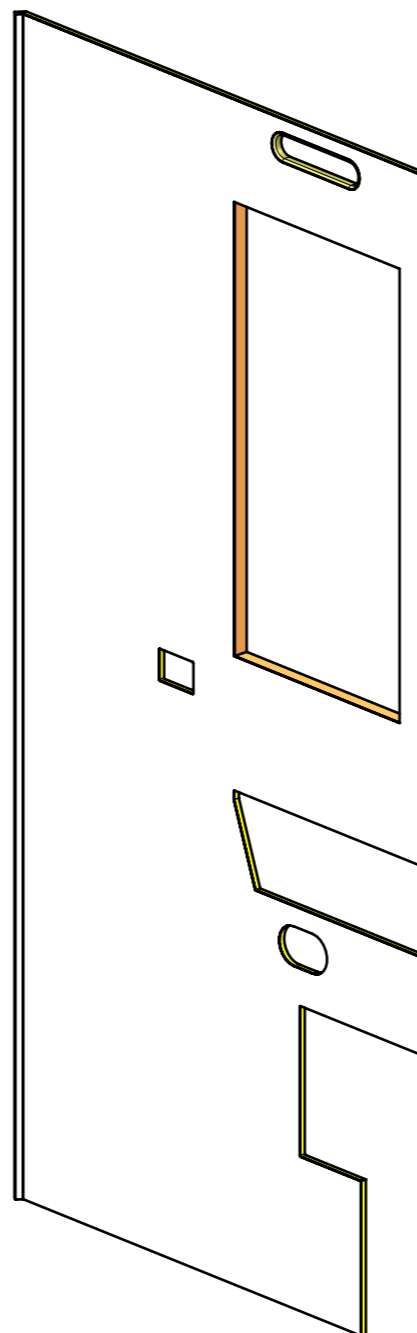

LOCALE	CODICE	DESCRIZIONE COMPONENTE	FINITURA	GR.
BAGNO VIP SX	MD320_MF_JJI01	MOBILE SOTTO LAVELLO		3

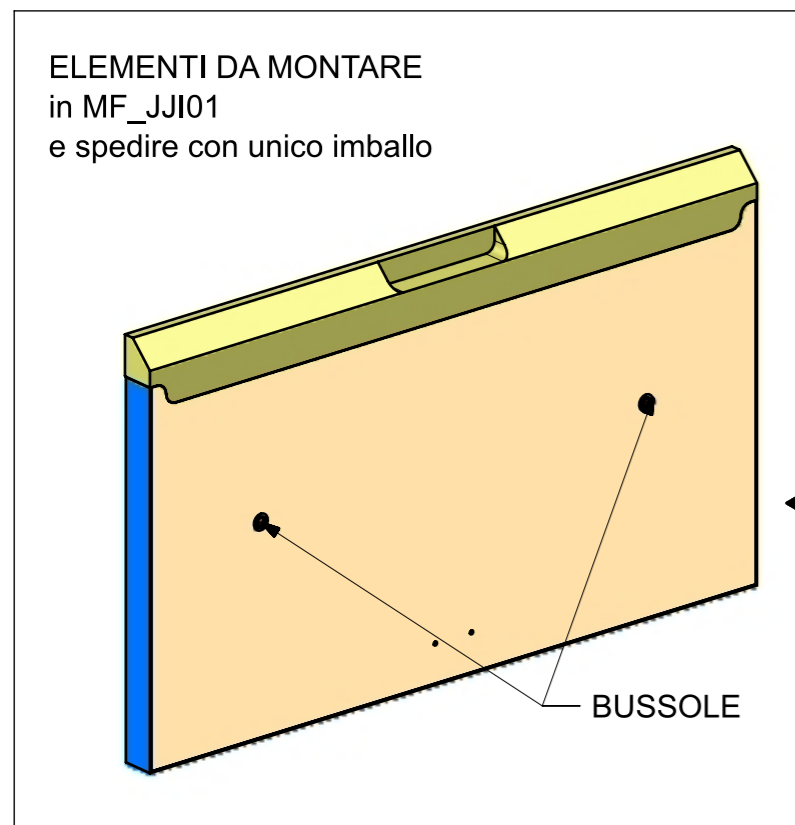

MF\_JJI01

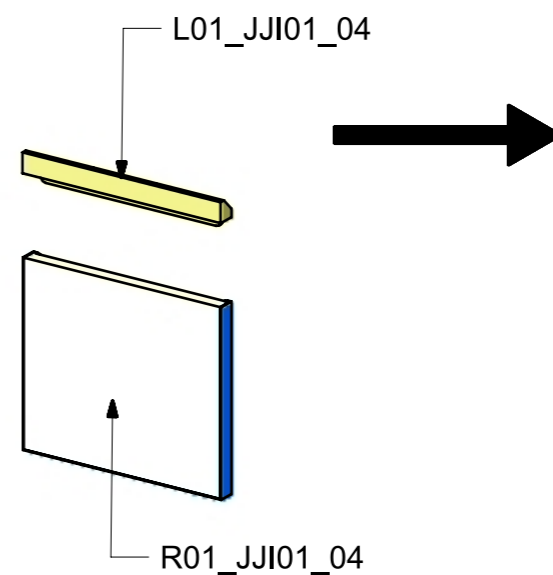
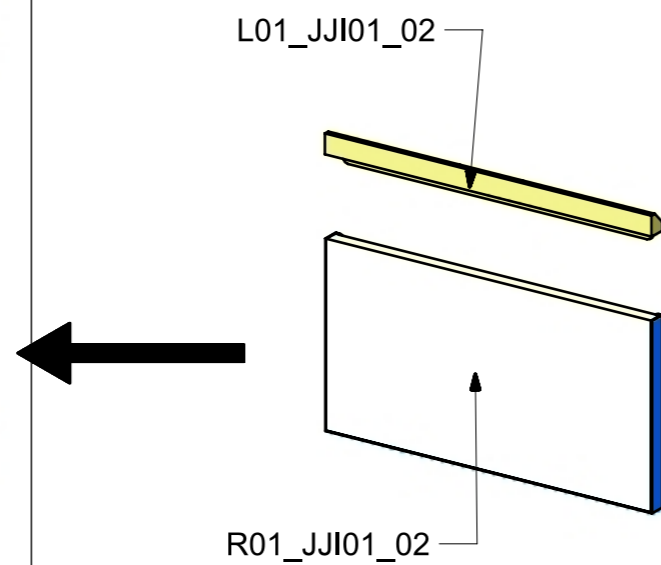

MF\_JJI02

FERRAMENTA	QTY
BUSSOLA 6MA X 10 FORO DIAM.8	4

LOCALE	CODICE	DESCRIZIONE COMPONENTE	FINITURA	GR.
BAGNO VIP SX	MD320_MF_JJN01	NICCHIA LATERALE LAVABO		2

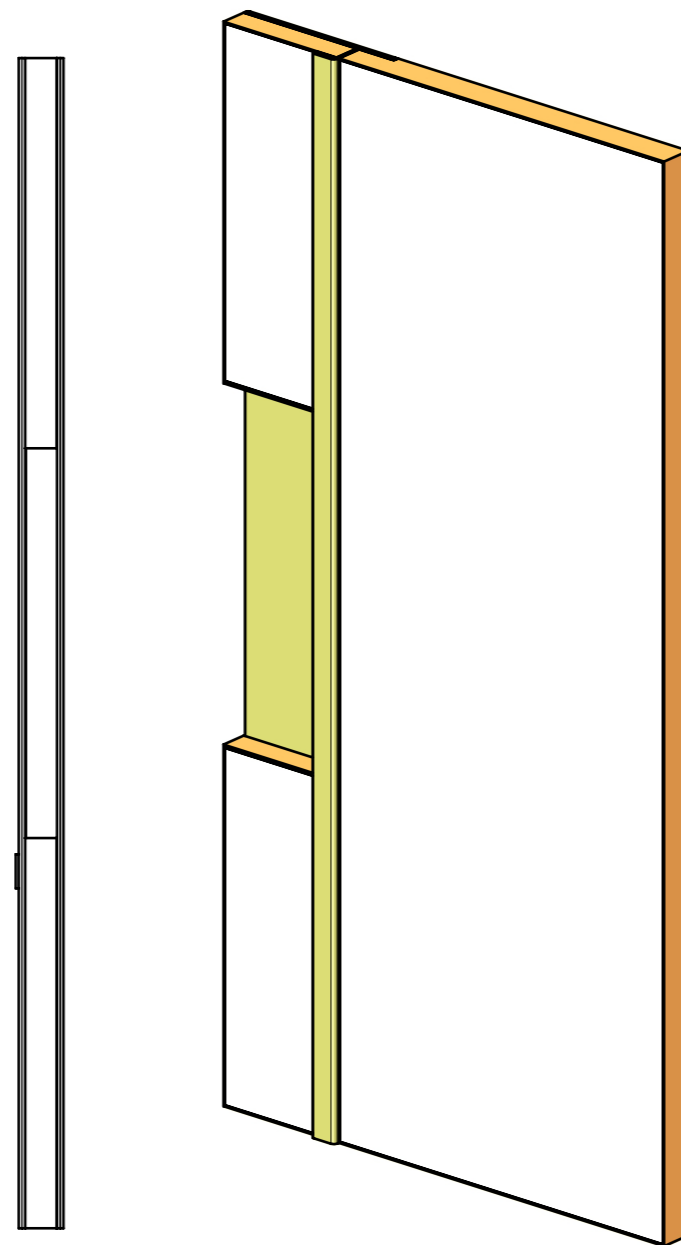
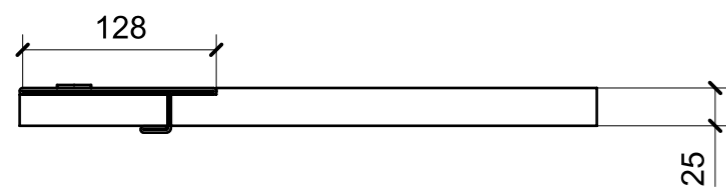
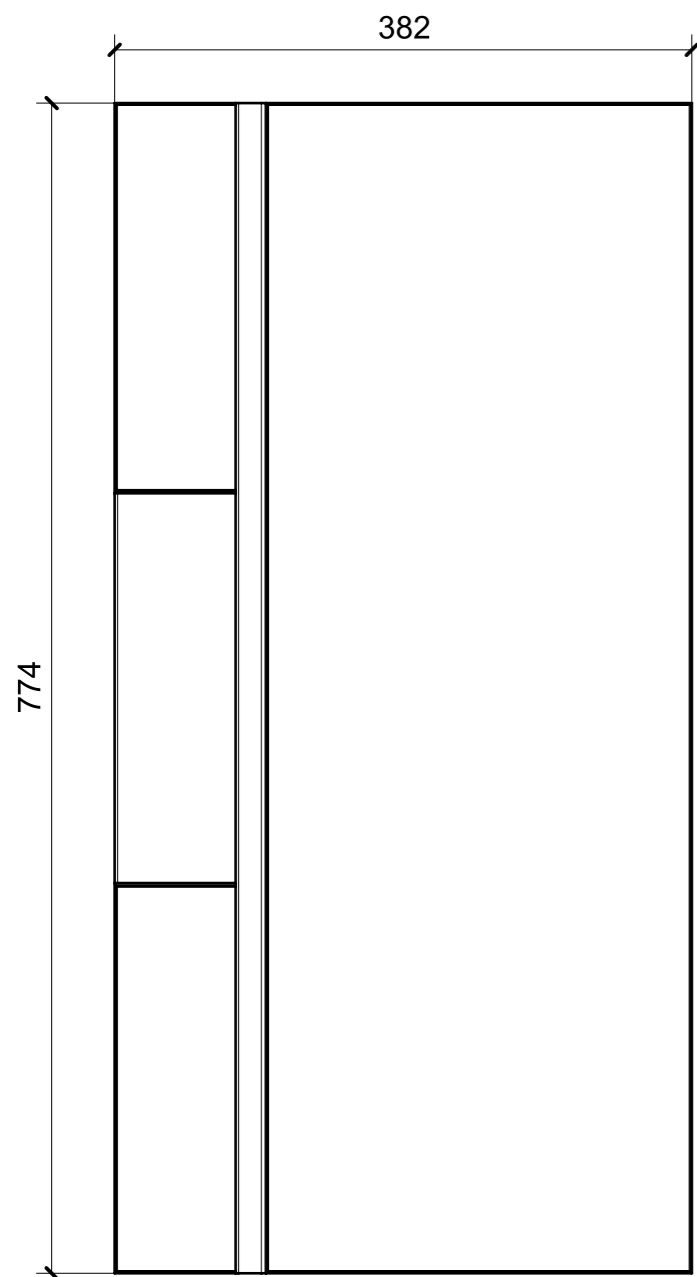

ELEMENTI DA MONTARE  
in MF\_JN01  
e spedire con unico imballo

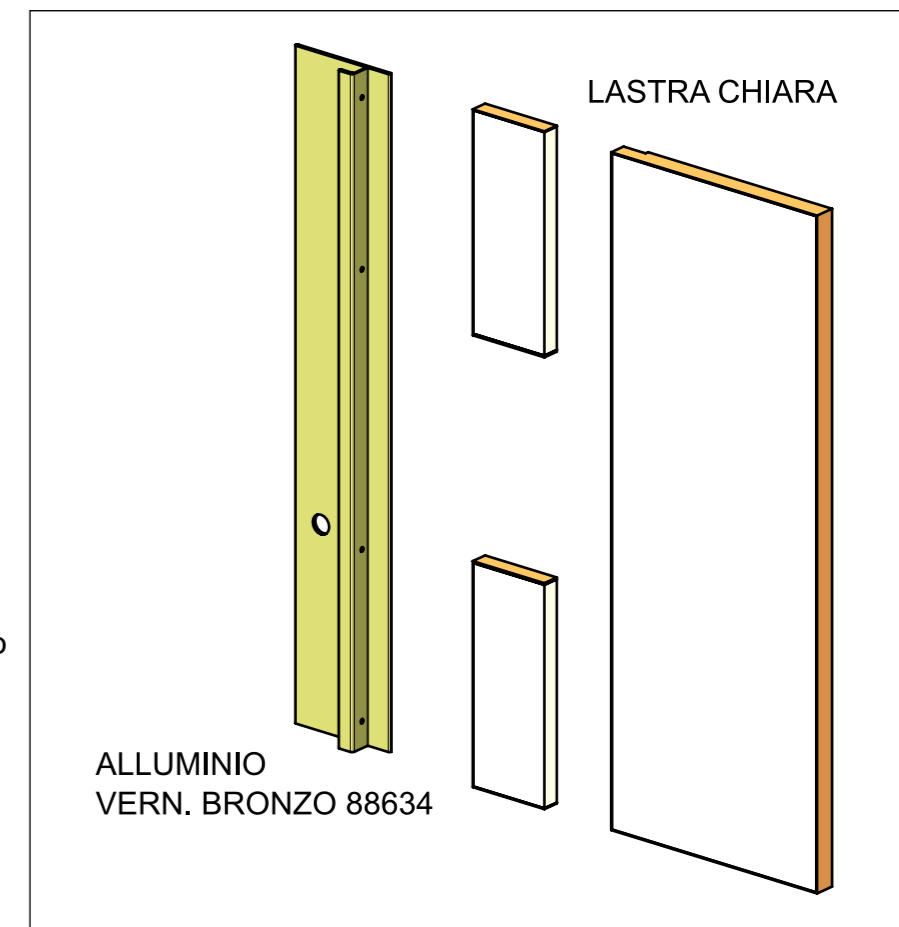
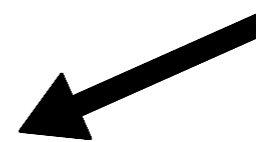

FERRAMENTA	QTY
MAGNETE FORZA MAGNETICA1-5 10KG_HAFELE_246.87.112	1