

LOCALE	CODICE	DESCRIZIONE COMPONENTE	FINITURA	GR.
PORTE	MD321_R01_P04	PORTA BAGNO VIP DX	LASTRA SCURA	PTP

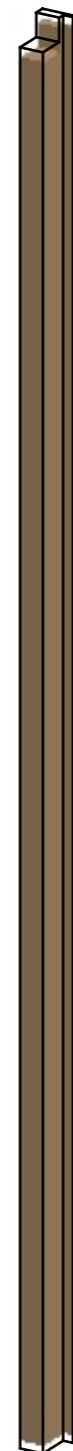
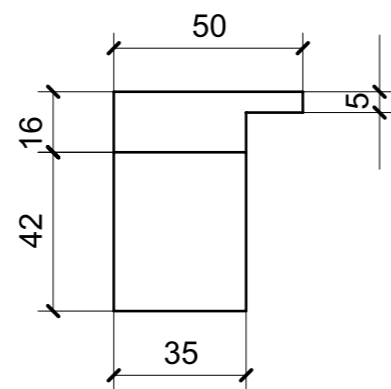
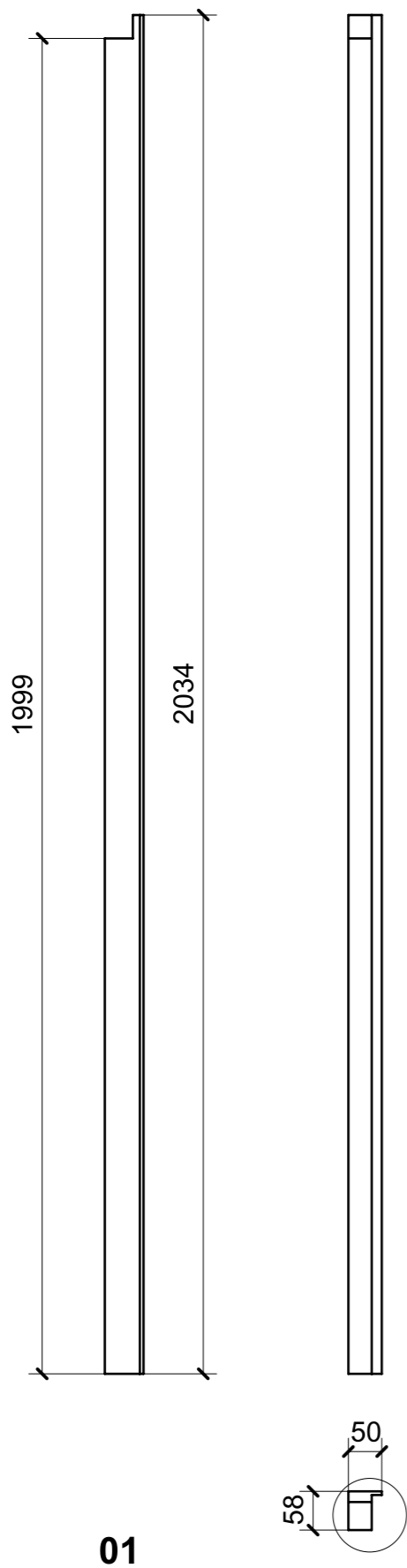

ELEMENTO DA MONTARE  
in MF\_P04  
e spedire con unico imballo

VERNICIATURA LASTRA/LACCATI:

● = VERNICIARE 1 LATO + FILI RASATI O BORDATI

NESSUN SIMBOLO = VERNICIARE 2 LATI + FILI RASATI O BORDATI

LOCALE	CODICE	DESCRIZIONE COMPONENTE	FINITURA	GR.
PORTE	MD321_R02_P04	PORTA BAGNO VIP DX	LASTRA CHIARA	PTP

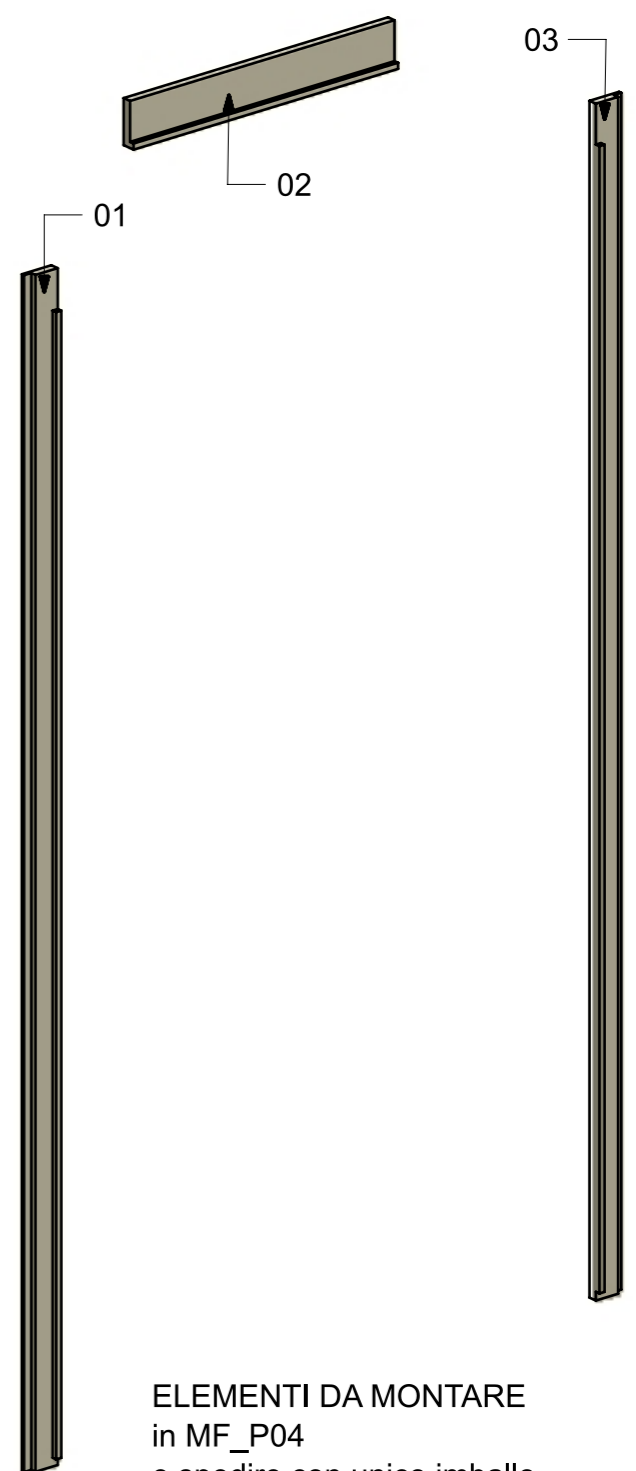
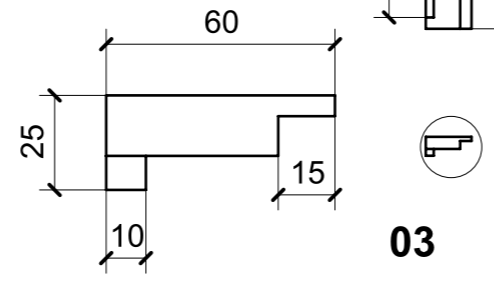
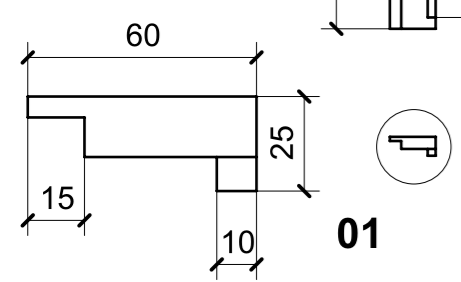
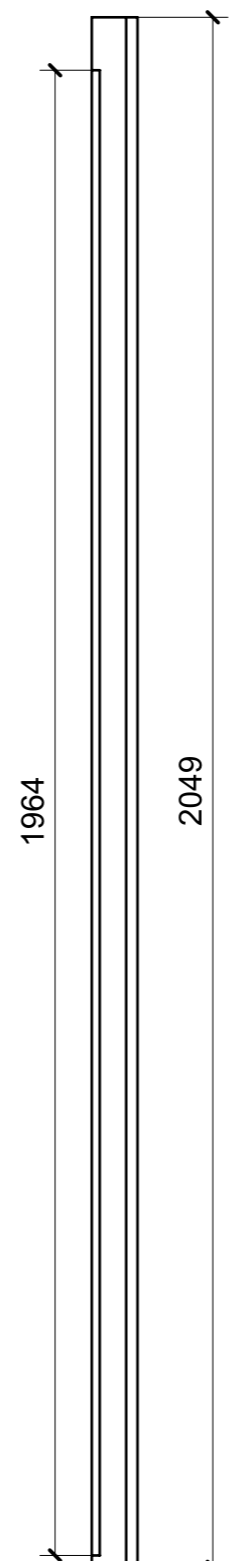
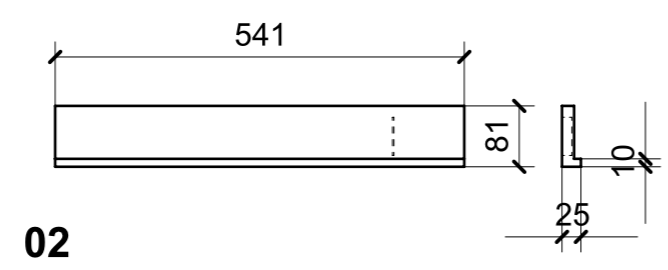
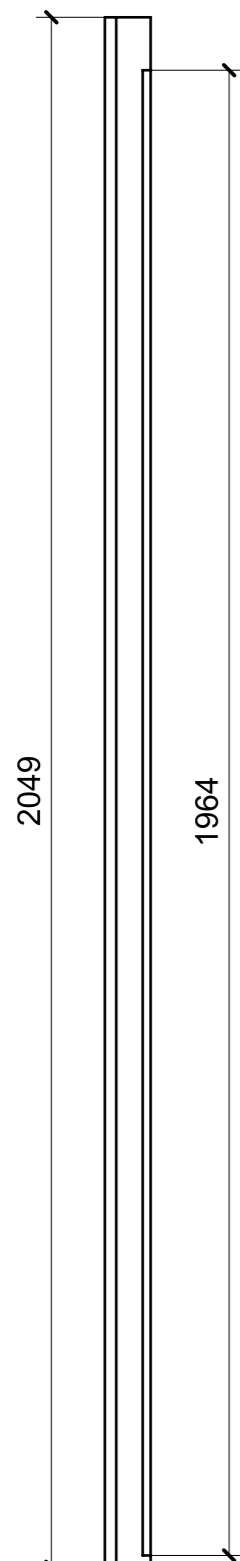

ELEMENTI DA MONTARE  
in MF\_P04  
e spedire con unico imballo

VERNICIATURA LASTRA/LACCATI:  
● = VERNICIARE 1 LATO + FILI RASATI O BORDATI      NESSUN SIMBOLO = VERNICIARE 2 LATI + FILI RASATI O BORDATI

LOCALE	CODICE	DESCRIZIONE COMPONENTE	FINITURA	GR.
PORTE	MD321_R00_P04	PORTA BAGNO VIP DX	LASTRA CHIARA E SCURA	PTP

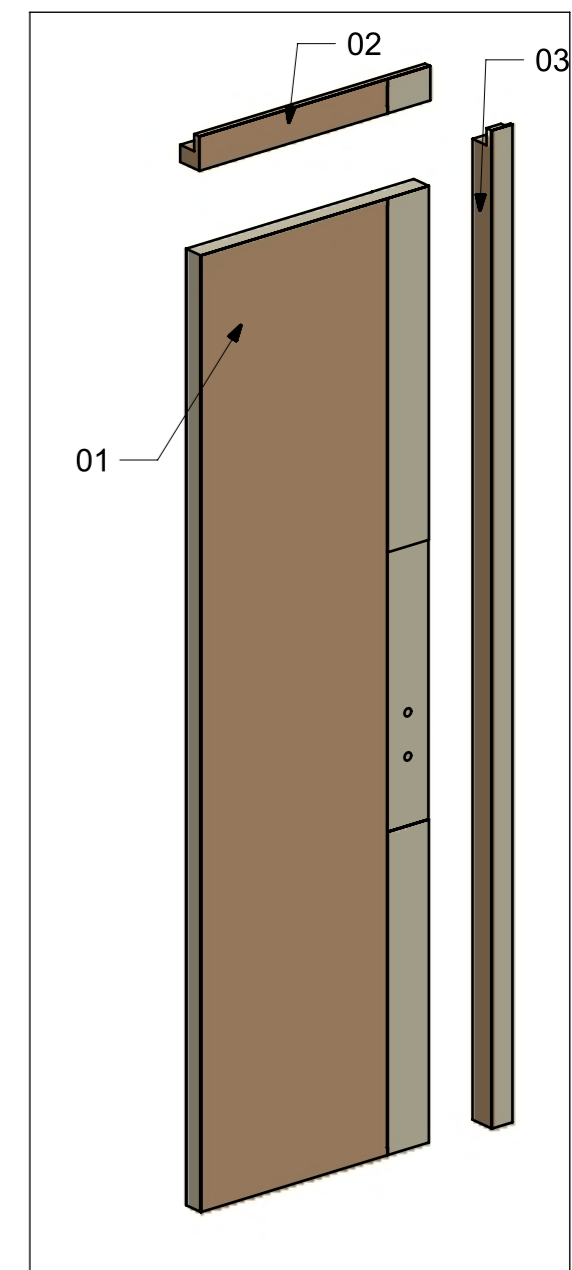
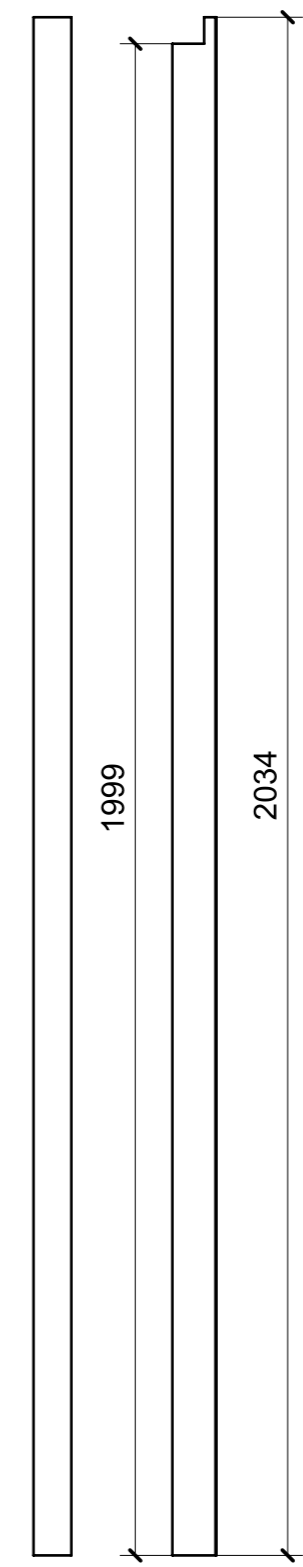
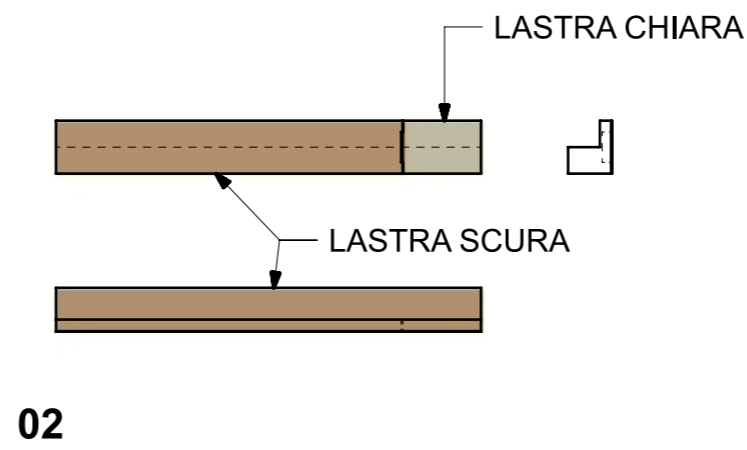
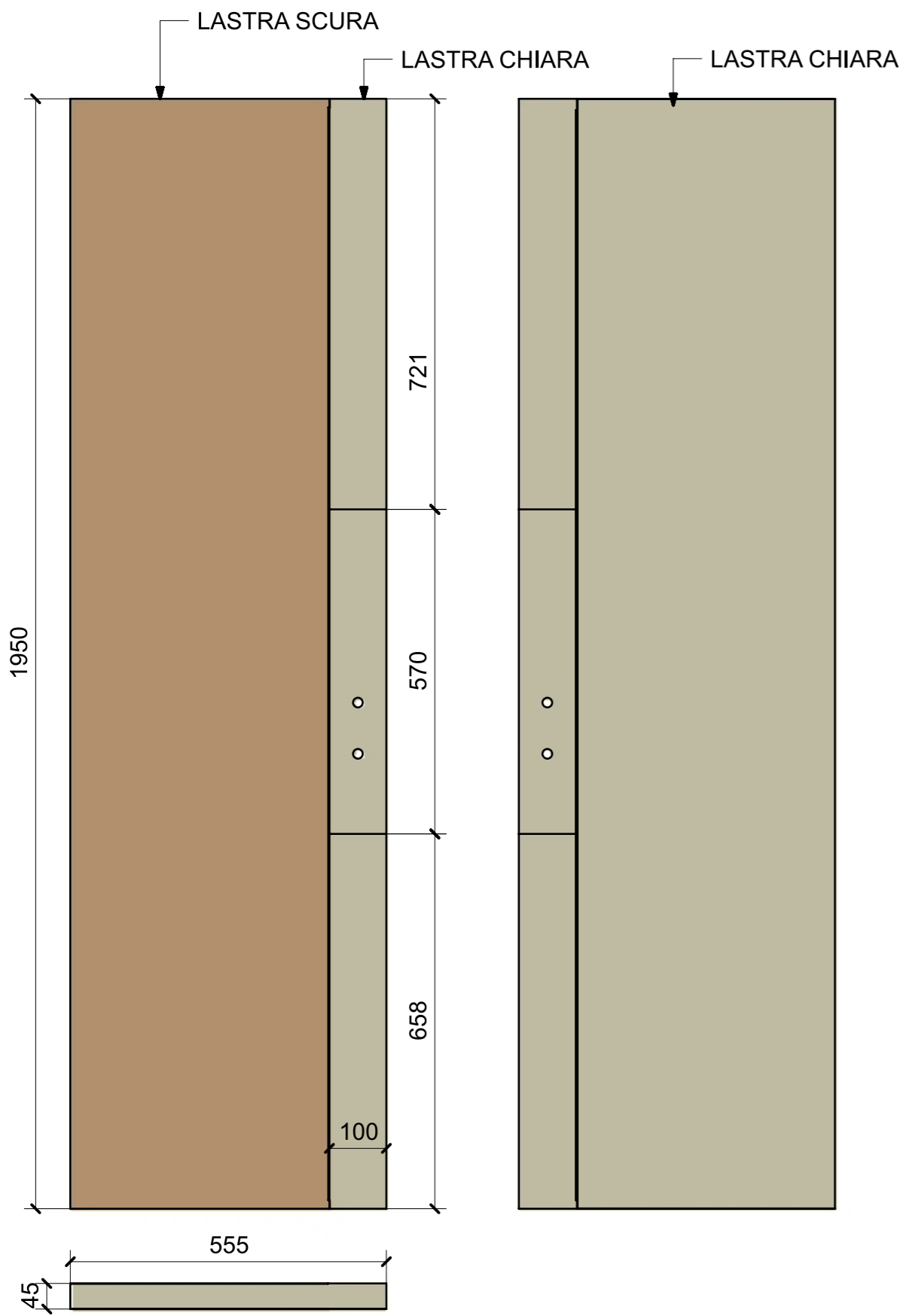

ELEMENTI DA MONTARE  
in MF\_P04  
e spedire con unico imballo

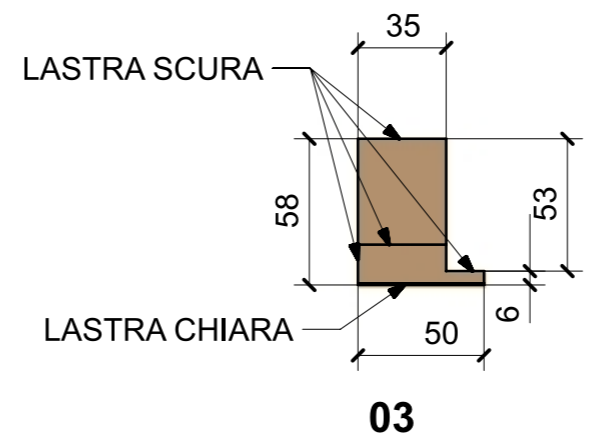

01

03

LOCALE	CODICE	DESCRIZIONE COMPONENTE	FINITURA	GR.
PORTE	MD321_R01_P05	PORTA BAGNO VIP SX	LASTRA SCURA	PTP

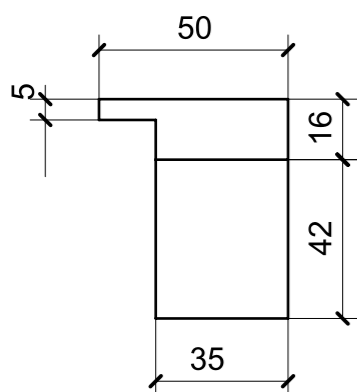

01

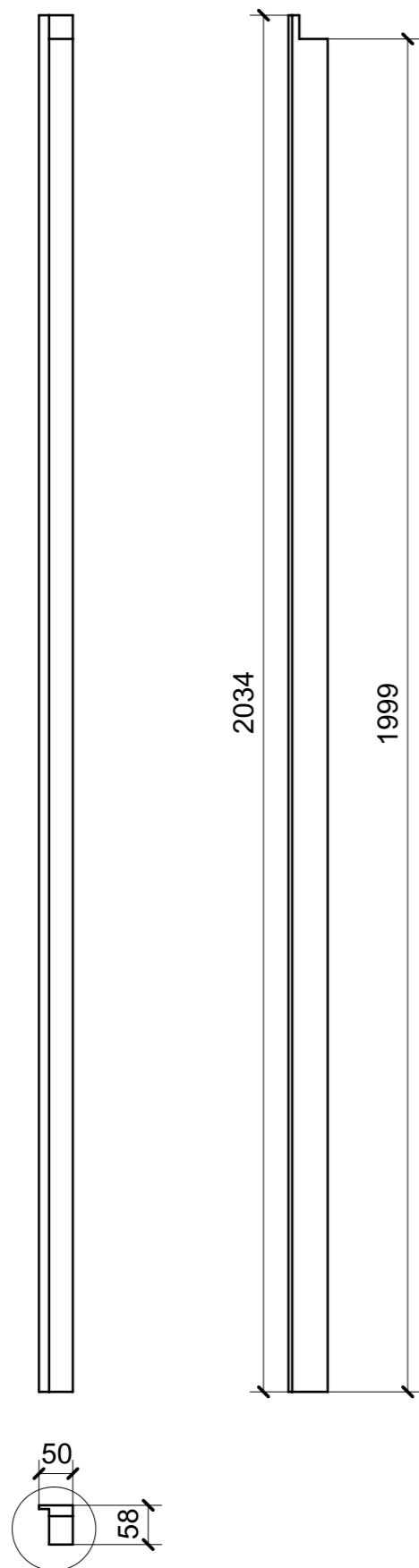

ELEMENTO DA MONTARE  
in MF\_P05  
e spedire con unico imballo

VERNICIATURA LASTRA/LACCATI:

● = VERNICIARE 1 LATO + FILI RASATI O BORDATI

NESSUN SIMBOLO = VERNICIARE 2 LATI + FILI RASATI O BORDATI

LOCALE	CODICE	DESCRIZIONE COMPONENTE	FINITURA	GR.
PORTE	MD321_R02_P05	PORTA BAGNO VIP SX	LASTRA CHIARA	PTP



01

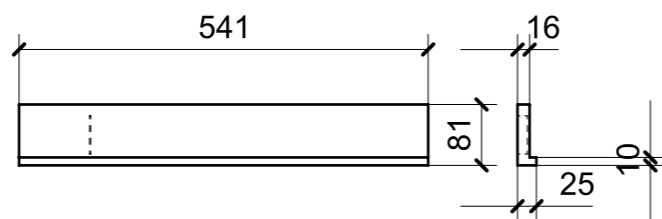
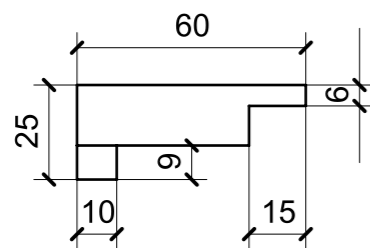

02

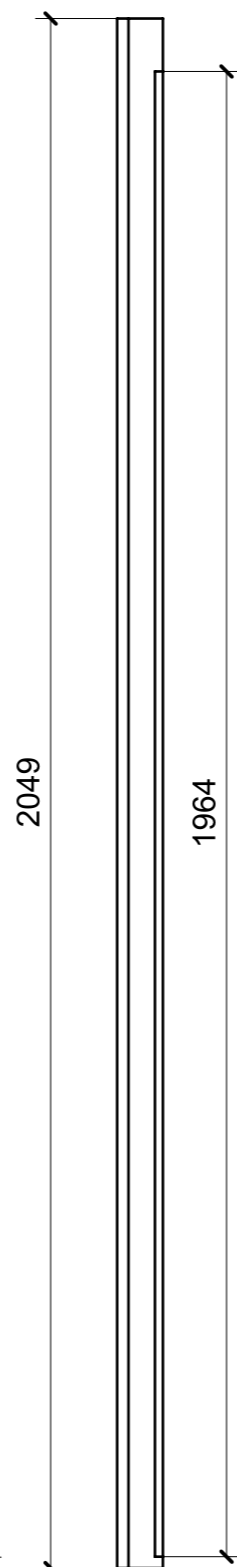

03

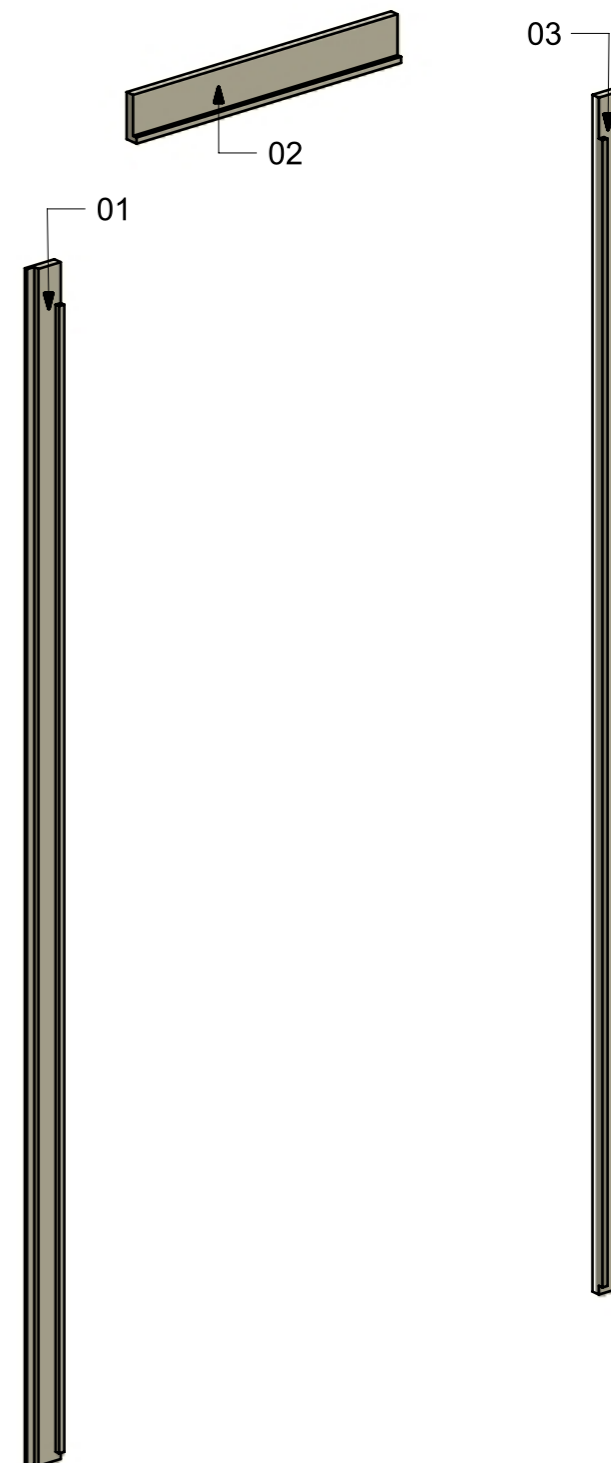
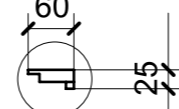
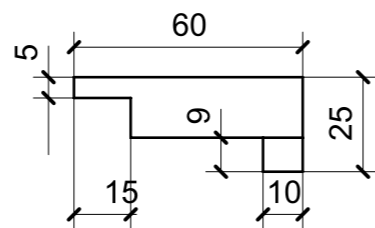

ELEMENTI DA MONTARE  
in MF\_P05  
e spedire con unico imballo

VERNICIATURA LASTRA/LACCATI:

● = VERNICIARE 1 LATO + FILI RASATI O BORDATI

NESSUN SIMBOLO = VERNICIARE 2 LATI + FILI RASATI O BORDATI

LOCALE	CODICE	DESCRIZIONE COMPONENTE	FINITURA	GR.
PORTE	MD321_R00_P05	PORTA BAGNO VIP SX	LASTRA CHIARA E SCURA	PTP

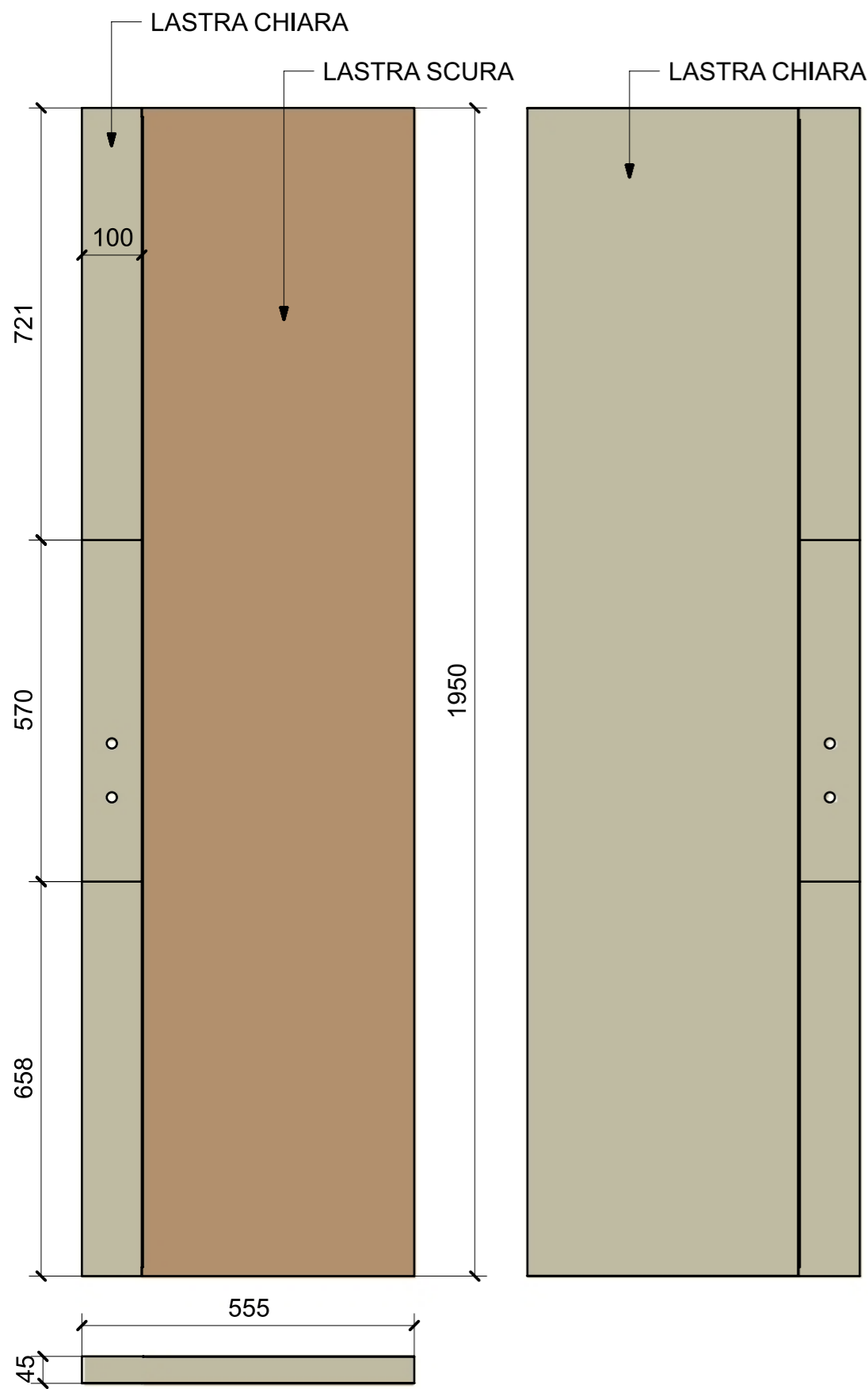

01

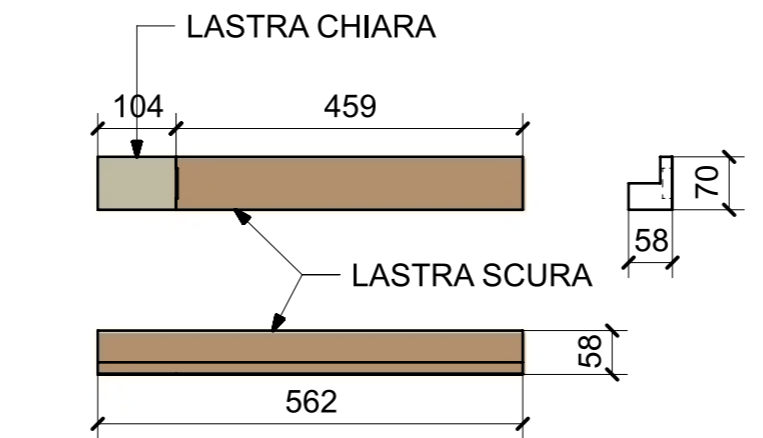

02

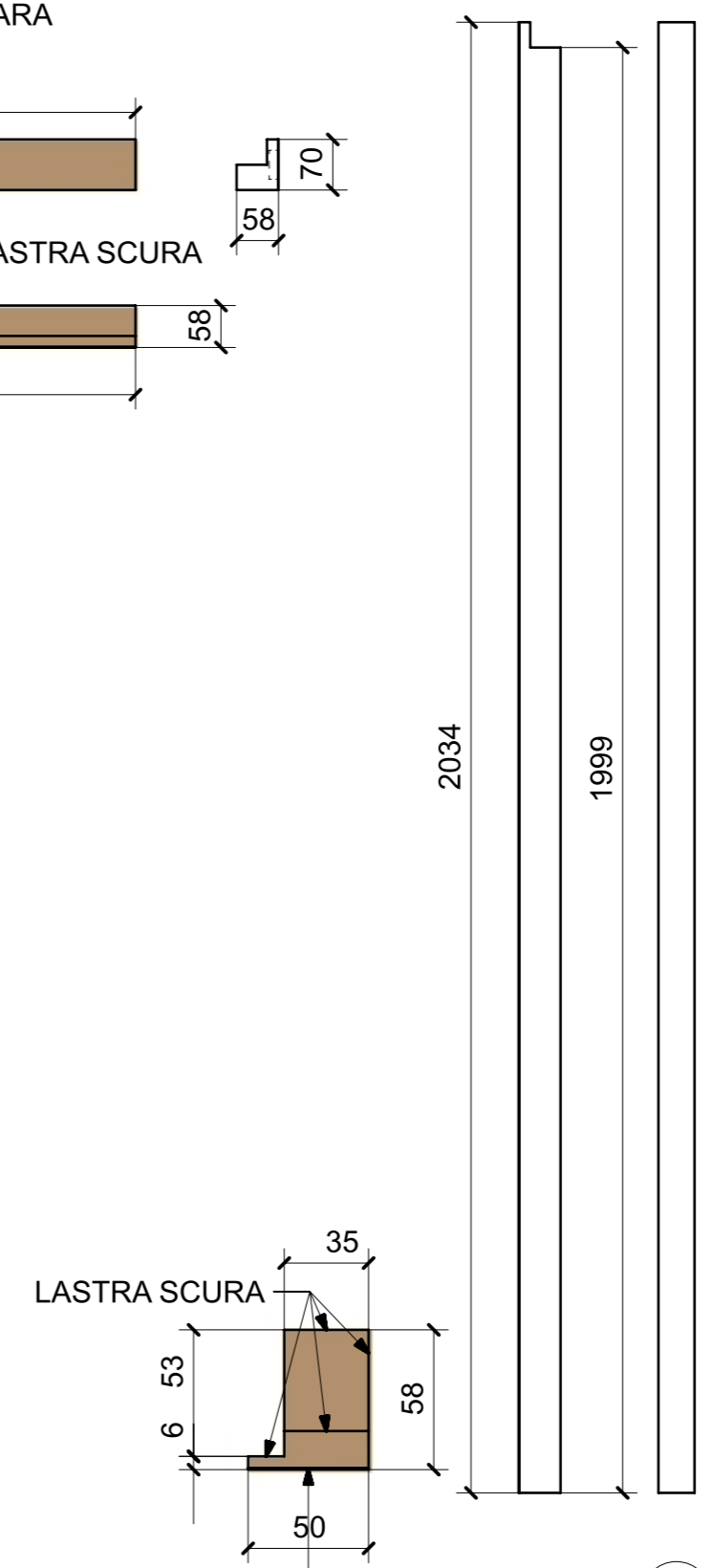

03

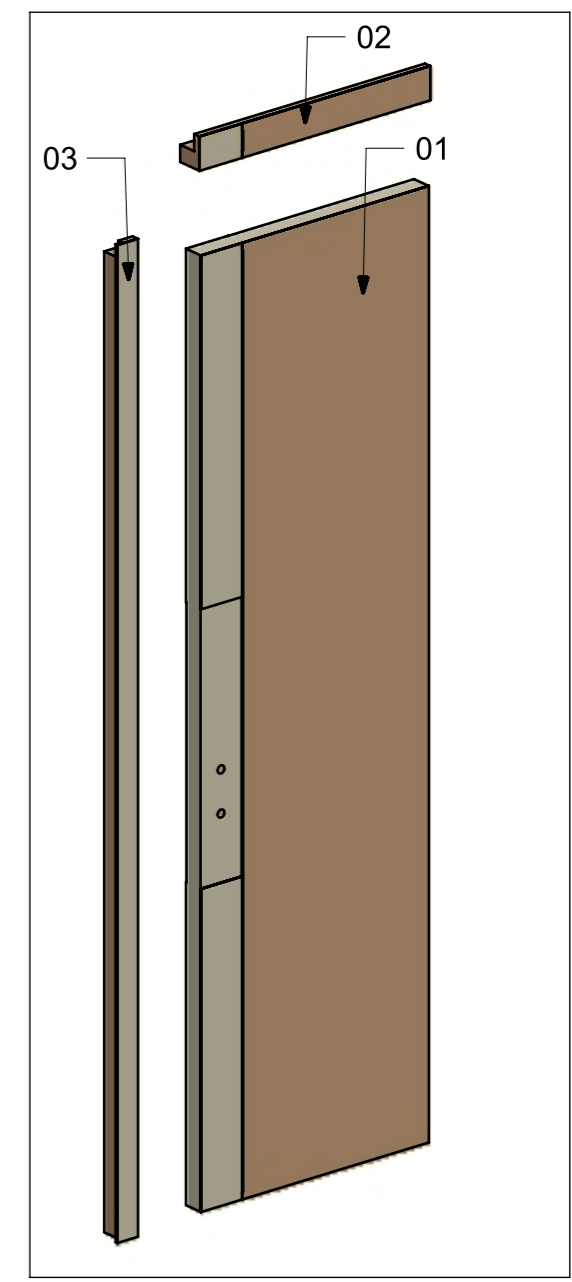

ELEMENTI DA MONTARE  
in MF\_P05  
e spedire con unico imballo

LOCALE	CODICE	DESCRIZIONE COMPONENTE	FINITURA	GR.
PORTE	MD321_R01_P06	PORTA CABINA VIP DX	LASTRA SCURA	PTP

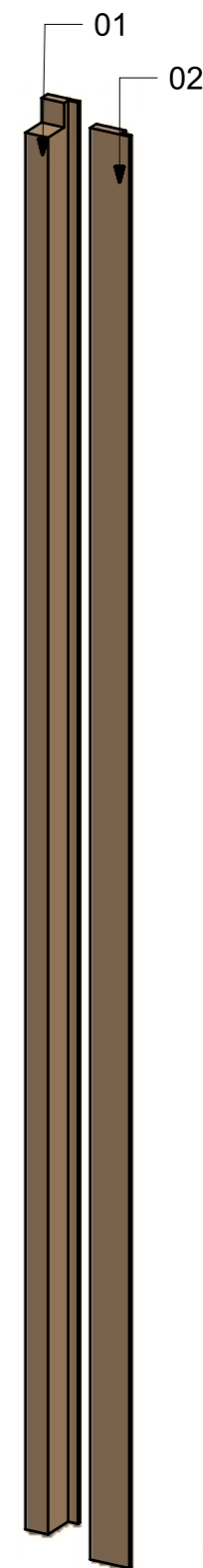
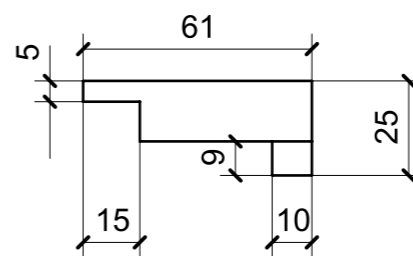
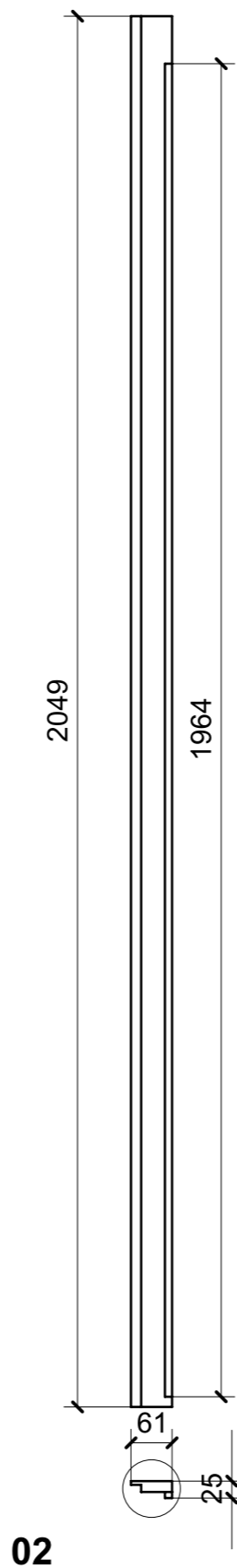
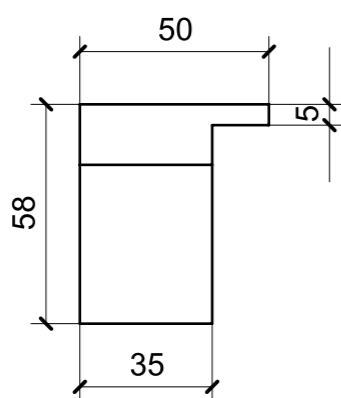
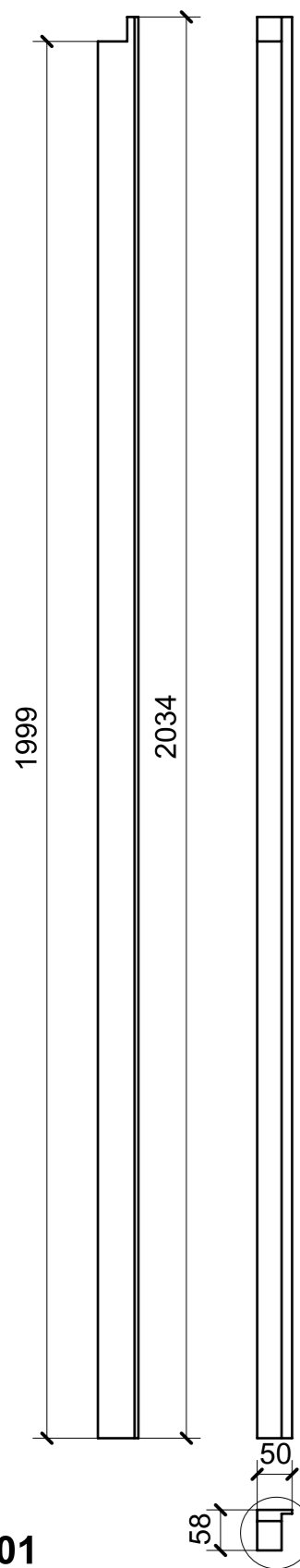

ELEMENTI DA MONTARE  
in MF\_P06  
e spedire con unico imballo

VERNICIATURA LASTRA/LACCATI:

● = VERNICIARE 1 LATO + FILI RASATI O BORDATI

NESSUN SIMBOLO = VERNICIARE 2 LATI + FILI RASATI O BORDATI

LOCALE	CODICE	DESCRIZIONE COMPONENTE	FINITURA	GR.
PORTE	MD321_R02_P06	PORTA CABINA VIP DX	LASTRA CHIARA	PTP

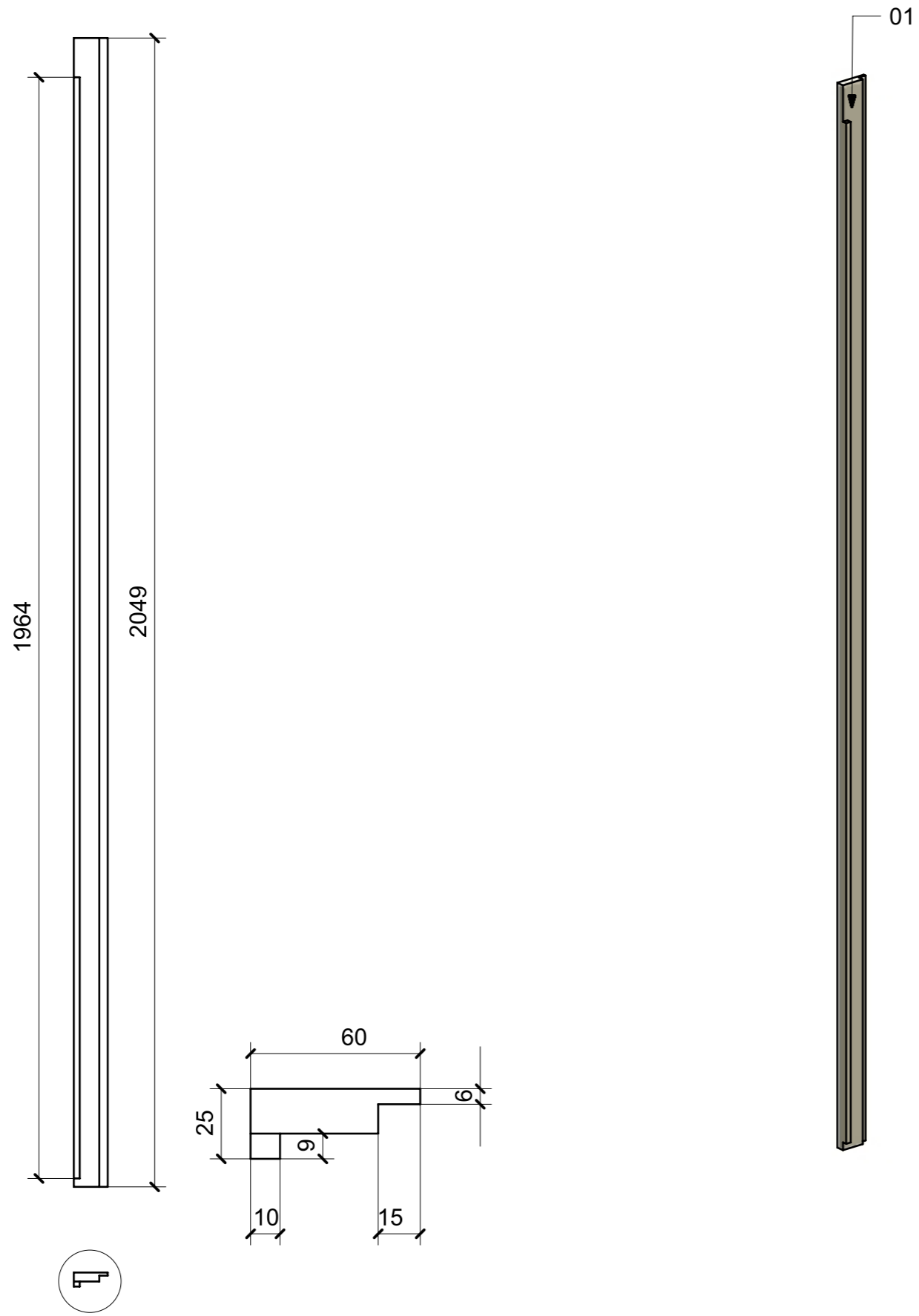

ELEMENTO DA MONTARE  
in MF\_P06  
e spedire con unico imballo

01

VERNICIATURA LASTRA/LACCATI:  
● = VERNICIARE 1 LATO + FILI RASATI O BORDATI      NESSUN SIMBOLO = VERNICIARE 2 LATI + FILI RASATI O BORDATI

LOCALE	CODICE	DESCRIZIONE COMPONENTE	FINITURA	GR.
PORTE	MD321_R00_P06	PORTA CABINA VIP DX	LASTRA CHIARA E SCURA	PTP

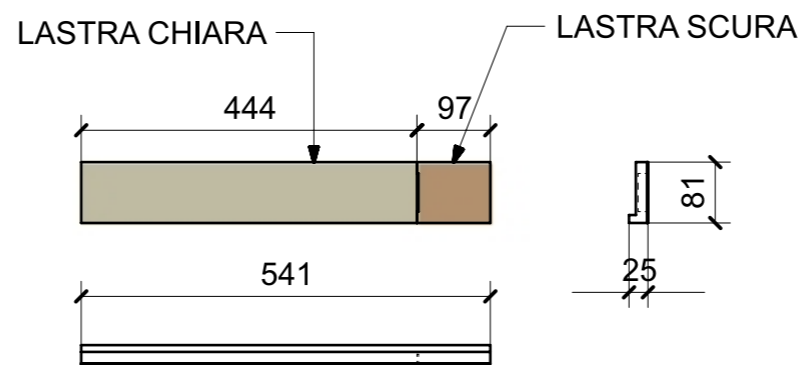
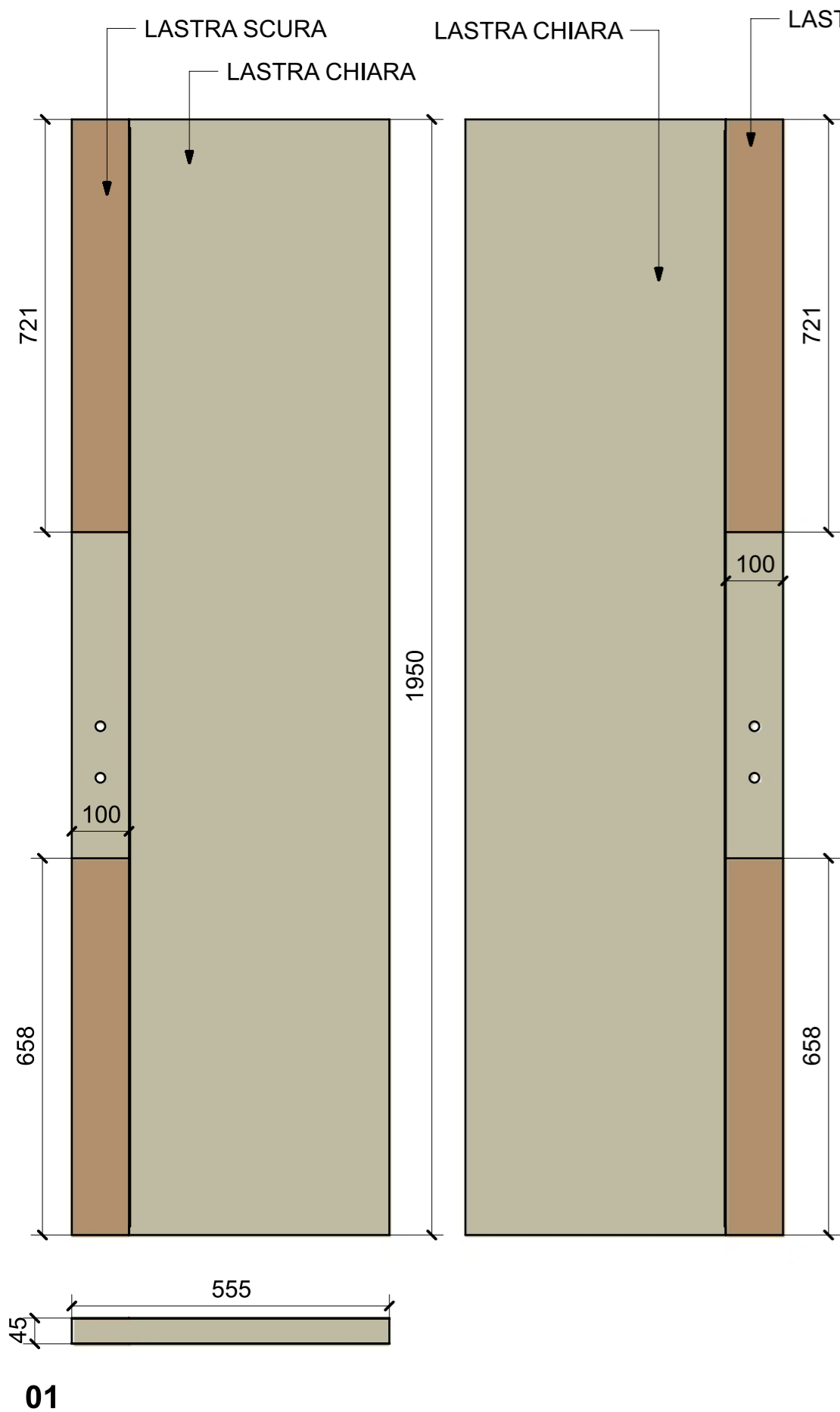

**02**

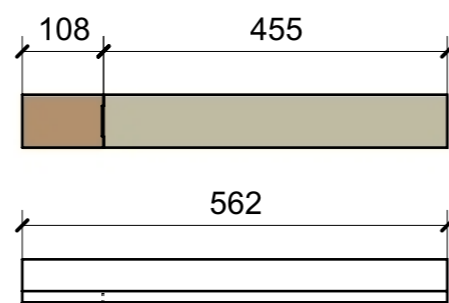

**03**

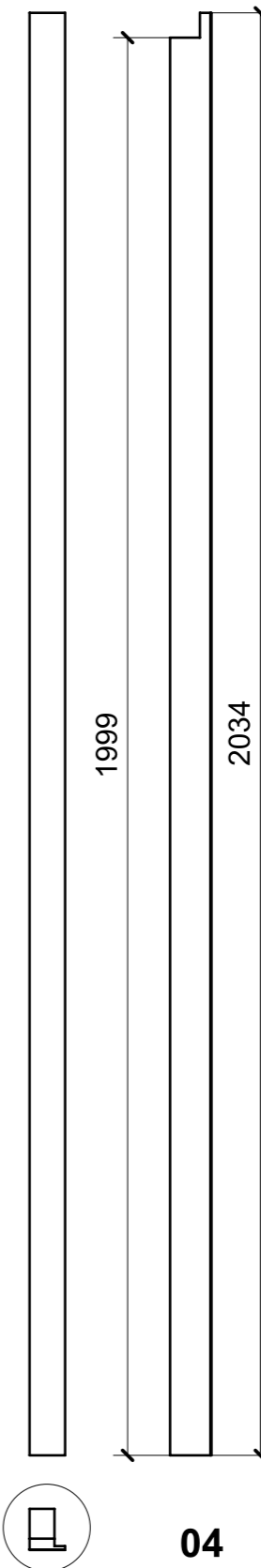

**04**

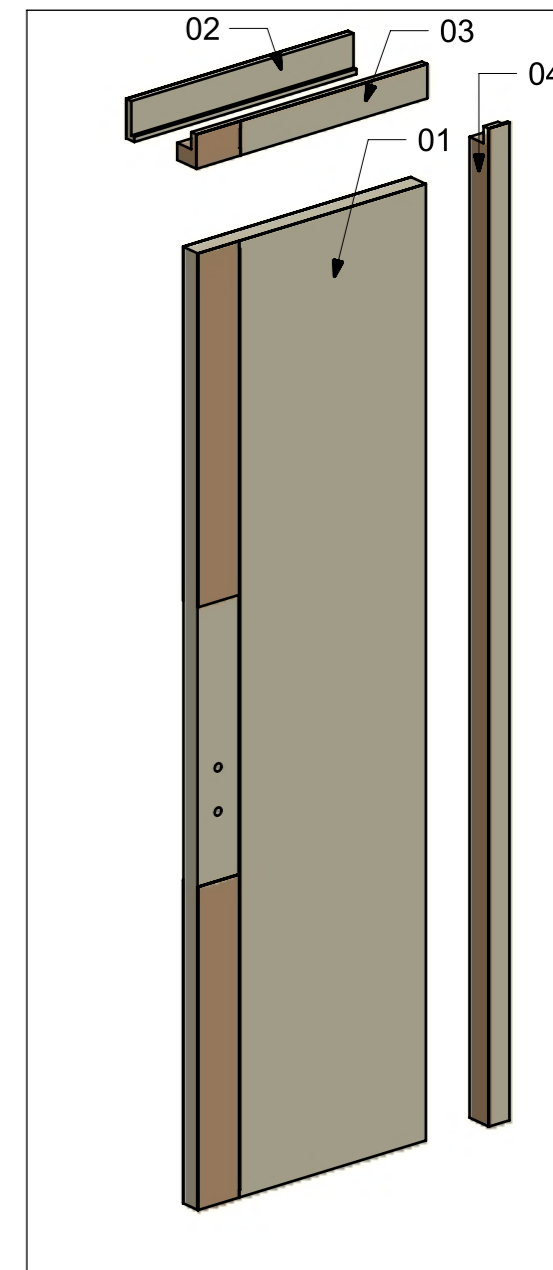

ELEMENTI DA MONTARE  
in MF\_P06  
e spedire con unico imballo

VERNICIATURA LASTRA/LACCATI: ● = VERNICIARE 1 LATO + FILI RASATI O BORDATI

NESSUN SIMBOLO = VERNICIARE 2 LATI + FILI RASATI O BORDATI

LOCALE	CODICE	DESCRIZIONE COMPONENTE	FINITURA	GR.
PORTE	MD321_R01_P07	PORTA CABINA VIP SX	LASTRA SCURA	PTP

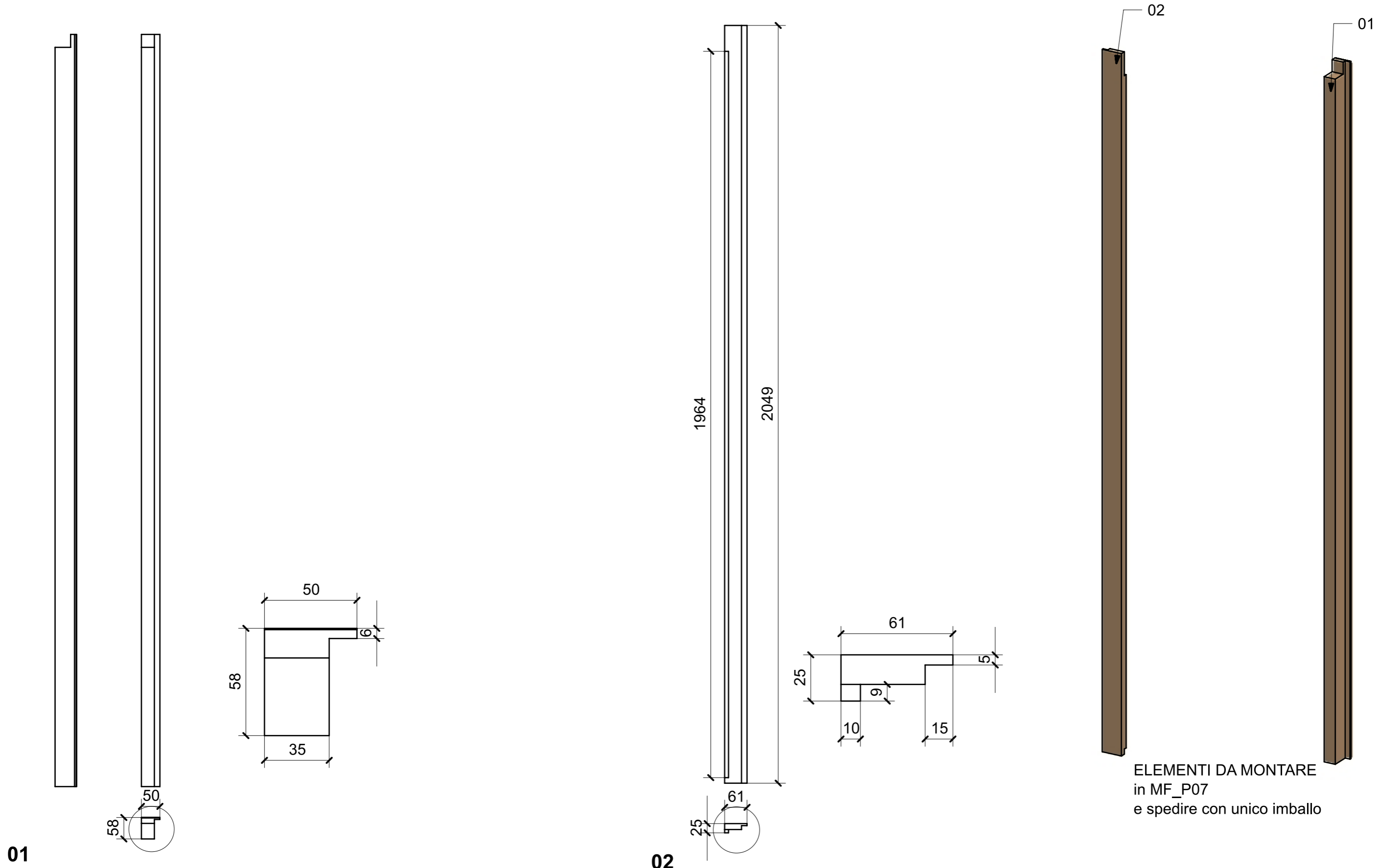

ELEMENTI DA MONTARE  
in MF\_P07  
e spedire con unico imballo

VERNICIATURA LASTRA/LACCATI:

● = VERNICIARE 1 LATO + FILI RASATI O BORDATI

NESSUN SIMBOLO = VERNICIARE 2 LATI + FILI RASATI O BORDATI

LOCALE	CODICE	DESCRIZIONE COMPONENTE	FINITURA	GR.
PORTE	MD321_R02_P07	PORTA CABINA VIP SX	LASTRA CHIARA	PTP

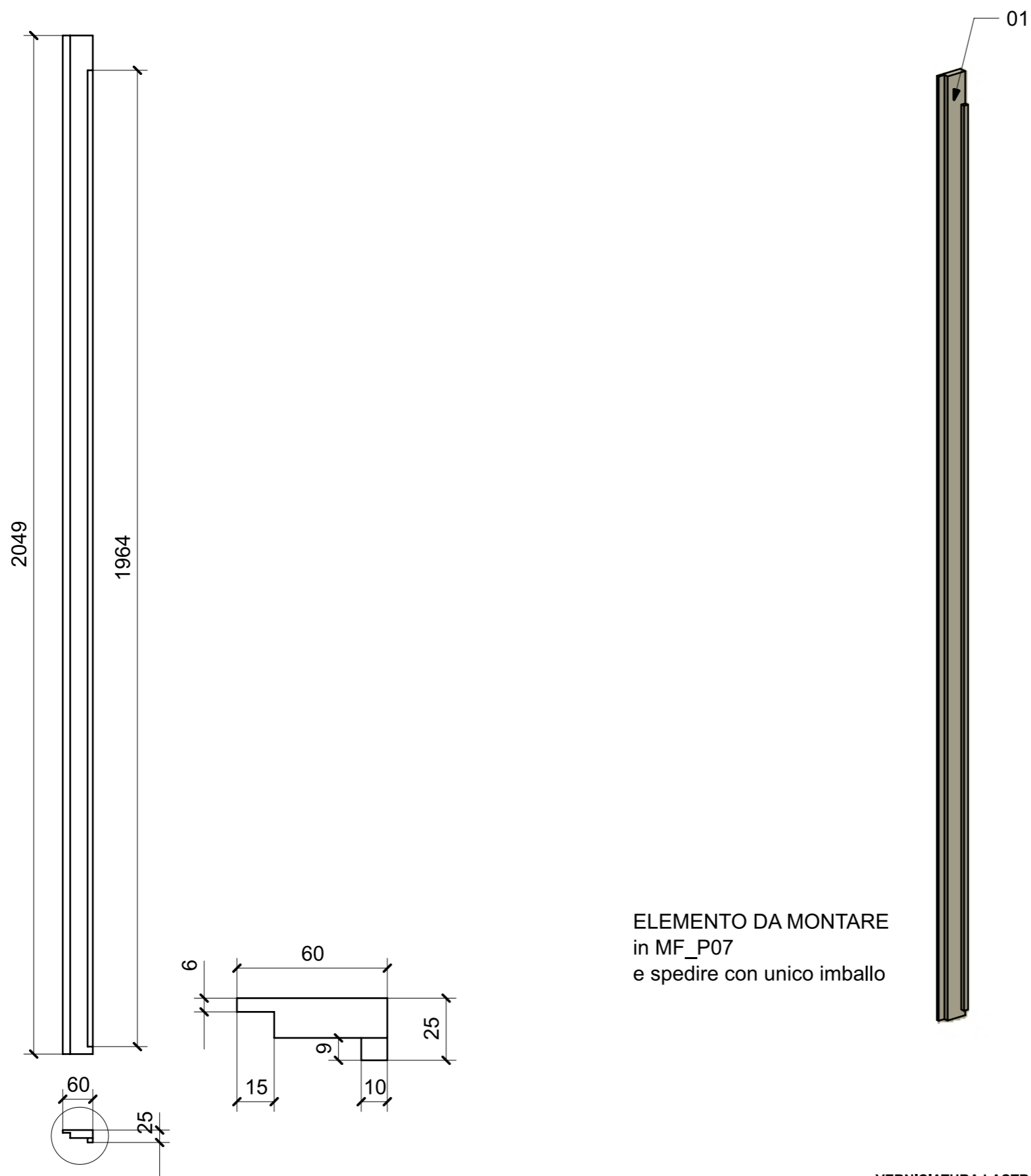

ELEMENTO DA MONTARE  
in MF\_P07  
e spedire con unico imballo

01

VERNICIATURA LASTRA/LACCATI:

● = VERNICIARE 1 LATO + FILI RASATI O BORDATI

NESSUN SIMBOLO = VERNICIARE 2 LATI + FILI RASATI O BORDATI

LOCALE	CODICE	DESCRIZIONE COMPONENTE	FINITURA	GR.
PORTE	MD321_R00_P07	PORTA CABINA VIP SX	LASTRA CHIARA E SCURA	PTP

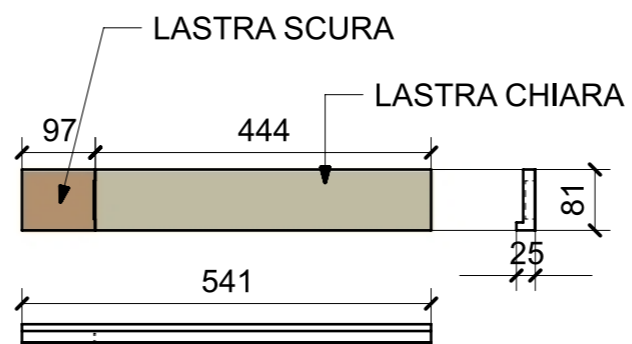
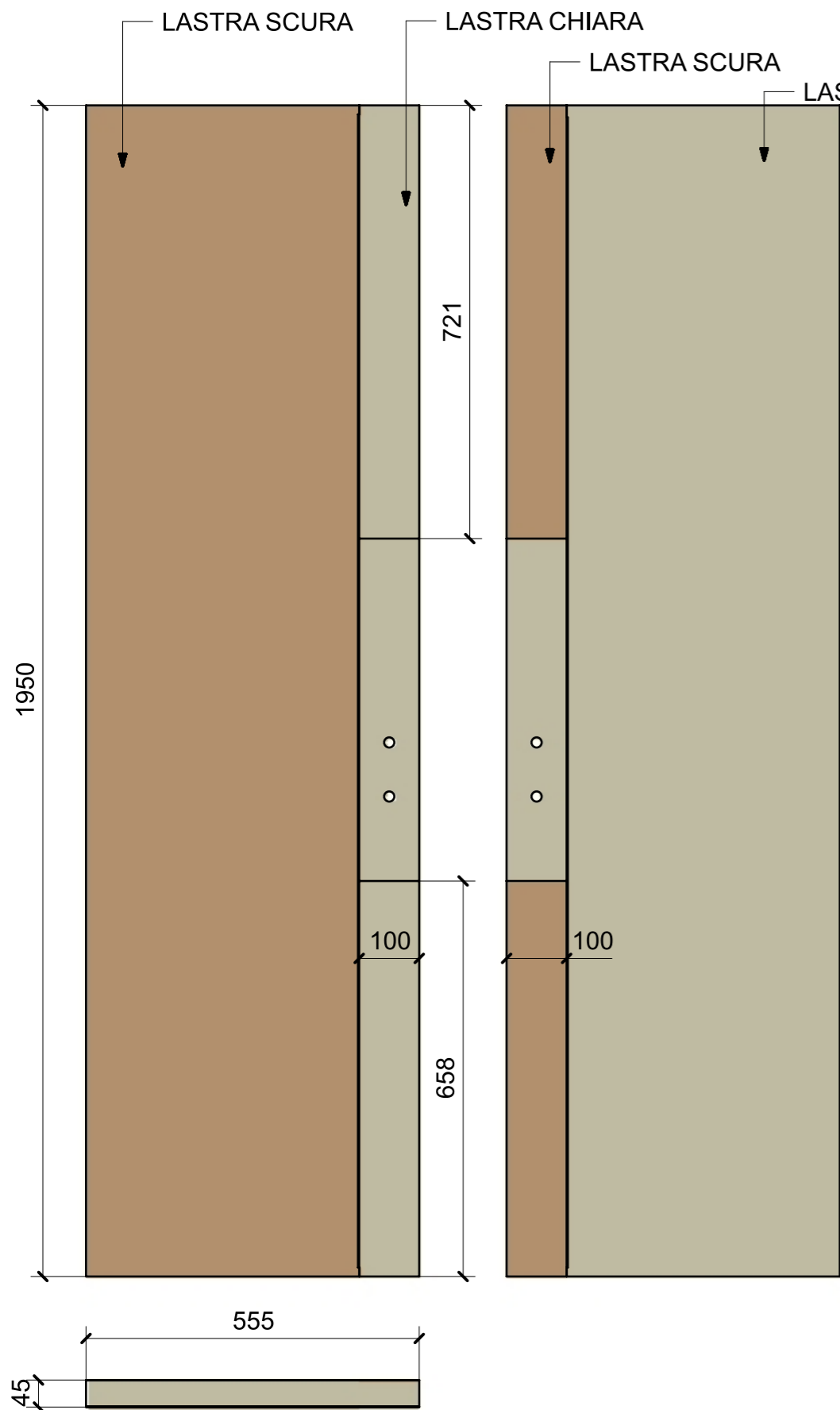

**02**

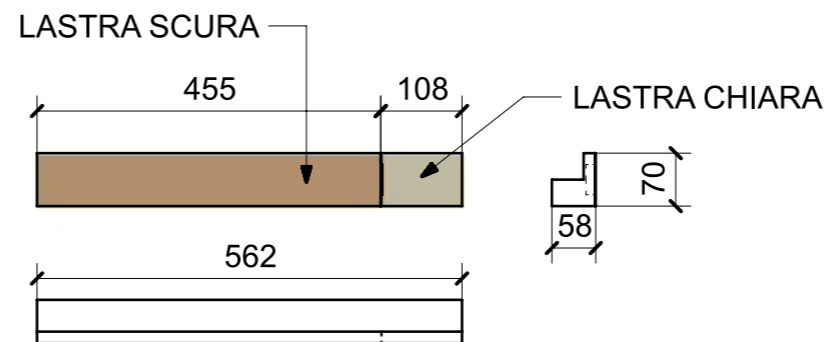

**03**

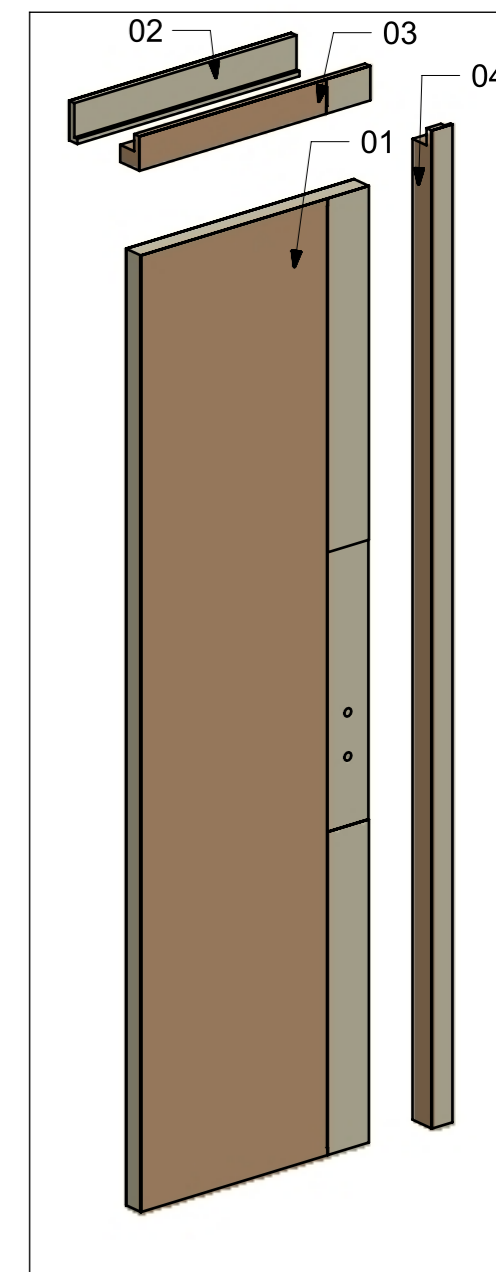
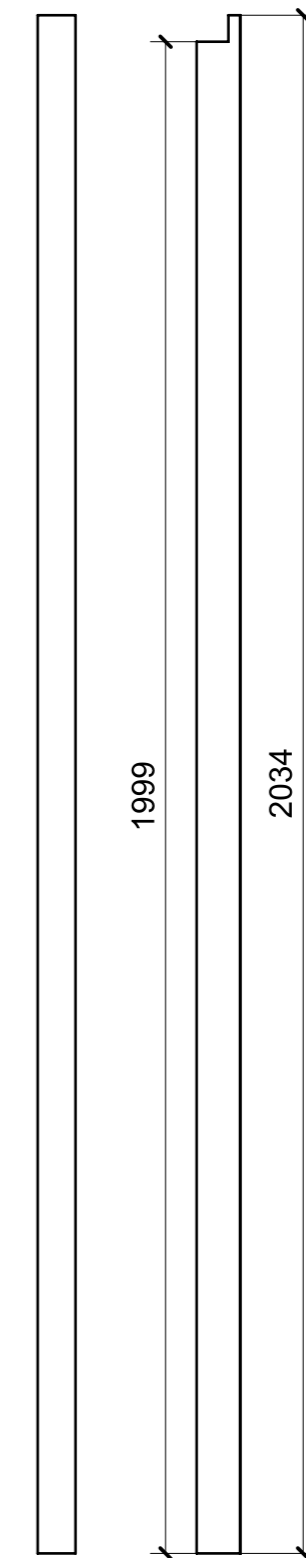
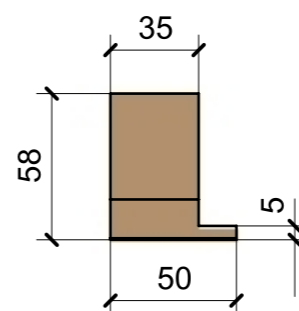

ELEMENTI DA MONTARE  
in MF\_P07  
e spedire con unico imballo

**01**

**04**

VERNICIATURA LASTRA/LACCATI: ● = VERNICIARE 1 LATO + FILI RASATI O BORDATI

NESSUN SIMBOLO = VERNICIARE 2 LATI + FILI RASATI O BORDATI

LOCALE	CODICE	DESCRIZIONE COMPONENTE	FINITURA	GR.
PORTE	MD321_R01_P08	PORTA CABINA OSPITI DX	LASTRA SCURA	PTP

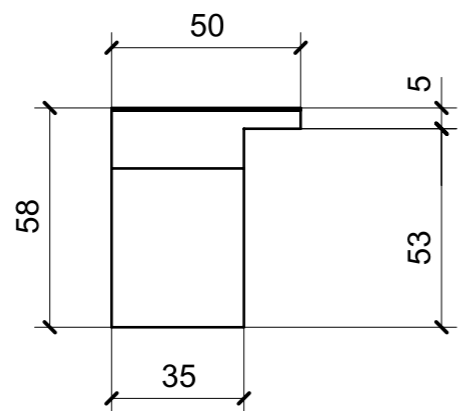
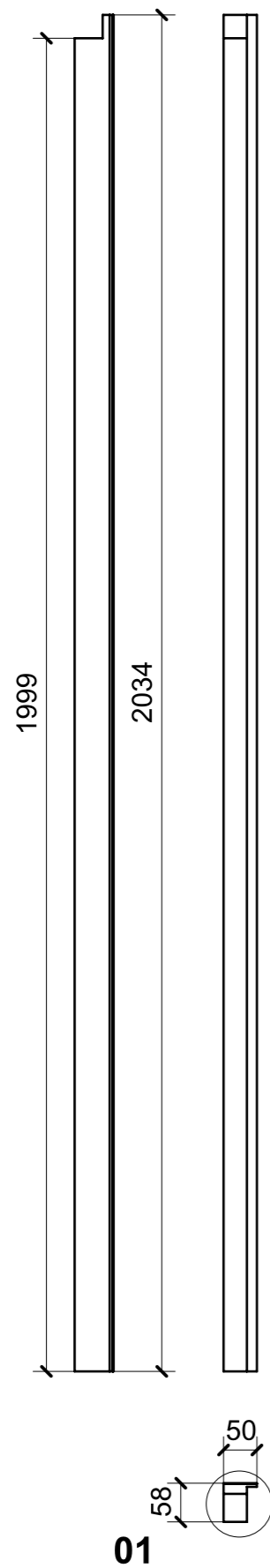

ELEMENTO DA MONTARE  
in MF\_P08  
e spedire con unico imballo

VERNICIATURA LASTRA/LACCATI:

● = VERNICIARE 1 LATO + FILI RASATI O BORDATI

NESSUN SIMBOLO = VERNICIARE 2 LATI + FILI RASATI O BORDATI

LOCALE	CODICE	DESCRIZIONE COMPONENTE	FINITURA	GR.
PORTE	MD321_R02_P08	PORTA CABINA OSPITI DX	LASTRA CHIARA	PTP

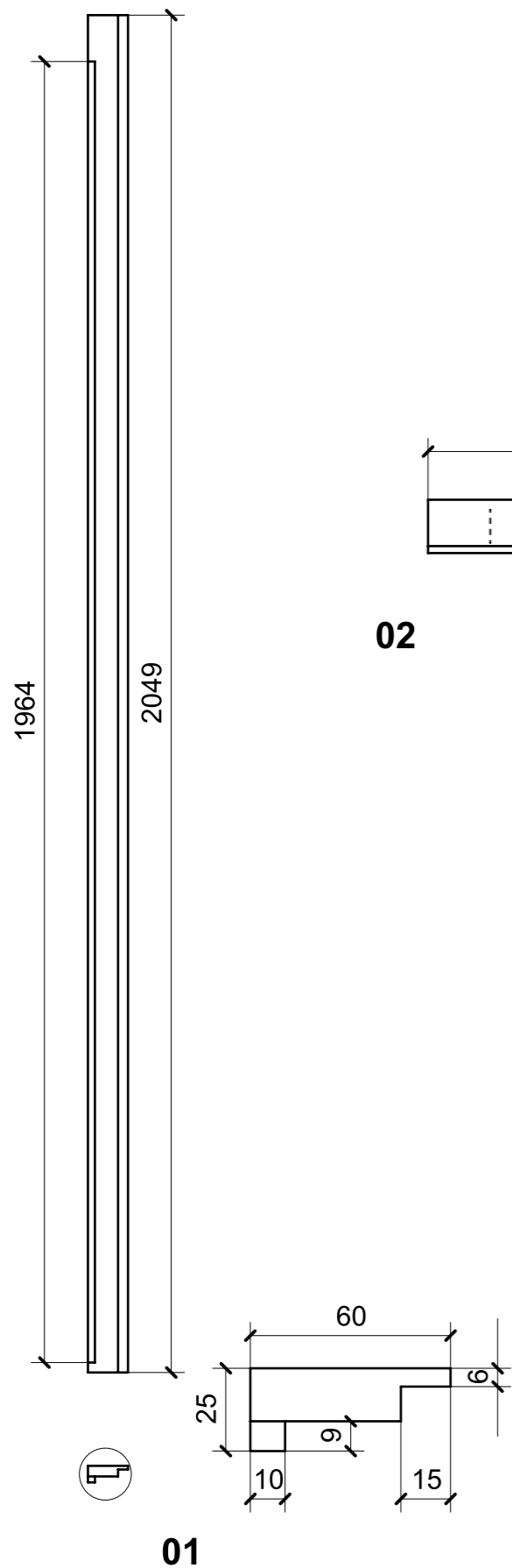

01

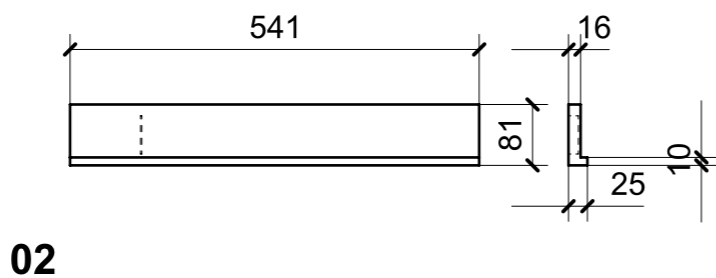

02

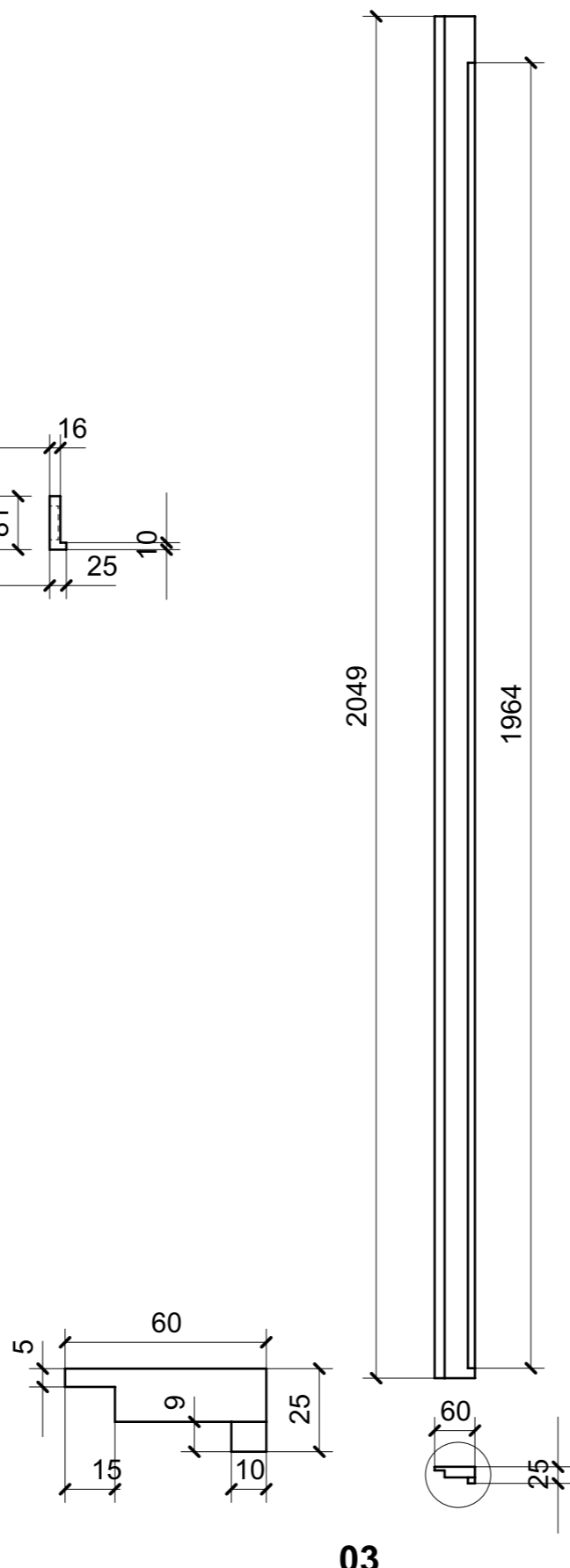

03

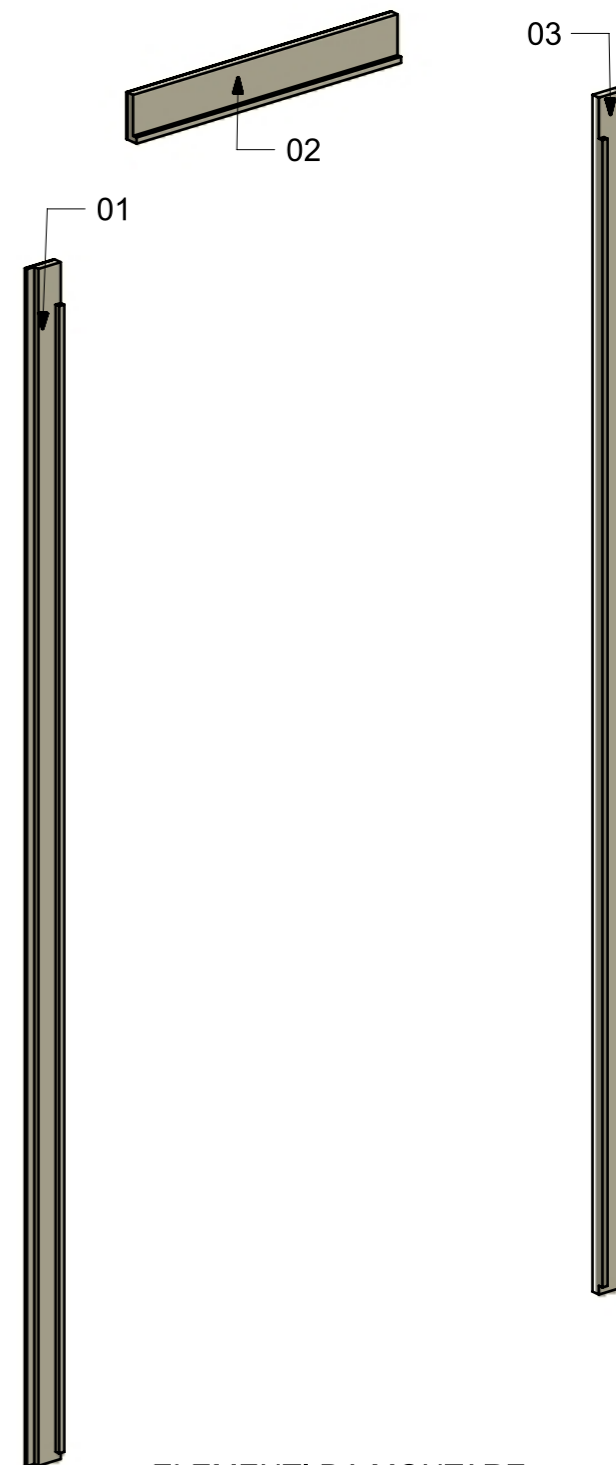

ELEMENTI DA MONTARE  
in MF\_P08  
e spedire con unico imballo

VERNICIATURA LASTRA/LACCATI:

● = VERNICIARE 1 LATO + FILI RASATI O BORDATI

NESSUN SIMBOLO = VERNICIARE 2 LATI + FILI RASATI O BORDATI

LOCALE	CODICE	DESCRIZIONE COMPONENTE	FINITURA	GR.
PORTE	MD321_R00_P08	PORTA CABINA OSPITI DX	LASTRA CHIARA E SCURA	PTP

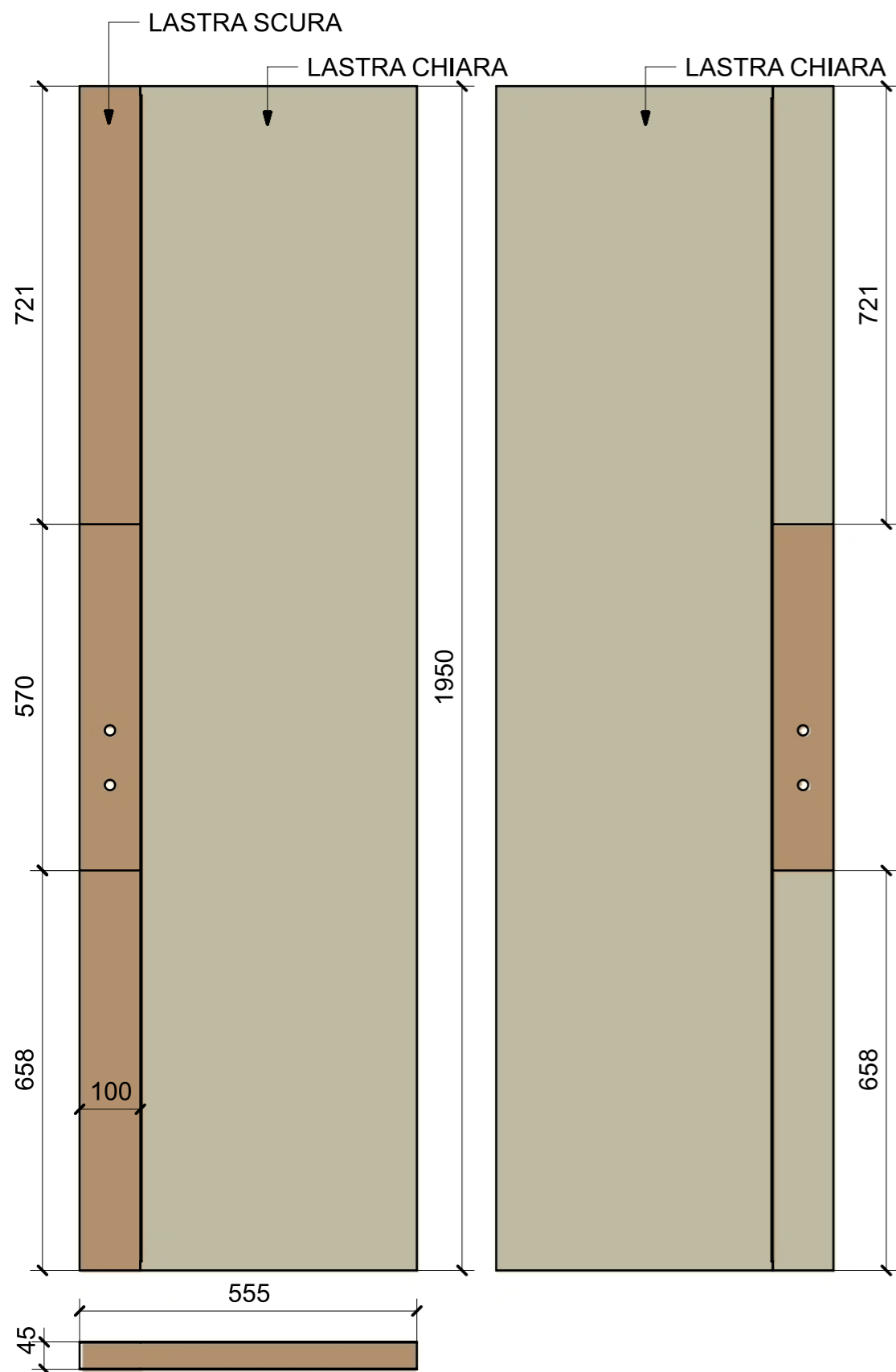

01

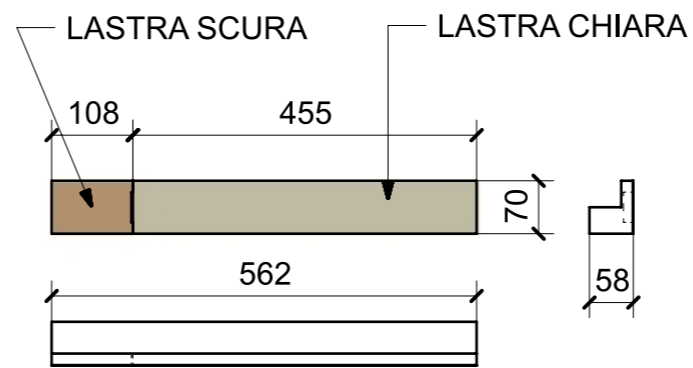

02

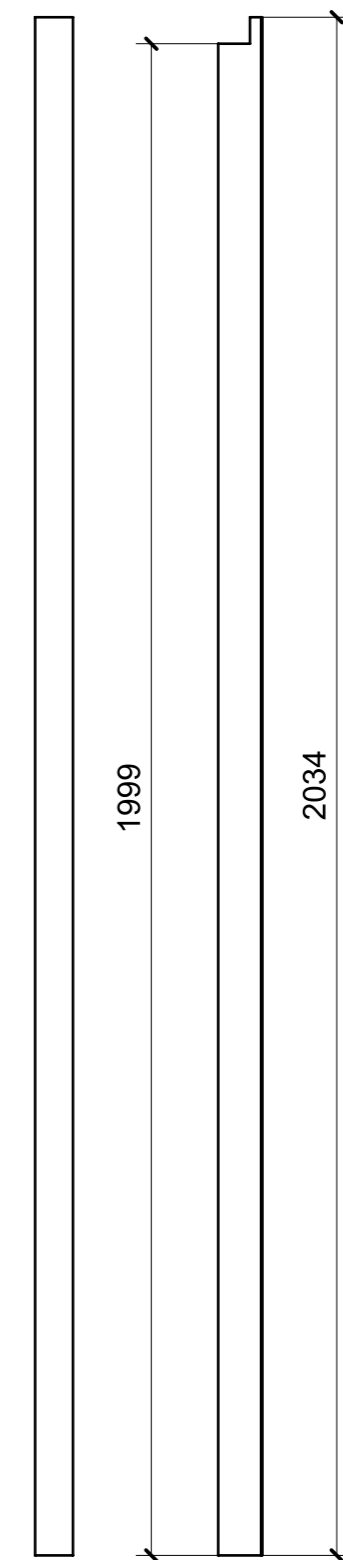
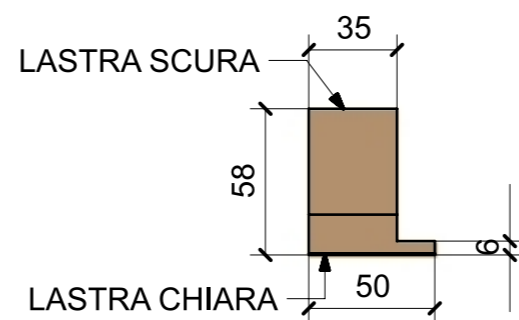

03

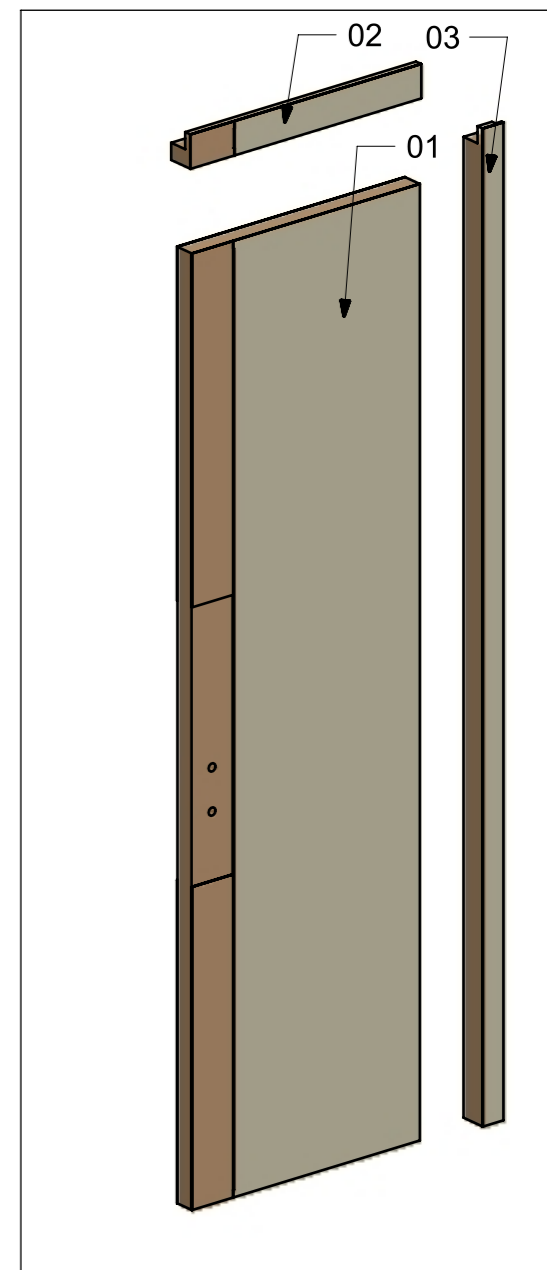

ELEMENTI DA MONTARE  
in MF\_P08  
e spedire con unico imballo

VERNICIATURA LASTRA/LACCATI: ● = VERNICIARE 1 LATO + FILI RASATI O BORDATI

NESSUN SIMBOLO = VERNICIARE 2 LATI + FILI RASATI O BORDATI

LOCALE	CODICE	DESCRIZIONE COMPONENTE	FINITURA	GR.
PORTE	MD321_R01_P09	PORTA BAGNO OSPITI DX	LASTRA SCURA	PTP

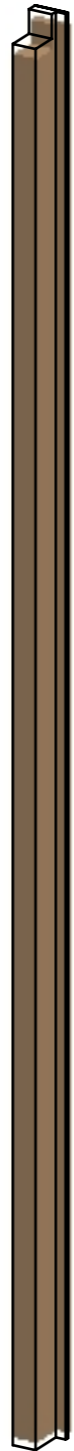
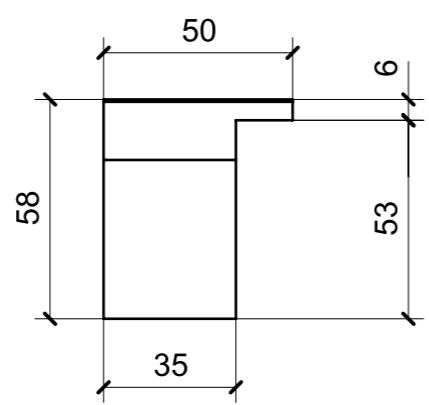
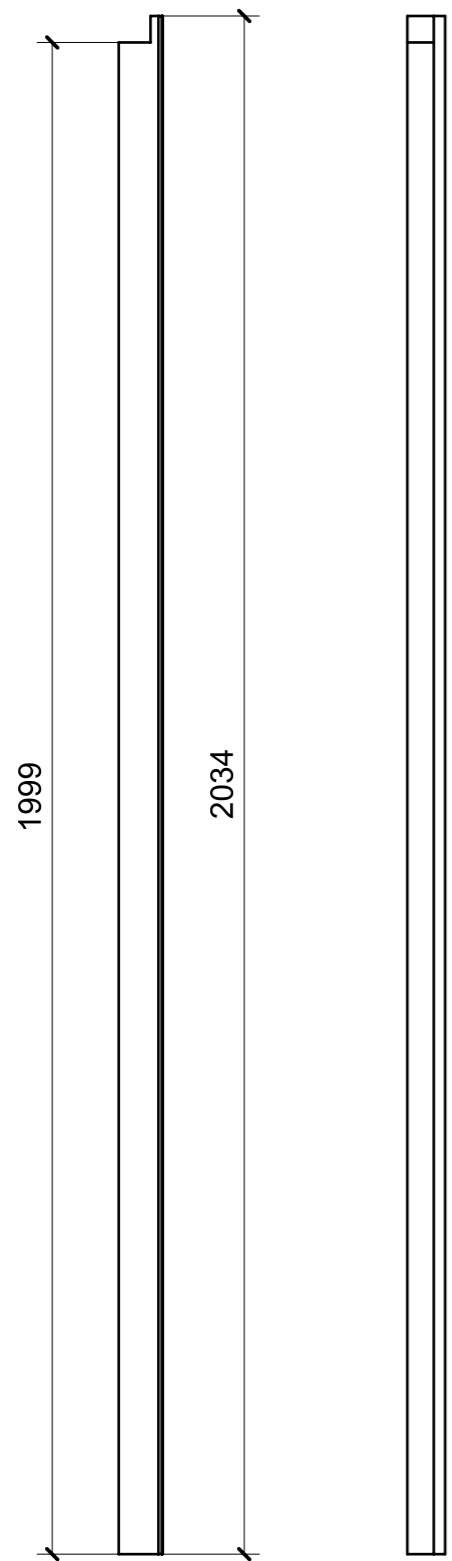

ELEMENTO DA MONTARE  
in MF\_P09  
e spedire con unico imballo

01

VERNICIATURA LASTRA/LACCATI:  
● = VERNICIARE 1 LATO + FILI RASATI O BORDATI      NESSUN SIMBOLO = VERNICIARE 2 LATI + FILI RASATI O BORDATI

LOCALE	CODICE	DESCRIZIONE COMPONENTE	FINITURA	GR.
PORTE	MD321_R02_P09	PORTA BAGNO OSPITI DX	LASTRA CHIARA	PTP

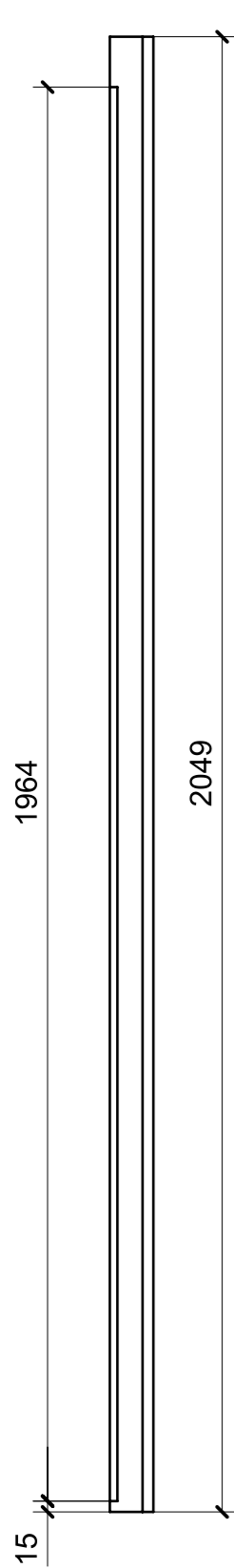

01

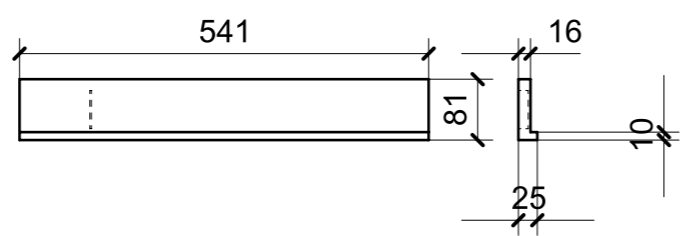

02

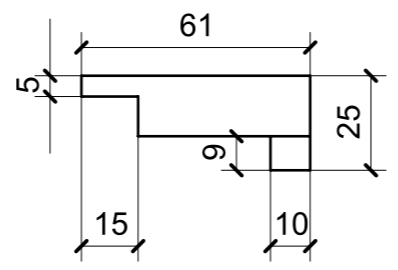
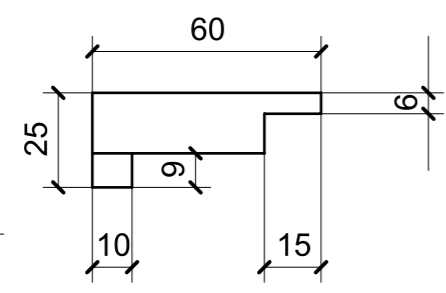

03

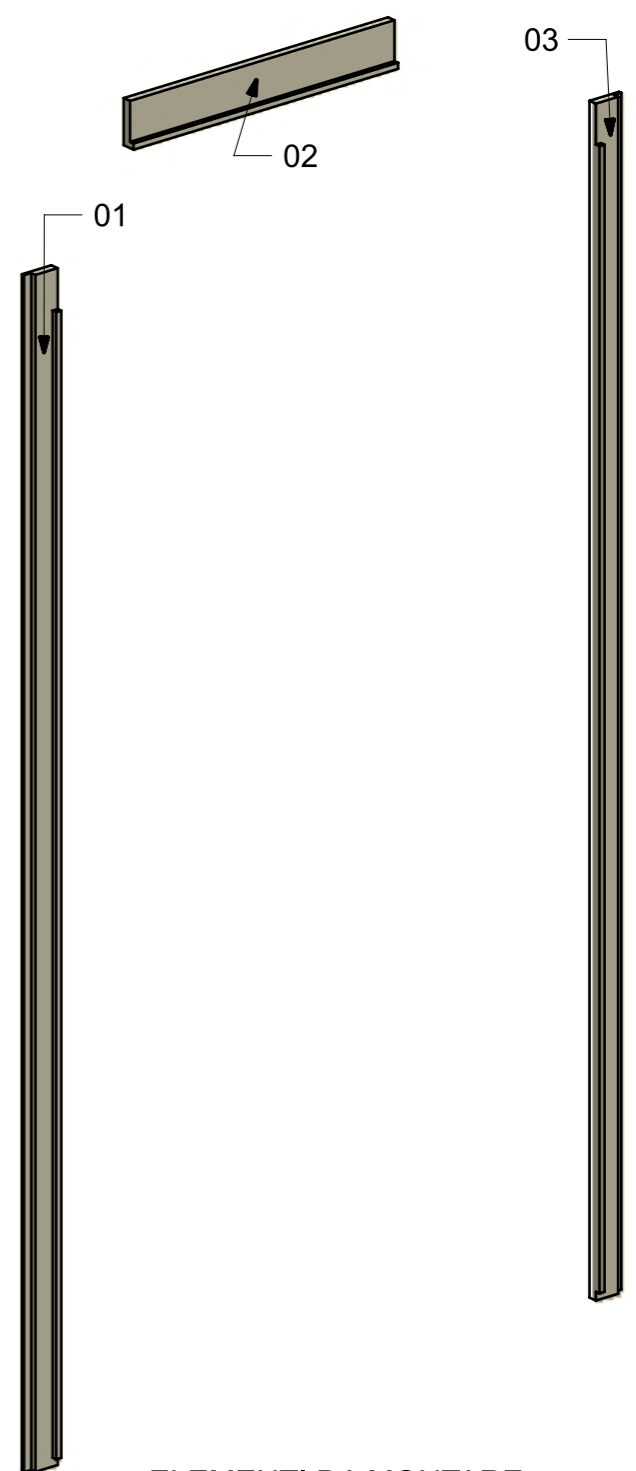

ELEMENTI DA MONTARE  
in MF\_P09  
e spedire con unico imballo

VERNICIATURA LASTRA/LACCATI:  
● = VERNICIARE 1 LATO + FILI RASATI O BORDATI

NESSUN SIMBOLO = VERNICIARE 2 LATI + FILI RASATI O BORDATI

LOCALE	CODICE	DESCRIZIONE COMPONENTE	FINITURA	GR.
PORTE	MD321_R00_P09	PORTA BAGNO OSPITI DX	LASTRA CHIARA E SCURA	PTP

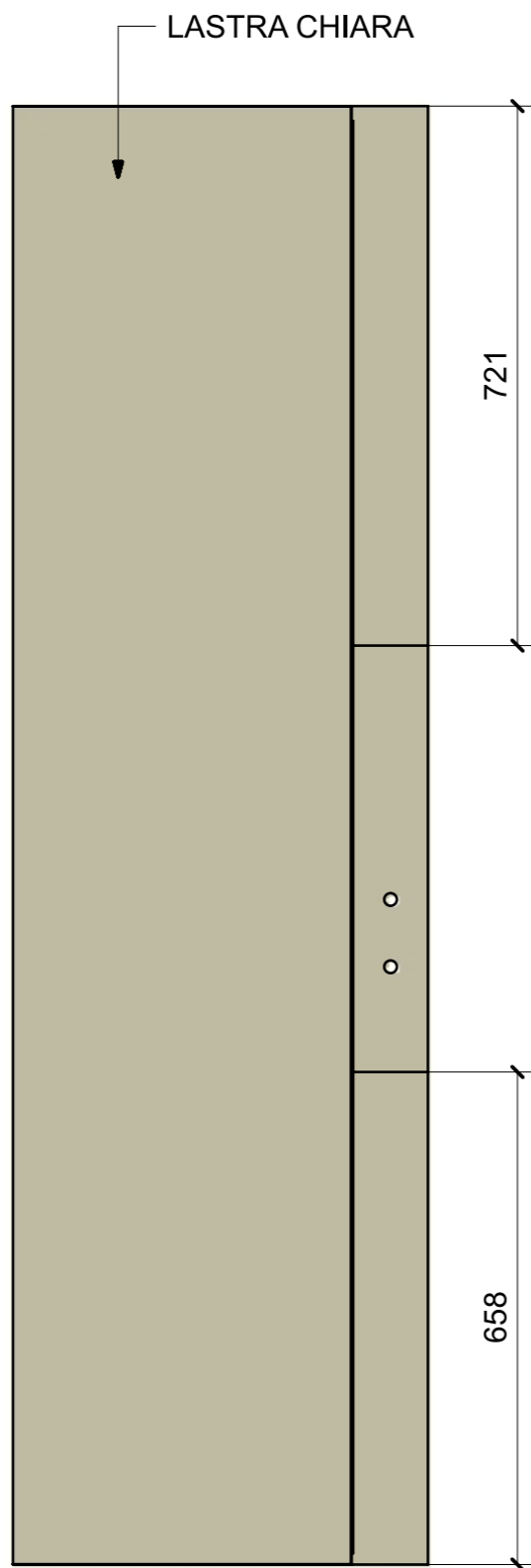
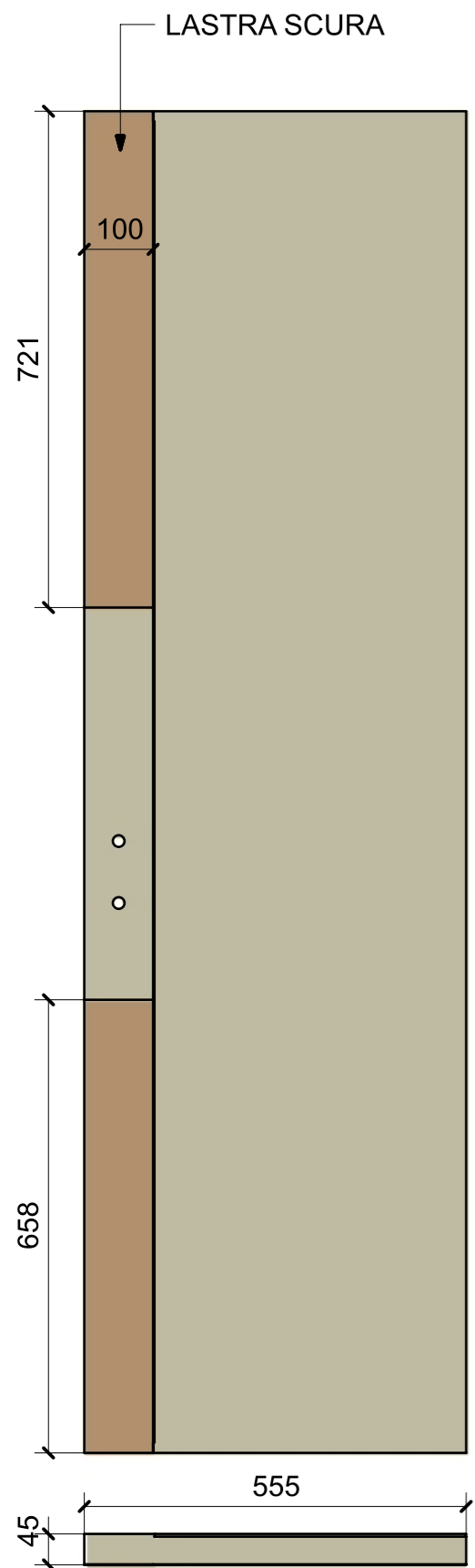

02

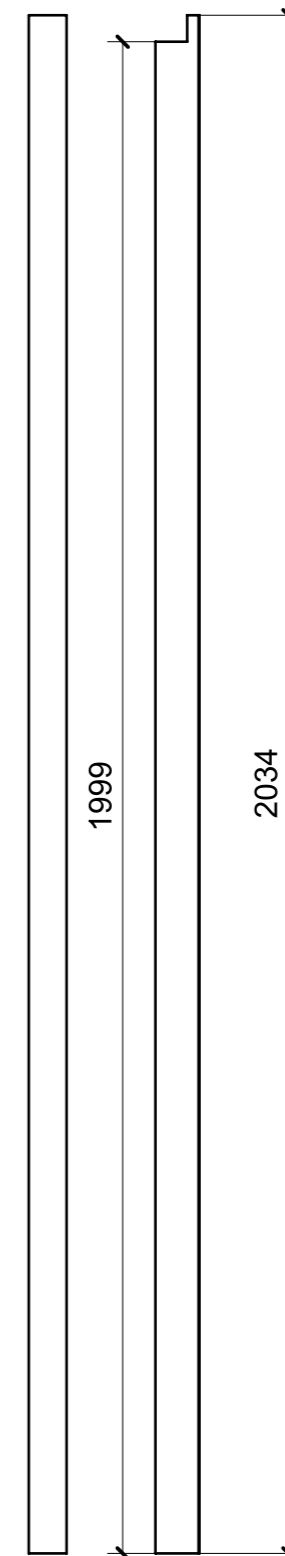
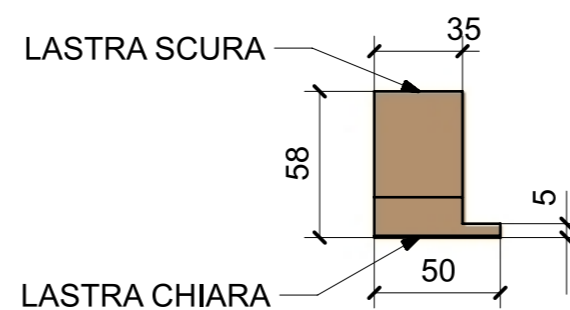
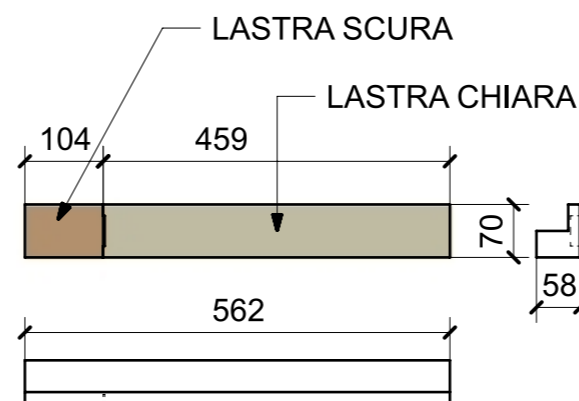

03

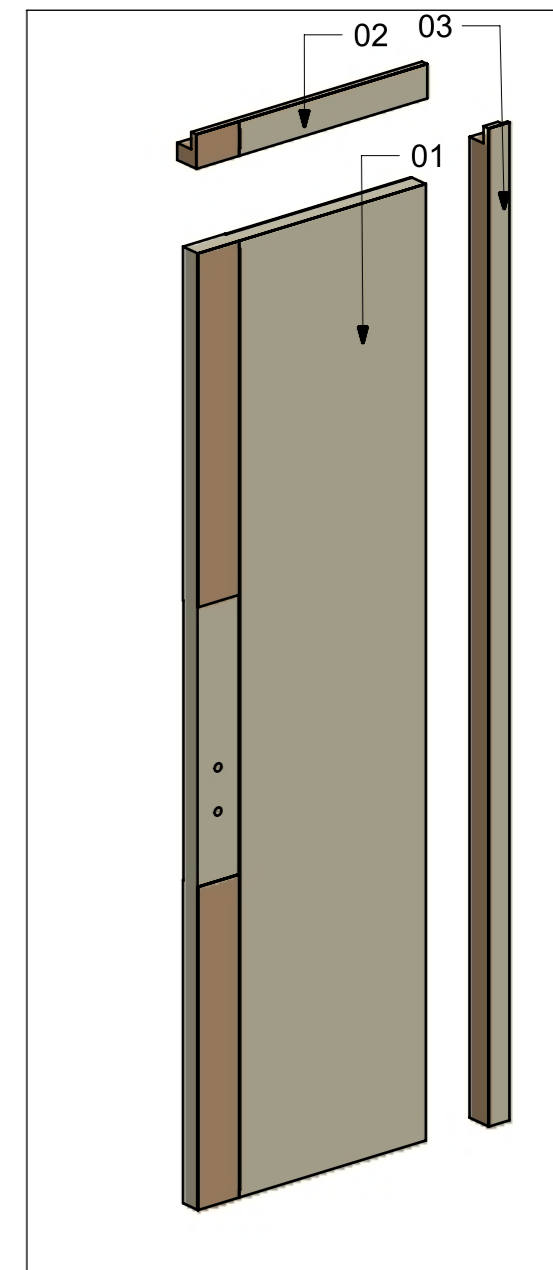
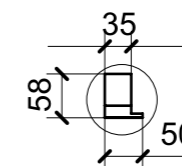

ELEMENTI DA MONTARE  
in MF\_P09  
e spedire con unico imballo

01

VERNICIATURA LASTRA/LACCATI: ● = VERNICIARE 1 LATO + FILI RASATI O BORDATI

NESSUN SIMBOLO = VERNICIARE 2 LATI + FILI RASATI O BORDATI

LOCALE	CODICE	DESCRIZIONE COMPONENTE	FINITURA	GR.
PORTE	MD321_R01_P10	PORTA CABINA OSPITI SX	LASTRA SCURA	PTP

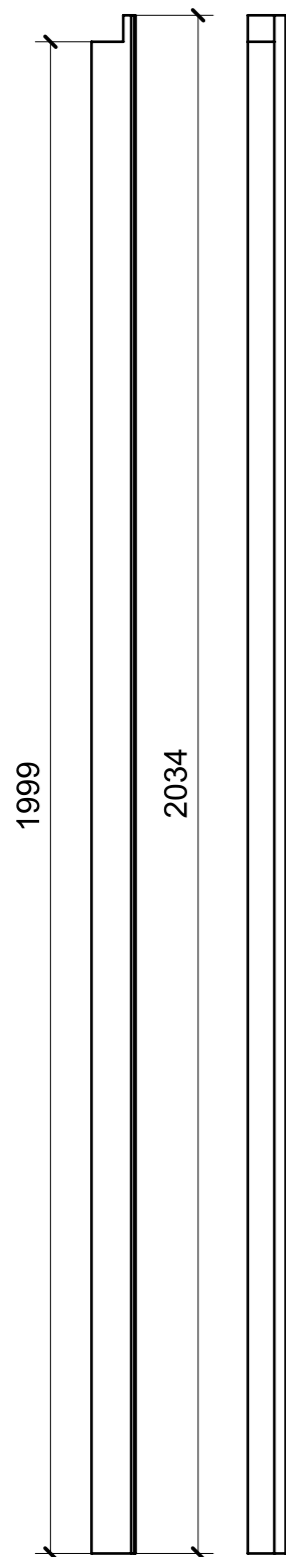

01

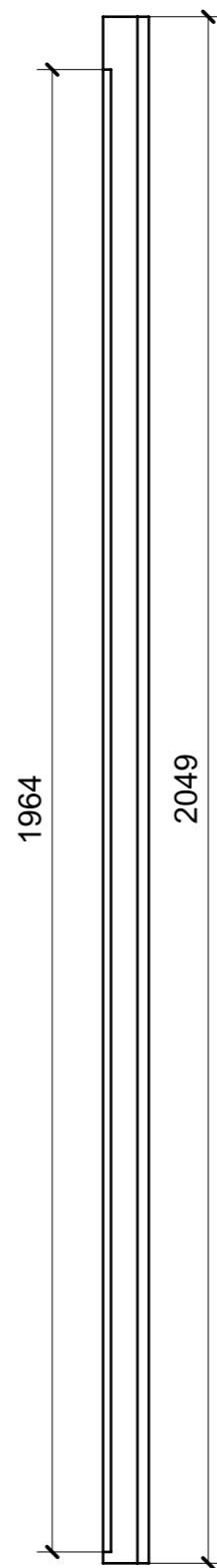
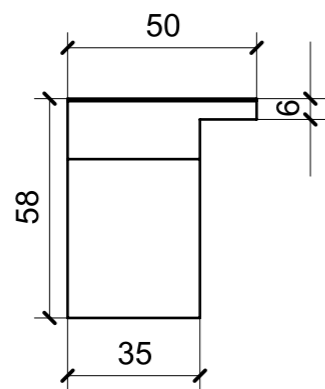
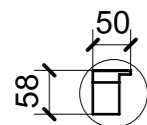

02

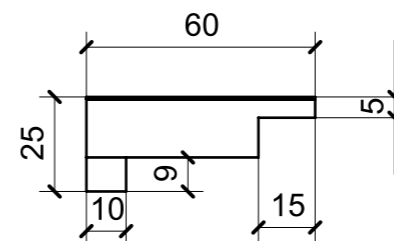
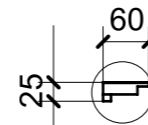

VERNICIATURA LASTRA/LACCATI:

● = VERNICIARE 1 LATO + FILI RASATI O BORDATI

NESSUN SIMBOLO = VERNICIARE 2 LATI + FILI RASATI O BORDATI

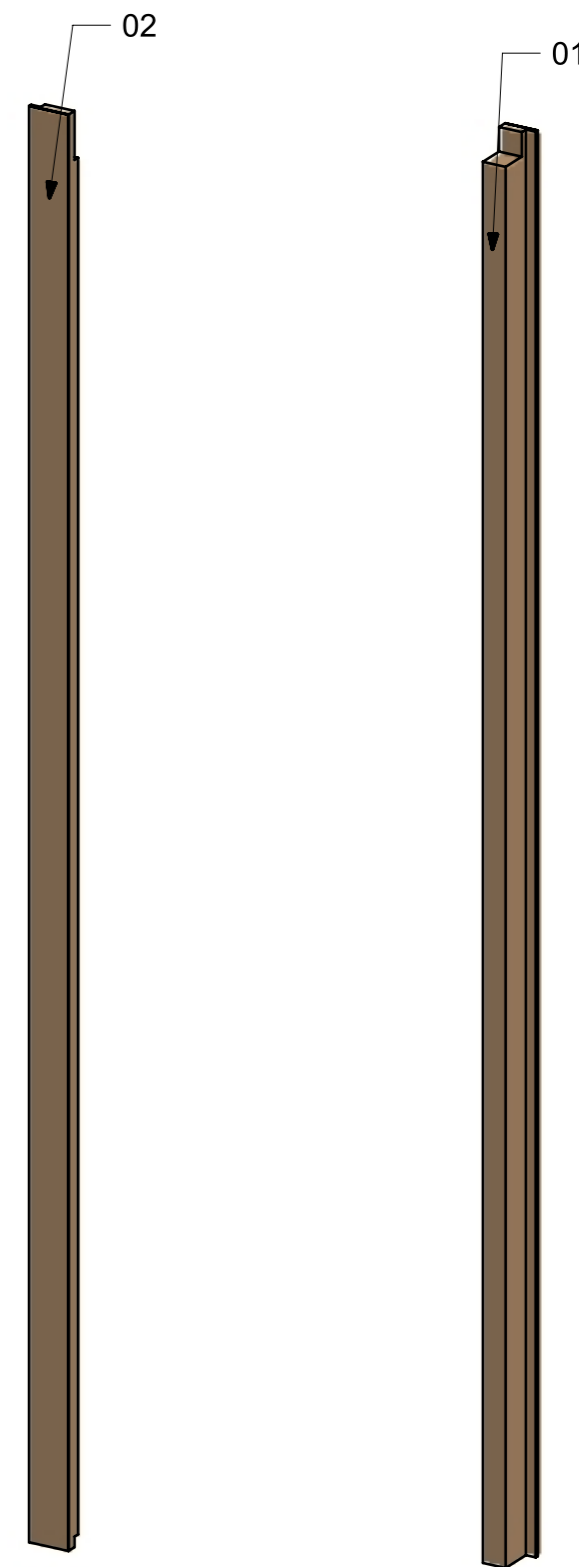

ELEMENTI DA MONTARE  
in MF\_P10  
e spedire con unico imballo

LOCALE	CODICE	DESCRIZIONE COMPONENTE	FINITURA	GR.
PORTE	MD321_R02_P10	PORTA CABINA OSPITI SX	LASTRA CHIARA	PTP

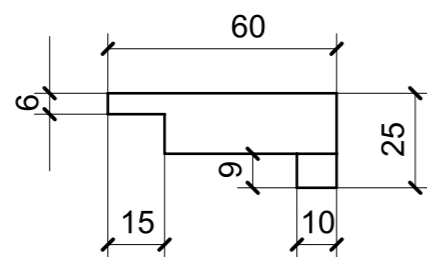
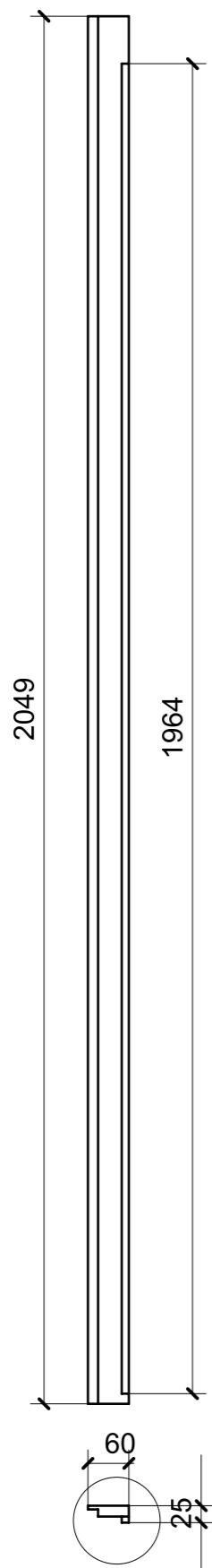

ELEMENTO DA MONTARE  
in MF\_P10  
e spedire con unico imballo

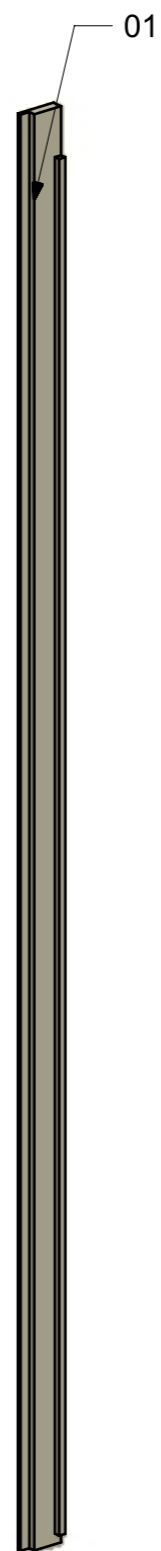

01

VERNICIATURA LASTRA/LACCATI:

● = VERNICIARE 1 LATO + FILI RASATI O BORDATI

NESSUN SIMBOLO = VERNICIARE 2 LATI + FILI RASATI O BORDATI

LOCALE	CODICE	DESCRIZIONE COMPONENTE	FINITURA	GR.
PORTE	MD321_R00_P10	PORTA CABINA OSPITI SX	LASTRA CHIARA E SCURA	PTP

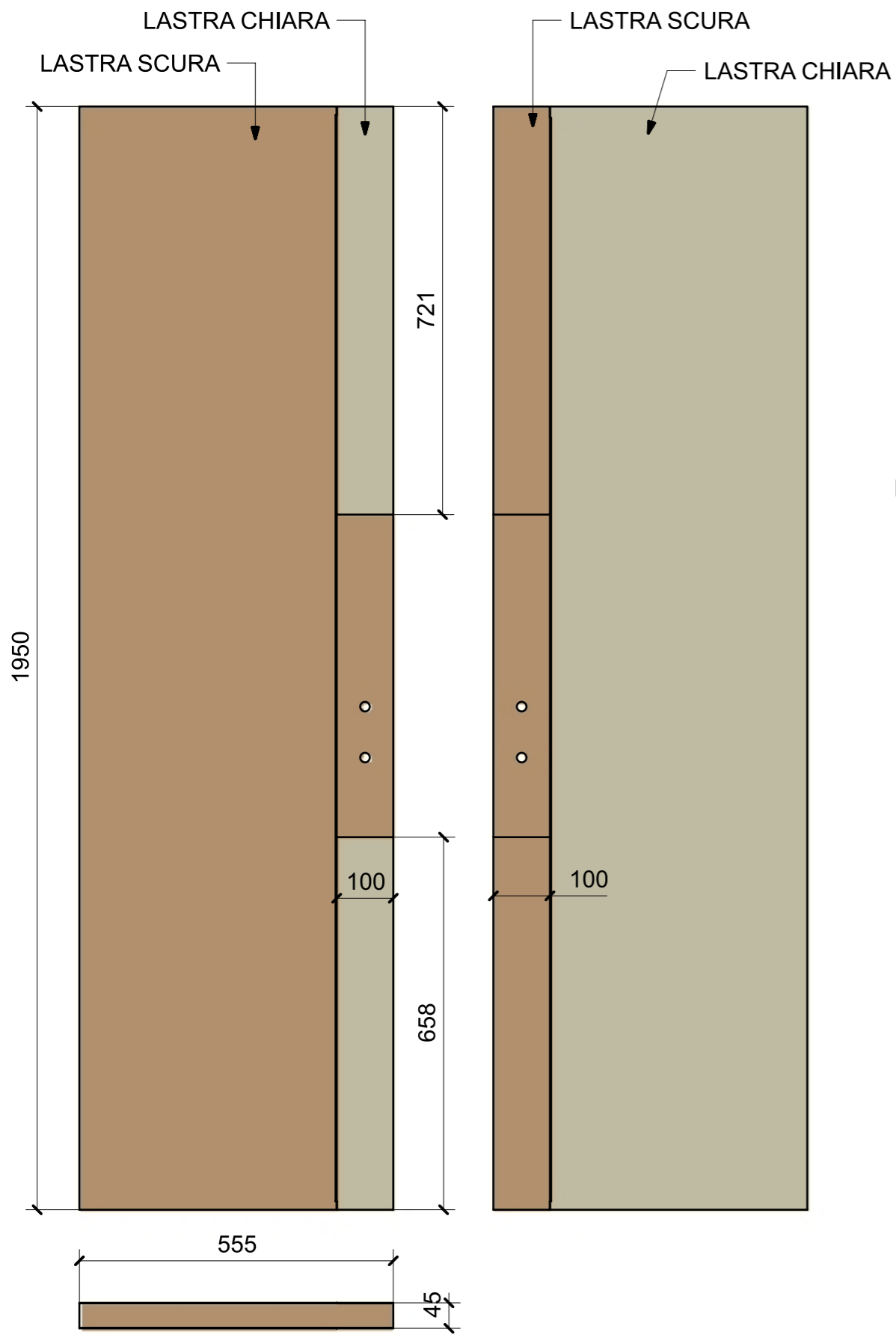

01

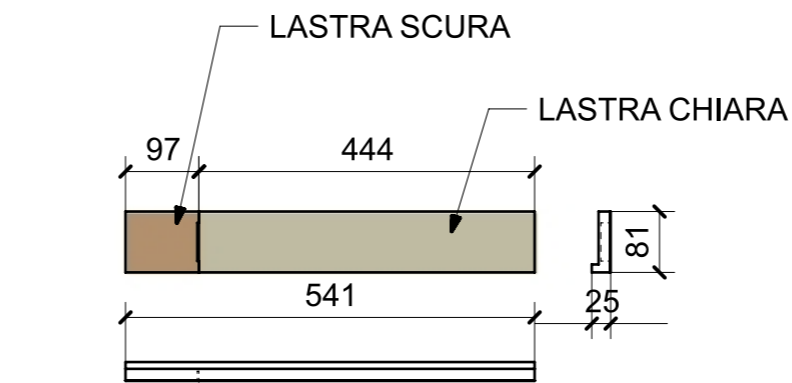

02

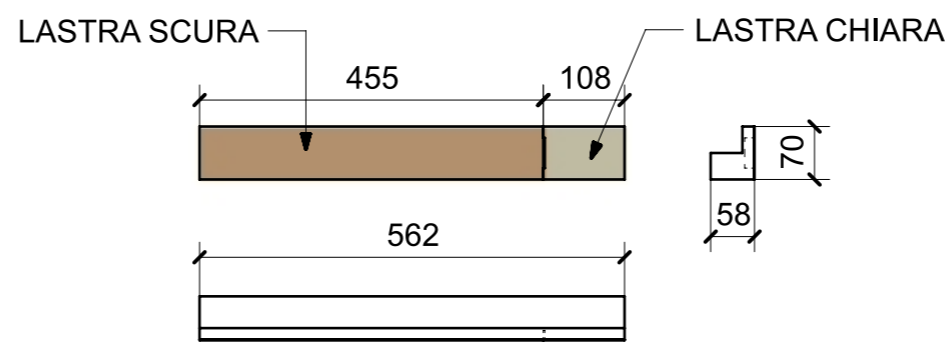

03

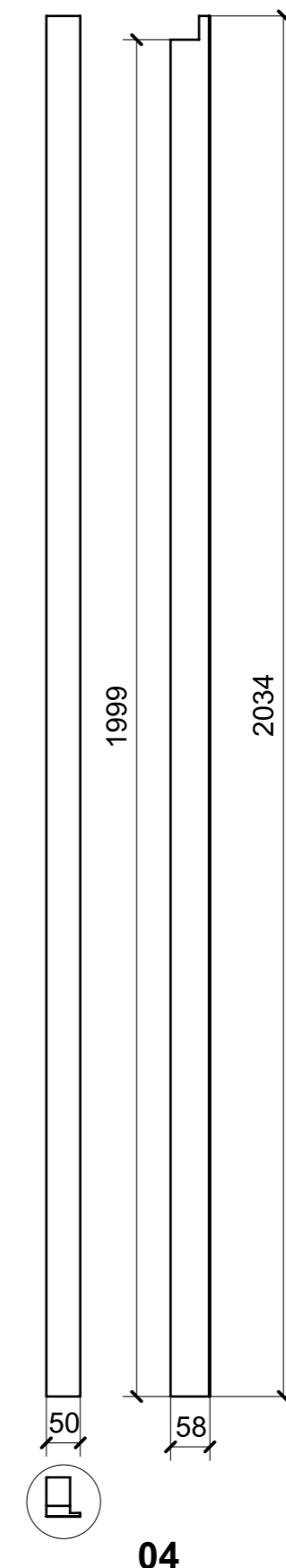
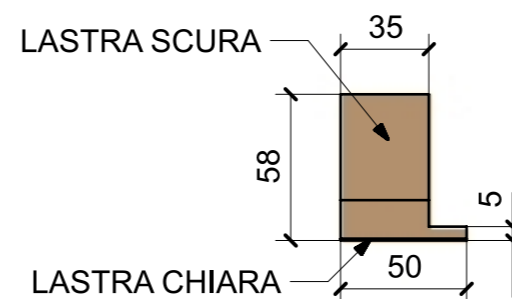

04

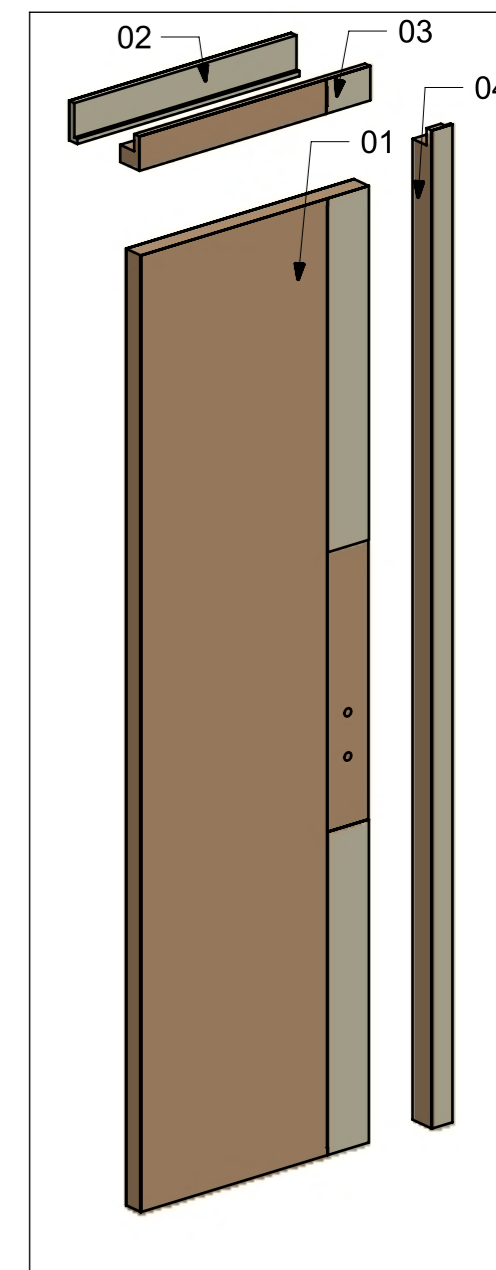

ELEMENTI DA MONTARE  
in MF\_P10  
e spedire con unico imballo

VERNICIATURA LASTRA/LACCATI: ● = VERNICIARE 1 LATO + FILI RASATI O BORDATI

NESSUN SIMBOLO = VERNICIARE 2 LATI + FILI RASATI O BORDATI

LOCALE	CODICE	DESCRIZIONE COMPONENTE	FINITURA	GR.
PORTE	MD321_R01_P11	PORTA BAGNO OSPITI SX	LASTRA SCURA	PTP

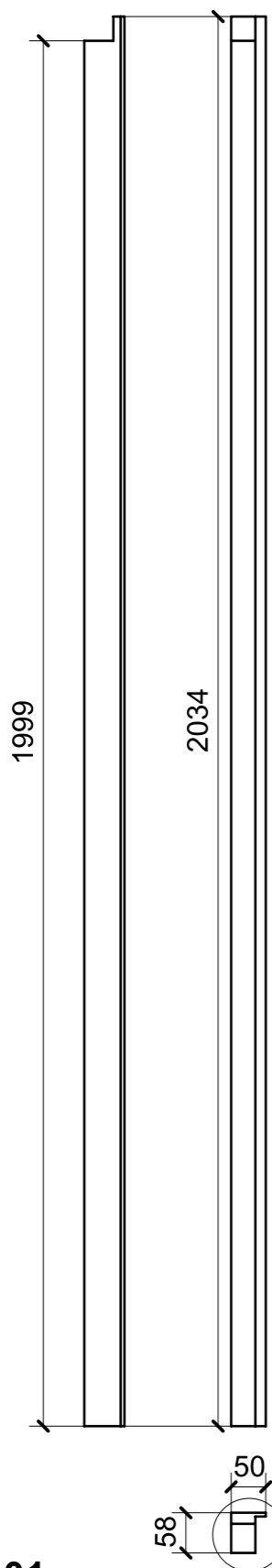

01

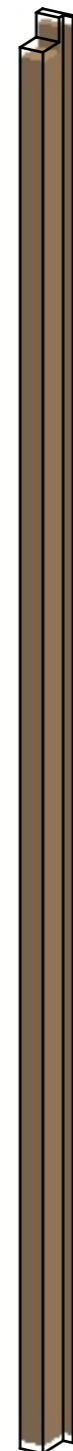
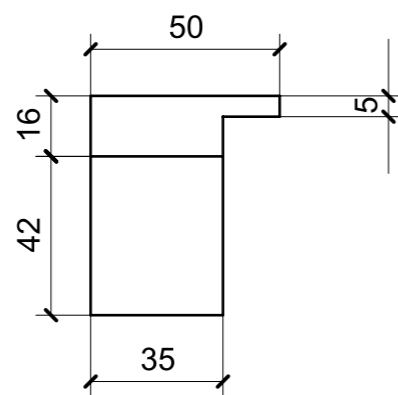

ELEMENTO DA MONTARE  
in MF\_P11  
e spedire con unico imballo

VERNICIATURA LASTRA/LACCATI:

● = VERNICIARE 1 LATO + FILI RASATI O BORDATI

NESSUN SIMBOLO = VERNICIARE 2 LATI + FILI RASATI O BORDATI

LOCALE	CODICE	DESCRIZIONE COMPONENTE	FINITURA	GR.
PORTE	MD321_R02_P11	PORTA BAGNO OSPITI SX	LASTRA CHIARA	PTP

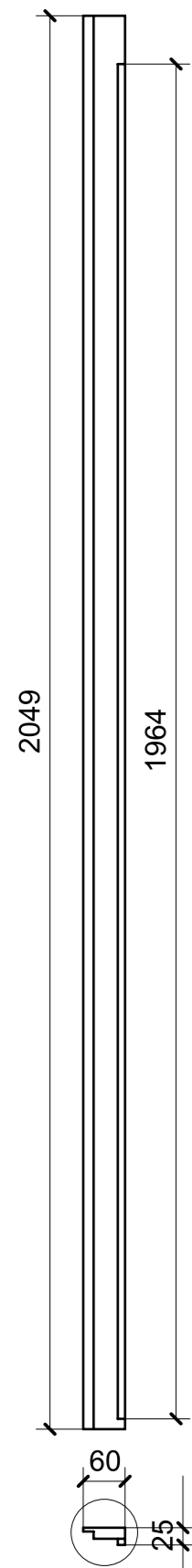

01

02

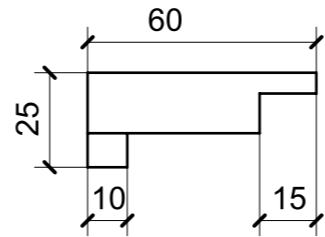
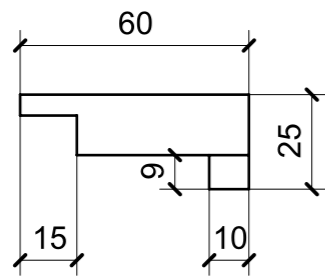
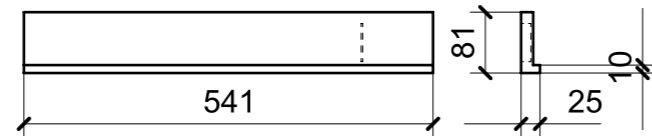

03

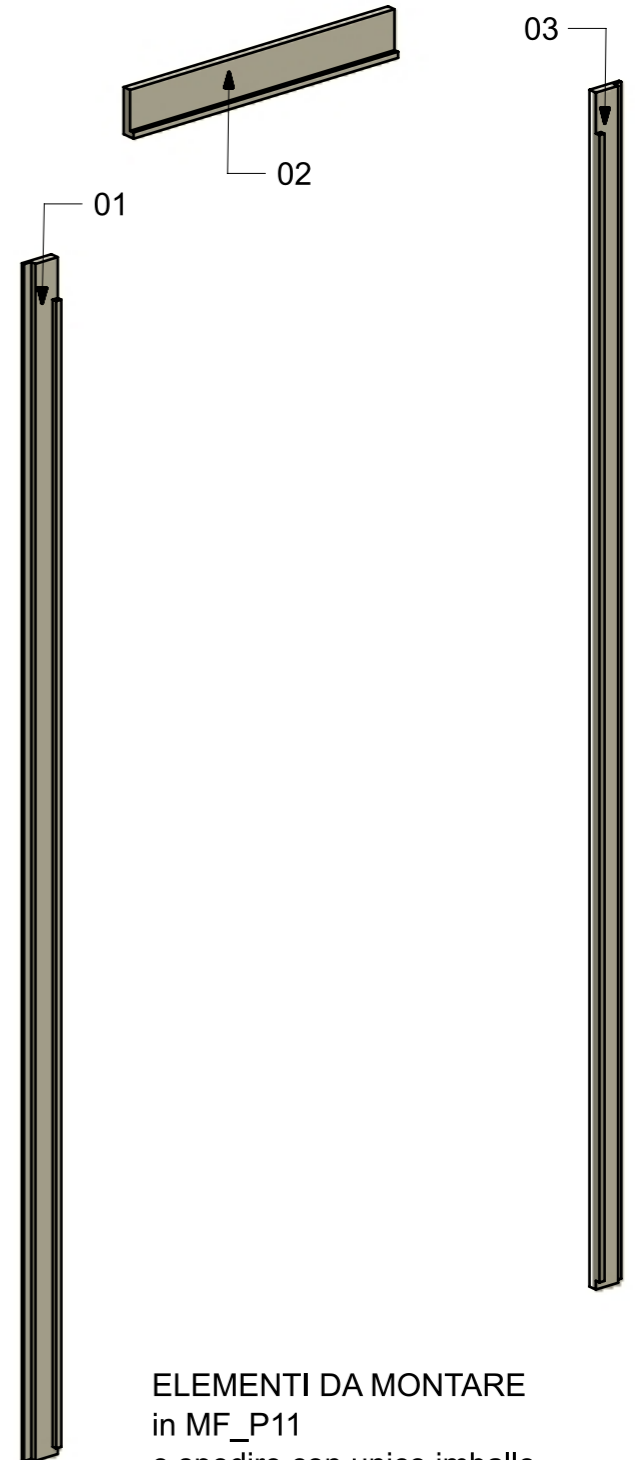
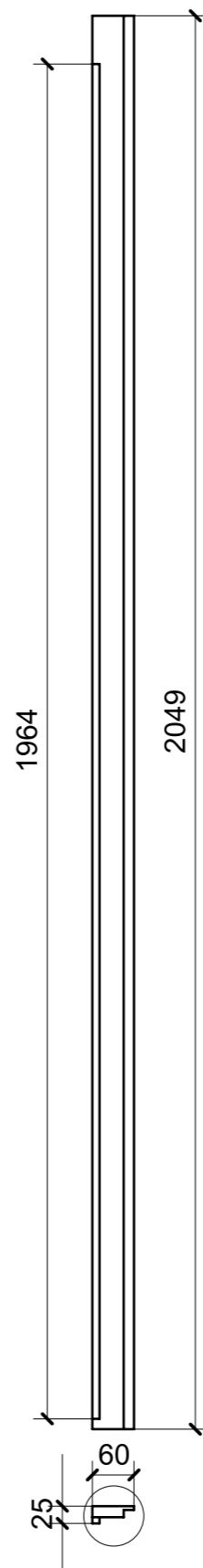

ELEMENTI DA MONTARE  
in MF\_P11  
e spedire con unico imballo

VERNICIATURA LASTRA/LACCATI:

● = VERNICIARE 1 LATO + FILI RASATI O BORDATI

NESSUN SIMBOLO = VERNICIARE 2 LATI + FILI RASATI O BORDATI

LOCALE	CODICE	DESCRIZIONE COMPONENTE	FINITURA	GR.
PORTE	MD321_R00_P11	PORTA BAGNO OSPITI SX	LASTRA CHIARA E SCURA	PTP

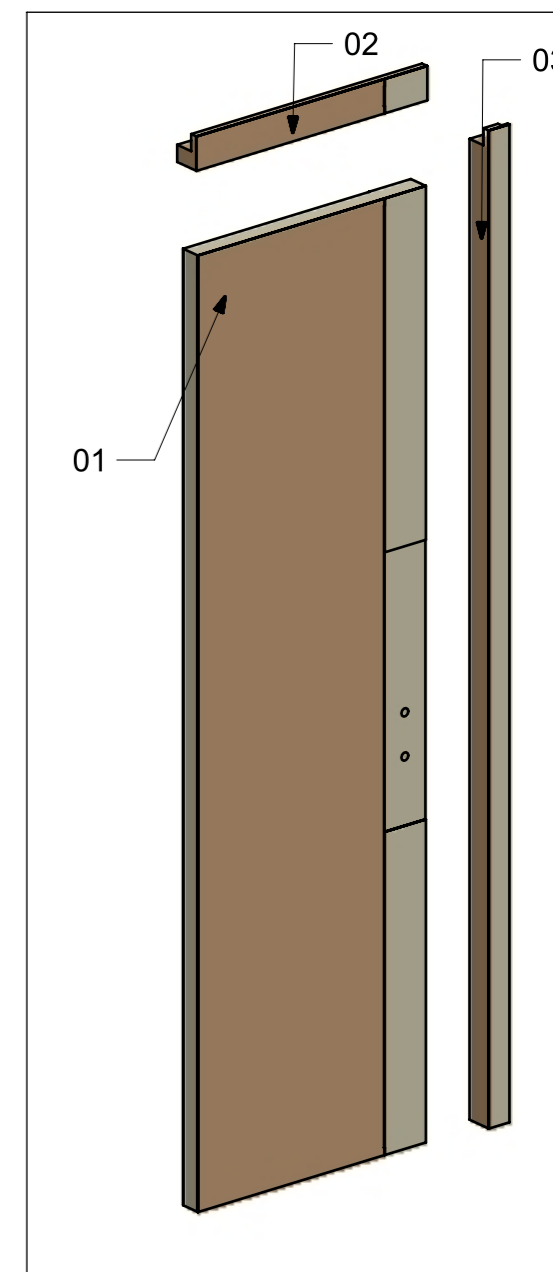
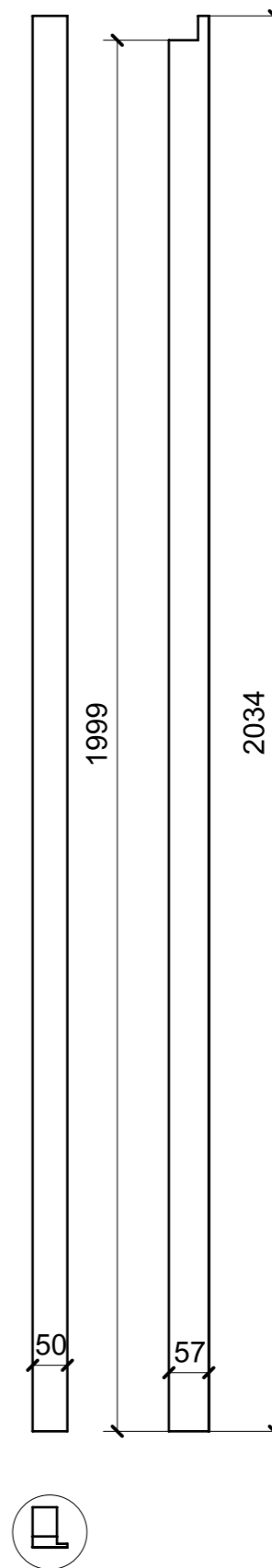
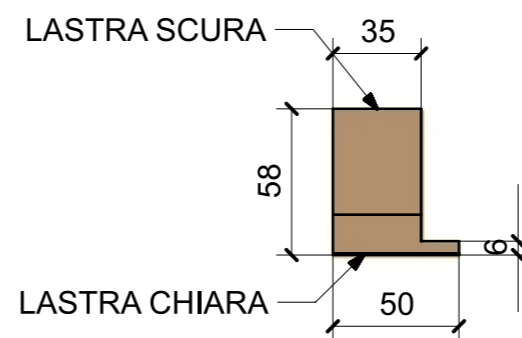
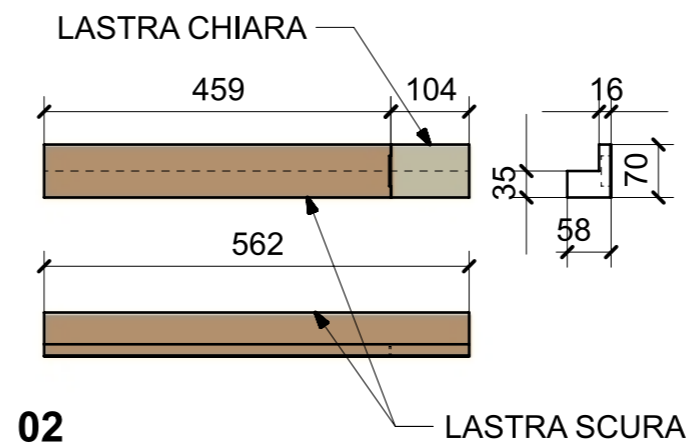
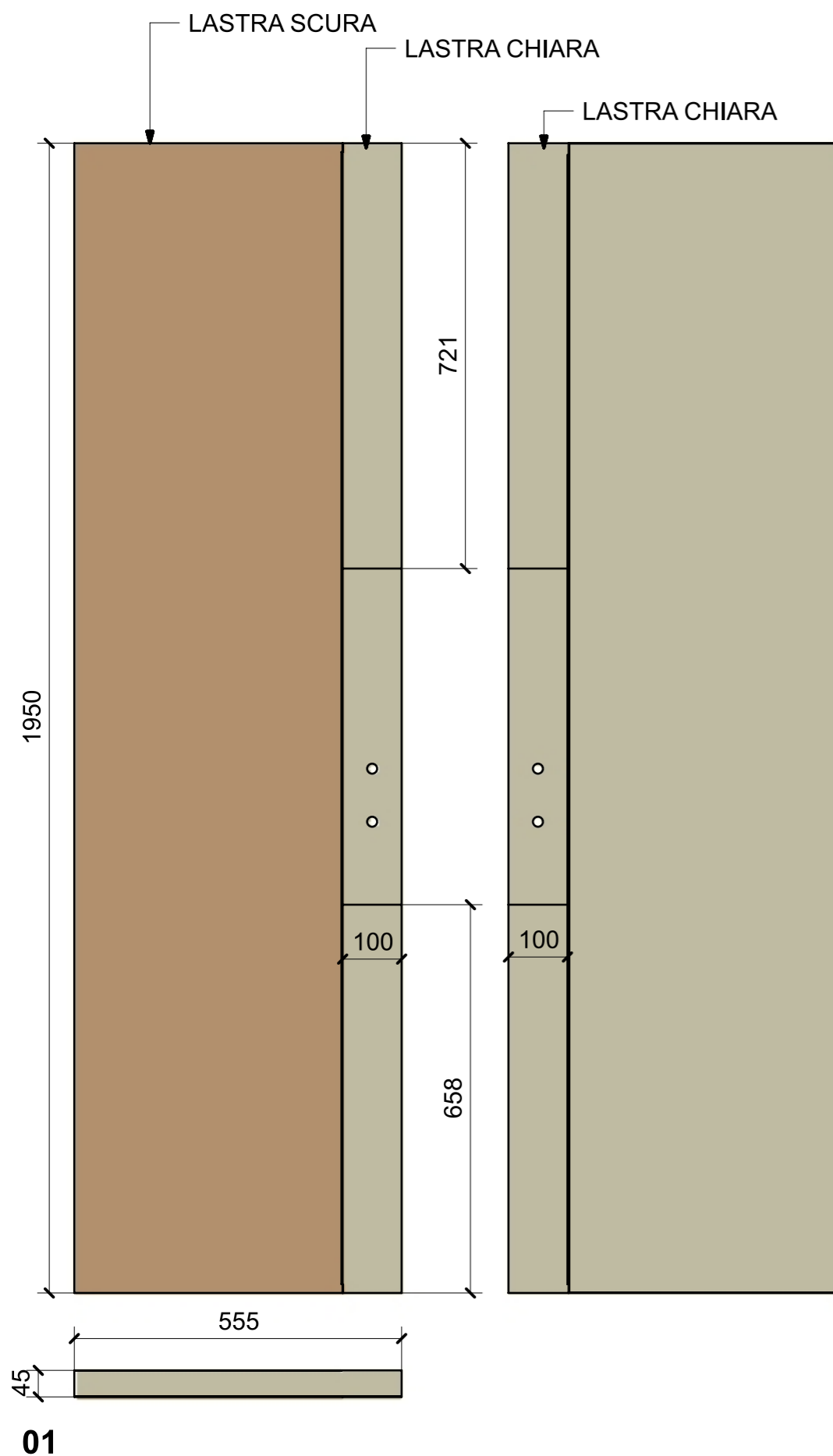

ELEMENTI DA MONTARE  
in MF\_P11  
e spedire con unico imballo

VERNICIATURA LASTRA/LACCATI: ● = VERNICIARE 1 LATO + FILI RASATI O BORDATI

NESSUN SIMBOLO = VERNICIARE 2 LATI + FILI RASATI O BORDATI