

LOCALE	CODICE	DESCRIZIONE COMPONENTE	FINITURA	GR.
CABINA VIP	MD320_R02_VA01	STRUTTURA MURATA TESTATA LETTO	LASTRA CHIARA	3

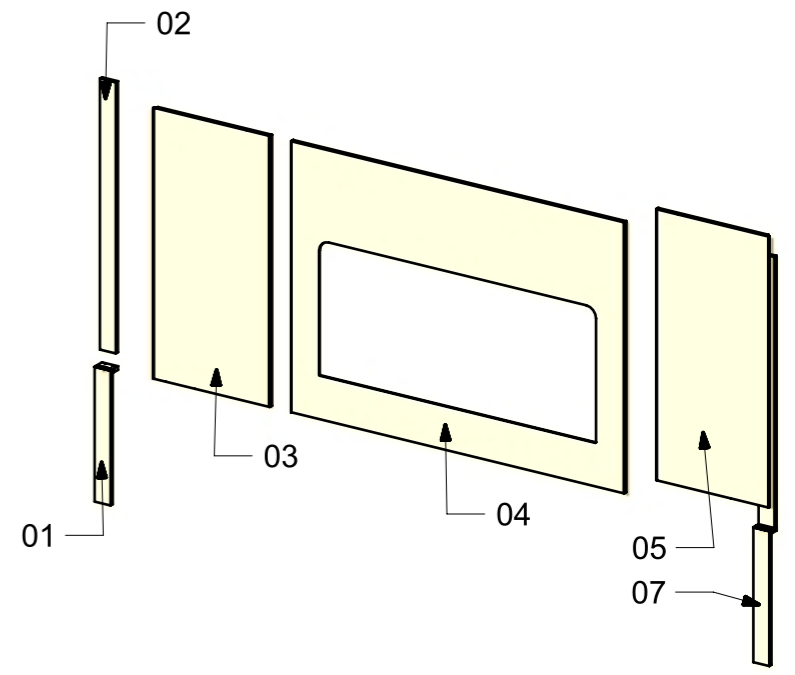
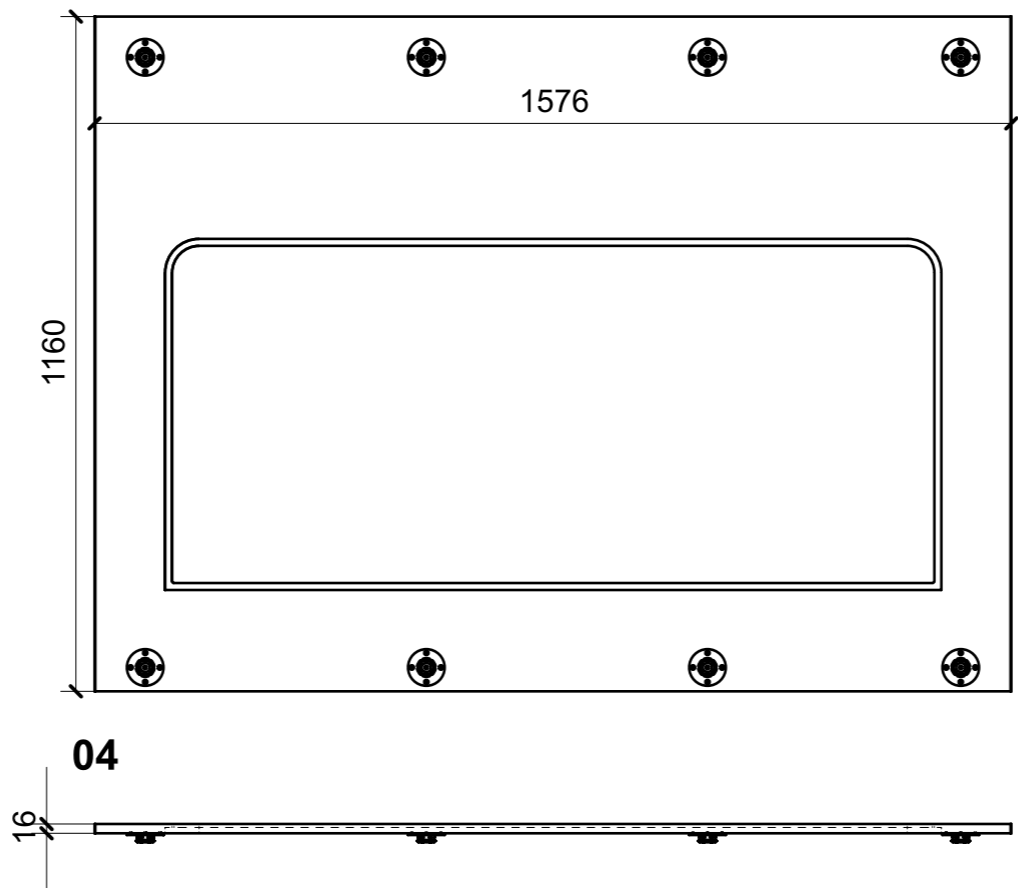
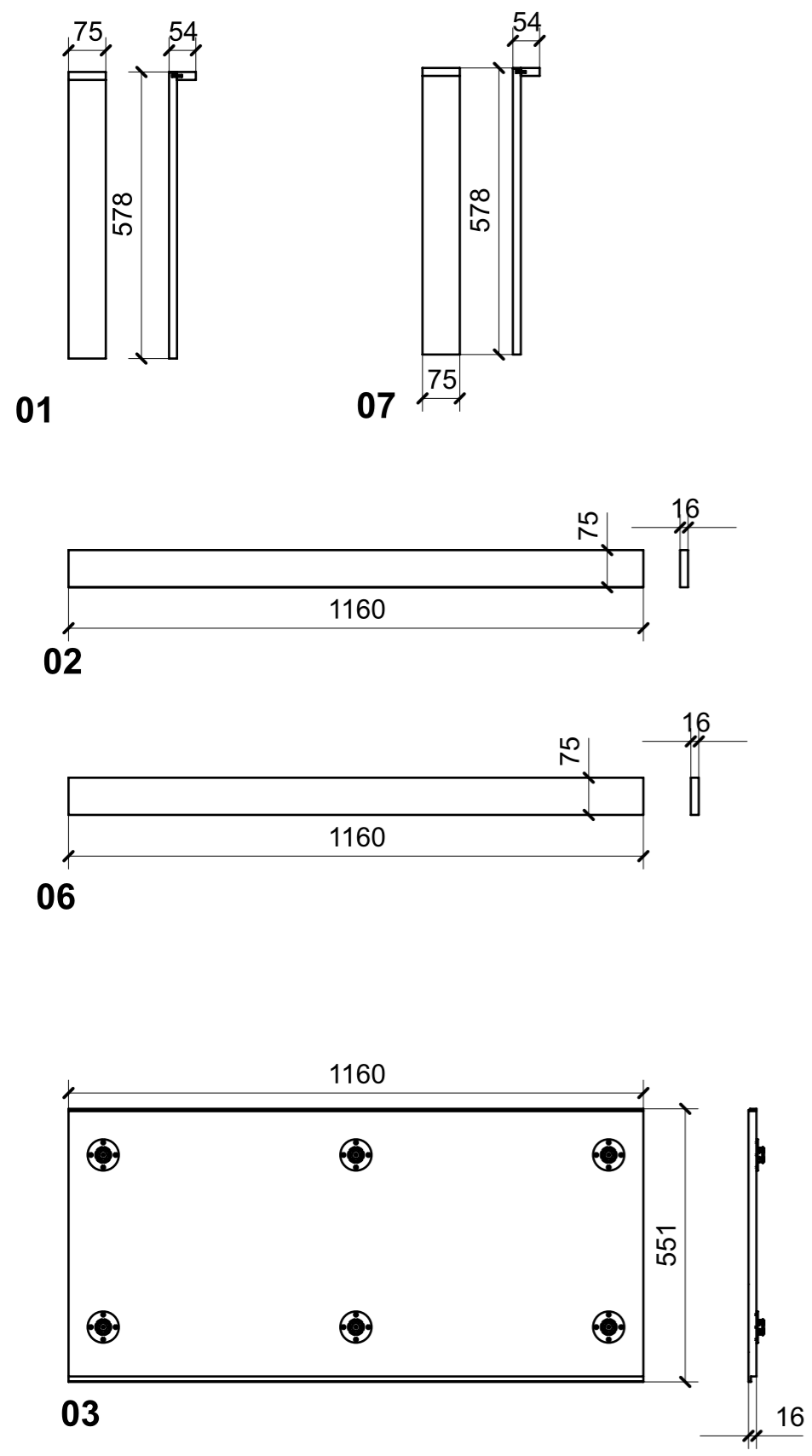

FERRAMENTA	QTY
FITLOCK M_MASCHERPA_3MM_6020202101	20

VERNICIATURA LASTRA/LACCATI: ● = VERNICIARE 1 LATO + FILI RASATI O BORDATI    NESSUN SIMBOLO = VERNICIARE 2 LATI + FILI RASATI O BORDATI

LOCALE	CODICE	DESCRIZIONE COMPONENTE	FINITURA	GR.
CABINA VIP	MD320_R01_VE01	RIVESTIMENTI PARETI PRUA	LASTRA SCURA	3

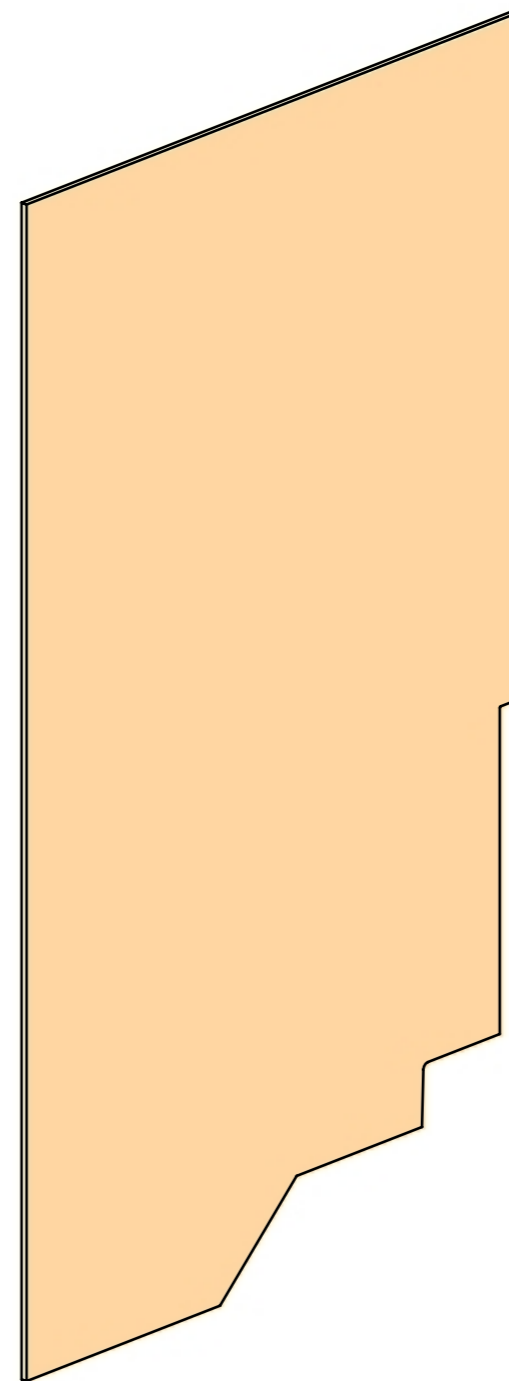
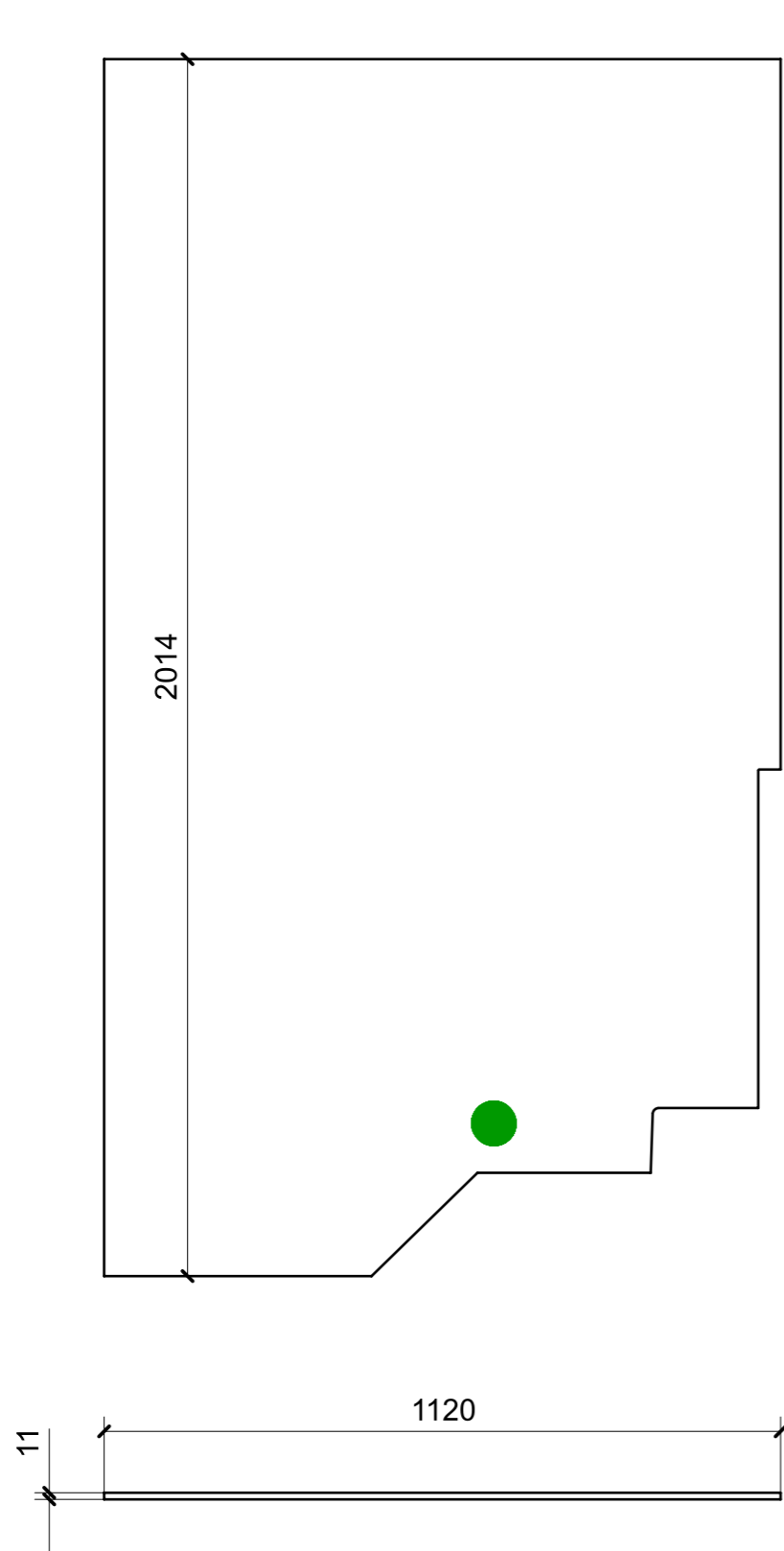

VERNICIATURA LASTRA/LACCATI:

● = VERNICIARE 1 LATO + FILI RASATI O BORDATI

NESSUN SIMBOLO = VERNICIARE 2 LATI + FILI RASATI O BORDATI

LOCALE	CODICE	DESCRIZIONE COMPONENTE	FINITURA	GR.
CABINA VIP	MD320_R02_VE01	RIVESTIMENTI PARETI PRUA	LASTRA CHIARA	3

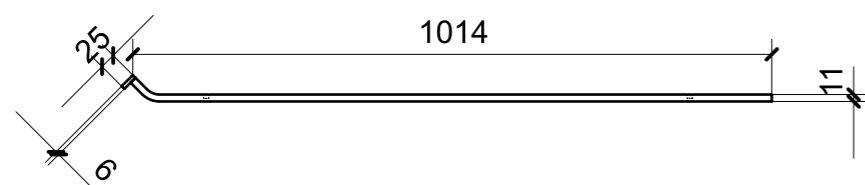
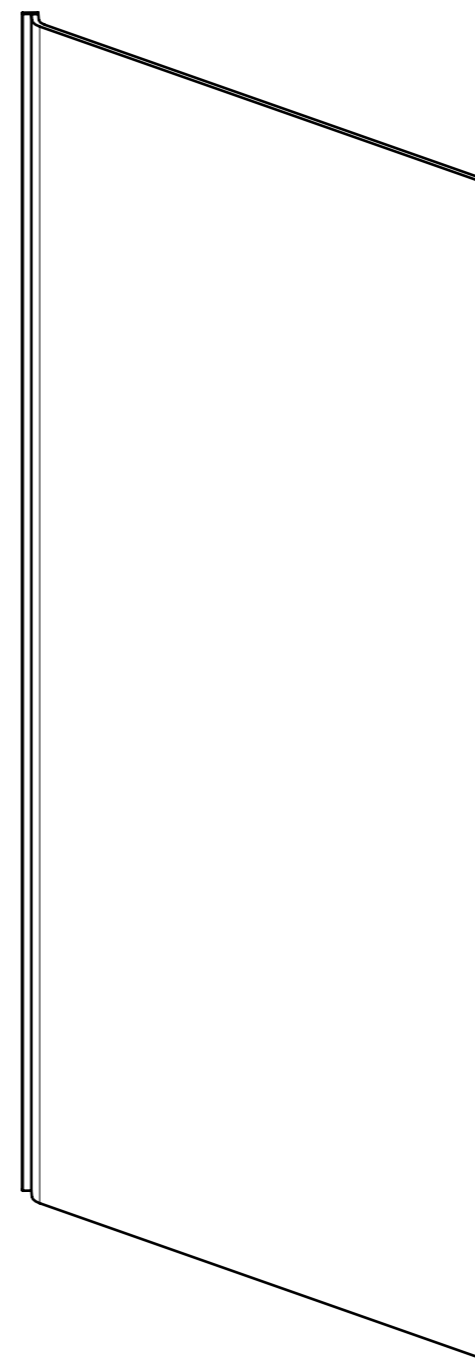
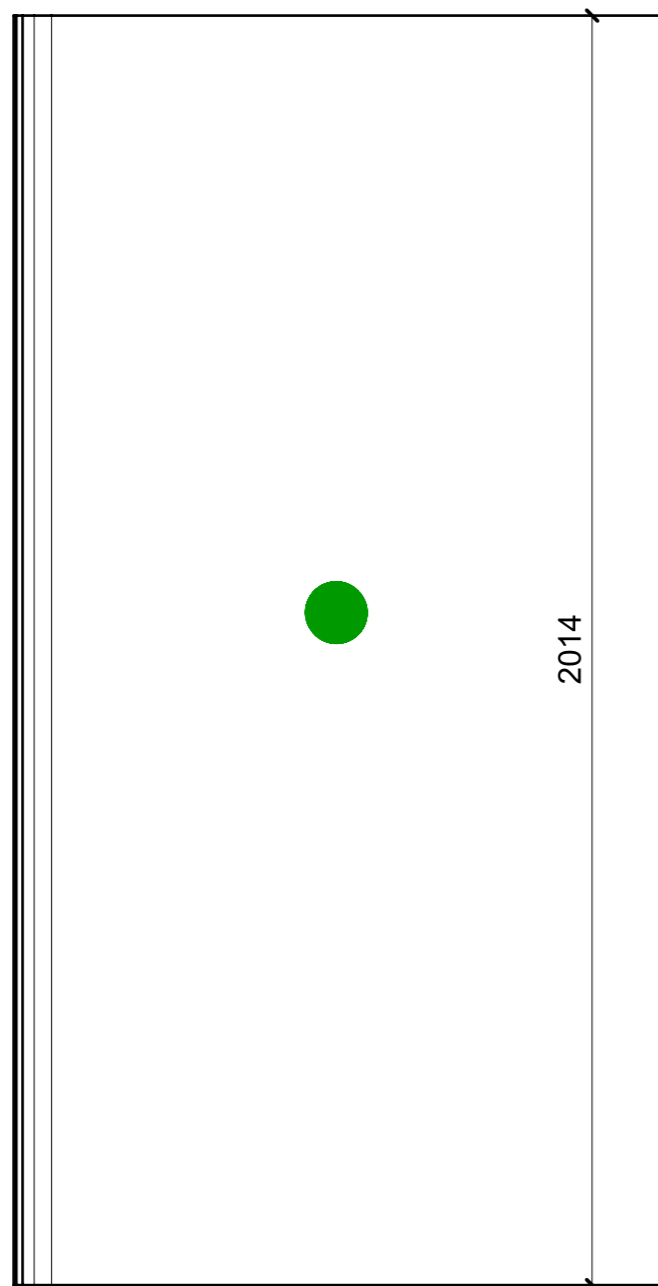

VERNICIATURA LASTRA/LACCATI:

● = VERNICIARE 1 LATO + FILI RASATI O BORDATI

NESSUN SIMBOLO = VERNICIARE 2 LATI + FILI RASATI O BORDATI

LOCALE	CODICE	DESCRIZIONE COMPONENTE	FINITURA	GR.
CABINA VIP	MD320_R01_VF01	RIVESTIMENTI PARETI POPPA	LASTRA SCURA	3

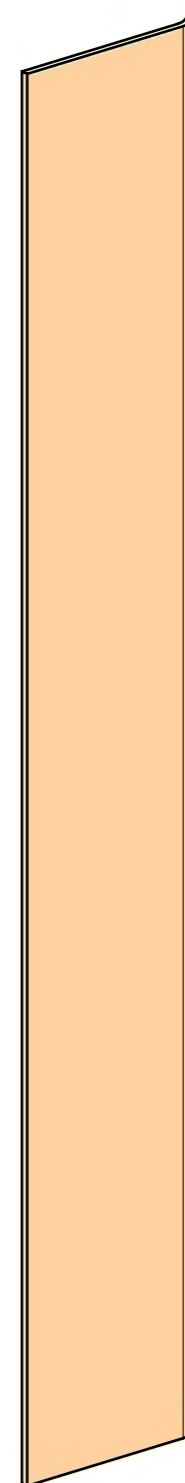
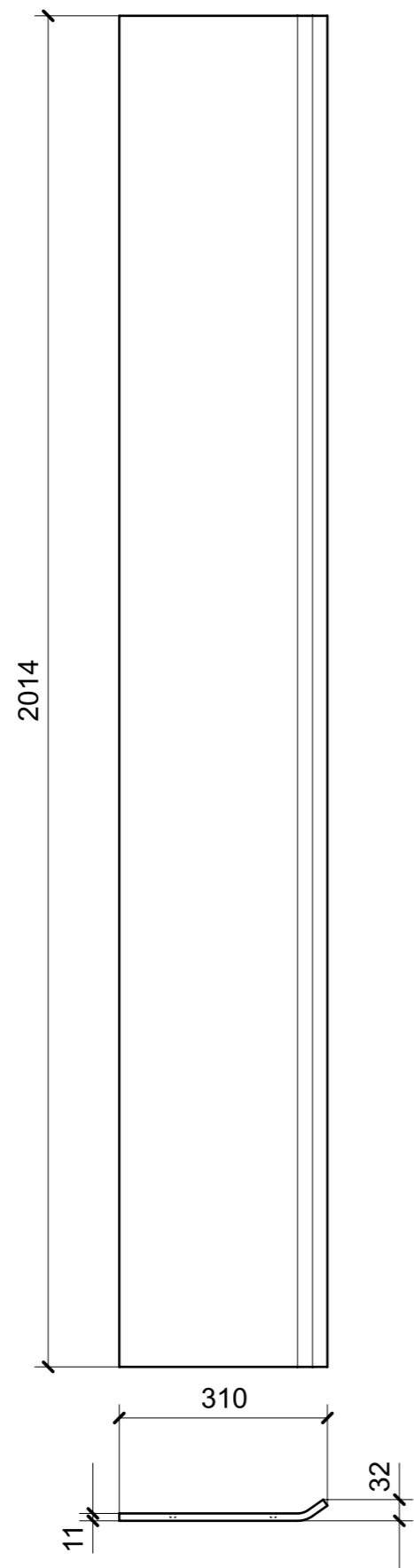

VERNICIATURA LASTRA/LACCATI:

● = VERNICIARE 1 LATO + FILI RASATI O BORDATI

NESSUN SIMBOLO = VERNICIARE 2 LATI + FILI RASATI O BORDATI

LOCALE	CODICE	DESCRIZIONE COMPONENTE	FINITURA	GR.
CABINA VIP	MD320_R02_VF01	RIVESTIMENTI PARETI POPPA	LASTRA CHIARA	3

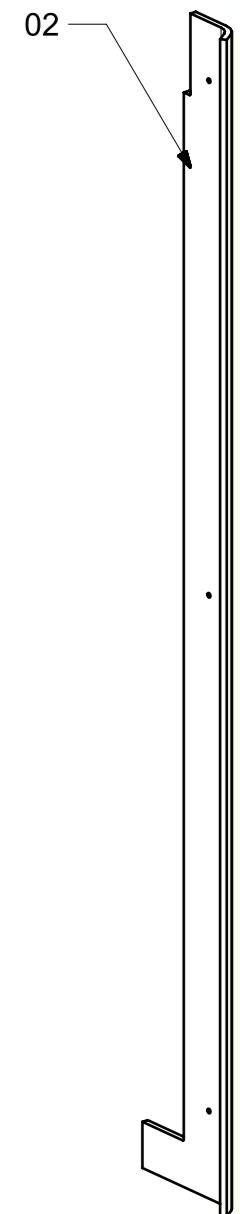
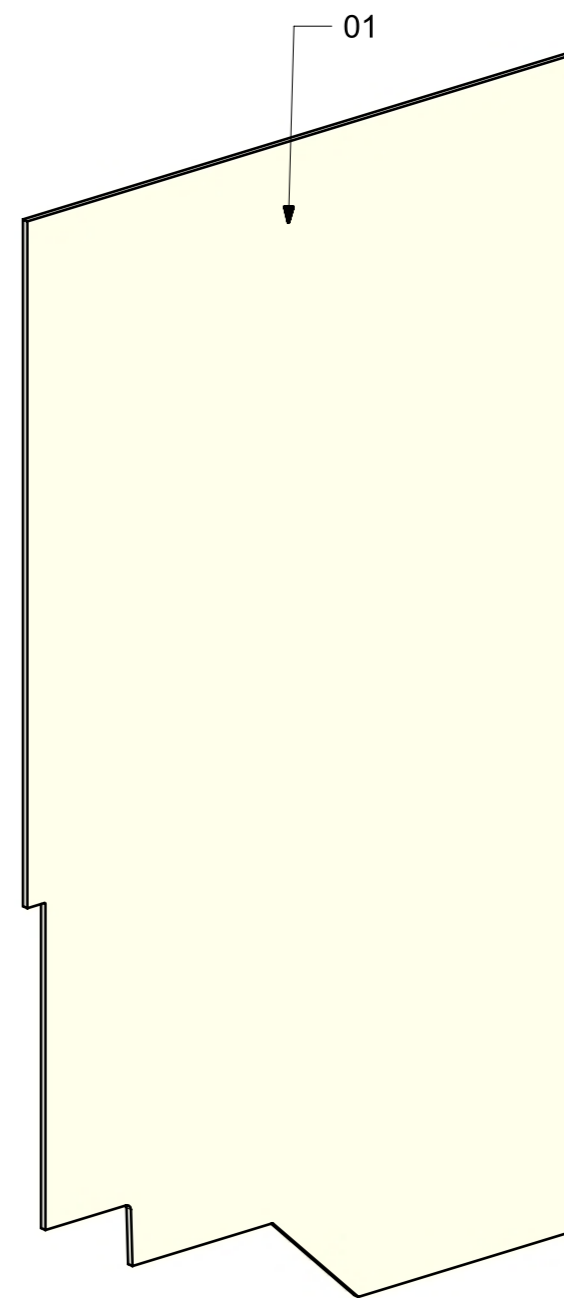
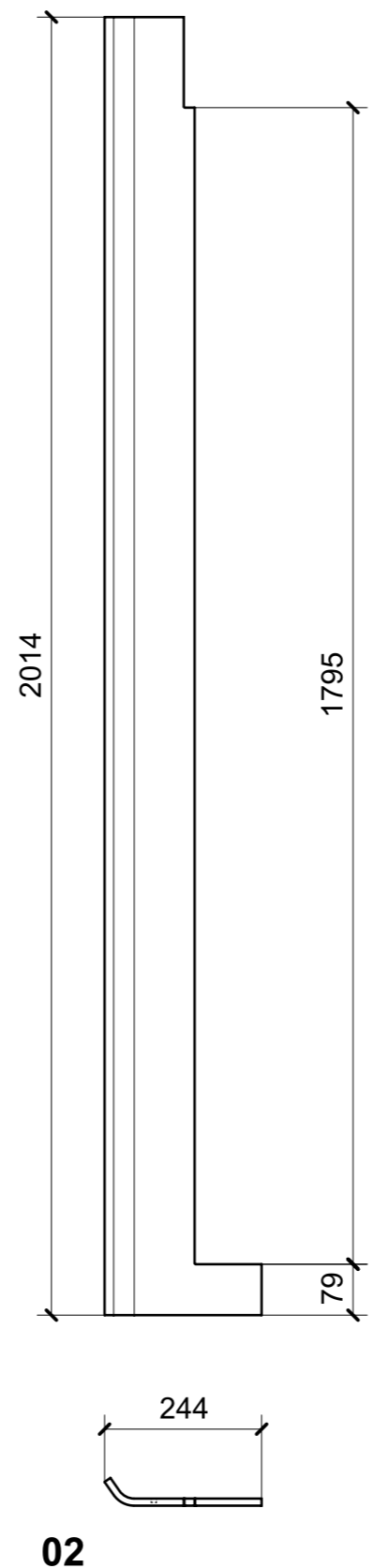
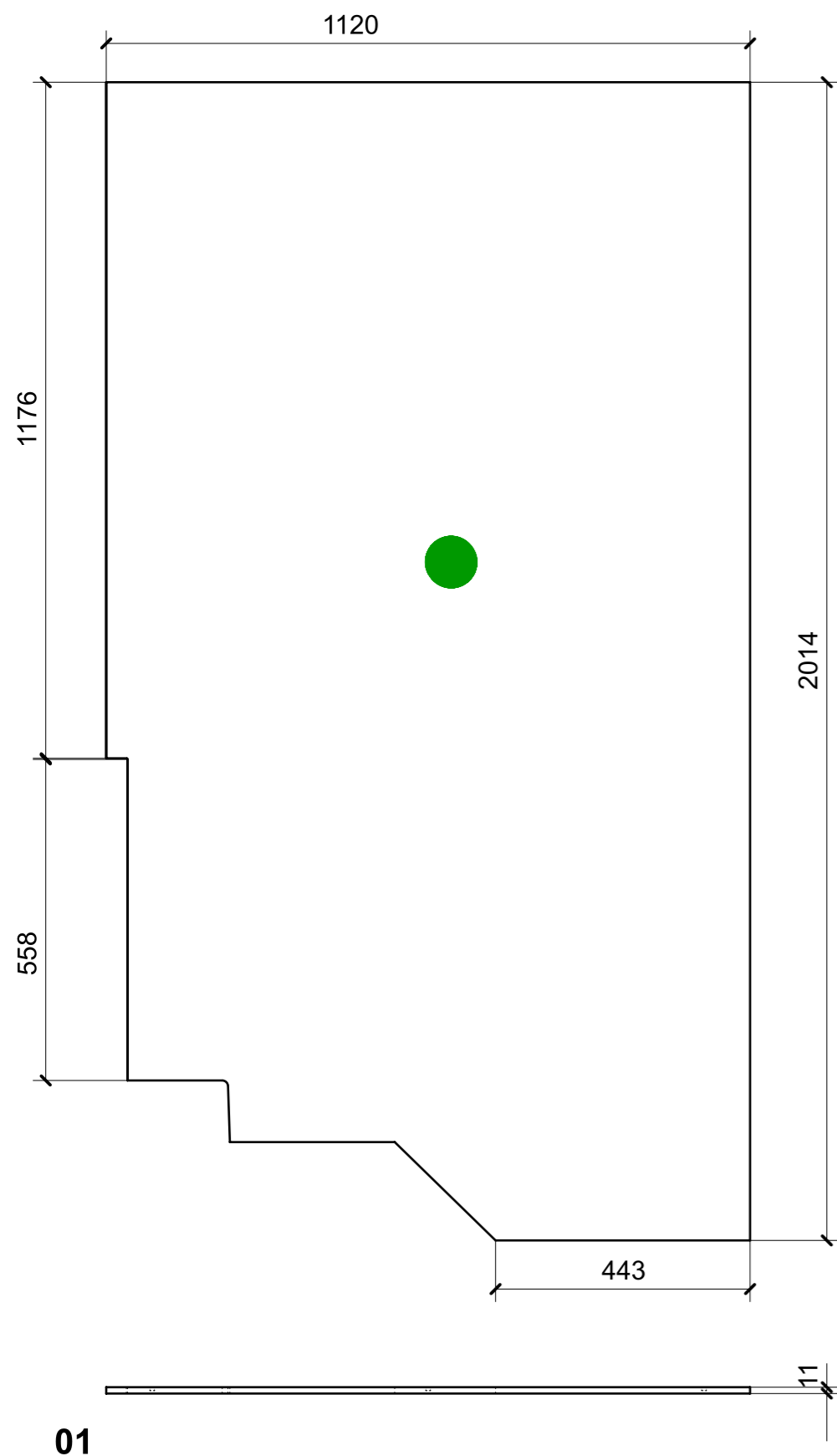

VERNICIATURA LASTRA/LACCATI:

● = VERNICIARE 1 LATO + FILI RASATI O BORDATI

NESSUN SIMBOLO = VERNICIARE 2 LATI + FILI RASATI O BORDATI

LOCALE	CODICE	DESCRIZIONE COMPONENTE	FINITURA	GR.
CABINA VIP	MD320_R01_VG01	RIVESTIMENTI PARETI CENTRO NAVE	LASTRA SCURA	3

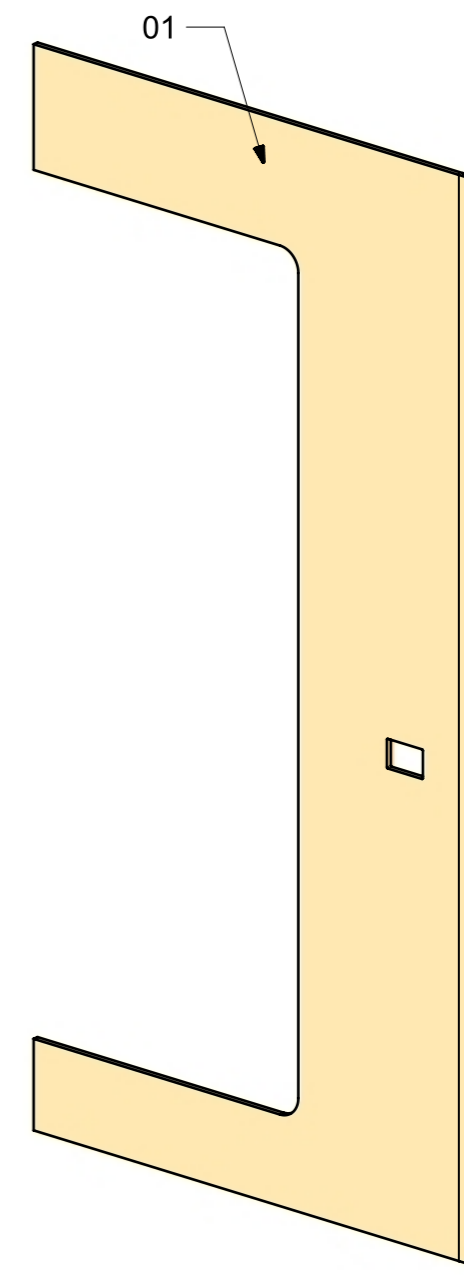
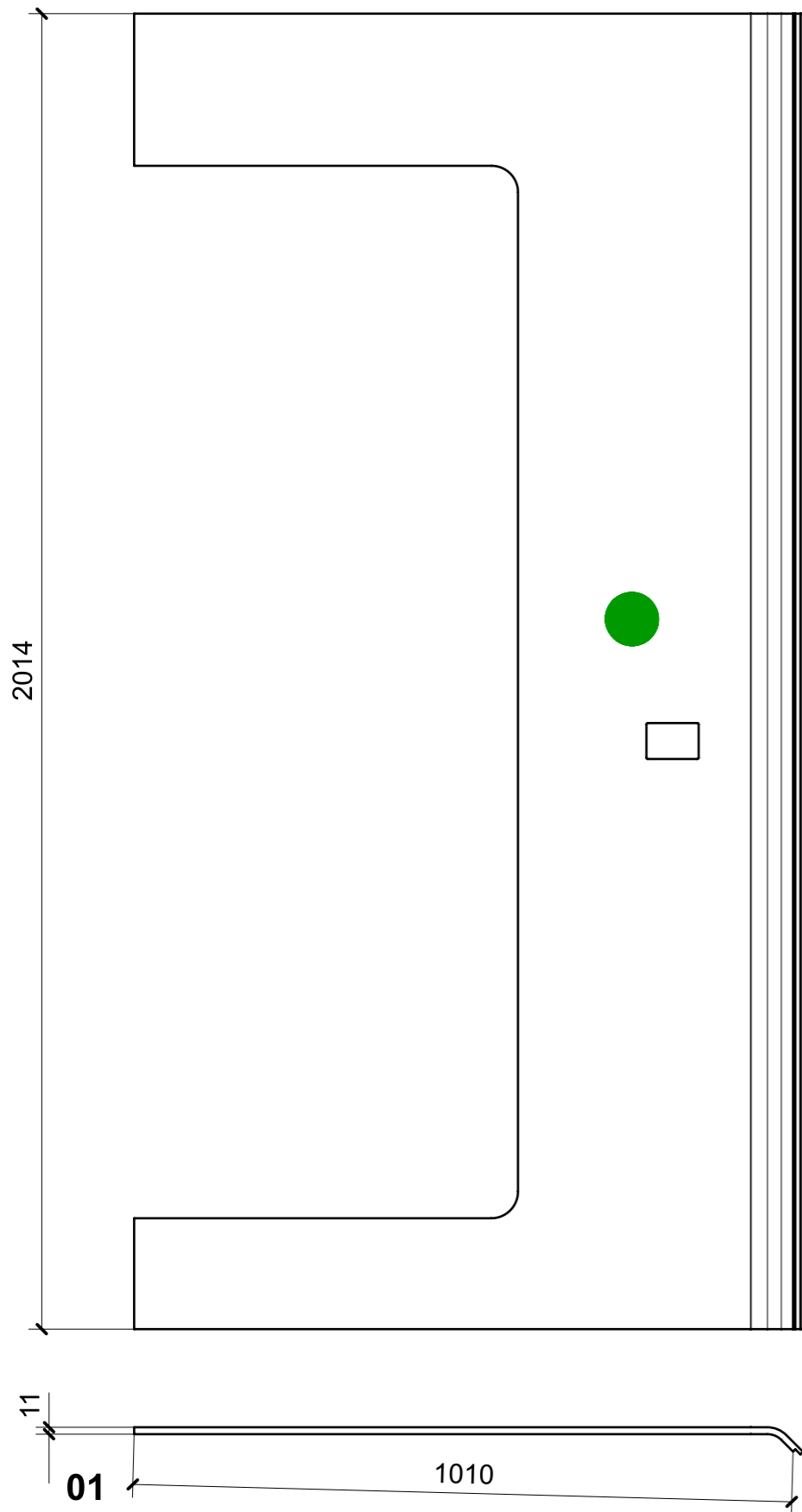

VERNICIATURA LASTRA/LACCATI:

● = VERNICIARE 1 LATO + FILI RASATI O BORDATI

NESSUN SIMBOLO = VERNICIARE 2 LATI + FILI RASATI O BORDATI

LOCALE	CODICE	DESCRIZIONE COMPONENTE	FINITURA	GR.
CABINA VIP	MD320_R02_VG01	RIVESTIMENTI PARETI CENTRO NAVE	LASTRA CHIARA	3

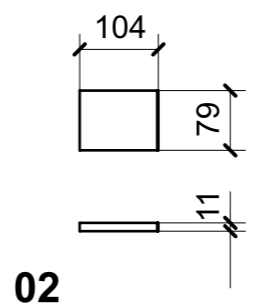
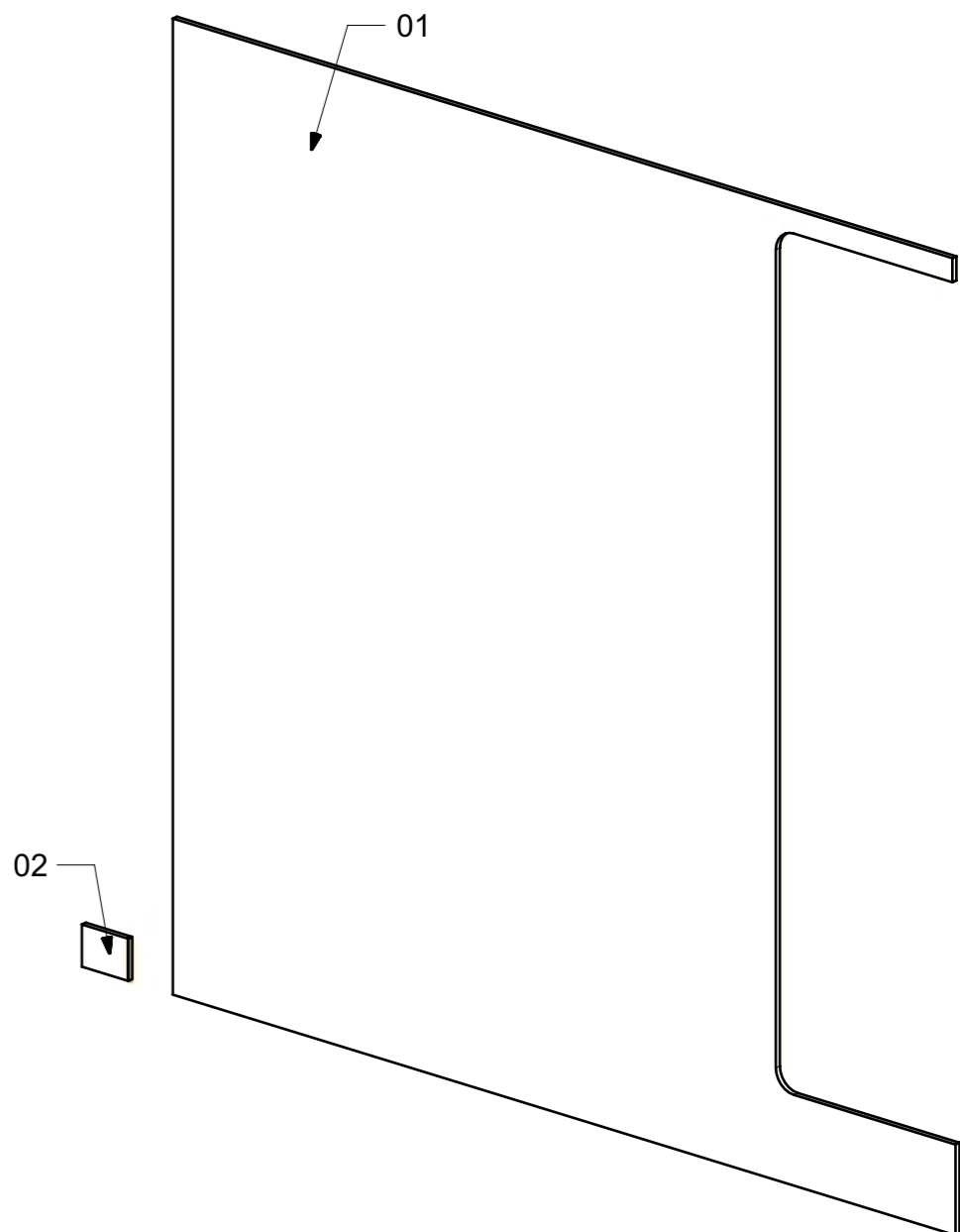
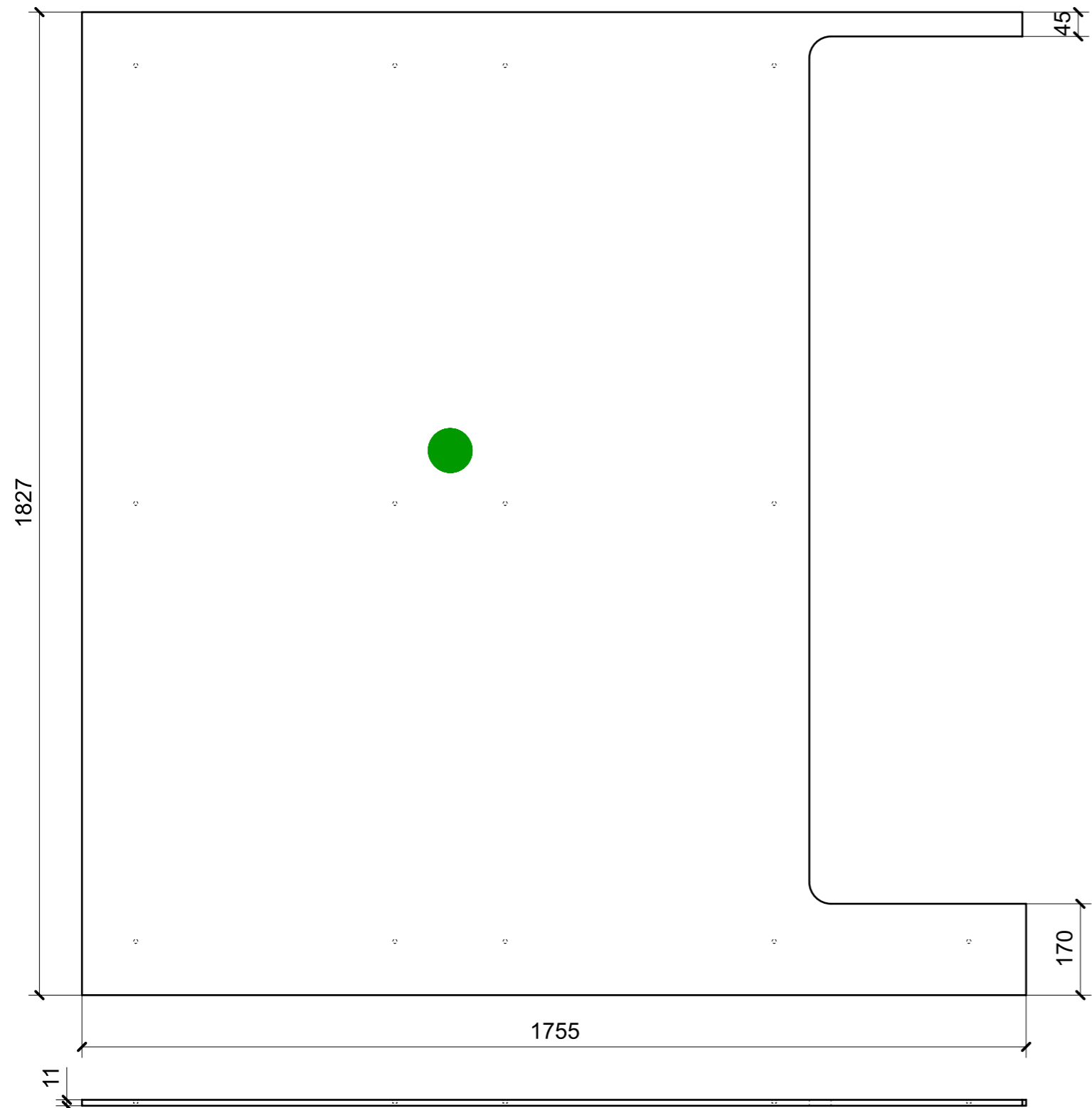

01

02

VERNICIATURA LASTRA/LACCATI:

● = VERNICIARE 1 LATO + FILI RASATI O BORDATI

NESSUN SIMBOLO = VERNICIARE 2 LATI + FILI RASATI O BORDATI

LOCALE	CODICE	DESCRIZIONE COMPONENTE	FINITURA	GR.
CABINA VIP DX	MD320_R02_VI01	ARMADIO	LASTRA CHIARA	PTP

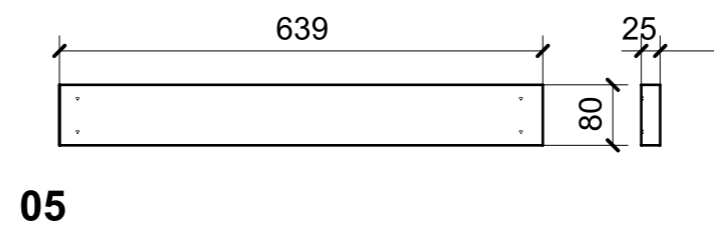
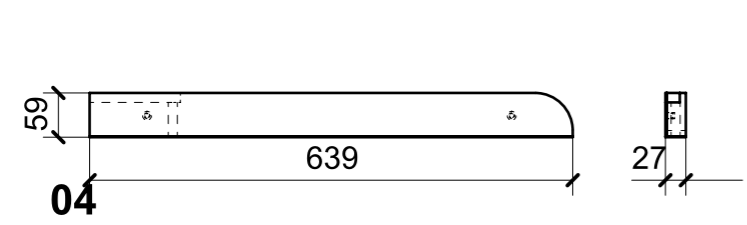
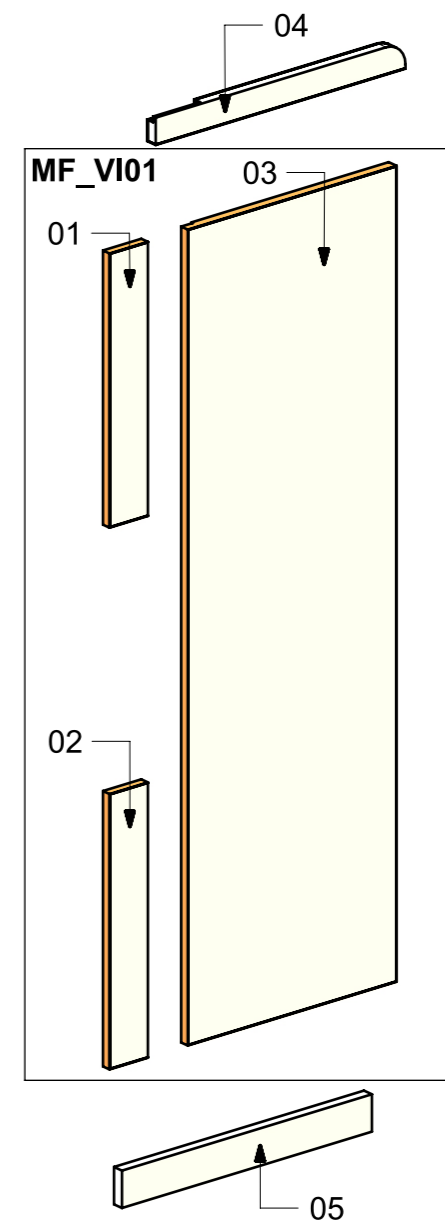
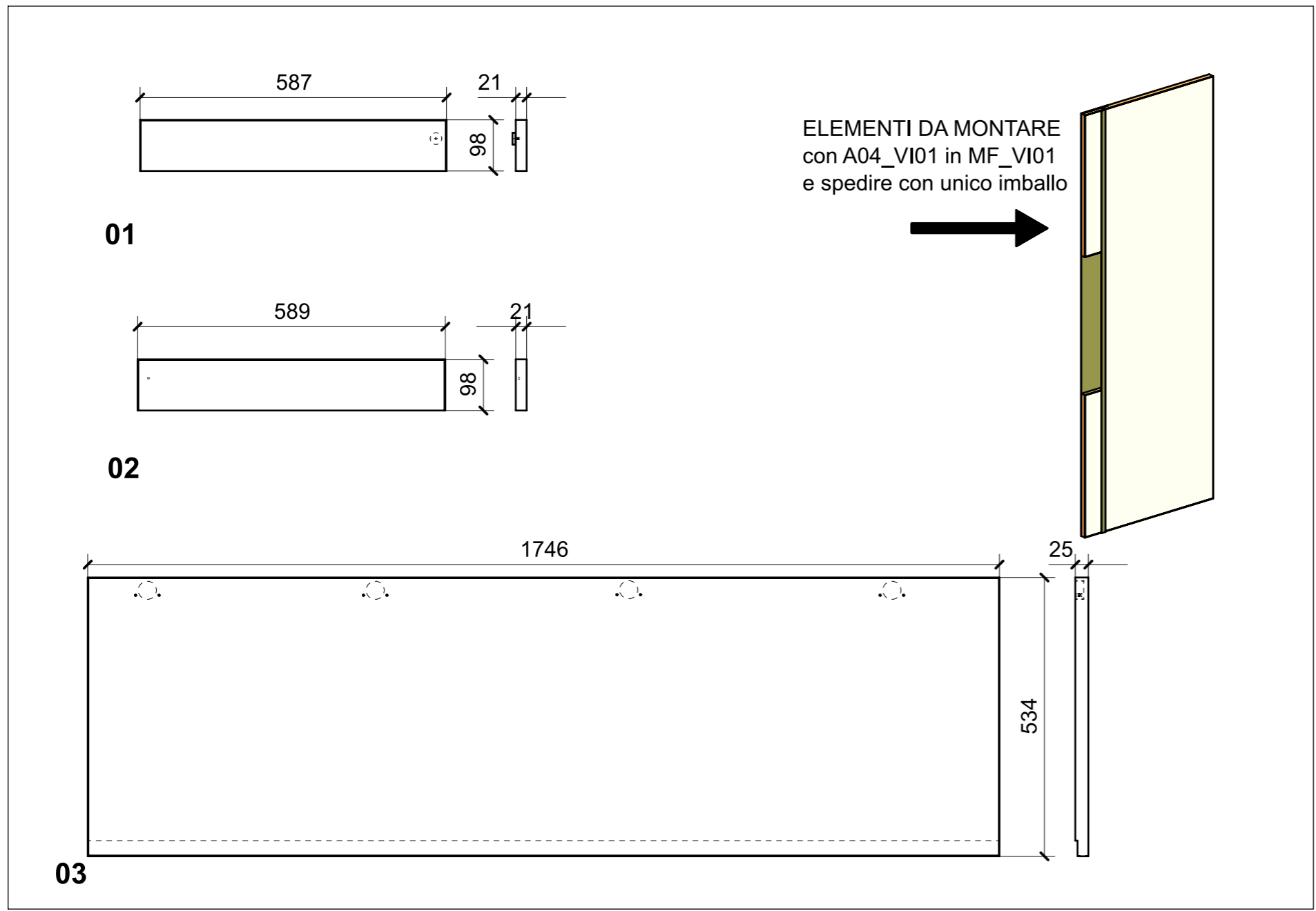

FERRAMENTA	QTY
BUSSOLA 5MA ANKOR BORGHI X CERNIERA PIANA	8
MAGNETE FORZA MAGNETICA1-5 10KG_HAFELE_246.87.112	1
BUSSOLA 6MA X 10 FORO DIAM.8	2

VERNICIATURA LASTRA/LACCATI:  
● = VERNICIARE 1 LATO + FILI RASATI O BORDATI      NESSUN SIMBOLO = VERNICIARE 2 LATI + FILI RASATI O BORDATI

LOCALE	CODICE	DESCRIZIONE COMPONENTE	FINITURA	GR.
CABINA VIP	MD320_R02_VL01	PLENUM ARMADIO	LASTRA CHIARA	2

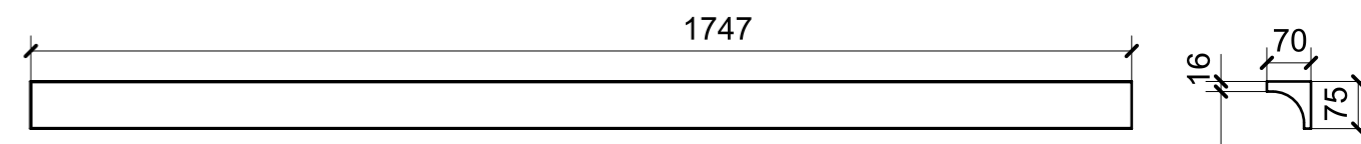
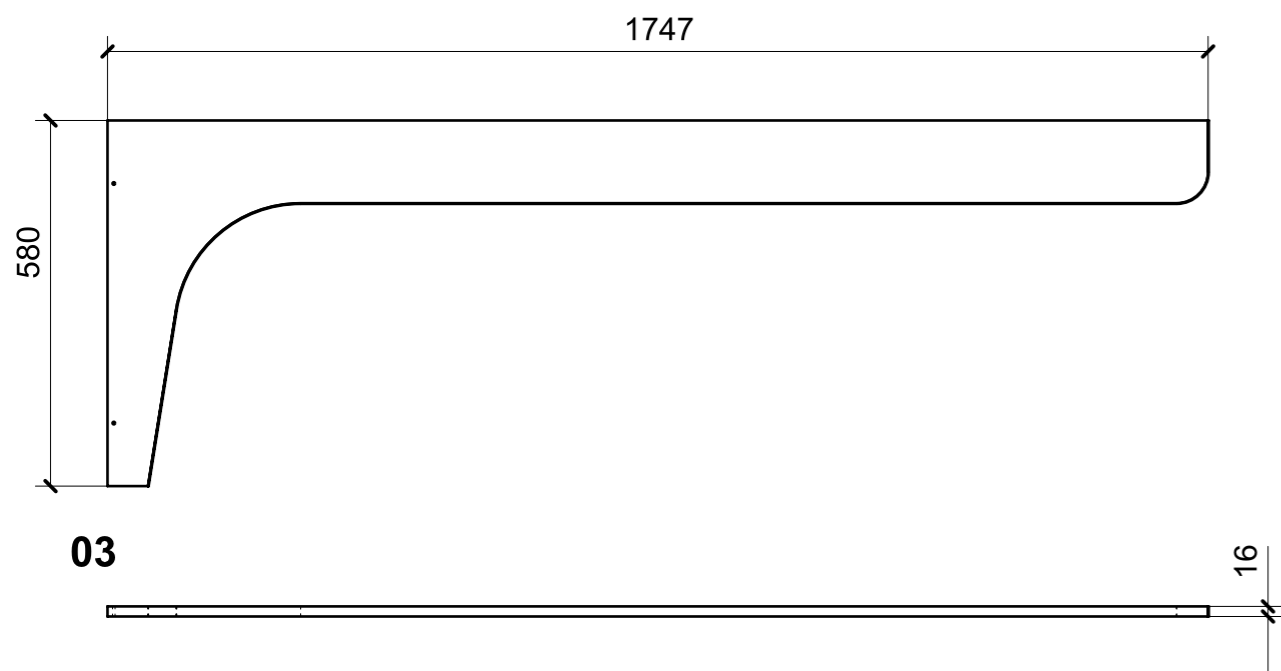

ELEMENTI DA MONTARE  
in MG\_VL02  
e spedire con unico imballo

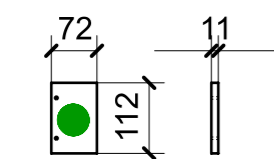
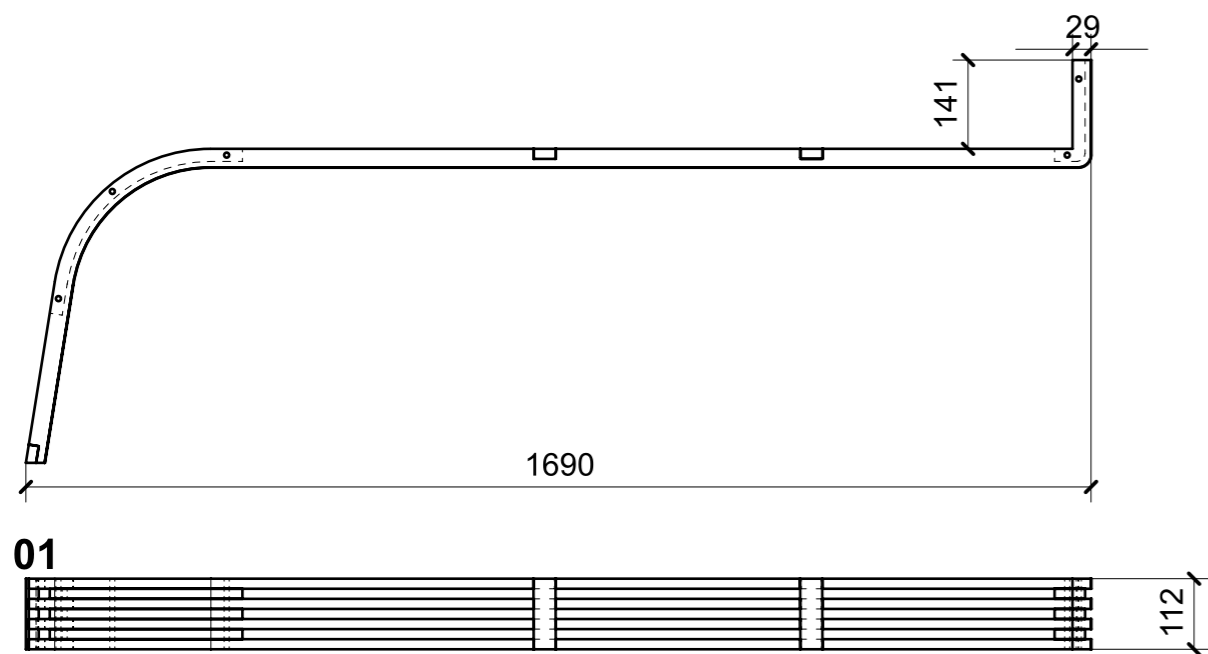
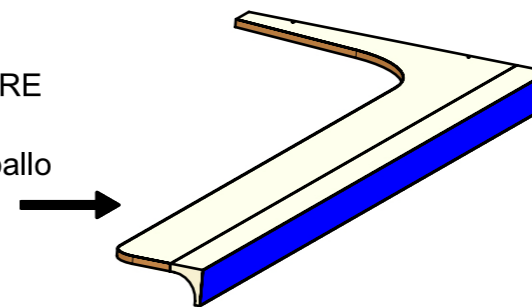

ELEMENTI DA MONTARE  
in MG\_VL01  
e spedire con unico imballo

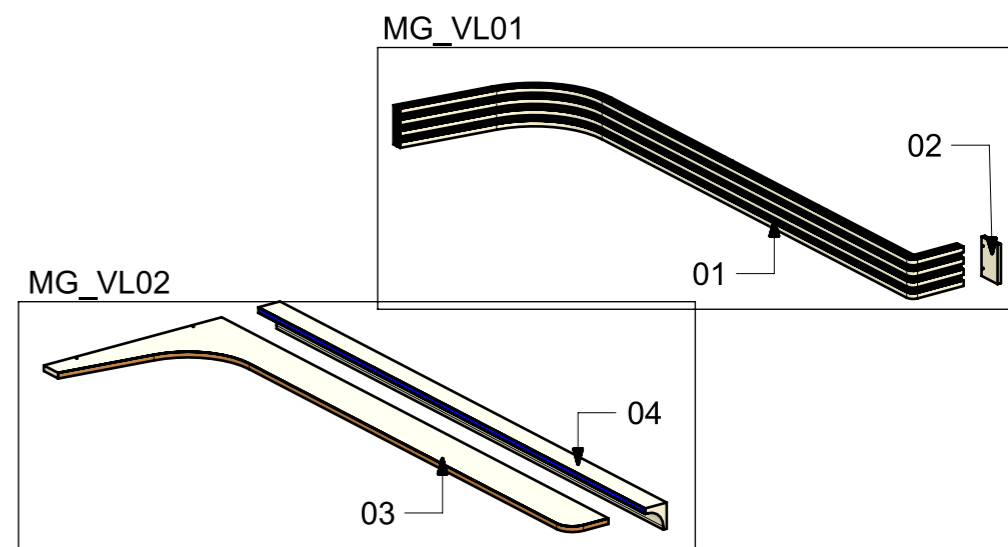
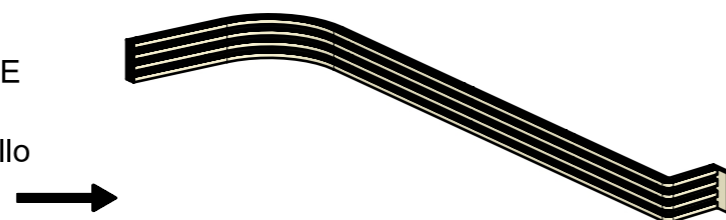

VERNICIATURA LASTRA/LACCATI:

● = VERNICIARE 1 LATO + FILI RASATI O BORDATI

NESSUN SIMBOLO = VERNICIARE 2 LATI + FILI RASATI O BORDATI