

LOCALE	CODICE	DESCRIZIONE COMPONENTE	FINITURA	GR
CABINA VIP SX	MD320_X01_VVA01	STRUTTURA MURATA TESTATA LETTO	LAMINATO SM'ART 3096 BIANCO LACCATO	3

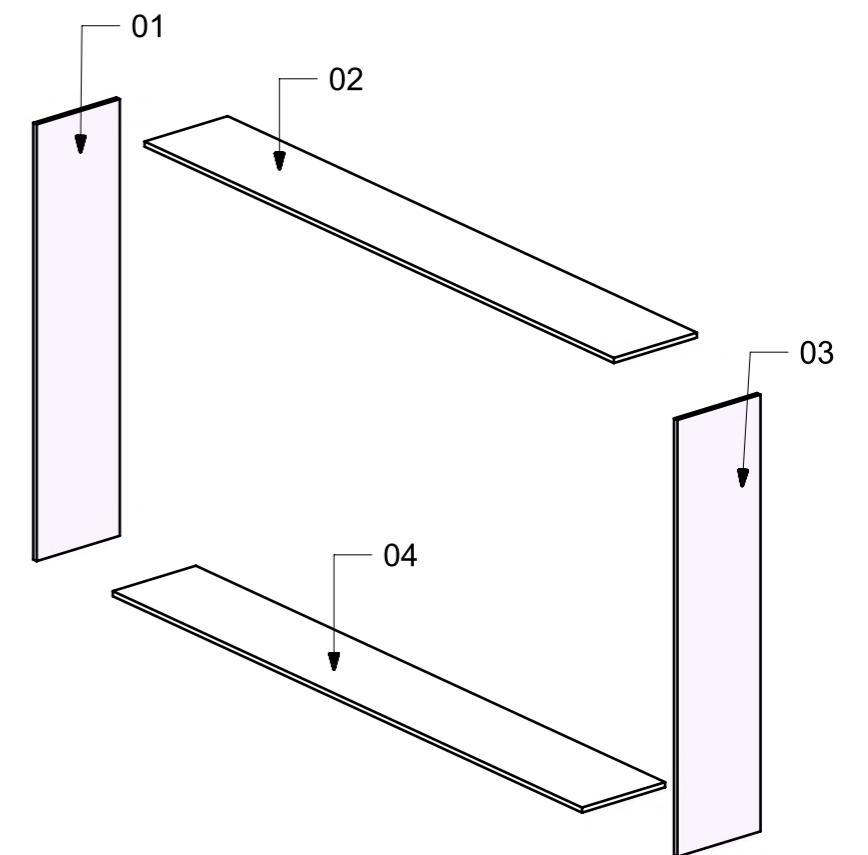

LOCALE	CODICE	DESCRIZIONE COMPONENTE	FINITURA	Q.TA
CABINA VIP SX	MD320_X01_VVB01	COMODINO PRUA	LAMINATO SMART RE13 FIRMAMENTO REVERSO	2

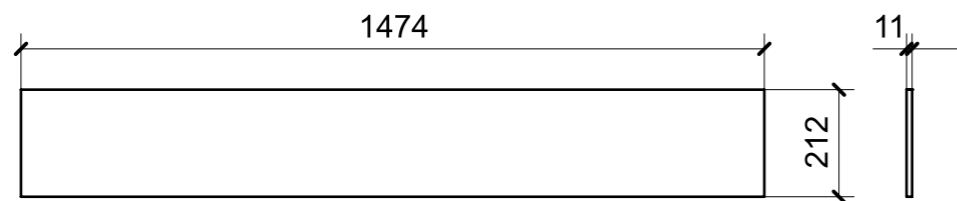
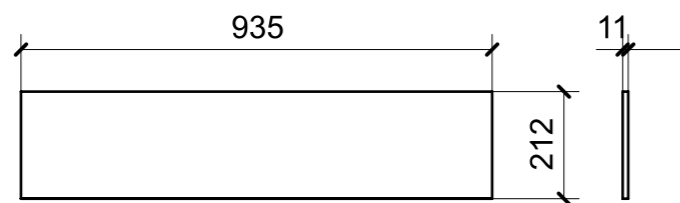
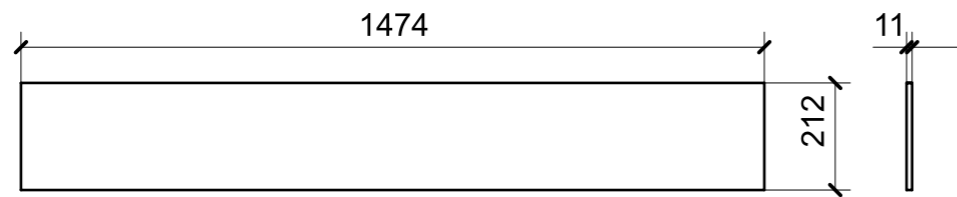
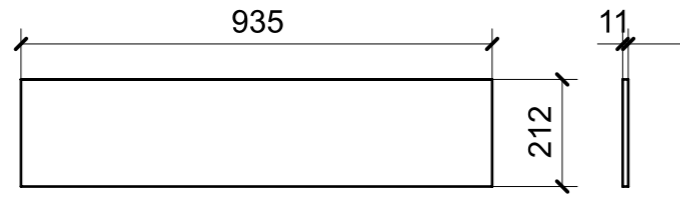
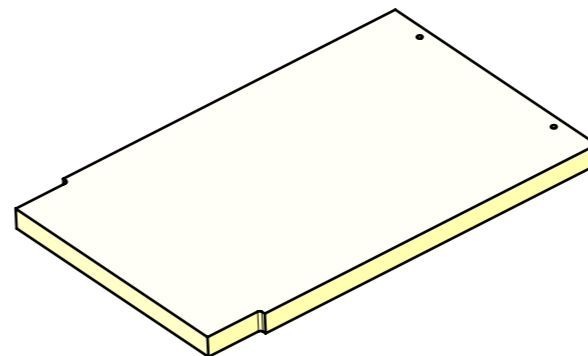
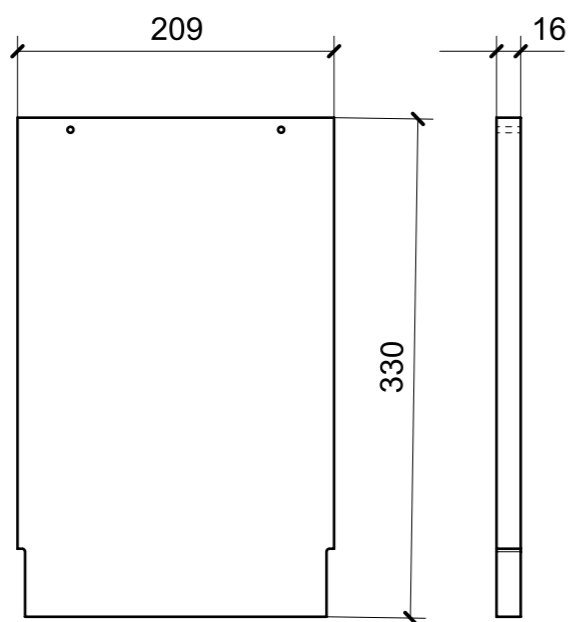

LOCALE	CODICE	DESCRIZIONE COMPONENTE	FINITURA	Q.TA
CABINA VIP SX	MD320_I01_VVD01	COMODINO POPPA	LAMINATO SMART RE13 FIRMAMENTO REVERSO	2

