

LOCALE	CODICE	DESCRIZIONE COMPONENTE	FINITURA	GR.
CABINA VIP	MD320_X01_VA01	STRUTTURA MURATA TESTATA LETTO	LAMINATO SM'ART 3096 BIANCO LACCATO	3

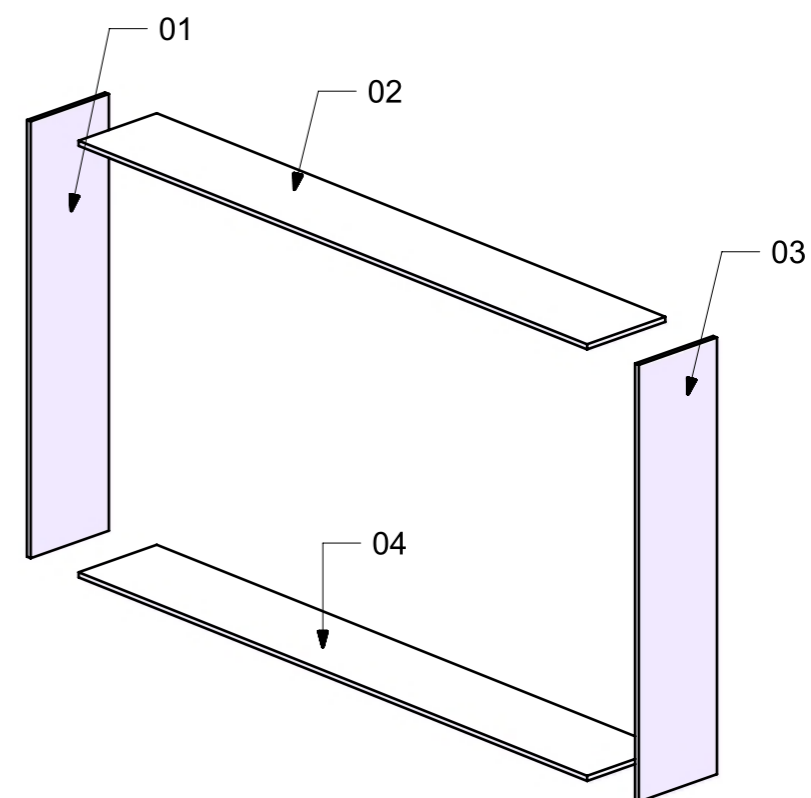

LOCALE	CODICE	DESCRIZIONE COMPONENTE	FINITURA	GR.
CABINA VIP	MD320_X01_VB01	COMODINO PRUA	LAMINATO SMART RE13 FIRMAMENTO REVERSO	2

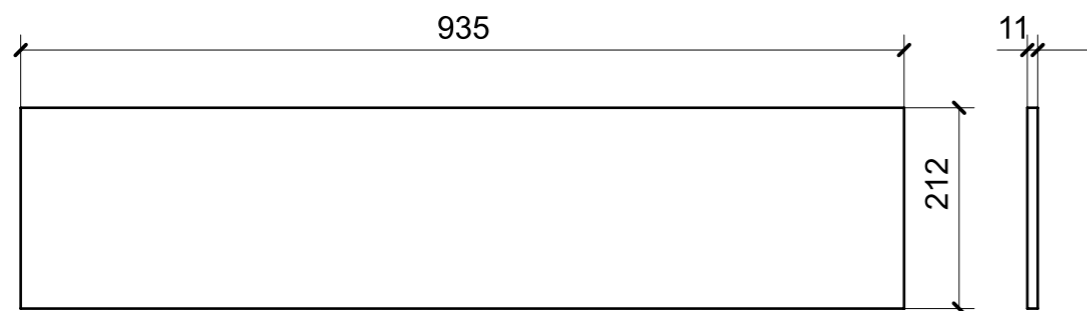
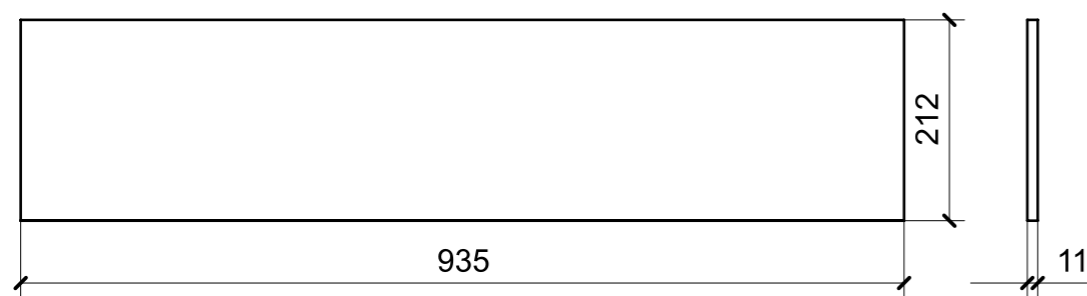
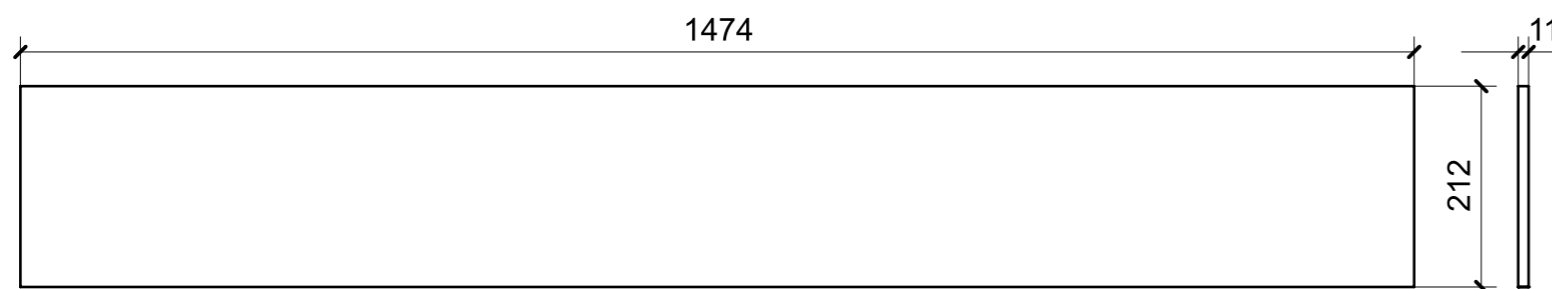
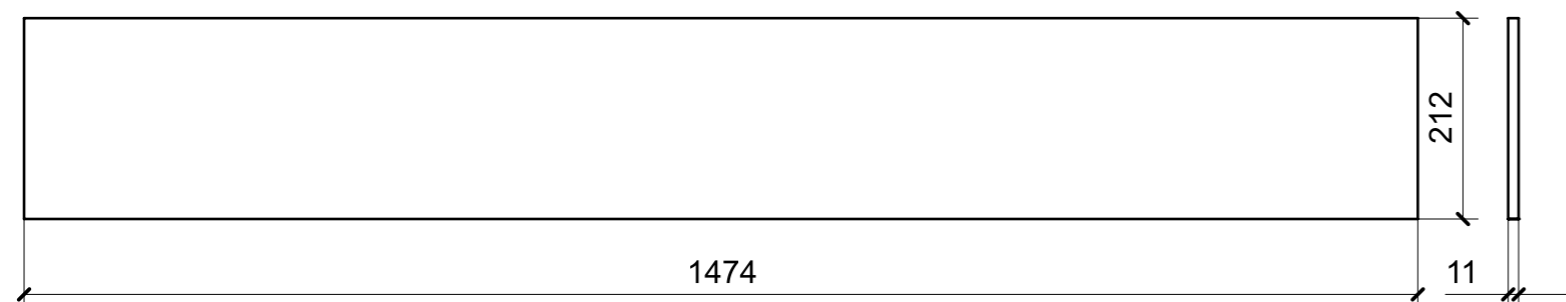
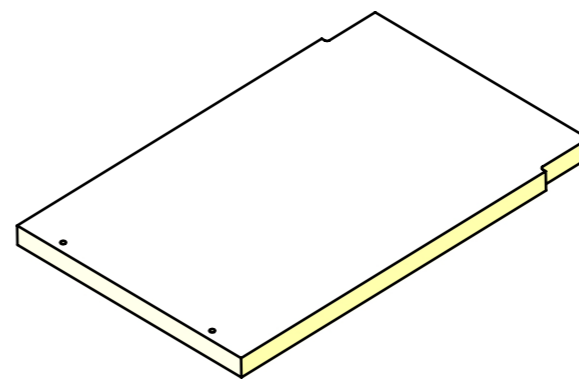
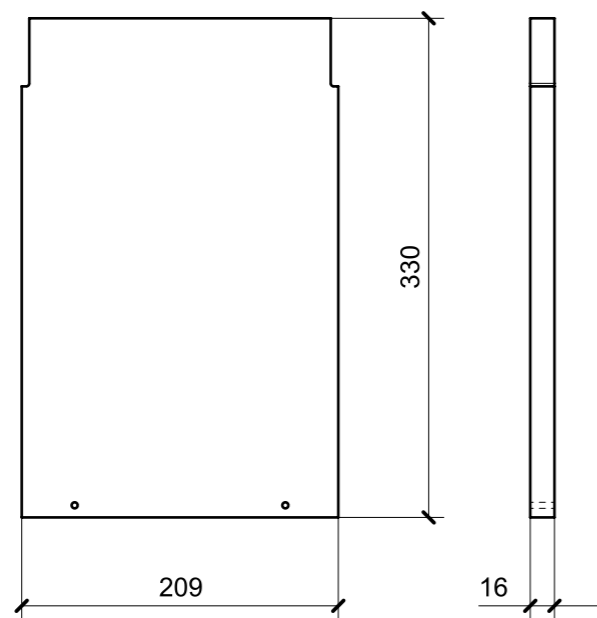

LOCALE	CODICE	DESCRIZIONE COMPONENTE	FINITURA	GR.
CABINA VIP	MD320_X01_VD01	COMODINO POPPA	LAMINATO SMART RE13 FIRMAMENTO REVERSO	2

