

LOCALE	CODICE	DESCRIZIONE COMPONENTE	FINITURA	GR
CABINA VIP SX	MD320_I01_VVA01	STRUTTURA MURATA TESTATA LETTO	OKUME' GREZZO	3

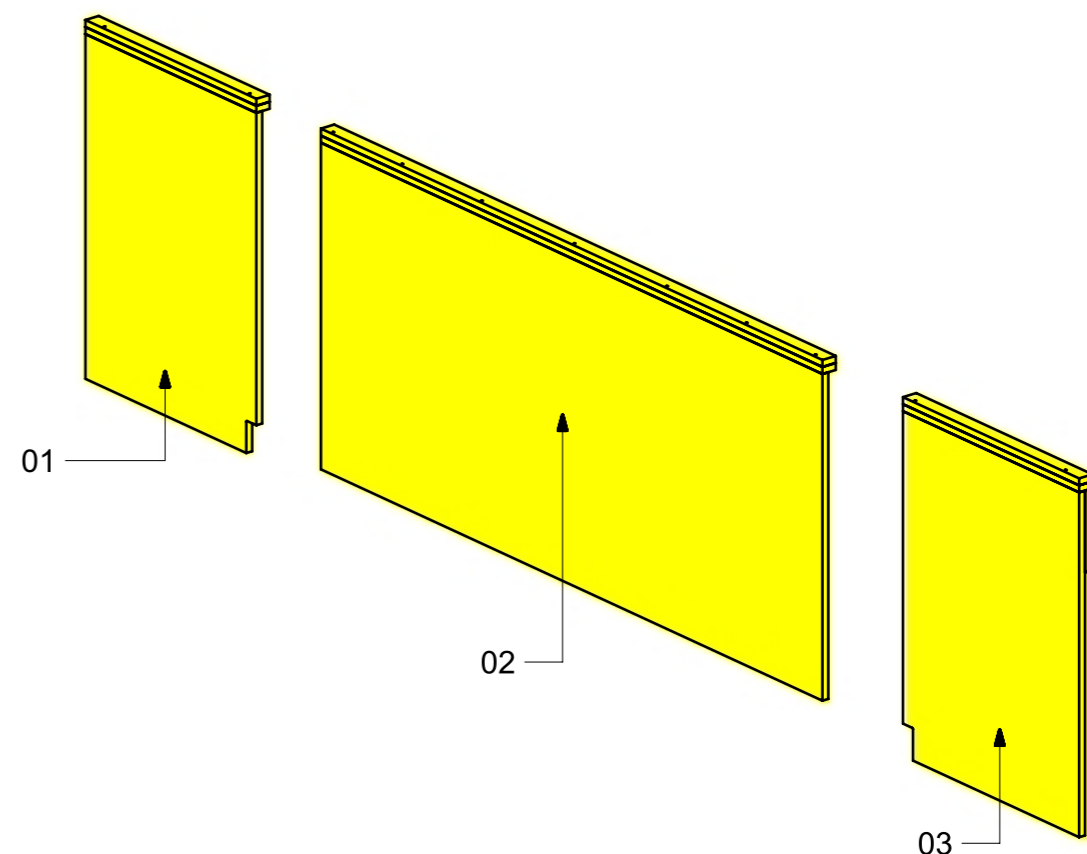

FERRAMENTA	QTY
FITLOCK M_MASCHERPA_3MM_6020202101	16

LOCALE	CODICE	DESCRIZIONE COMPONENTE	FINITURA	Q.TA
CABINA VIP SX	MD320_I01_VVB01	COMODINO PRUA	OKUME' GREZZO	2

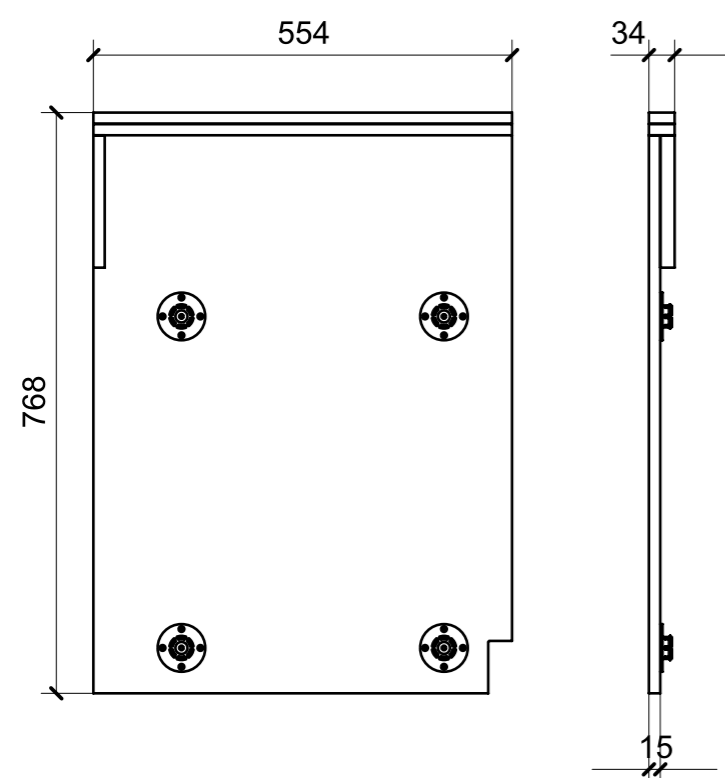
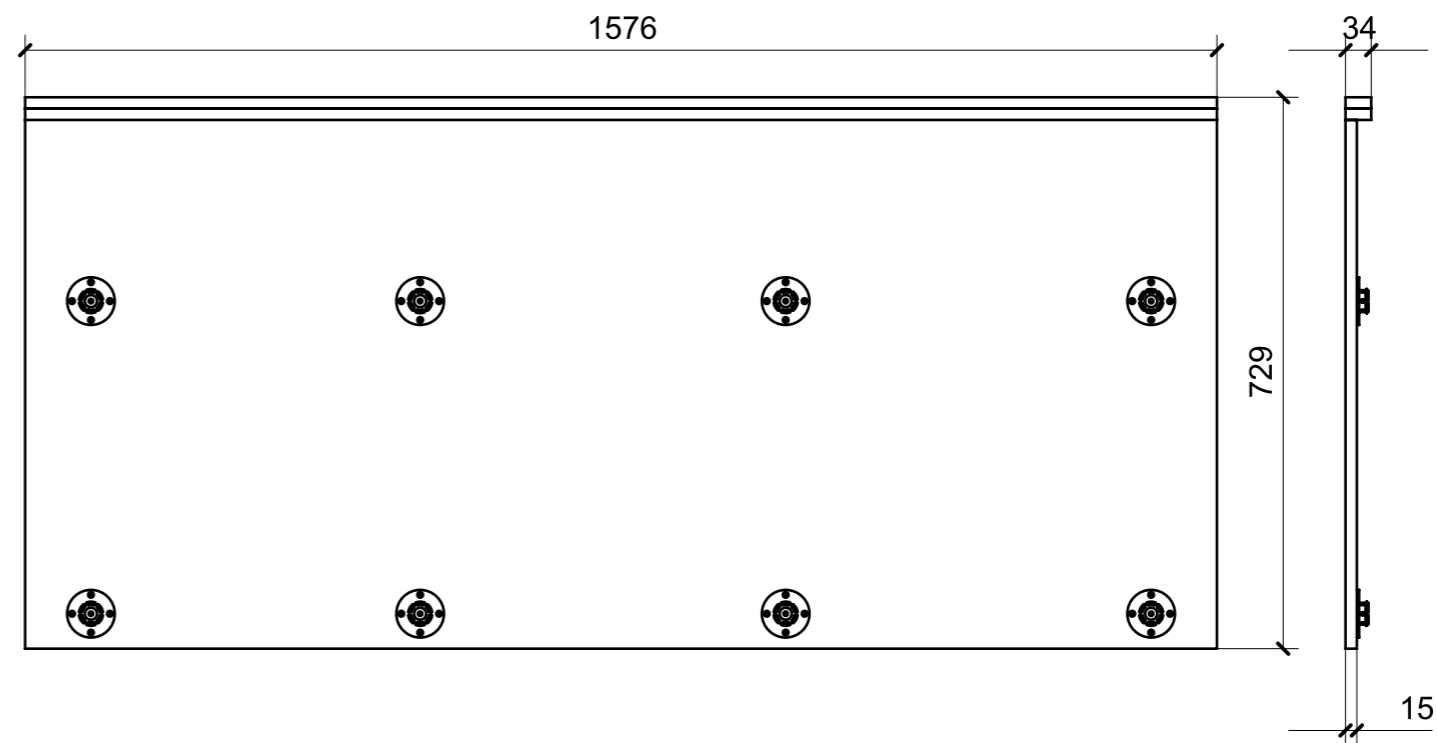
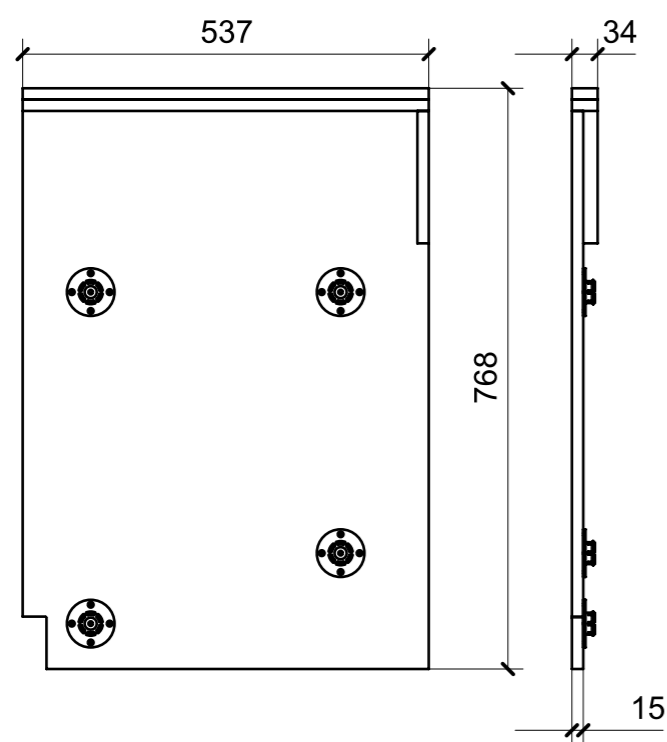
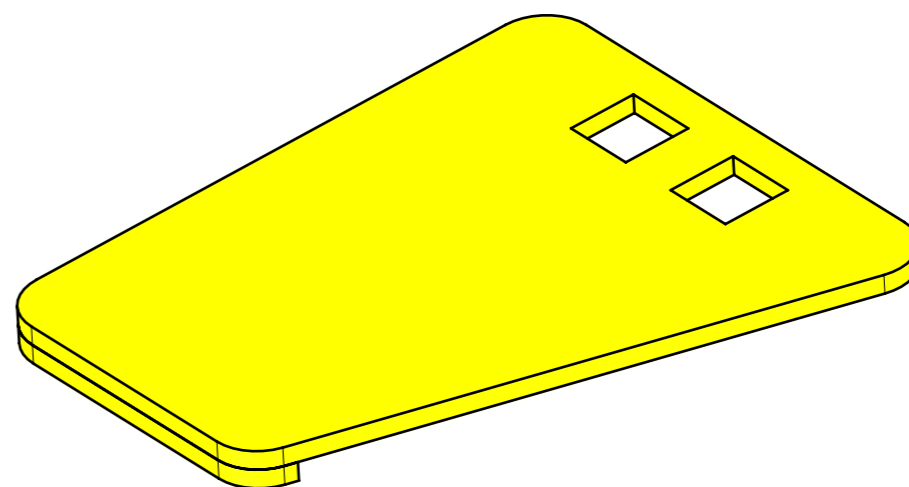
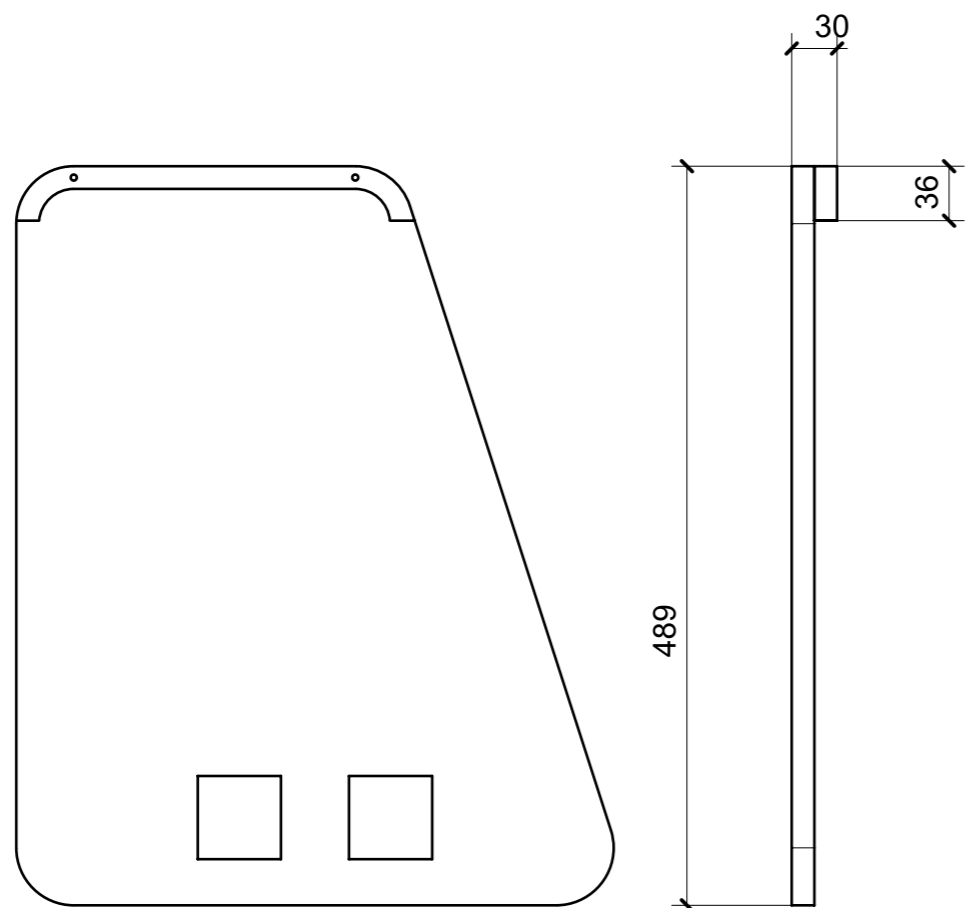

LOCALE	CODICE	DESCRIZIONE COMPONENTE	FINITURA	Q.TA
CABINA VIP SX	MD320_I01_VVC01	STRUTTURA LETTO	OKUME' GREZZO	PTP

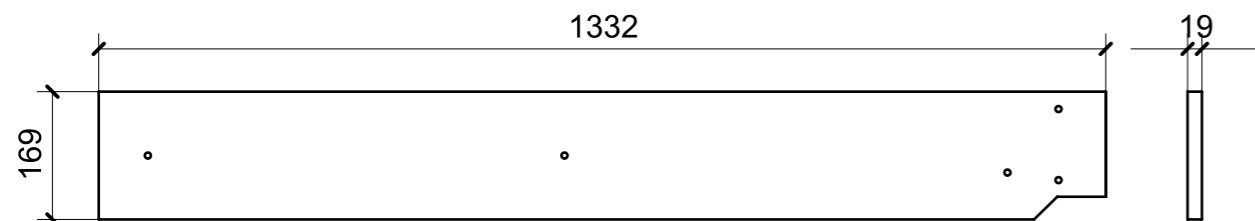

01

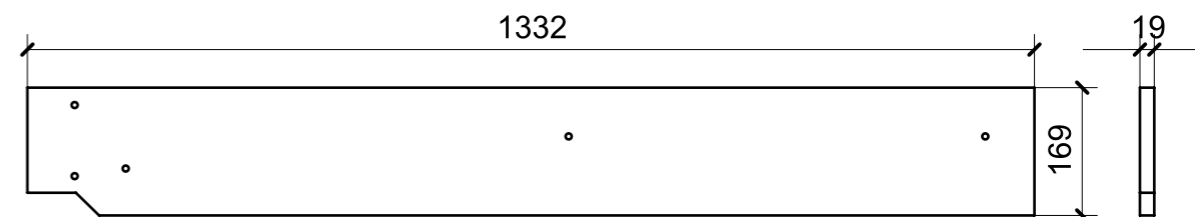

03

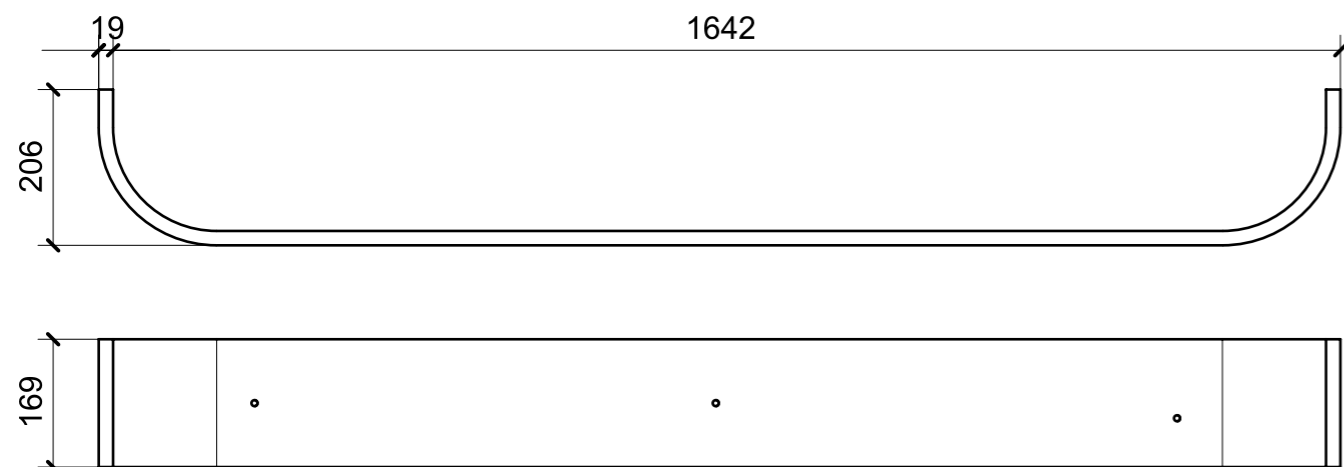

02

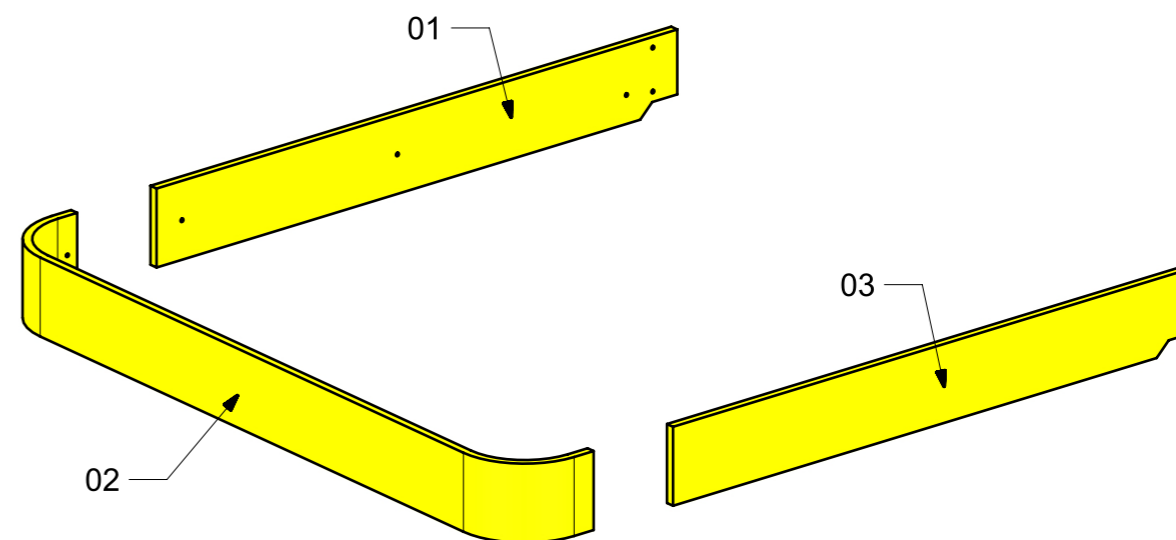

LOCALE	CODICE	DESCRIZIONE COMPONENTE	FINITURA	Q.TA
CABINA VIP SX	MD320_I01_VVD01	COMODINO POPPA	OKUME' GREZZO	2

