

LOCALE	CODICE	DESCRIZIONE COMPONENTE	FINITURA	GR.
LOBBY LD	MD320_A09_CA01	SCALA	ACCIAIO GREZZO	2

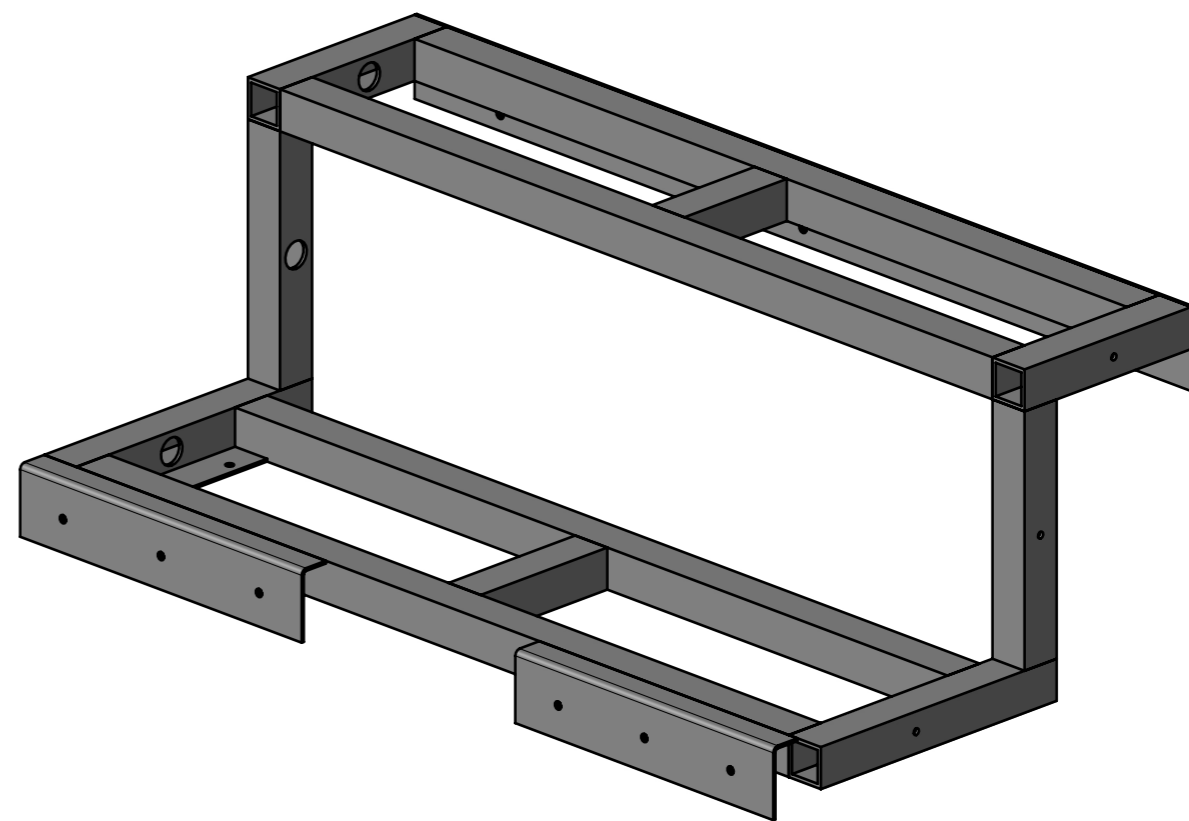
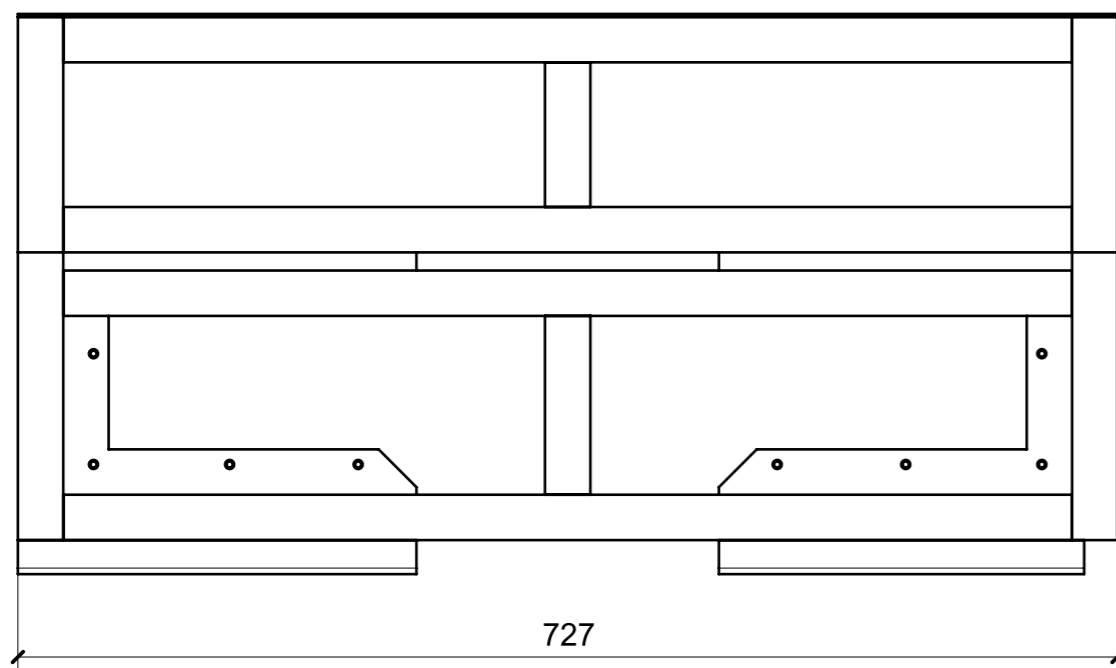
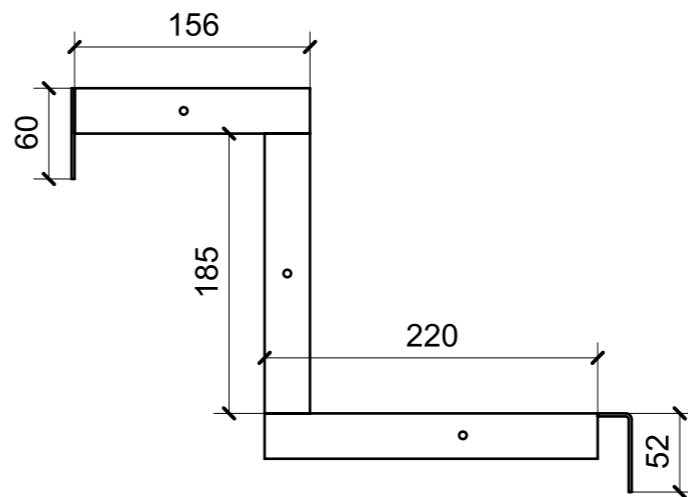
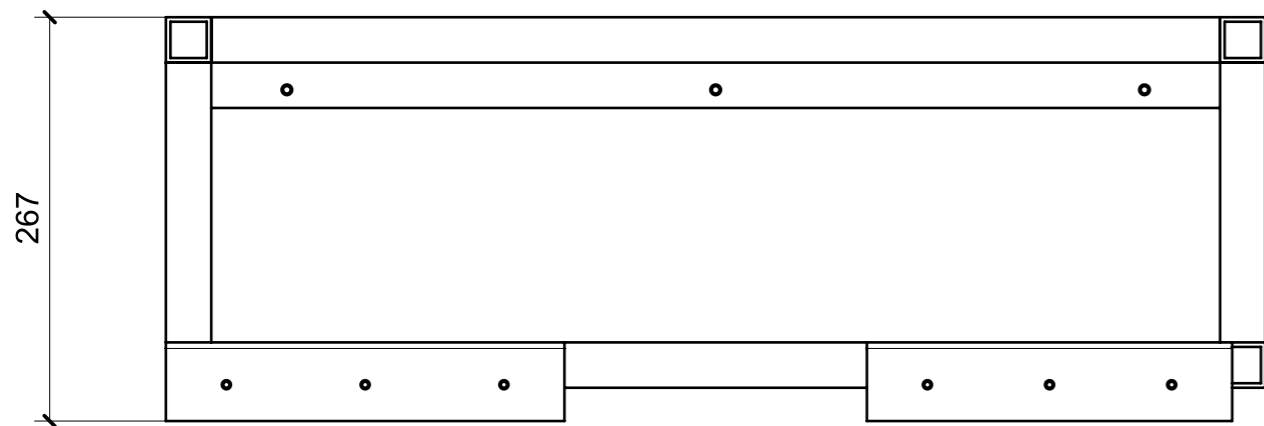

VERNICIATURA LASTRA/LACCATI:

● = FILI RASATI

● = VERNICIARE 1 LATO + FILI RASATI O BORDATI

NESSUN SIMBOLO = VERNICIARE 2 LATI + FILI RASATI O BORDATI

LOCALE	CODICE	DESCRIZIONE COMPONENTE	FINITURA	GR.
LOBBY LD	MD320_A10_CB01	RIVESTIMENTI POPPA DX	ACCIAIO GREZZO	2

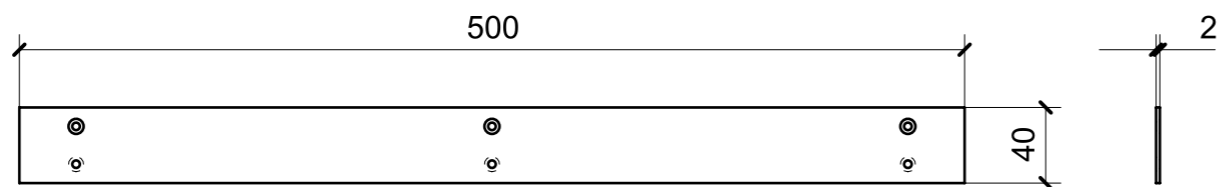

A10_01

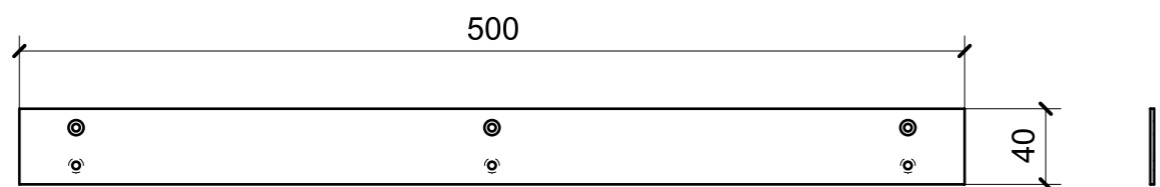

A10_02

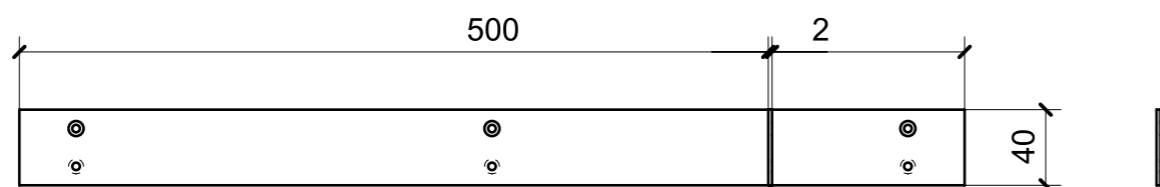

A10_03

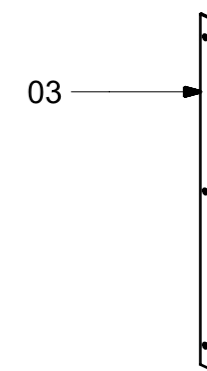
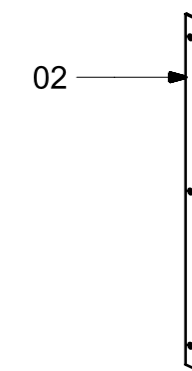
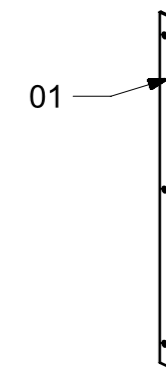

LOCALE	CODICE	DESCRIZIONE COMPONENTE	FINITURA	GR.
LOBBY LD	MD320_A10_CE01	RIVESTIMENTI POPPA SX	ACCIAIO GREZZO	3

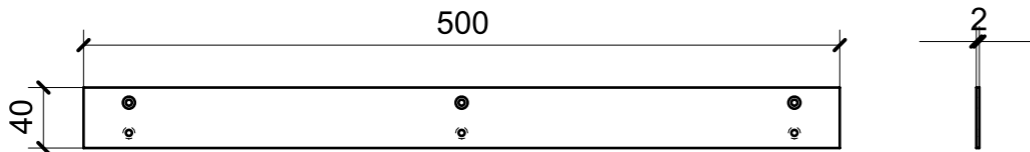

A10_CE01_01

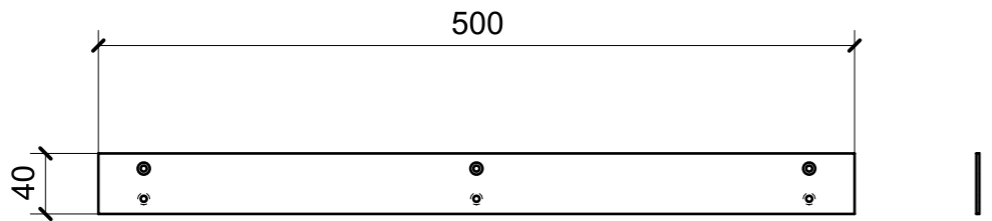

A10_CE01_02

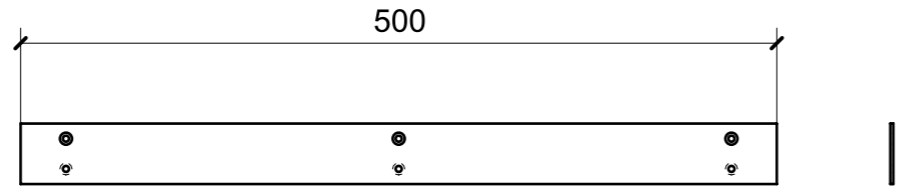

A10_CE01_03

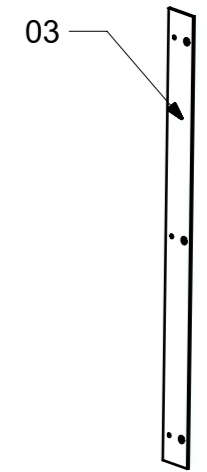
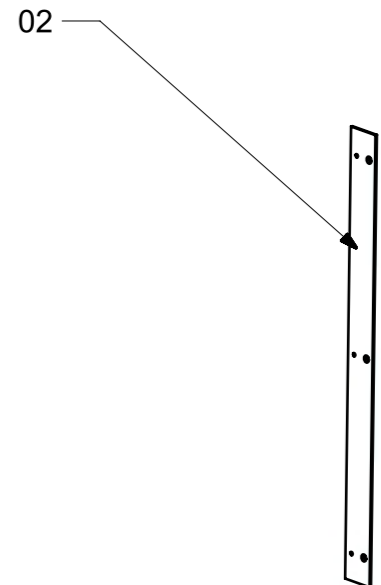
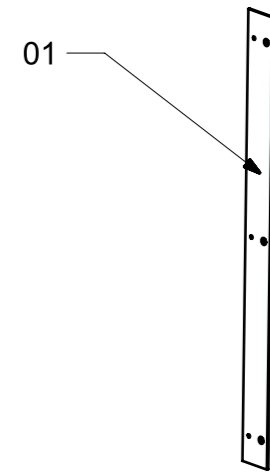

LOCALE	CODICE	DESCRIZIONE COMPONENTE	FINITURA	GR.
LOBBY LD	MD320_A11-A12_CF01	RIVESTIMENTI PRUA SX	ALLUMINIO VERNICIATO BRONZO	3

A12

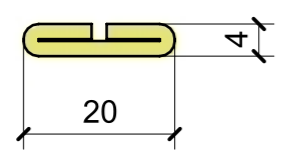
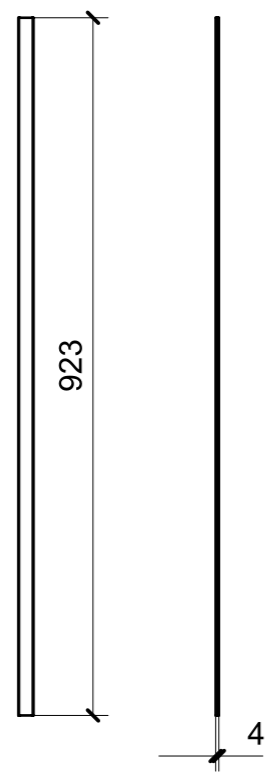

A11

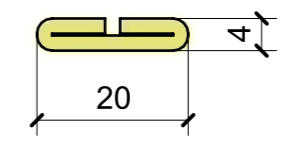
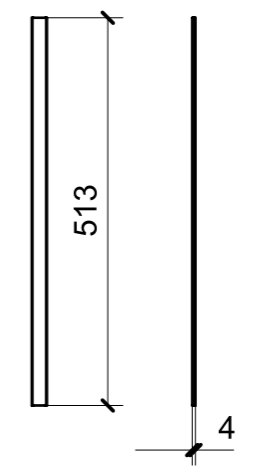

LOCALE	CODICE	DESCRIZIONE COMPONENTE	FINITURA	GR.
LOBBY LD	MD320_A13_CH01	MOBILE QUADRO ELETTRICO	ALLUMINIO VERNICIATO BRONZO	2

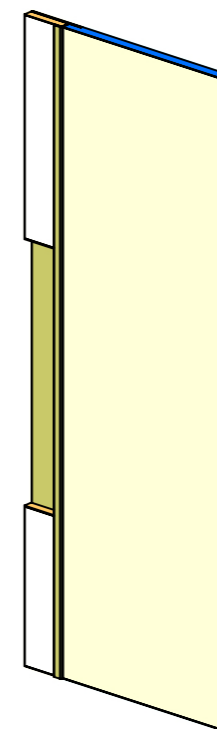
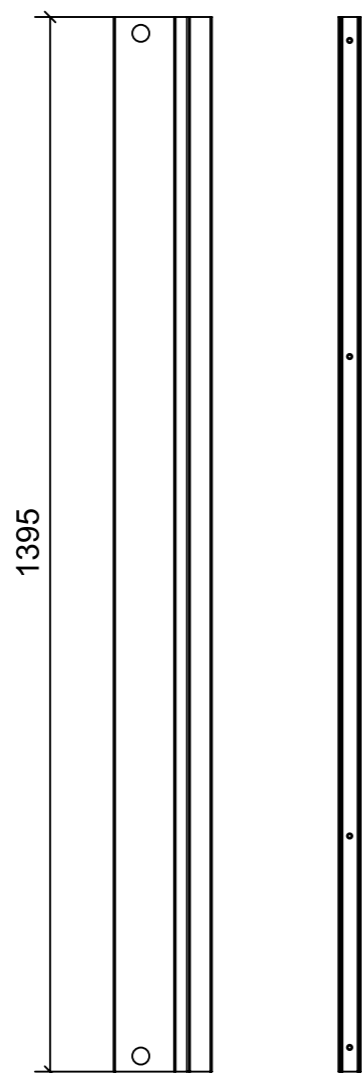

ELEMENTO DA MONTARE
in MF_CH01
e spedire con unico imballo

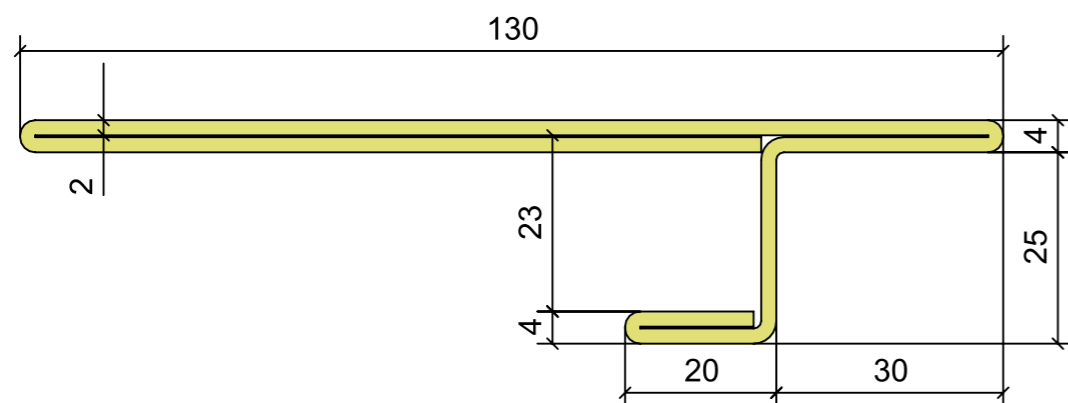

LOCALE	CODICE	DESCRIZIONE COMPONENTE	FINITURA	GR.
LOBBY LD	MD320_A10_CM01	CIELINO DISCESA SCALE LUNGONAVE	ACCIAIO GREZZO	PTP

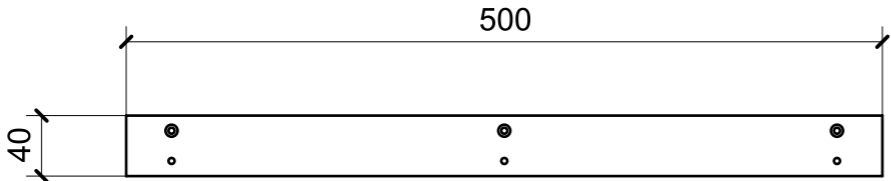
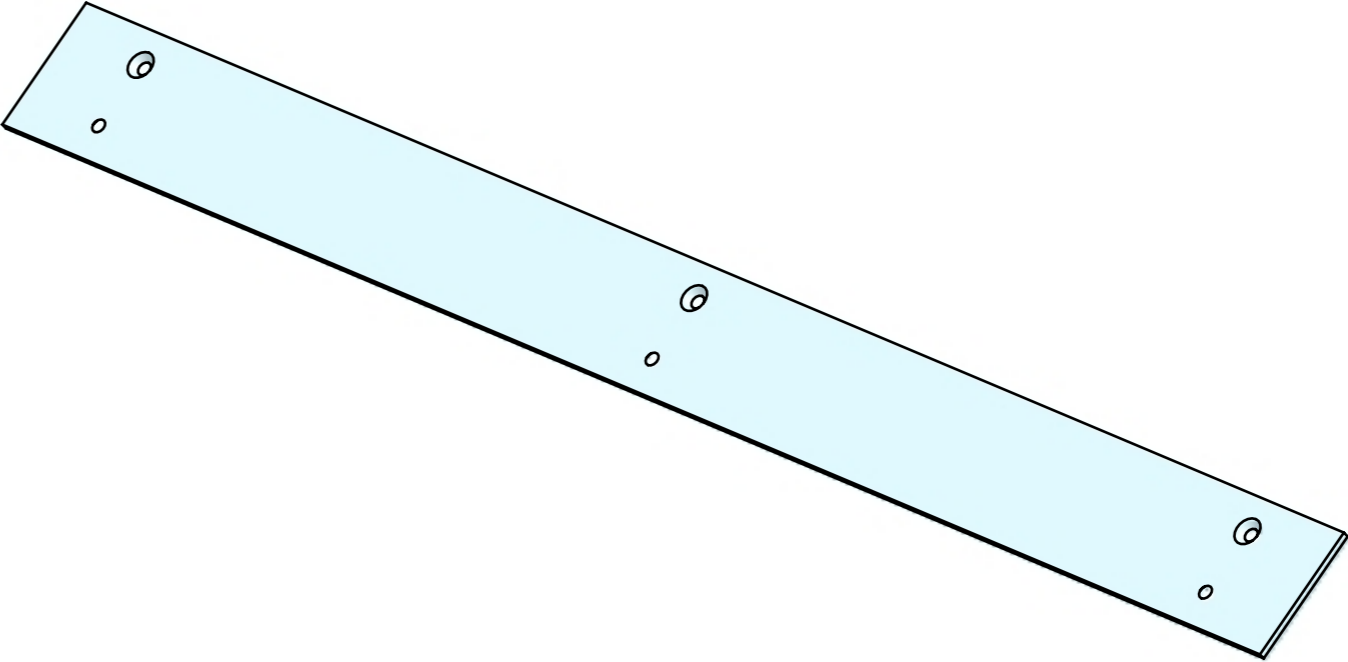

LOCALE	CODICE	DESCRIZIONE COMPONENTE	FINITURA	GR.
LOBBY LD	MD320_A10_CN01	CIELINO DISCESA SCALE TRAVERSONAVE	ACCIAIO GREZZO	3

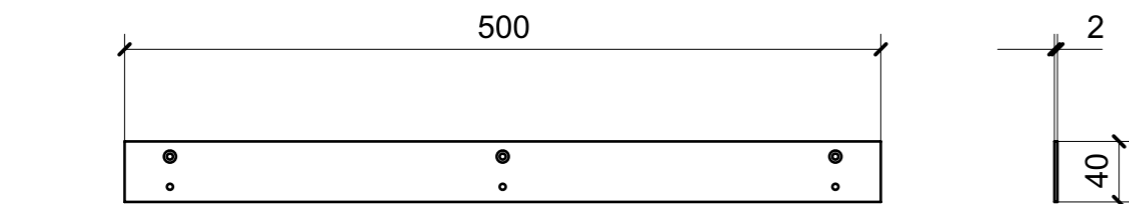

01

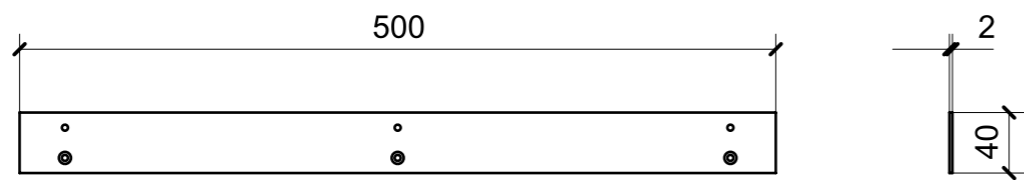

02

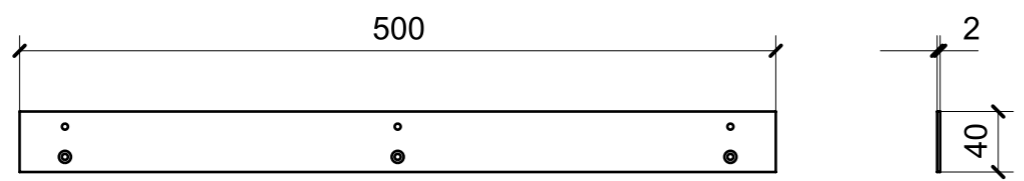

03

