

LOCALE	CODICE	DESCRIZIONE COMPONENTE	FINITURA	GR.
CABINA ARMATORE	MD320_MF_AA01	ARMADIO INGRESSO DX POPPA		2

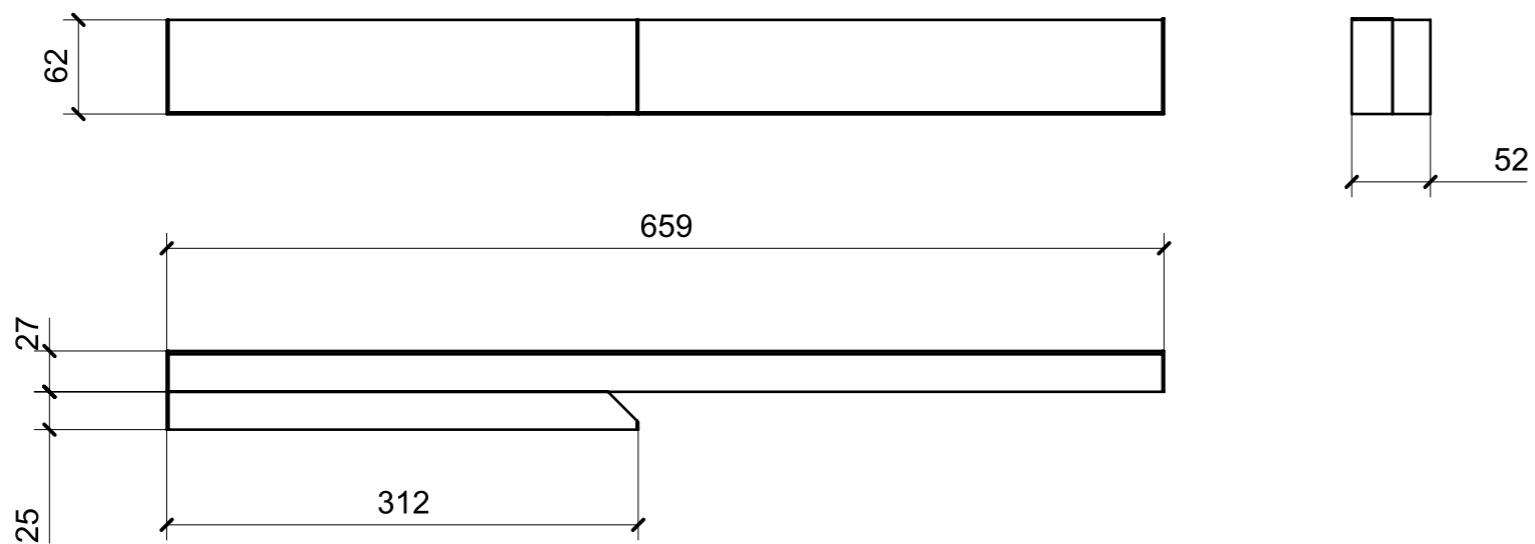
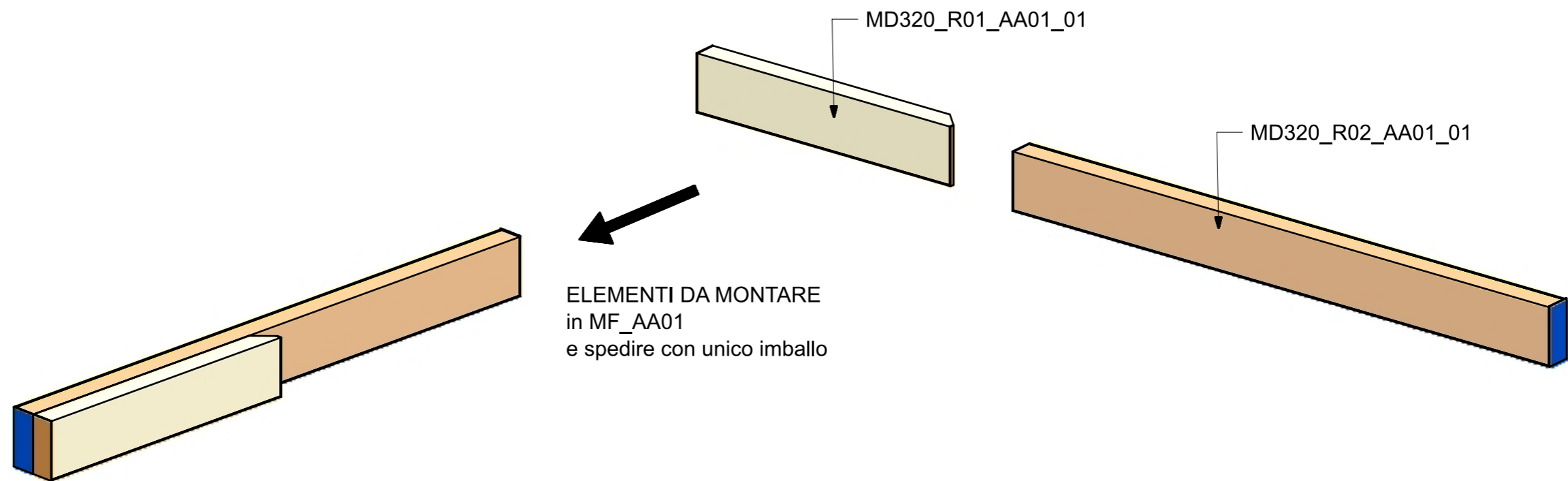

VERNICIATURA LASTRA/LACCATI:

● = FILI RASATI

● = VERNICIARE 1 LATO + FILI RASATI O BORDATI

NESSUN SIMBOLO = VERNICIARE 2 LATI + FILI RASATI O BORDATI

LOCALE	CODICE	DESCRIZIONE COMPONENTE	FINITURA	GR.
CABINA ARMATORE	MD320_MF_AB01	ARMADIO INGRESSO SX POPPA		2

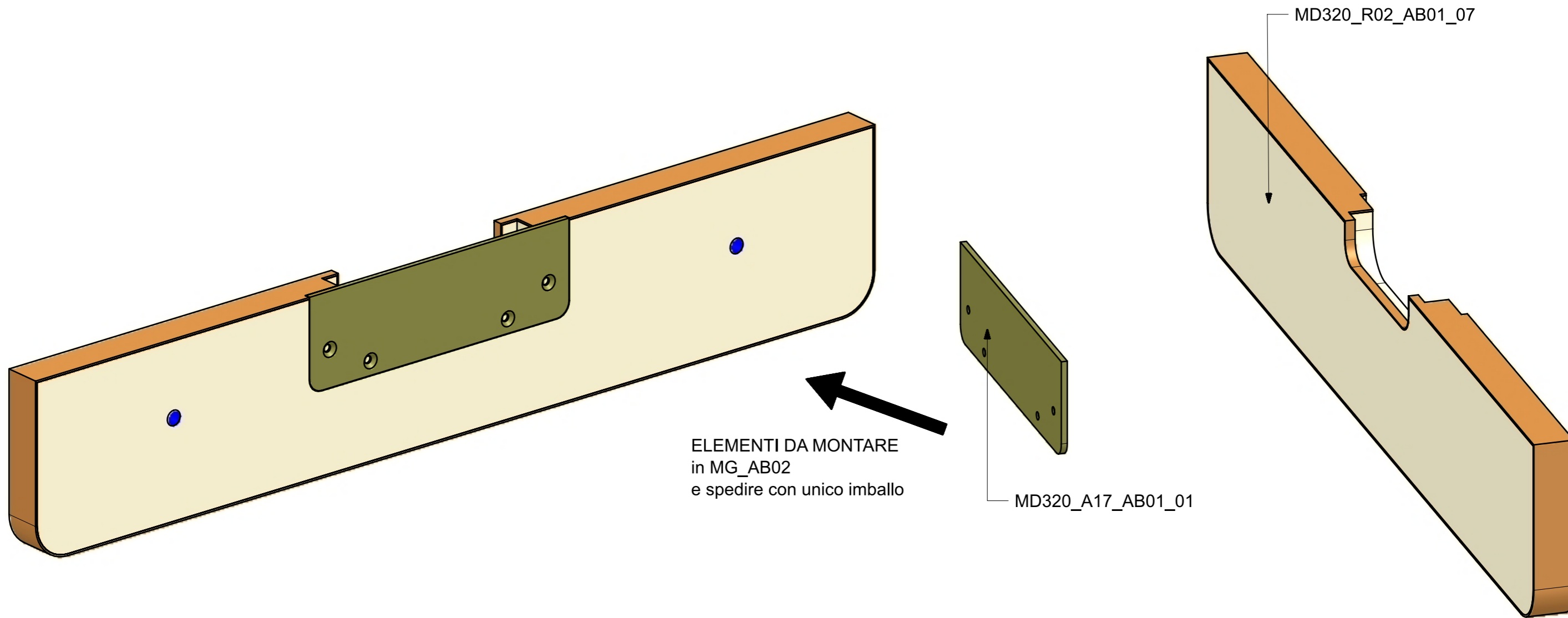

ELEMENTI DA MONTARE
in MG_AB02
e spedire con unico imballo

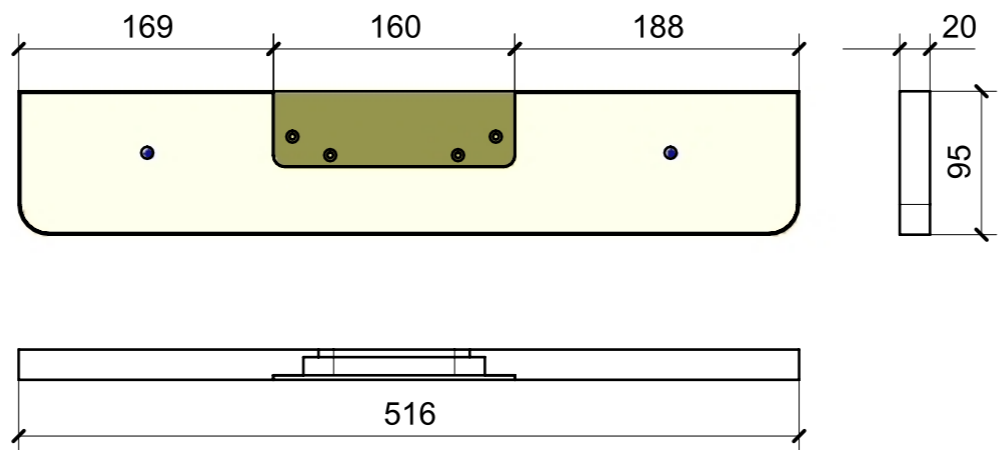

VERNICIATURA LASTRA/LACCATI:

NESSUN SIMBOLO = VERNICIARE 2 LATI + FILI RASATI O BORDATI
● = VERNICIARE 1 LATO + FILI RASATI O BORDATI

LOCALE	CODICE	DESCRIZIONE COMPONENTE	FINITURA	GR.
CABINA ARMATORE	MD320_MF_AF01	MOBILE SOSPESO ZONA TV		2

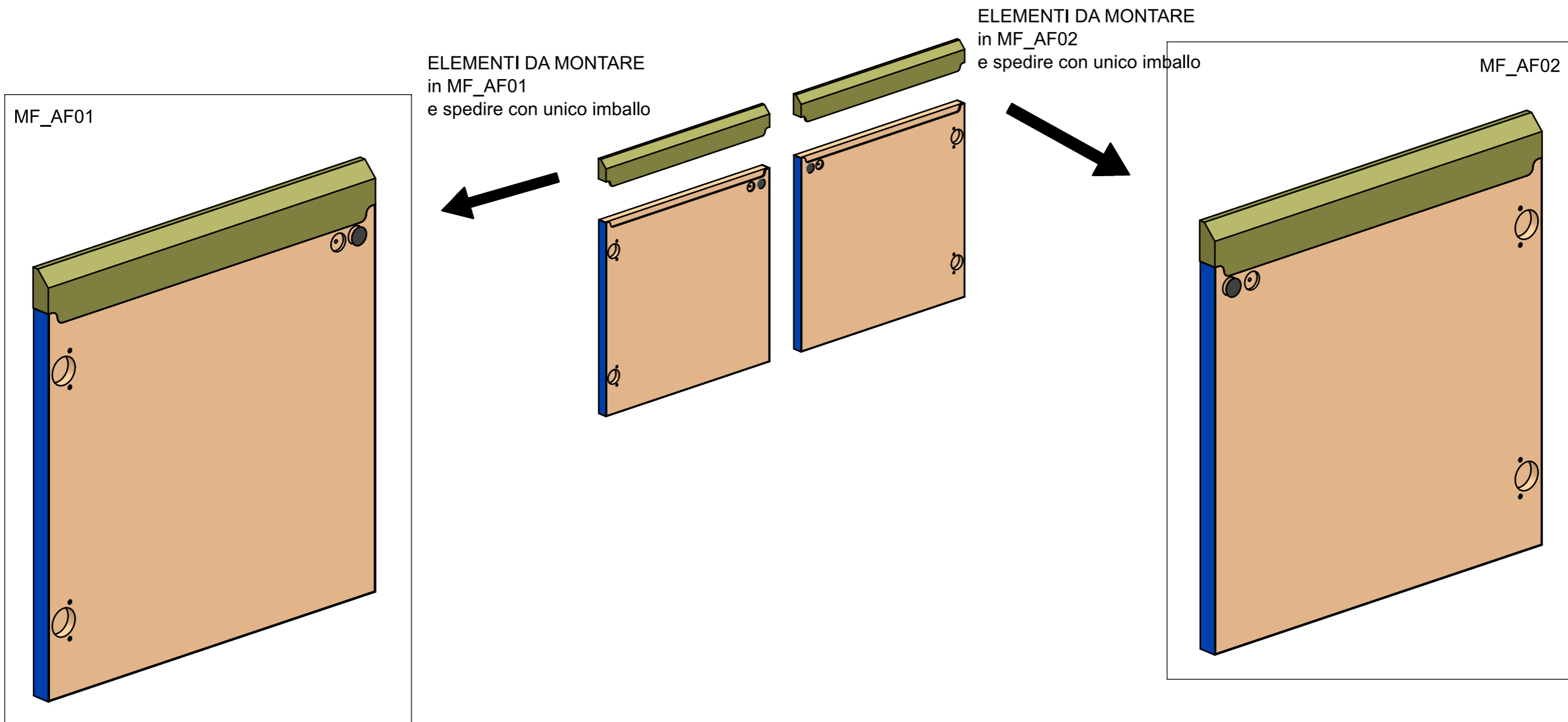

FERRAMENTA	QTY
BUSSOLA 5MA ANKOR BORGHI X CERNIERA COLLO PIENO	8
MAGNETE FORZA MAGNETICA1-5 10KG_HAFELE_246.87.112	2

VERNICIATURA LASTRA/LACCATI:

● = FILI RASATI ● = VERNICIARE 1 LATO + FILI RASATI O BORDATI NESSUN SIMBOLO = VERNICIARE 2 LATI + FILI RASATI O BORDATI

LOCALE	CODICE	DESCRIZIONE COMPONENTE	FINITURA	GR.
CABINA ARMATORE	MD320_MF_AH01	COMODINO SX		2

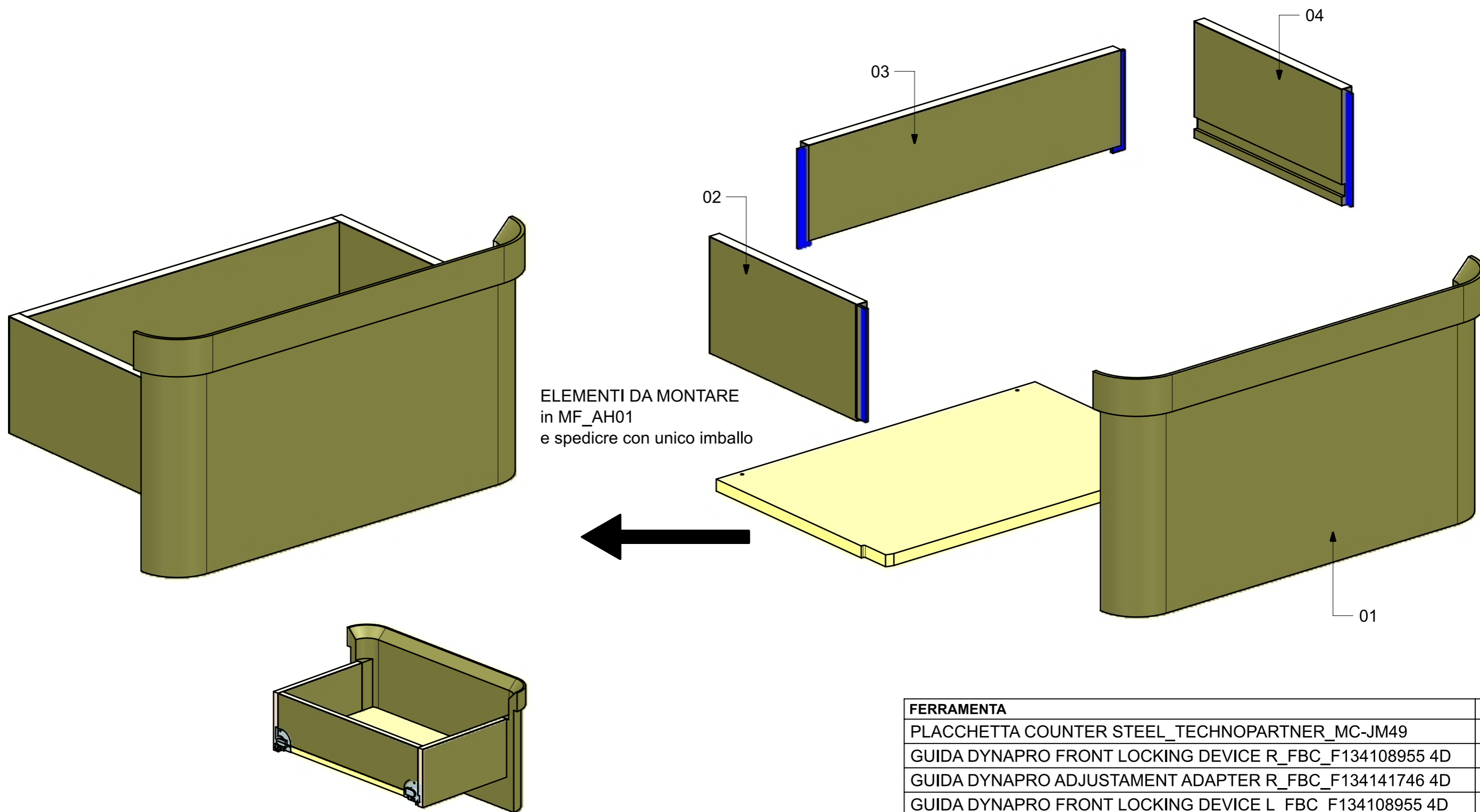

FERRAMENTA	QTY
PLACCHETTA COUNTER STEEL_TECHNOPARTNER_MC-JM49	1
GUIDA DYNAPRO FRONT LOCKING DEVICE R_FBC_F134108955 4D	1
GUIDA DYNAPRO ADJUSTAMENT ADAPTER R_FBC_F134141746 4D	1
GUIDA DYNAPRO FRONT LOCKING DEVICE L_FBC_F134108955 4D	1
GUIDA DYNAPRO ADJUSTAMENT ADAPTER L_FBC_F134141746 4D	1

LOCALE	CODICE	DESCRIZIONE COMPONENTE	FINITURA	GR.
CABINA ARMATORE	MD320_MF_AI01	COMODINO DX		2

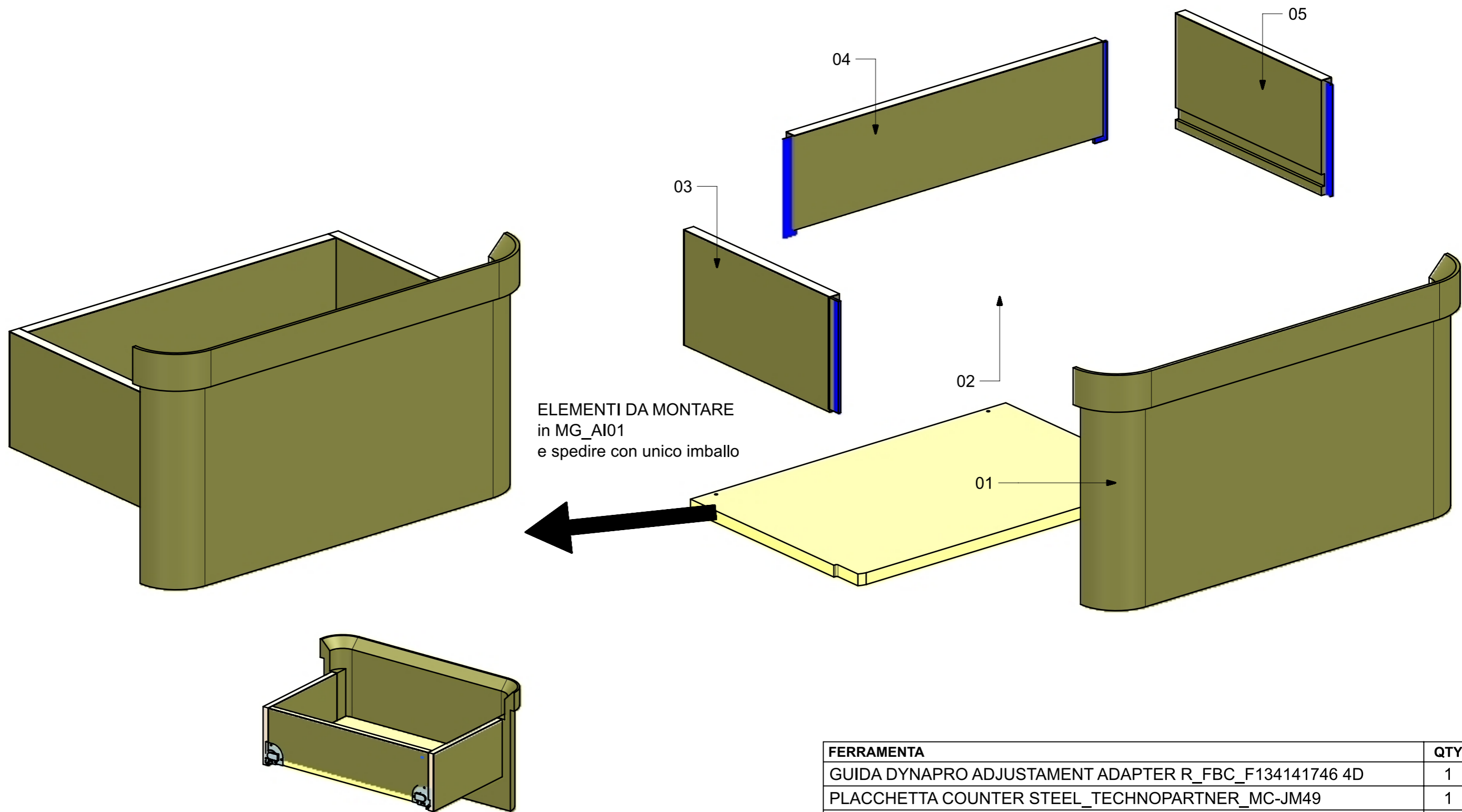

FERRAMENTA	QTY
GUIDA DYNAPRO ADJUSTMENT ADAPTER R_FBC_F134141746 4D	1
PLACCHETTA COUNTER STEEL_TECHNOPARTNER_MC-JM49	1
GUIDA DYNAPRO FRONT LOCKING DEVICE R_FBC_F134108955 4D	1
GUIDA DYNAPRO ADJUSTMENT ADAPTER L_FBC_F134141746 4D	1
GUIDA DYNAPRO FRONT LOCKING DEVICE L_FBC_F134108955 4D	1

LOCALE	CODICE	DESCRIZIONE COMPONENTE	FINITURA	GR.
CABINA ARMATORE	MD321_MF_AZ01	TAVOLO VANITY OPT		PTP

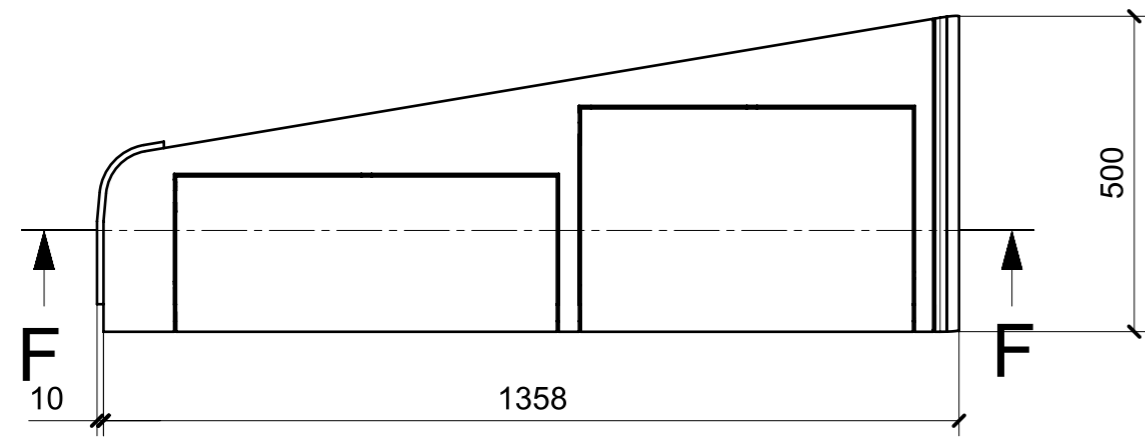
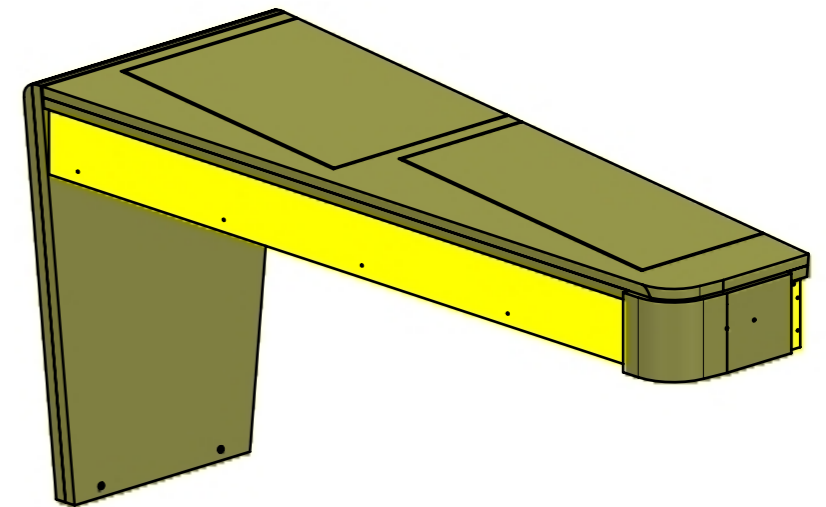
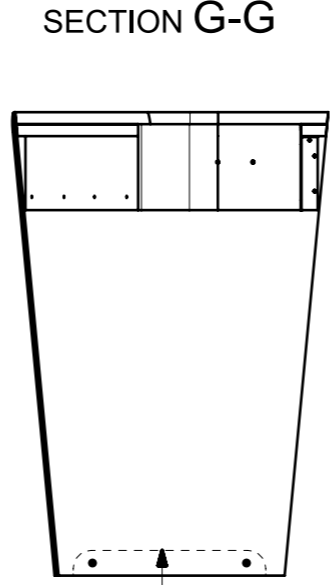
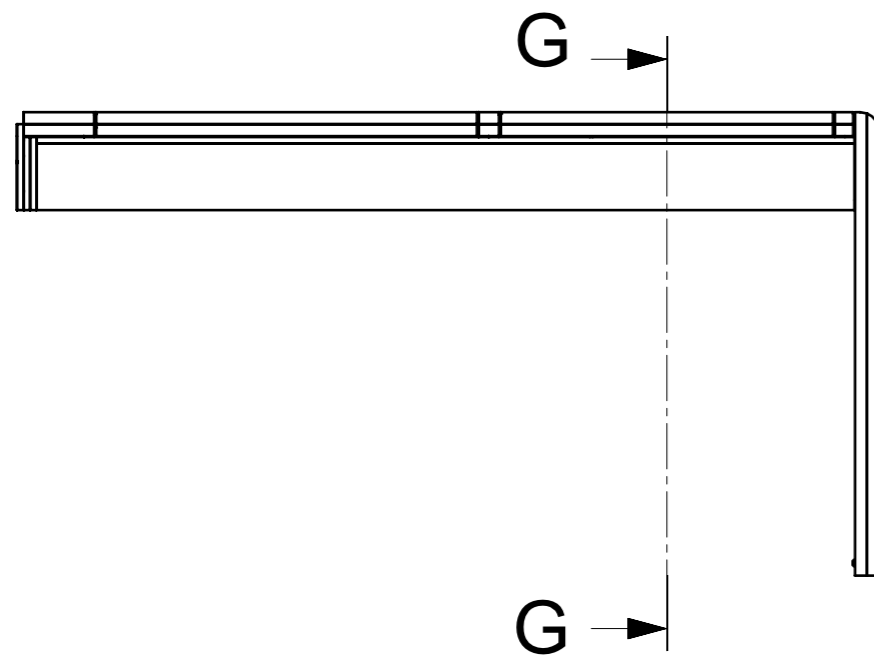
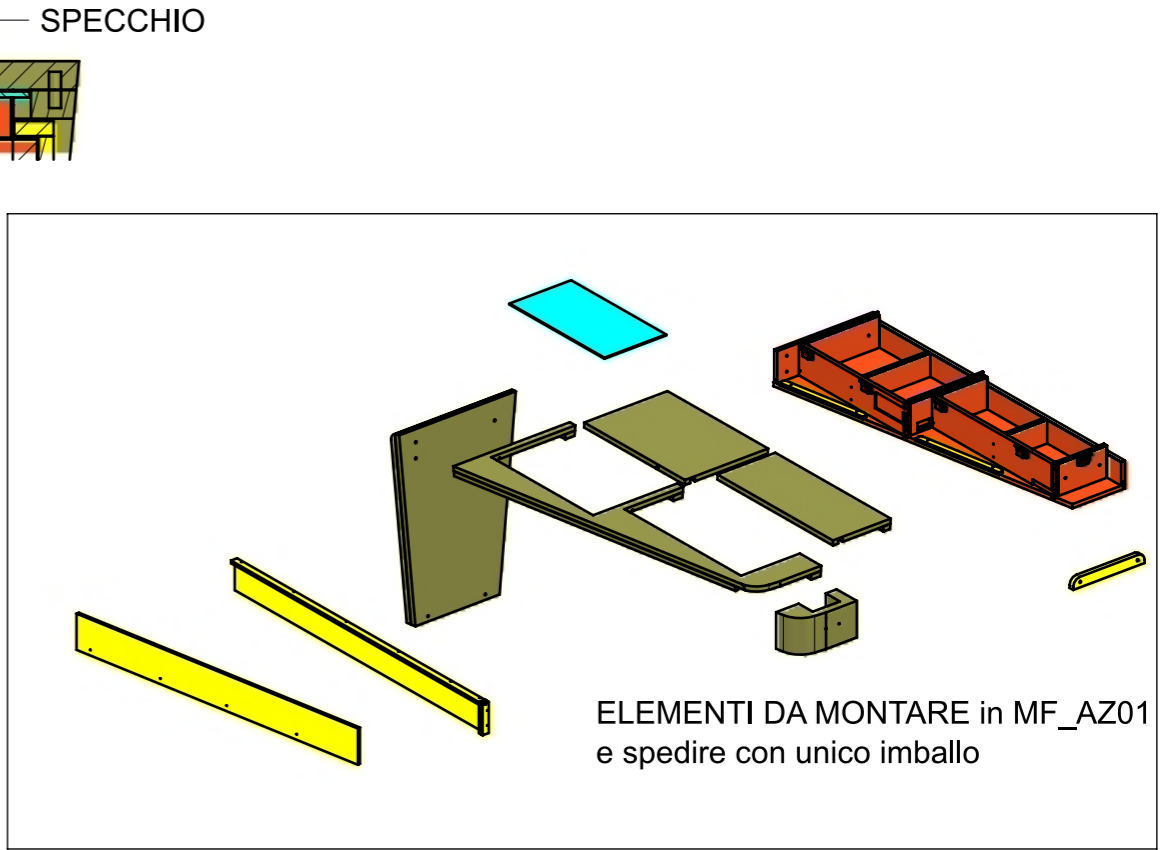
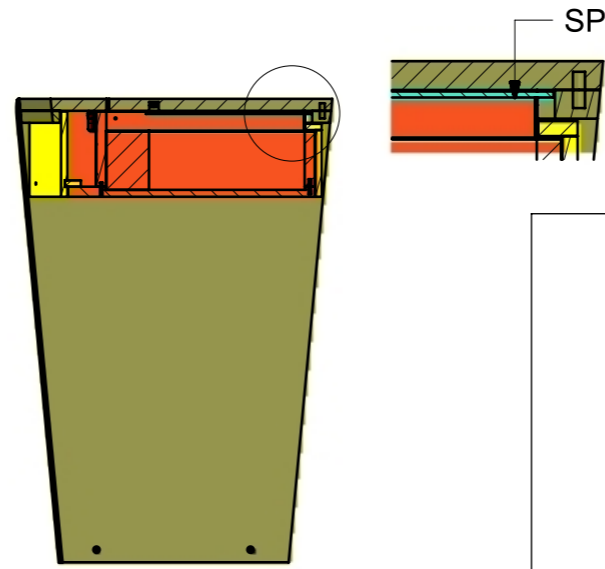
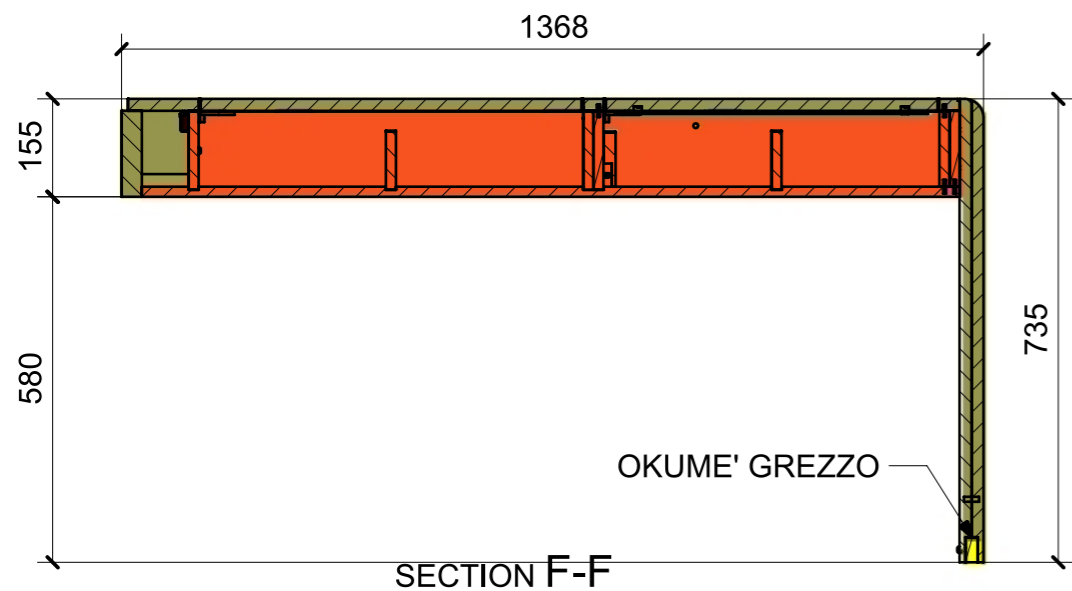

FERRAMENTA	QTY
BUSSOLA 6MA X 10 FORO DIAM.8	9
CAVO_LOOX5_COB_24V_2.0M_HAFELE_833_75_764_STP	2
CAVO_MODURARE_DISP.ACCENSIONE_2.0M_HAFELE_833_89_142_STP	1
CERNIERA PER COPERCHIO_HAFELE_356.53.310	2
CHIUSURA A SPINTA_TECHNOPARTNER_SOU C3-203	6
DRIVER DISTRIBUTORE A 6 VIE_HAFELE_833_77_833	1
LED 3104 24V_906W_M 3000K_CRI90_50M_HAFELE_833_76_516_H200	2
LOOX5_CAVO_PROLUNGA_24V_2.0M_HAFELE_833_95_717	1
MAGNETE_TONDO_AL_NEODIMIO M_F_FOR_377_15X3_BORGHI_00533157	8
SENSORE RETROANTA_HAFELE_833_89_334	1
VITE 6MA X 25 TESTA BOMBATA NERA BHCS 10.9 ISO 7380	6
VITE 6MA X 40 TESTA BOMBATA NERA BHCS	1

LOCALE	CODICE	DESCRIZIONE COMPONENTE	FINITURA	GR.
CABINA ARMATORE	MD321_MF_AAT01	FACCIATA ARMADIO PRUA VAR.1		2

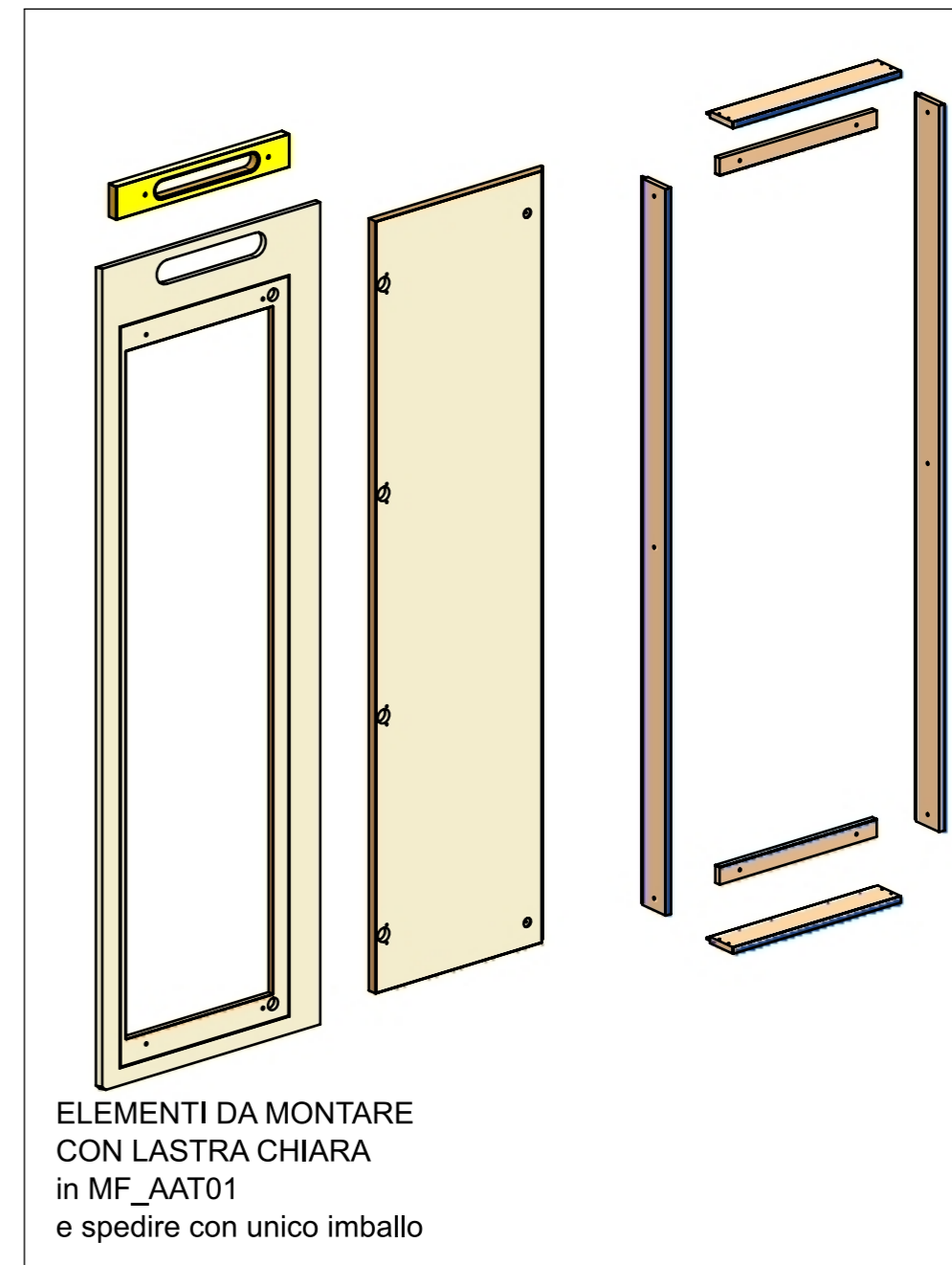
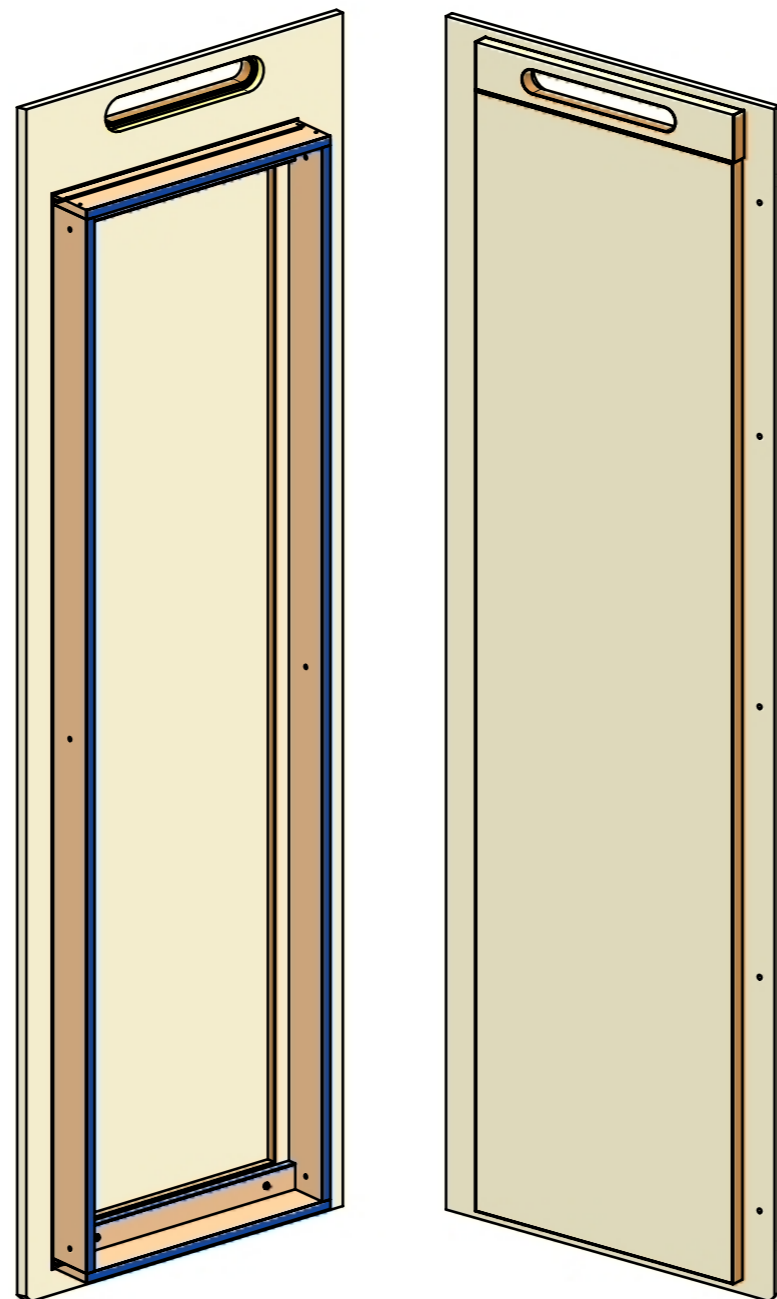
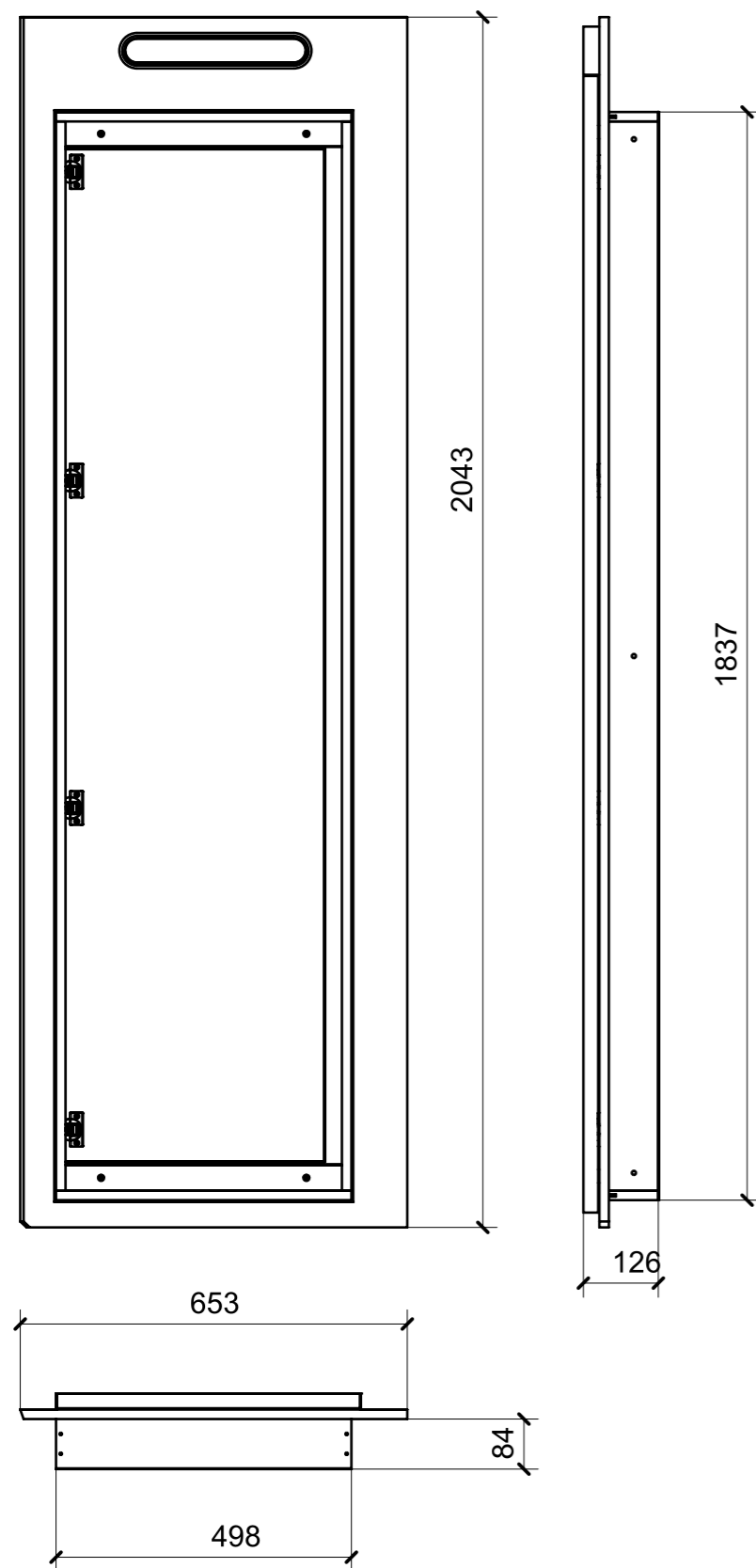

FERRAMENTA	QTY
BASE_3-NERA_HAFELE_342.22.067-BLUM_175H3130.STP	4
BUSSOLA 5MA ANKOR BORGHI	8
BUSSOLA 5MA ANKOR BORGHI X CERNIERA COLLO PIENO	8
BUSSOLA 6MA X 10 FORO DIAM.8	4
CERNIERA 94°_PIANA-NERA_HAFELE_342.46.604-BLUM_71B9550.STP	4
MAGNETE FORZA MAGNETICA1-5 10KG_HAFELE_246.87.112	2
RISCONTRO IN FERRO PER CALAMITA DA FAR PRODURRE	2
VITE 4MAX8 ANKOR BORGHI	8
VITE 4MAX8 ANKOR BORGHI X CERNIERA COLLO PIENO	8
VITE 6MA X 25 TESTA BOMBATA NERA BHCS 10.9 ISO 7380	4

LOCALE	CODICE	DESCRIZIONE COMPONENTE	FINITURA	GR.
CABINA ARMATORE	MD320_MF_AU01	FACCIATA ARMADIO PRUA VAR1-VAR2		2

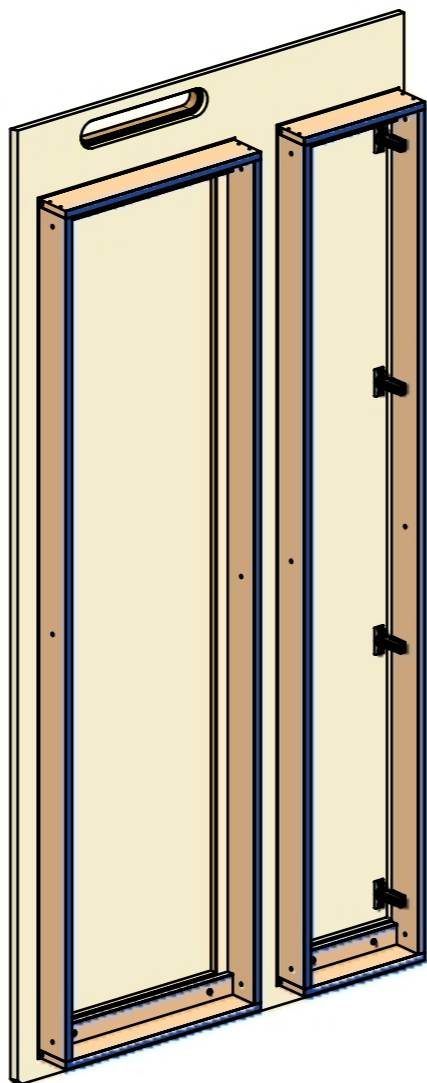
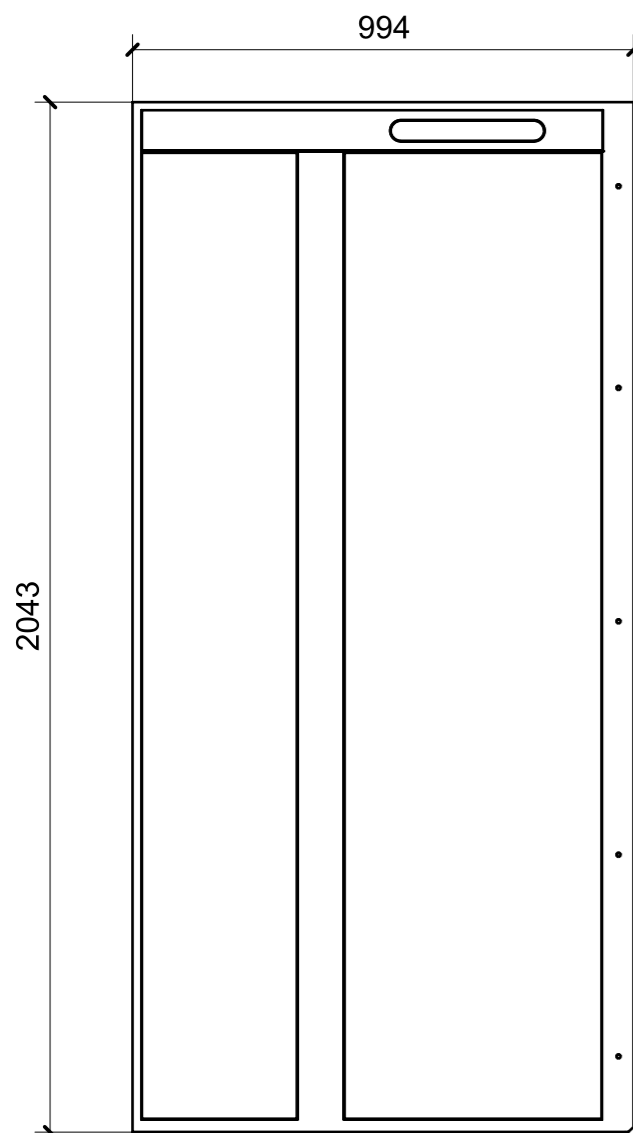

ELEMENTI DA MONTARE
in MF_AU01
e spedire con unico imballo

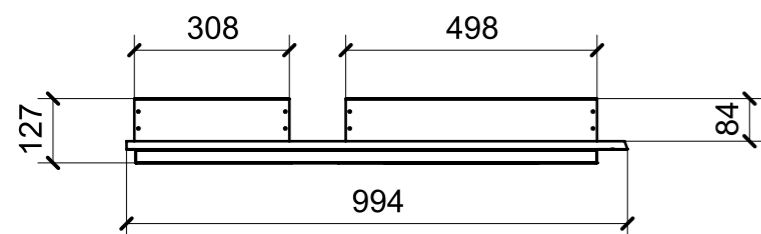
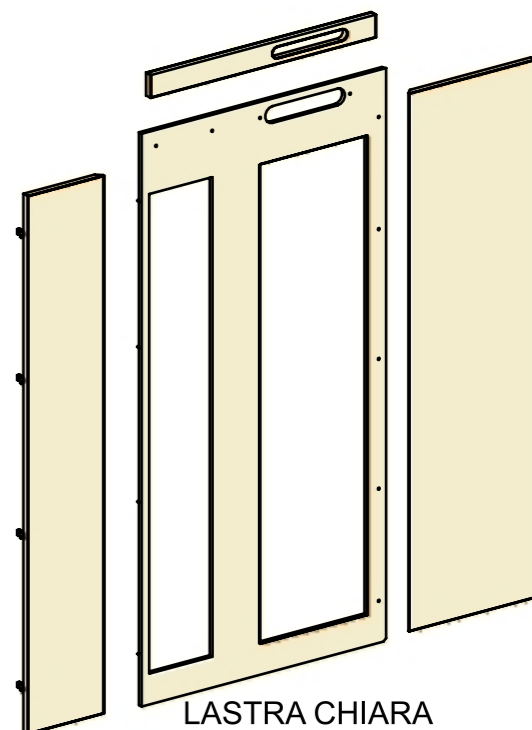
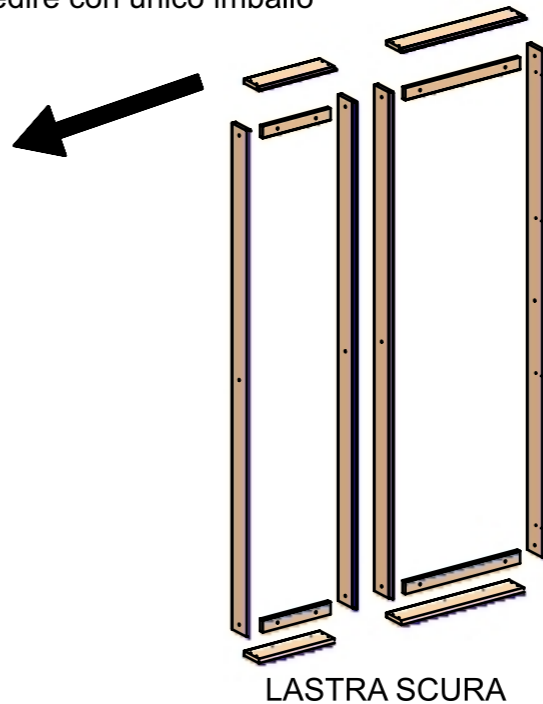

FERRAMENTA	QTY
BASE_3-NERA_HAFELE_342.22.067-BLUM_175H3130.STP	8
BUSSOLA 5MA ANKOR BORGHI	16
BUSSOLA 5MA ANKOR BORGHI X CERNIERA COLLO PIENO	16
BUSSOLA 6MA X 10 FORO DIAM.8	8
CERNIERA 94°_PIANA-NERA_HAFELE_342.46.604-BLUM_71B9550.STP	8
MAGNETE FORZA MAGNETICA1-5 10KG_HAFELE_246.87.112	4
RISCONTRO IN FERRO PER CALAMITA DA FAR PRODURRE	4
VITE 4MAX8 ANKOR BORGHI	16
VITE 4MAX8 ANKOR BORGHI X CERNIERA COLLO PIENO	16
VITE 6MA X 25 TESTA BOMBATA NERA BHCS 10.9 ISO 7380	8

VERNICIATURA LASTRA/LACCATI:

● = VERNICIARE 1 LATO + FILI RASATI O BORDATI

NESSUN SIMBOLO = VERNICIARE 2 LATI + FILI RASATI O BORDATI

LOCALE	CODICE	DESCRIZIONE COMPONENTE	FINITURA	GR.
CABINA ARMATORE	MD320_MF_AAU01	FACCIATA ARMADIO PRUA VAR3-VAR4		2

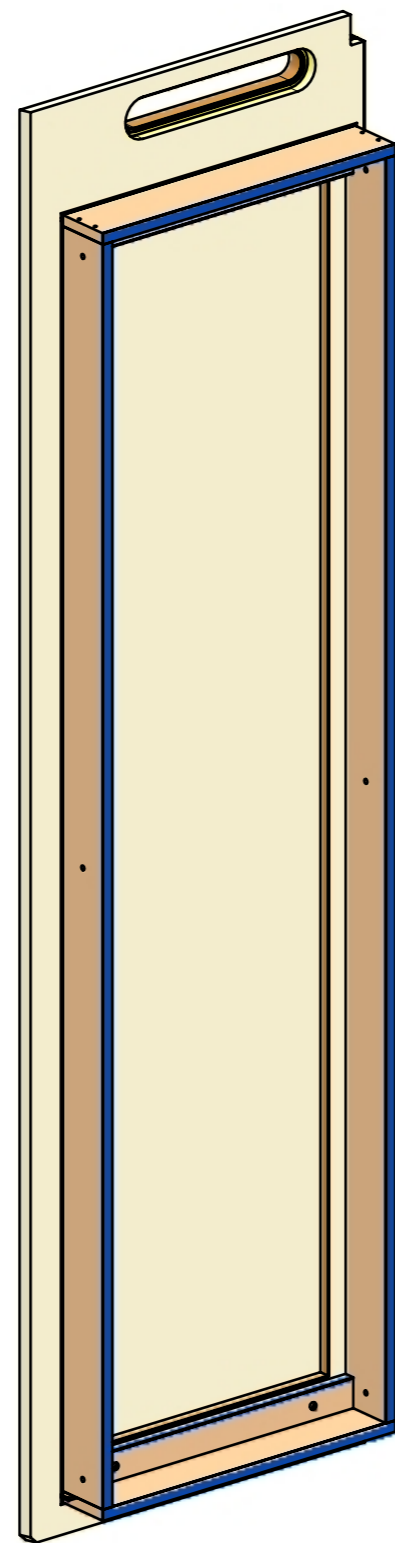
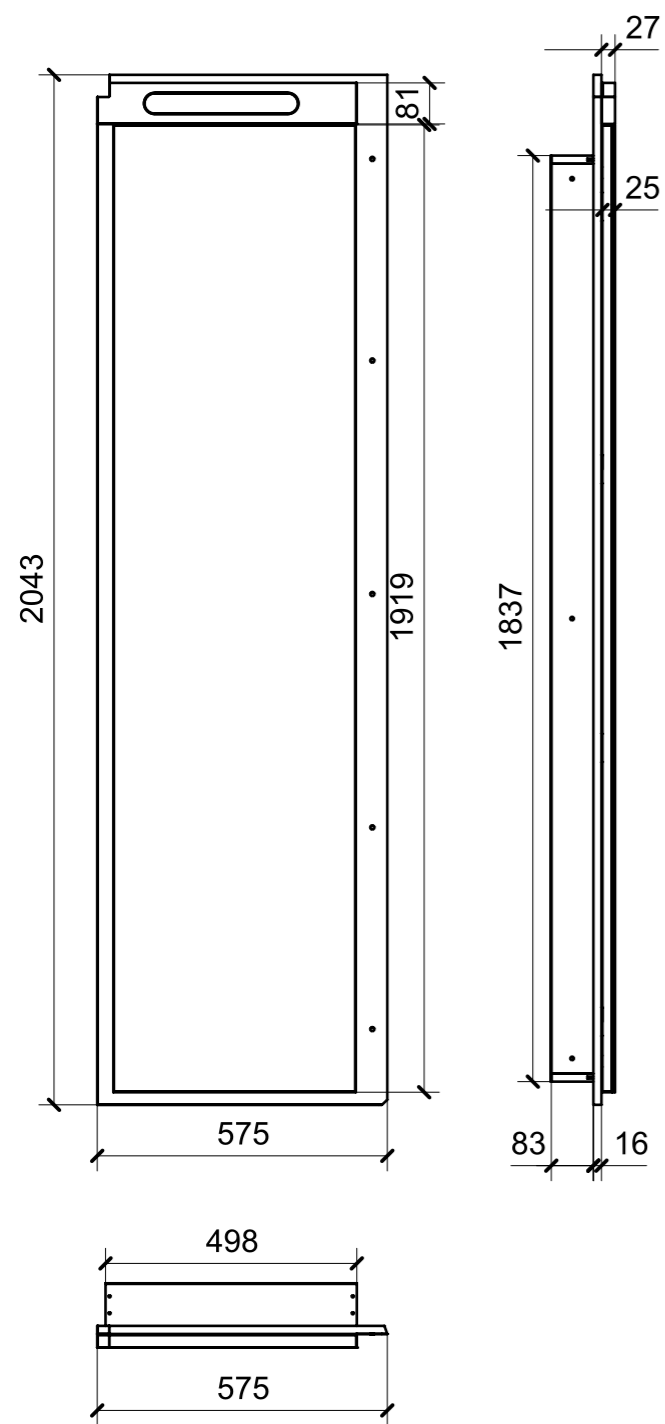

ELEMENTI DA MONTARE
in MF_AAU01
e spedire con unico imballo

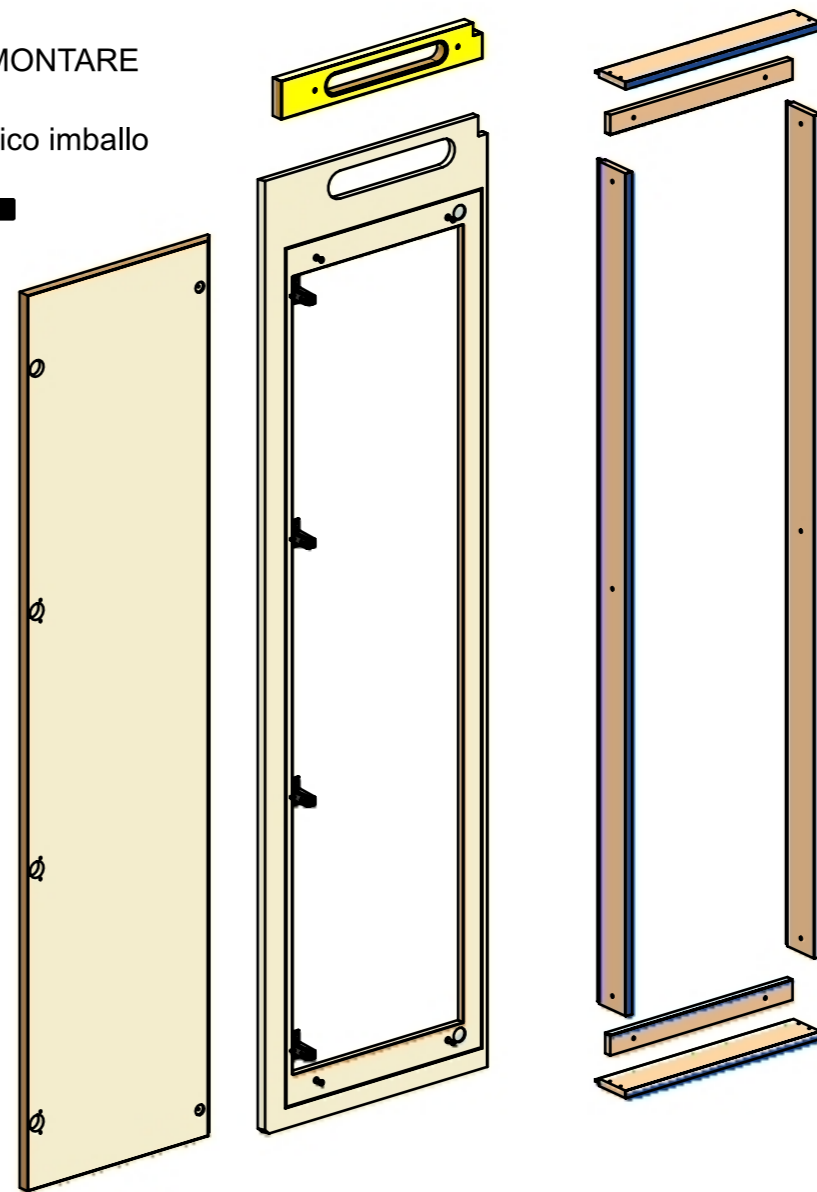

FERRAMENTA	QTY
RISCONTRO IN FERRO PER CALAMITA DA FAR PRODURRE	2
VITE 6MA X 25 TESTA BOMBATA NERA BHCS 10.9 ISO 7380	4
CERNIERA 94°_PIANA-NERA_HAFELE_342.46.604-BLUM_71B9550.STP	4
VITE 4MAX8 ANKOR BORGHI X CERNIERA COLLO PIENO	8
BASE_3-NERA_HAFELE_342.22.067-BLUM_175H3130.STP	4
MAGNETE FORZA MAGNETICA1-5 10KG_HAFELE_246.87.112	2
BUSSOLA 5MA ANKOR BORGHI	8
BUSSOLA 5MA ANKOR BORGHI X CERNIERA COLLO PIENO	8
BUSSOLA 6MA X 10 FORO DIAM.8	4
VITE 4MAX8 ANKOR BORGHI	8