

LOCALE	CODICE	DESCRIZIONE COMPONENTE	FINITURA	GR.
CUCINA	MD320_R02_KA01	CASSA FRIGO POPPA	LASTRA CHIARA	2

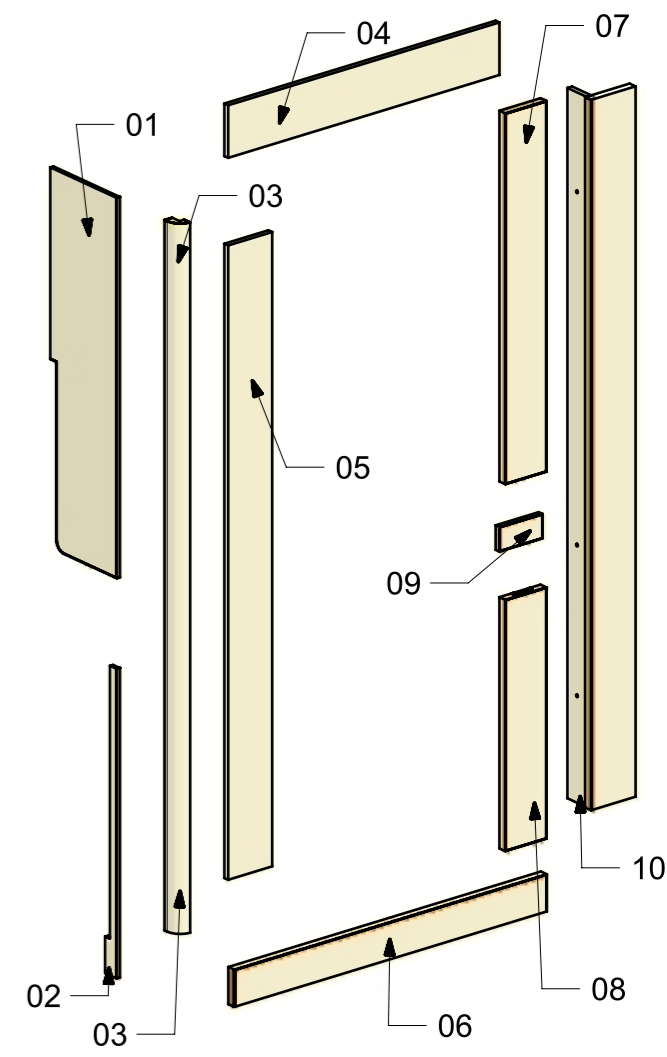
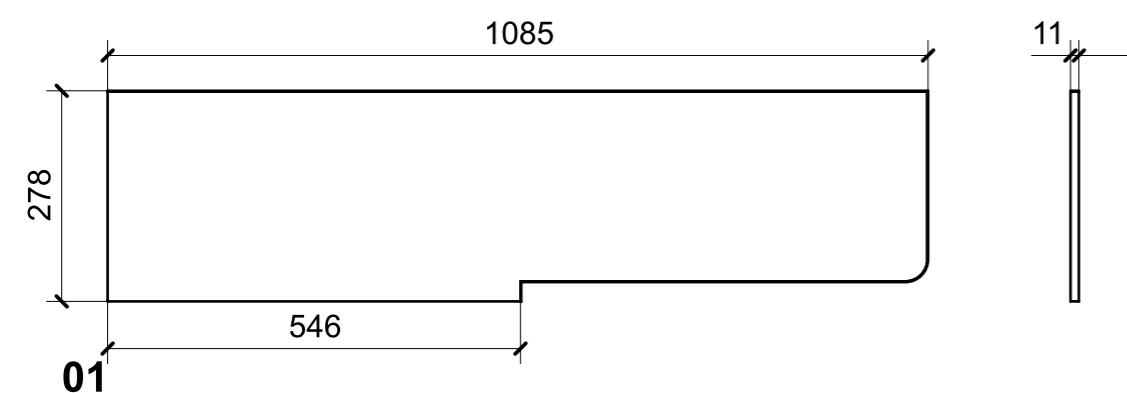
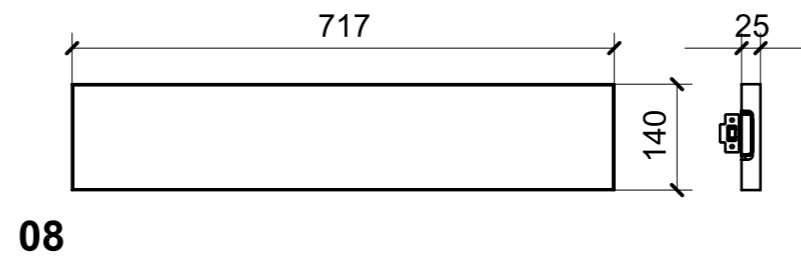
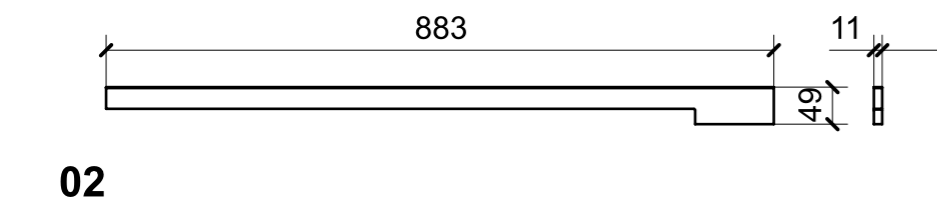
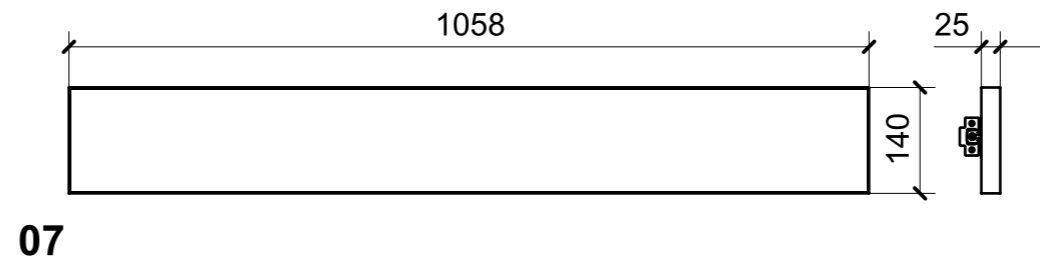
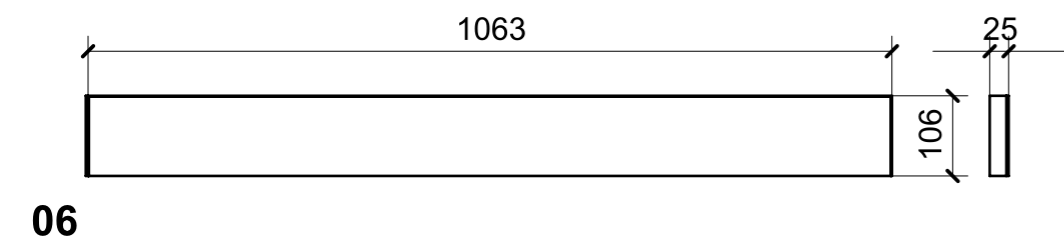
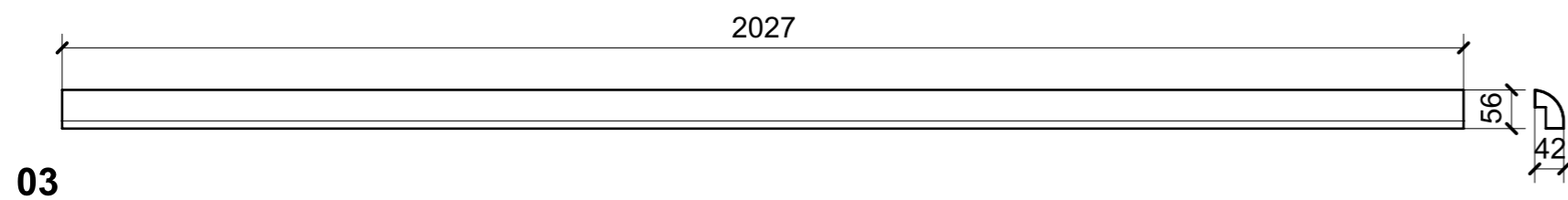
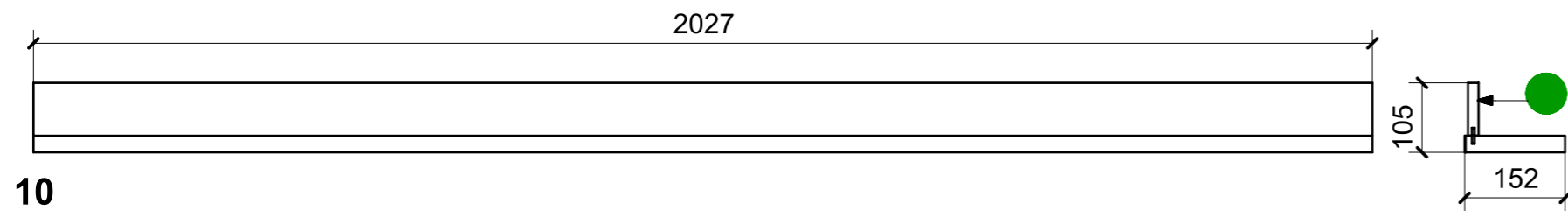
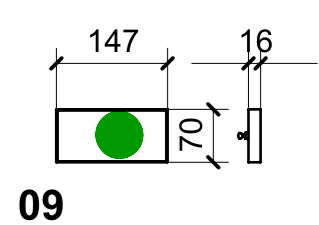
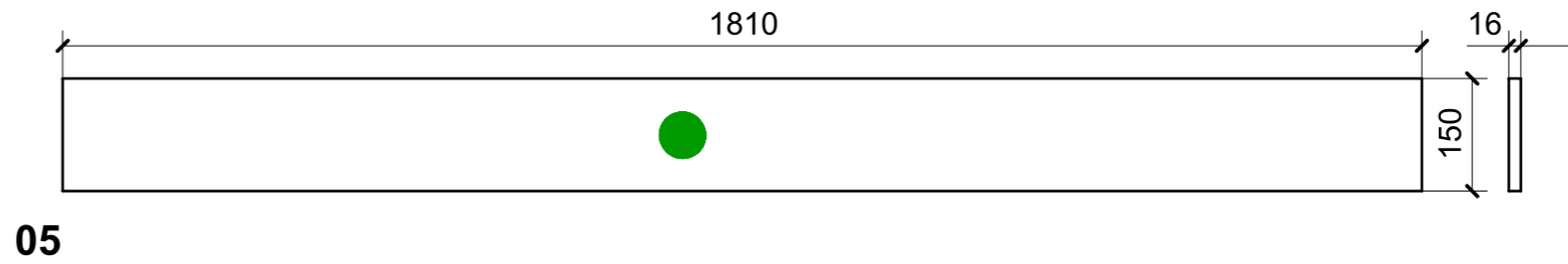
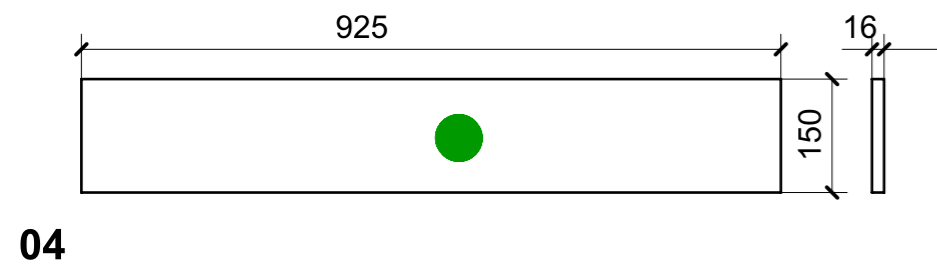

FERRAMENTA	QTY
MANIGLIA AD INCASSO_FORESTI_ART 238 C	2
MS INCASSO_ITALVIPLA_972_FMPC_M1B	2

VERNICIATURA LASTRA/LACCATI:

● = VERNICIARE 1 LATO + FILI RASATI O BORDATI

NESSUN SIMBOLO = VERNICIARE 2 LATI + FILI RASATI O BORDATI

LOCALE	CODICE	DESCRIZIONE COMPONENTE	FINITURA	GR.
CUCINA	MD320_R02_KB01	CASSA RICIRCOLO ARIA FRIGO POPPA	LASTRA CHIARA	2

01

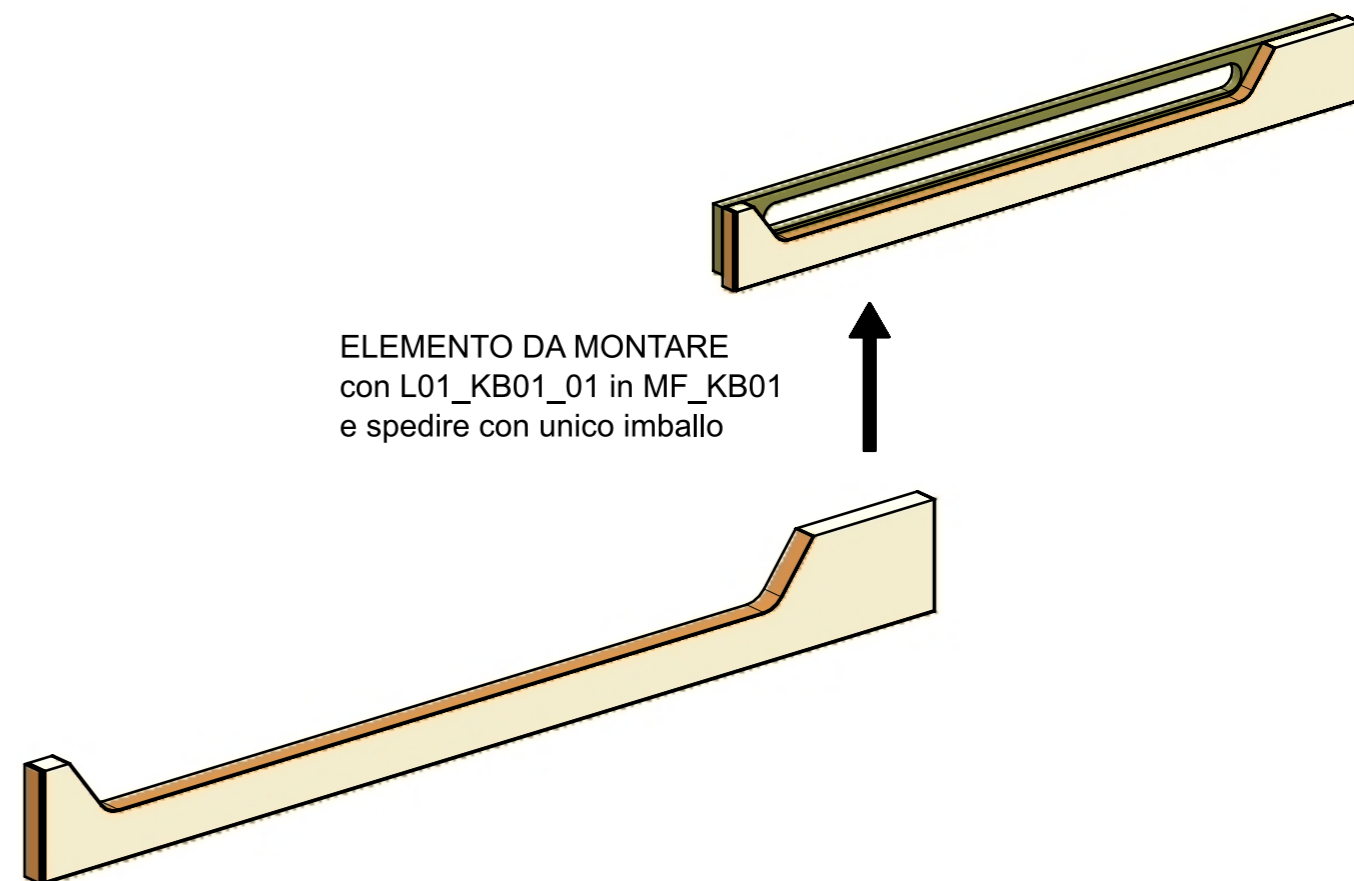
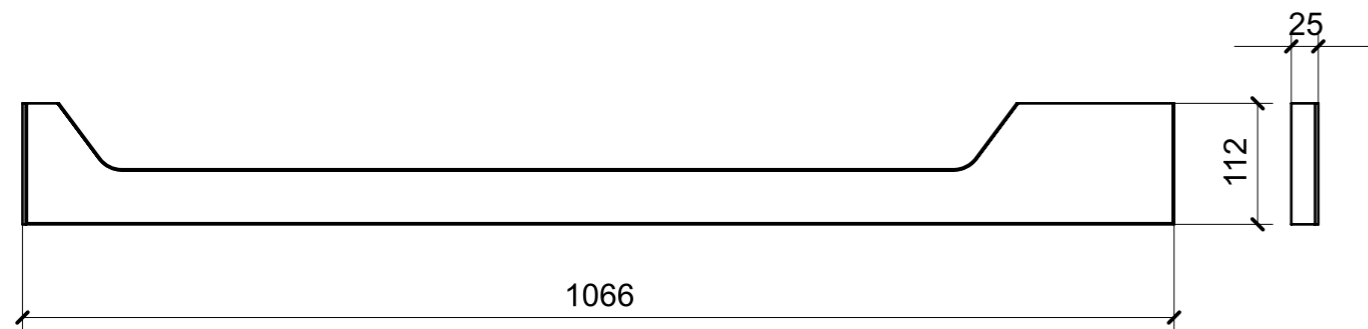

ELEMENTO DA MONTARE  
con L01\_KB01\_01 in MF\_KB01  
e spedire con unico imballo

VERNICIATURA LASTRA/LACCATI:

● = VERNICIARE 1 LATO + FILI RASATI O BORDATI

NESSUN SIMBOLO = VERNICIARE 2 LATI + FILI RASATI O BORDATI

LOCALE	CODICE	DESCRIZIONE COMPONENTE	FINITURA	GR.
CUCINA	MD320_R02_KC01	BASE CUCINA POPPA	LASTRA CHIARA	2

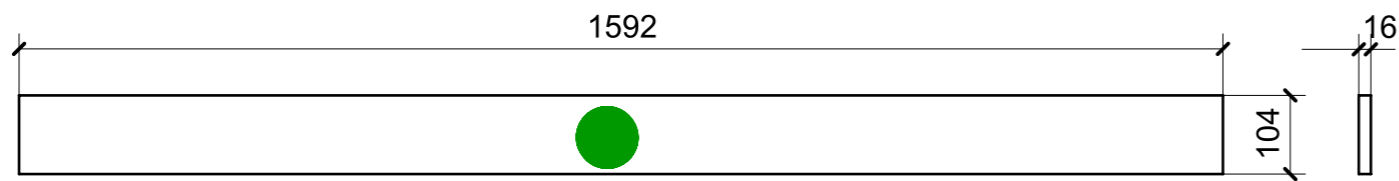

01

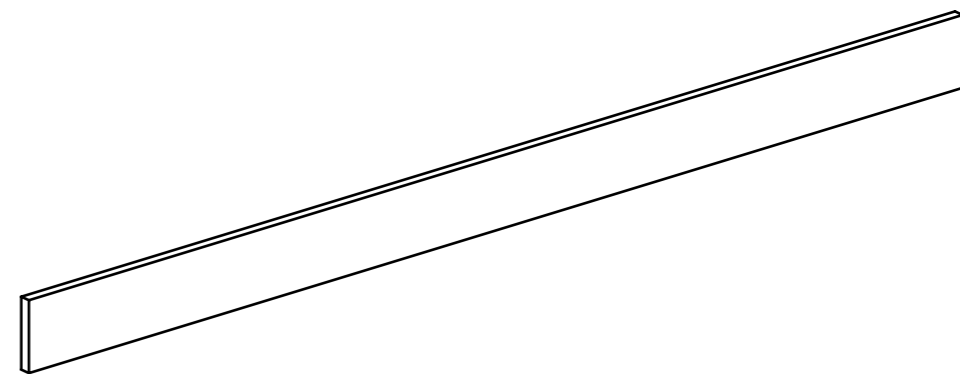

VERNICIATURA LASTRA/LACCATI:

● = VERNICIARE 1 LATO + FILI RASATI O BORDATI

NESSUN SIMBOLO = VERNICIARE 2 LATI + FILI RASATI O BORDATI

LOCALE	CODICE	DESCRIZIONE COMPONENTE	FINITURA	GR.
CUCINA	MD320_R02_KF01	BASE CUCINA PRUA	LASTRA CHIARA	2

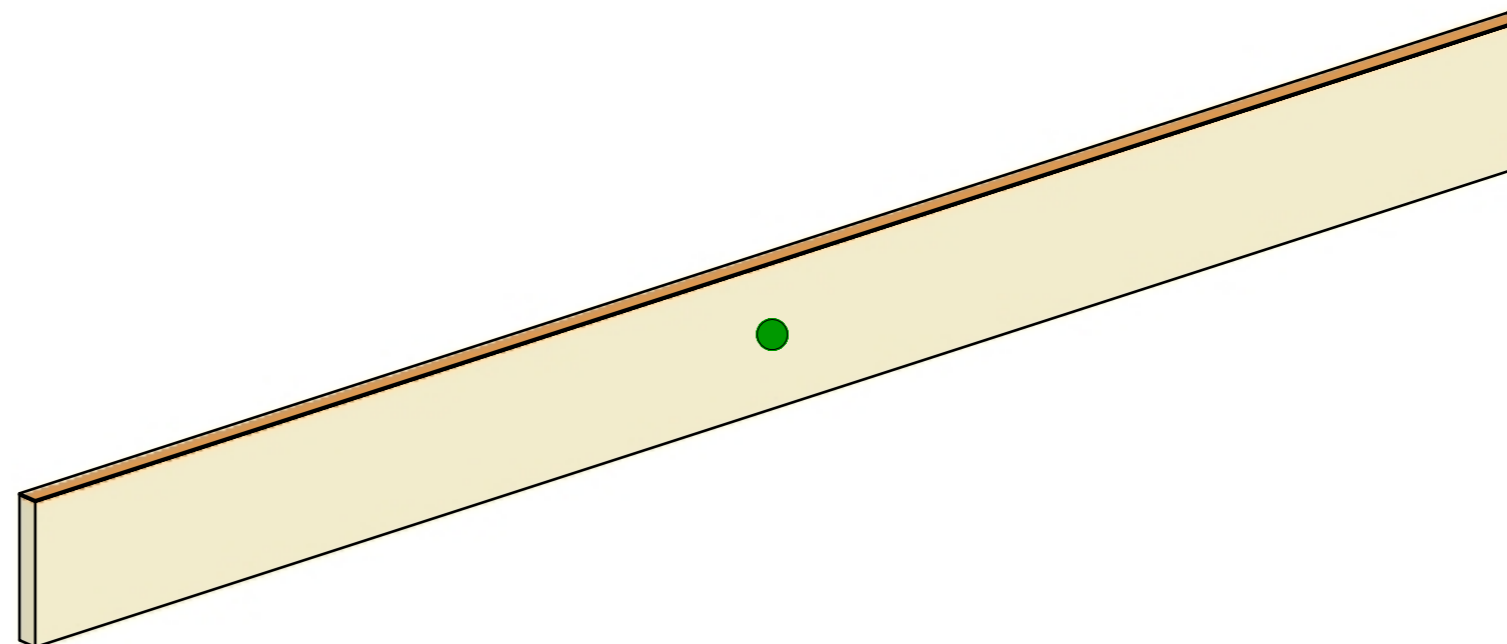
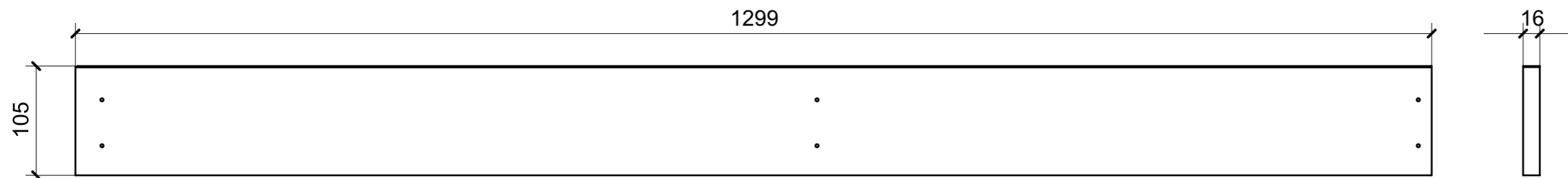

● = FILI RASATI

VERNICIATURA LASTRA/LACCATI:

● = VERNICIARE 1 LATO + FILI RASATI O BORDATI

NESSUN SIMBOLO = VERNICIARE 2 LATI + FILI RASATI O BORDATI

LOCALE	CODICE	DESCRIZIONE COMPONENTE	FINITURA	GR.
CUCINA	MD320_R02_KH01	RIV.LATO SX BASE E PENSILE DI PRUA	LASTRA CHIARA	2

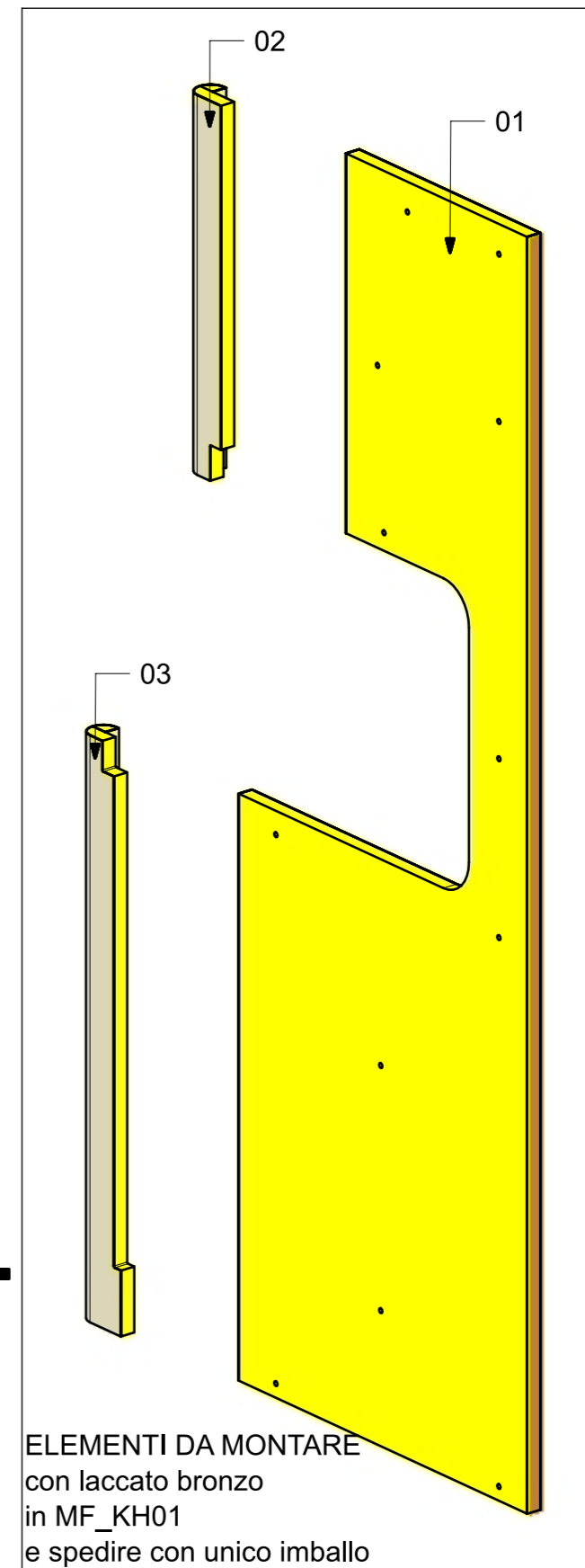
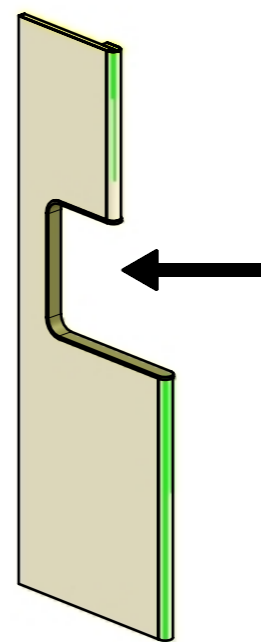
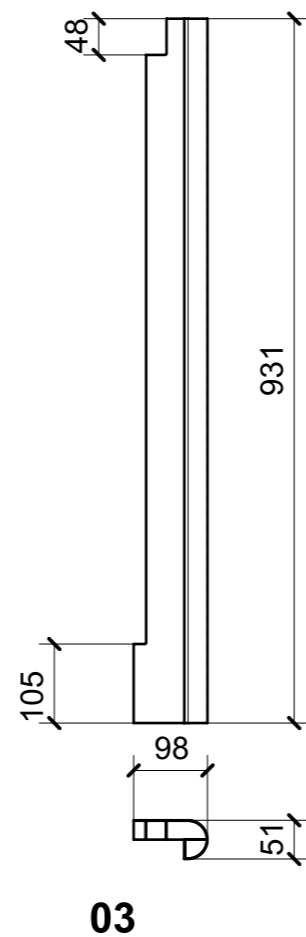
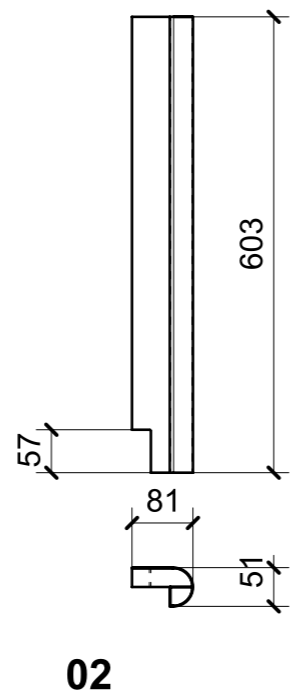
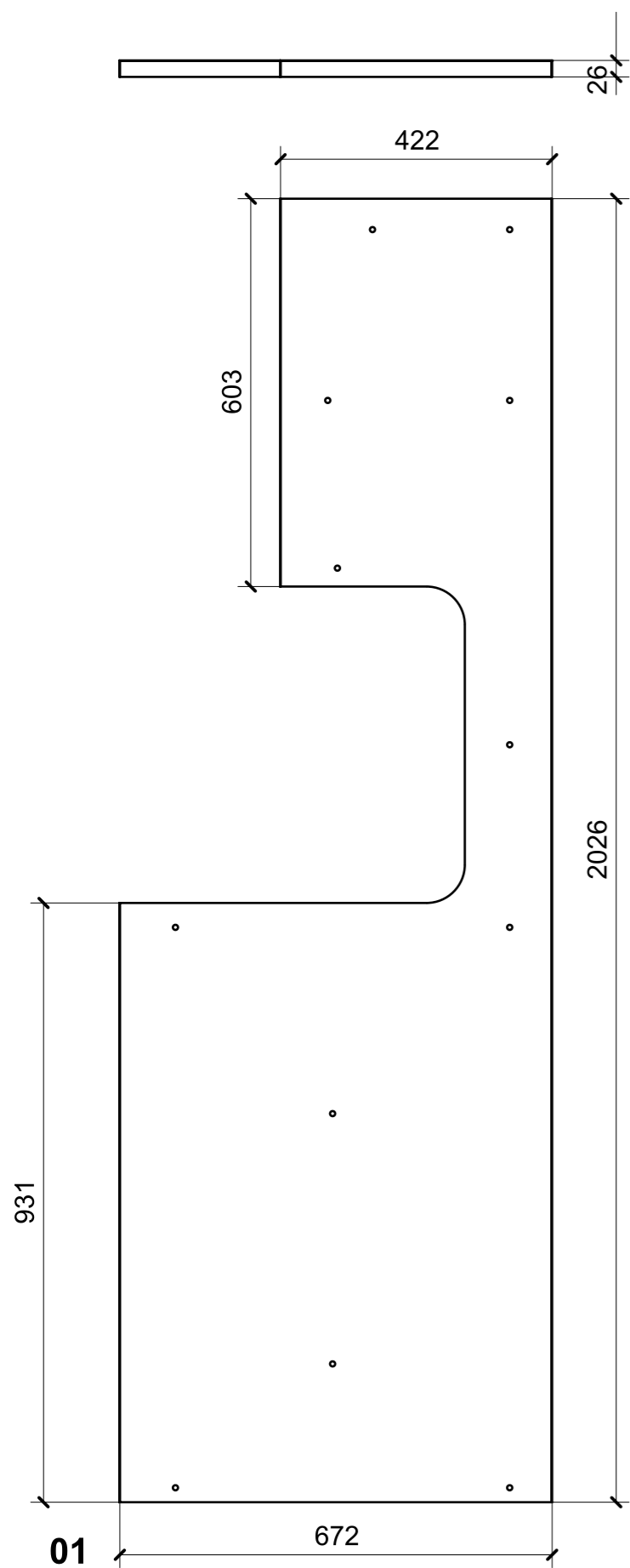

ELEMENTI DA MONTARE  
con laccato bronzo  
in MF\_KH01  
e spedire con unico imballo

LOCALE	CODICE	DESCRIZIONE COMPONENTE	FINITURA	GR.
CUCINA	MD320_R01_KL01	MOBILE PORTABICCHIERI	LASTRA SCURA	2

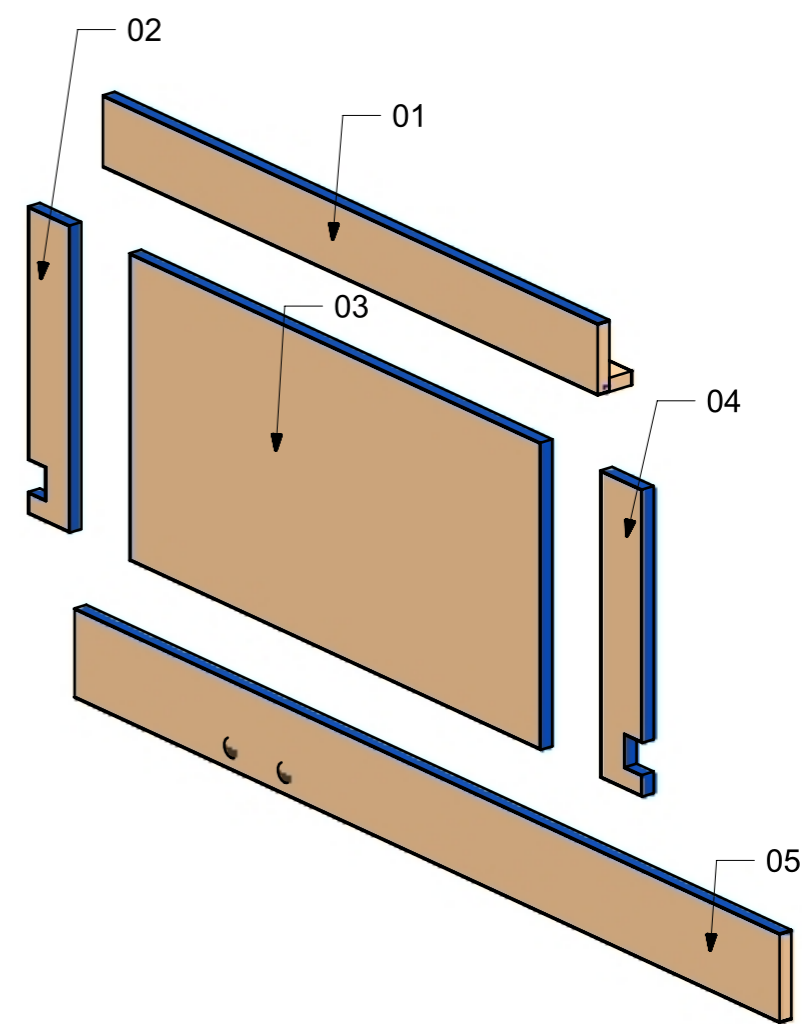
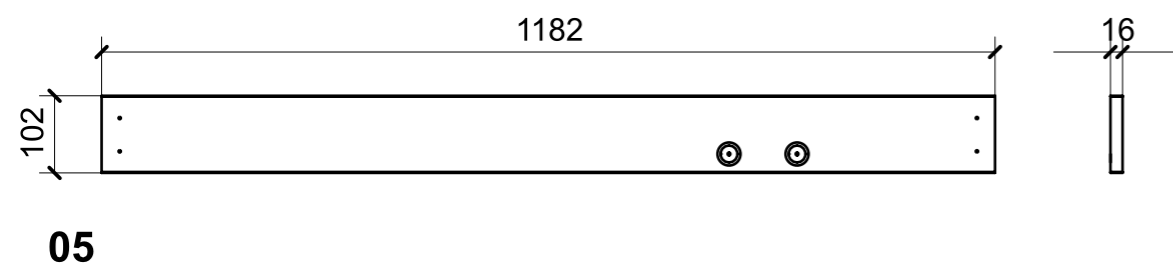
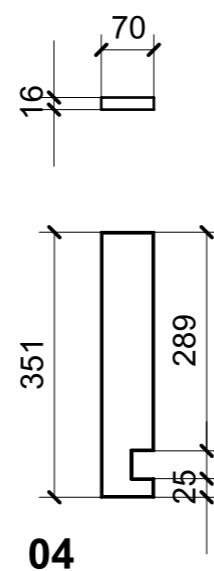
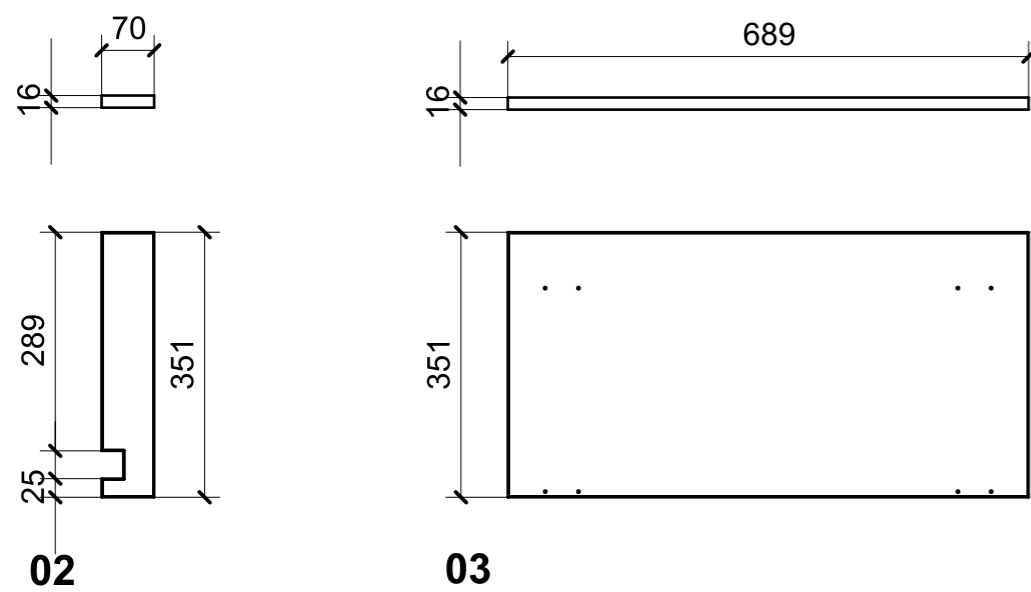
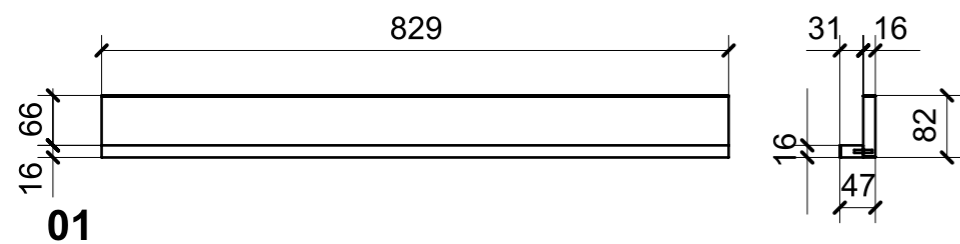

FERRAMENTA	QTY
MAGNETE FORZA MAGNETICA1-5 10KG_HAFELE_246.87.112	2

VERNICIATURA LASTRA/LACCATI:

● = FILI RASATI

● = VERNICIARE 1 LATO + FILI RASATI O BORDATI

NESSUN SIMBOLO = VERNICIARE 2 LATI + FILI RASATI O BORDATI

LOCALE	CODICE	DESCRIZIONE COMPONENTE	FINITURA	GR.
CUCINA	MD320_R02_KL01	MOBILE PORTABICCHIERI	LASTRA CHIARA	2

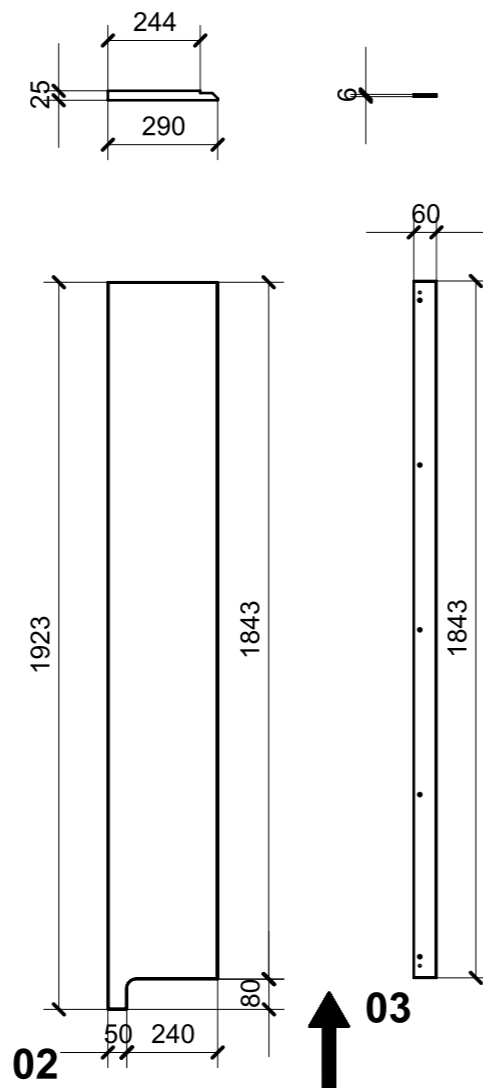
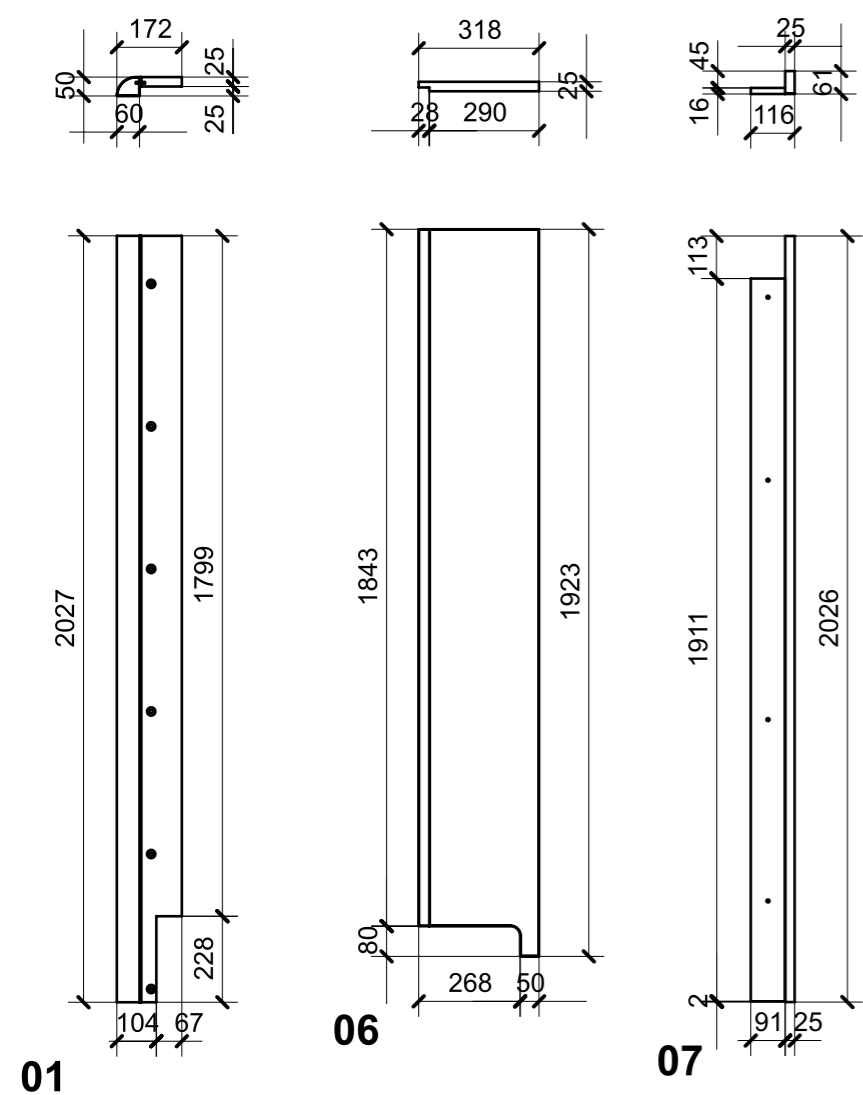

ELEMENTI DA MONTARE in MG\_KL02 e spedire con unico imballo

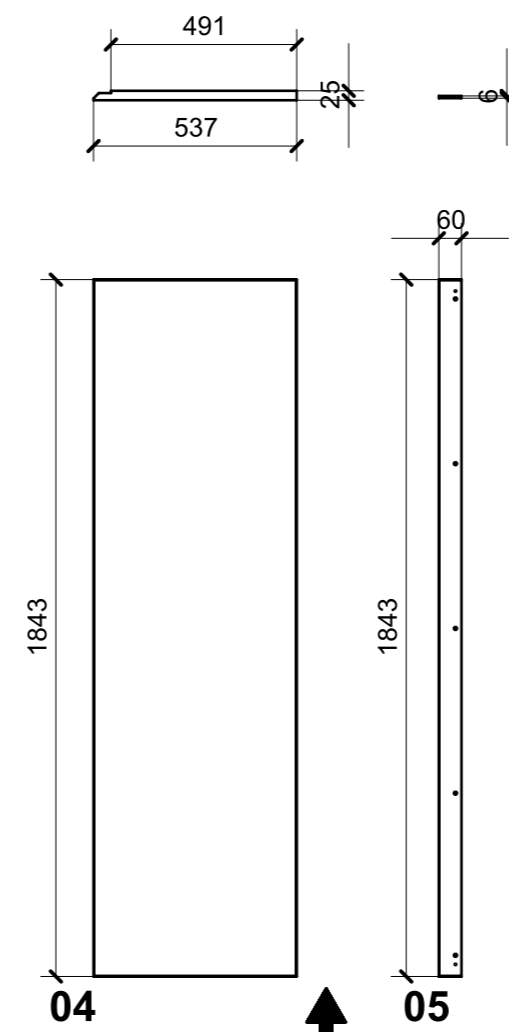

ELEMENTI DA MONTARE in MG\_KL03 e spedire con unico imballo

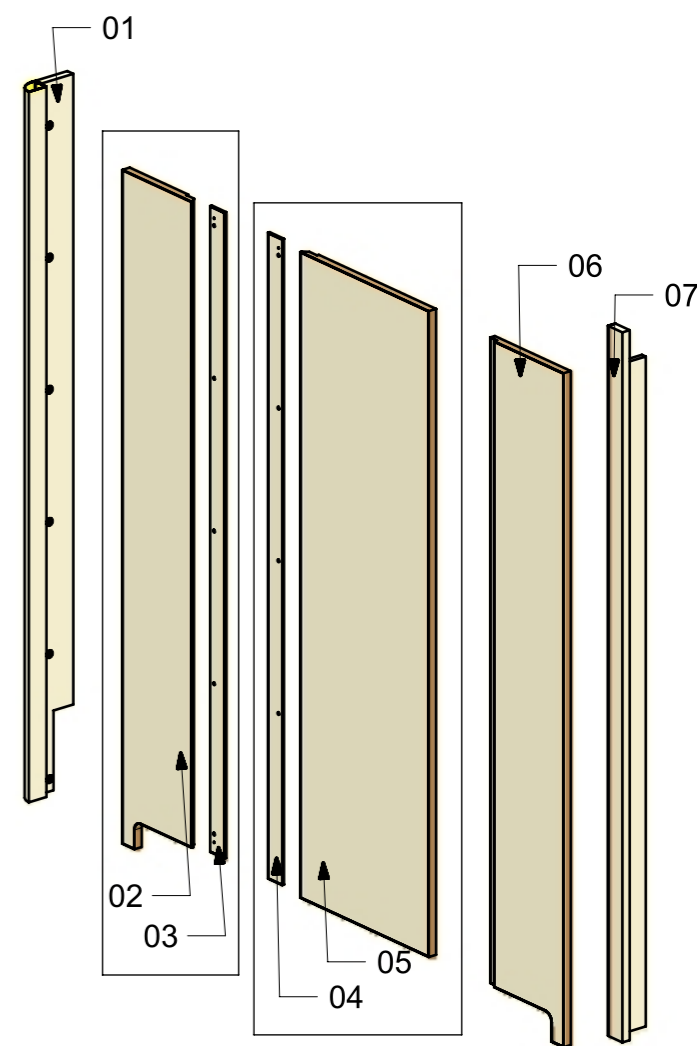

VERNICIATURA LASTRA/LACCATI:

● = VERNICIARE 1 LATO + FILI RASATI O BORDATI

NESSUN SIMBOLO = VERNICIARE 2 LATI + FILI RASATI O BORDATI

LOCALE	CODICE	DESCRIZIONE COMPONENTE	FINITURA	GR.
CUCINA	MD320_R02_KN01	PLENUM MOBILE BICCHIERI	LAISTRA CHIARA	PTP

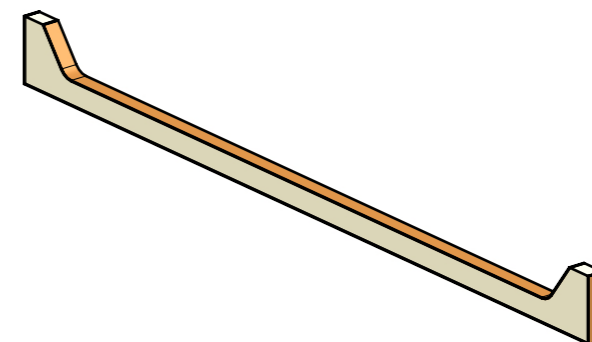
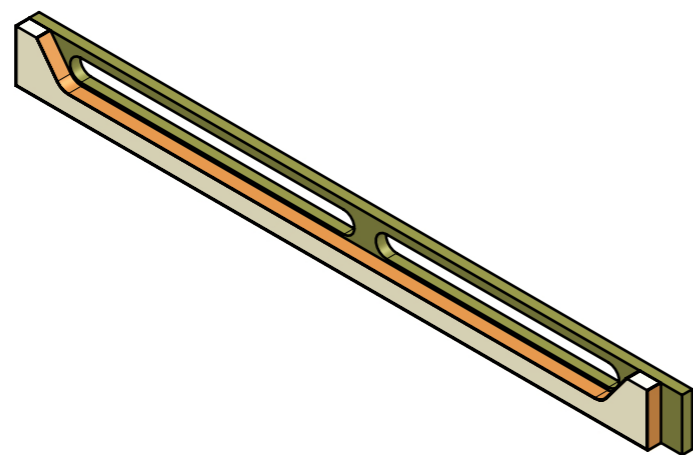

ELEMENTI DA MONTARE in MF\_KN01  
e spedire con unico imballo

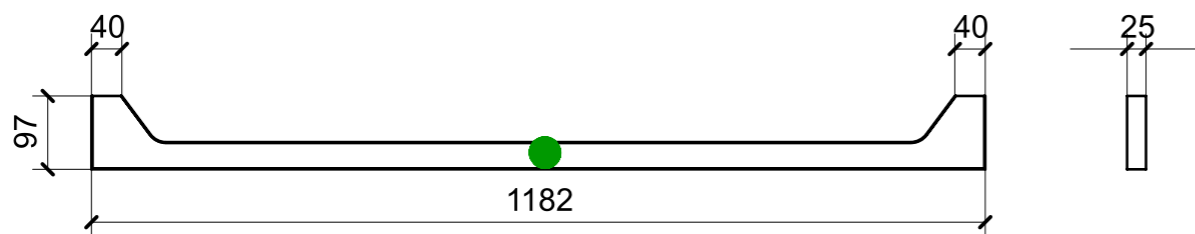

VERNICIATURA LASTRA/LACCATI:

● = FILI RASATI

● = VERNICIARE 1 LATO + FILI RASATI O BORDATI

NESSUN SIMBOLO = VERNICIARE 2 LATI + FILI RASATI O BORDATI

LOCALE	CODICE	DESCRIZIONE COMPONENTE	FINITURA	GR.
CUCINA	MD320_R01_KO01	CASSA FRIGO AGGIUNTIVO	LASTRA SCURA	2

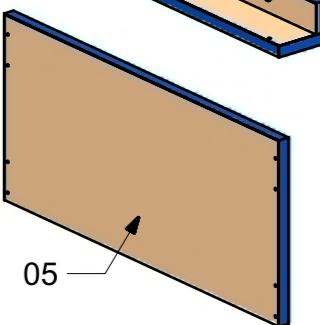
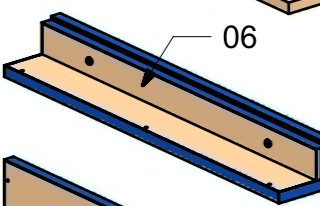
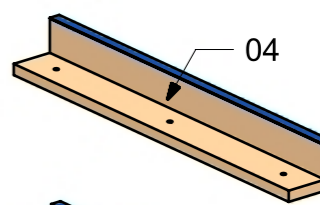
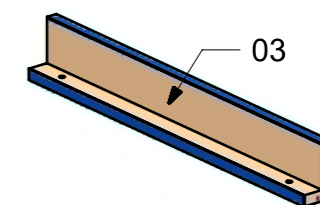
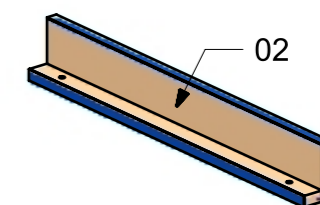
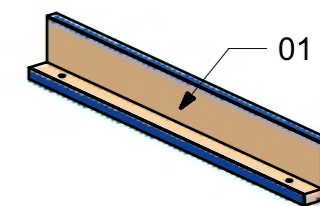
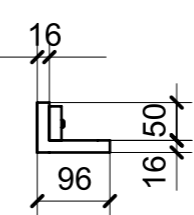
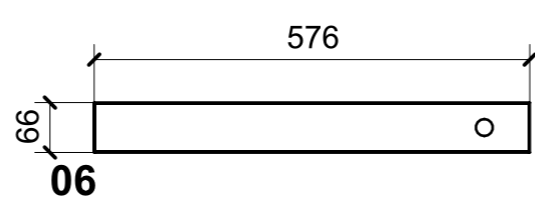
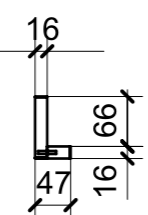
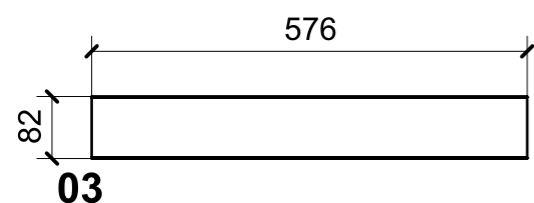
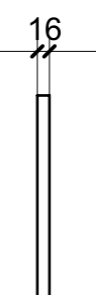
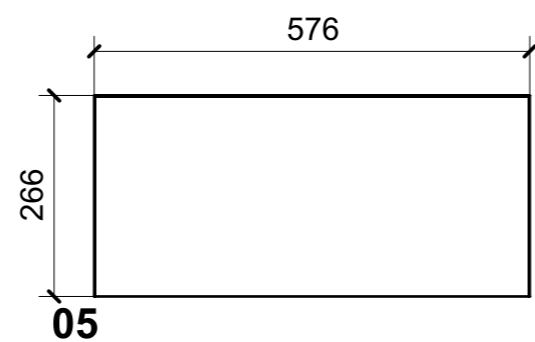
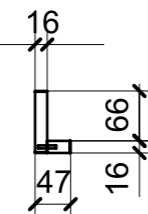
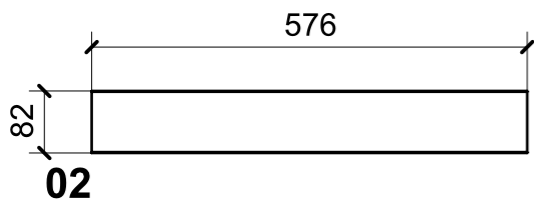
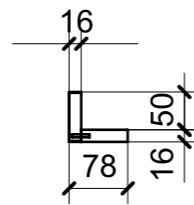
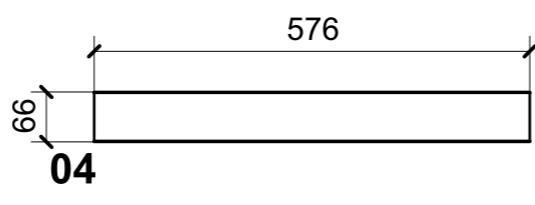
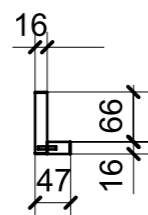
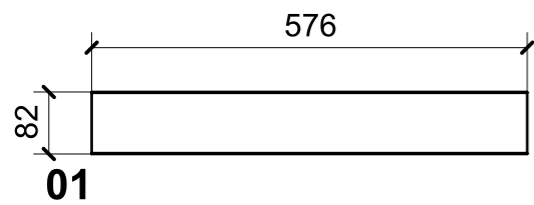

FERRAMENTA	QTY
VITE 6MA X 25 TESTA BOMBATA NERA BHCS 10.9 ISO 7380	2
MAGNETE FORZA MAGNETICA1-5 10KG_HAFELE_246.87.112	1

VERNICIATURA LASTRA/LACCATI:

● = VERNICIARE 1 LATO + FILI RASATI O BORDATI

NESSUN SIMBOLO = VERNICIARE 2 LATI + FILI RASATI O BORDATI

LOCALE	CODICE	DESCRIZIONE COMPONENTE	FINITURA	GR.
CUCINA	MD320_R02_KO01	CASSA FRIGO AGGIUNTIVO	LASTRA CHIARA	2

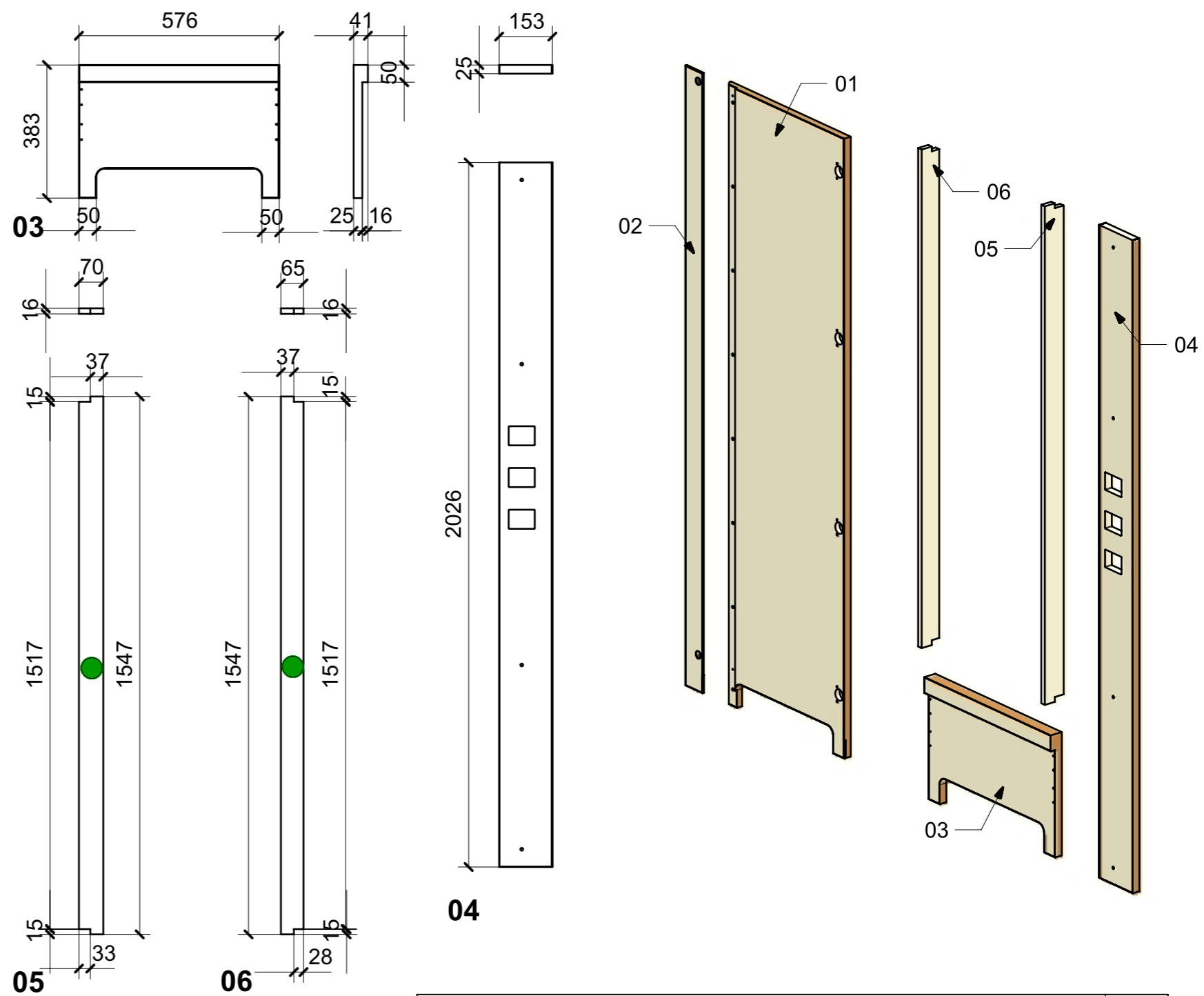
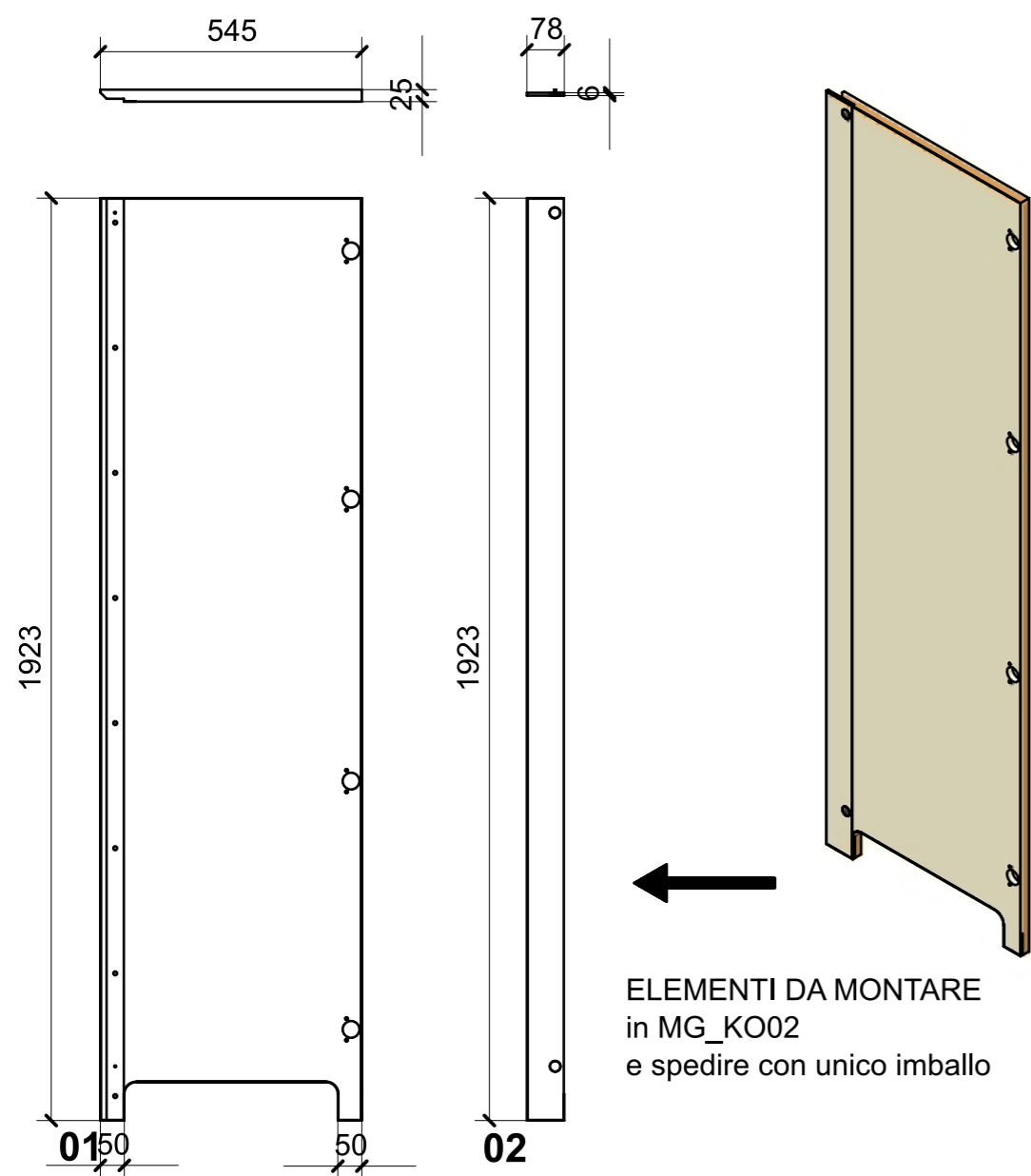

FERRAMENTA	QTY
BUSSOLA 5MA ANKOR BORGHINI X CERNIERA COLLO PIENO	8
MAGNETE FORZA MAGNETICA1-5 10KG_HAFELE_246.87.112	2

VERNICIATURA LASTRA/LACCATI:

● = VERNICIARE 1 LATO + FILI RASATI O BORDATI

NESSUN SIMBOLO = VERNICIARE 2 LATI + FILI RASATI O BORDATI

LOCALE	CODICE	DESCRIZIONE COMPONENTE	FINITURA	GR.
CUCINA	MD320_R02_KP01	CASSA RICIRCOLO ARIA FRIGO AGGIUNTO	LASTRA CHIARA	PTP

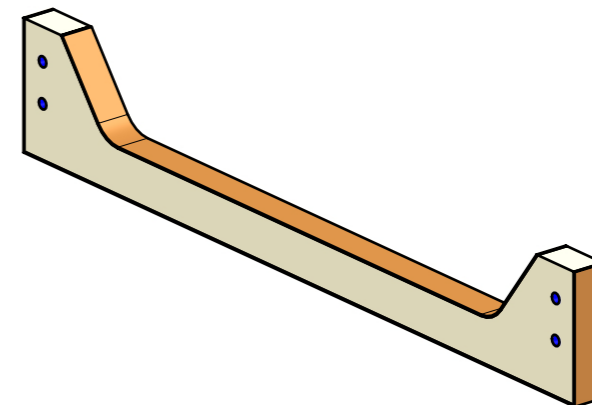
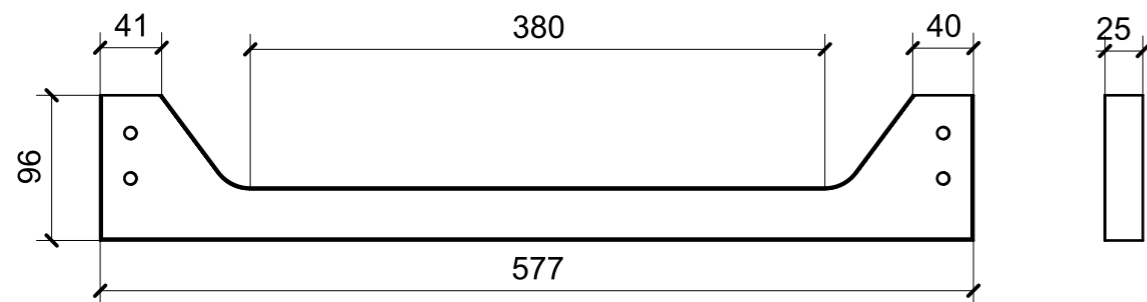

ELEMENTO DA MONTARE in MF\_KP01  
e spedire con unico imballo

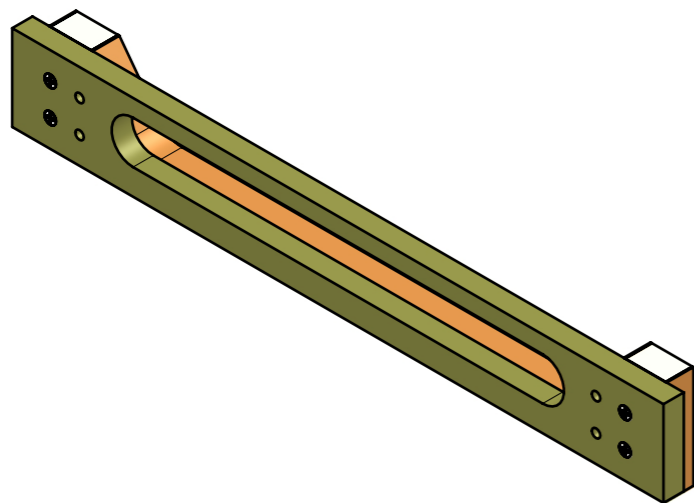

FERRAMENTA	QTY
BUSSOLA 6MA X 10 FORO DIAM.8	4
VITE 6MA X 25 TESTA SVASATA	4

VERNICIATURA LASTRA/LACCATI:

● = FILI RASATI

● = VERNICIARE 1 LATO + FILI RASATI O BORDATI

NESSUN SIMBOLO = VERNICIARE 2 LATI + FILI RASATI O BORDATI

LOCALE	CODICE	DESCRIZIONE COMPONENTE	FINITURA	GR.
CUCINA	MD320_R02_KS01	RIV. LATO DX BASE PENSILE DI PRUA	LASTRA CHIARA	2

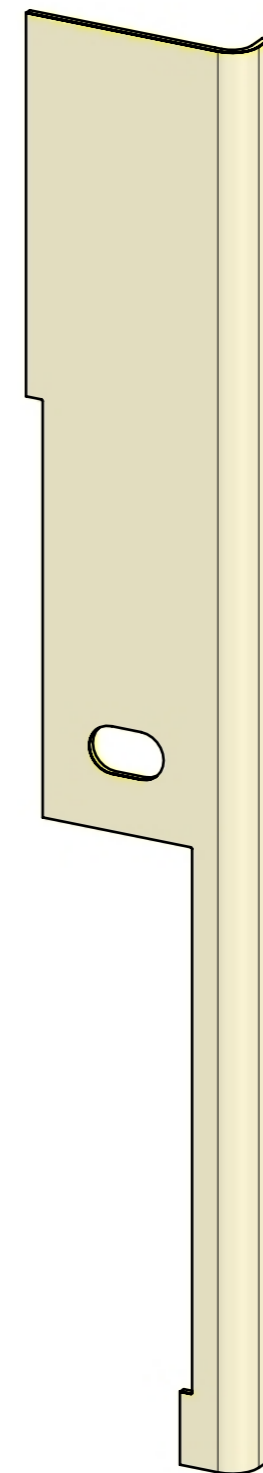
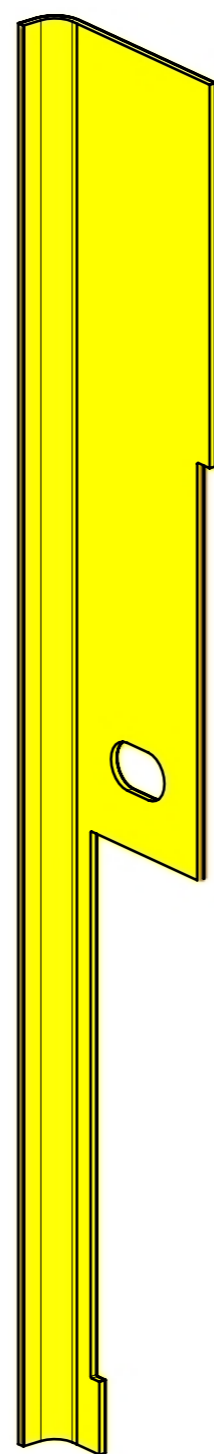
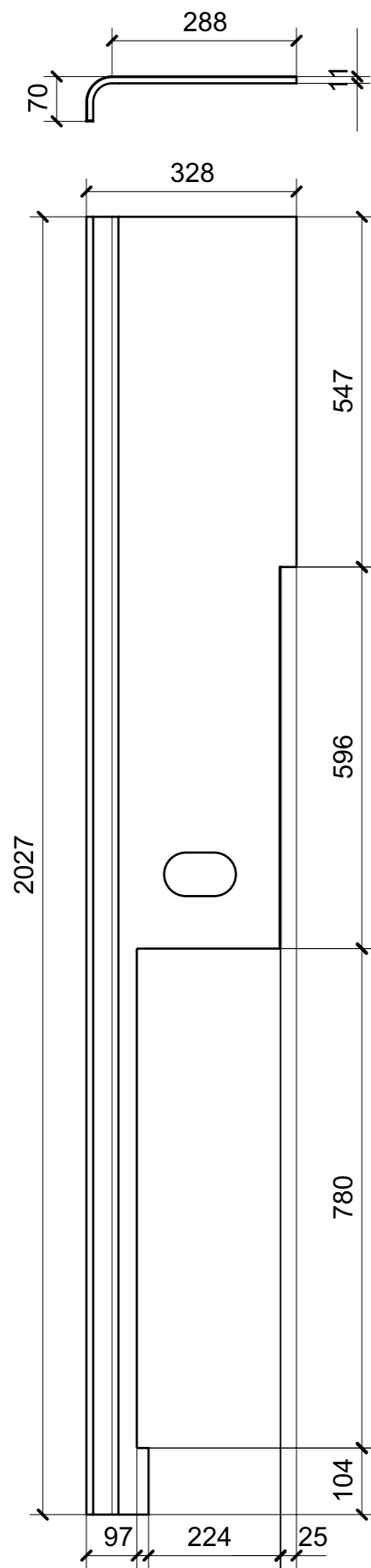

VERNICIATURA LASTRA/LACCATI:

● = VERNICIARE 1 LATO + FILI RASATI O BORDATI

NESSUN SIMBOLO = VERNICIARE 2 LATI + FILI RASATI O BORDATI

LOCALE	CODICE	DESCRIZIONE COMPONENTE	FINITURA	GR.
CUCINA	MD320_R02_KT01	RIV. PARATIA PORTA SCORR. DAILY TOILET	LASTRA CHIARA	PTP

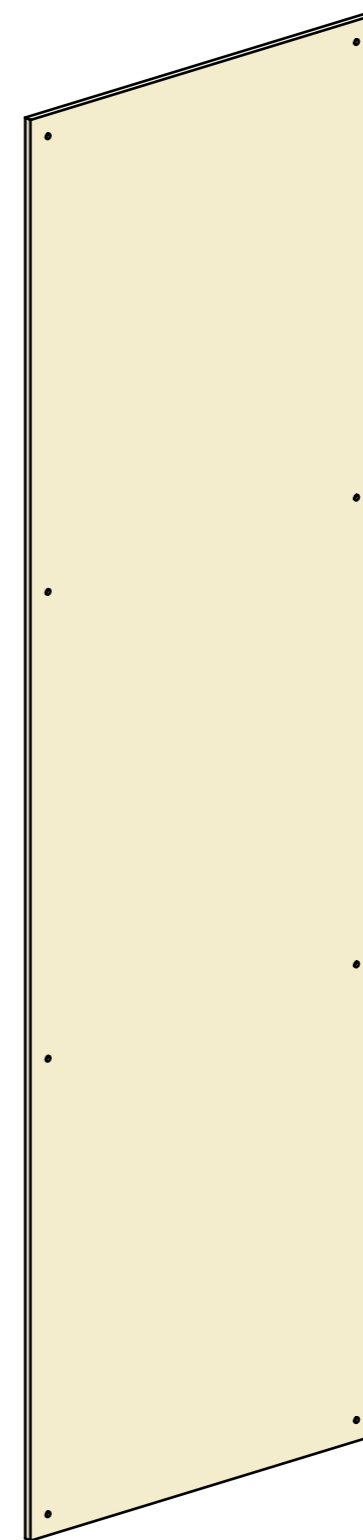
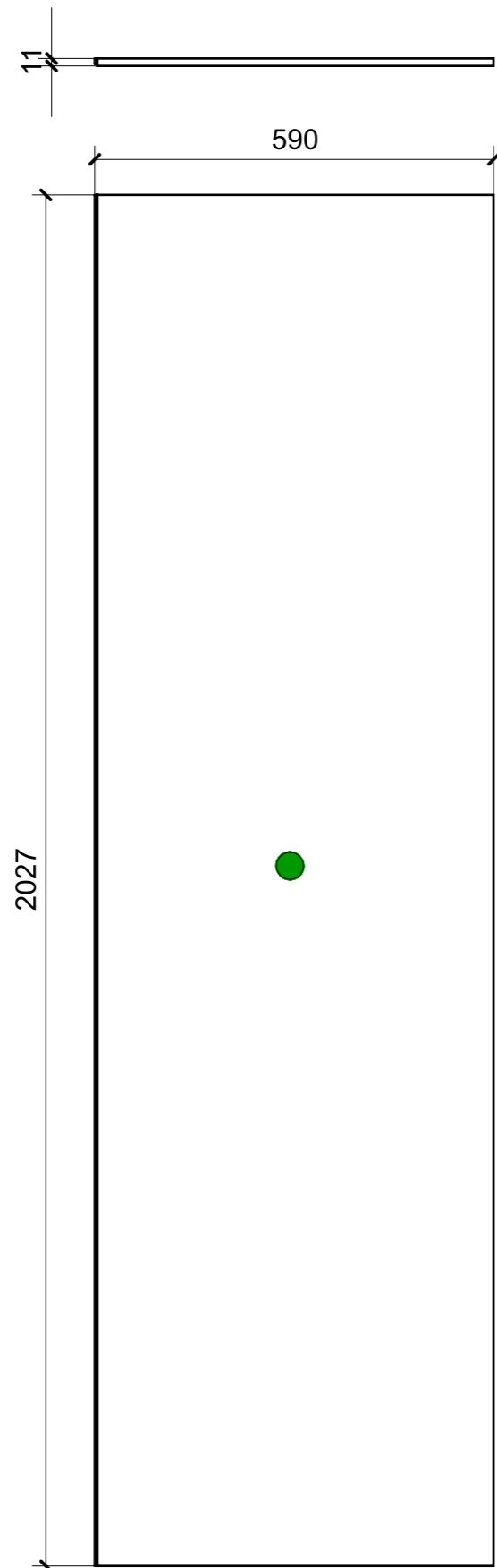

VERNICIATURA LASTRA/LACCATI:

● = FILI RASATI

● = VERNICIARE 1 LATO + FILI RASATI O BORDATI

NESSUN SIMBOLO = VERNICIARE 2 LATI + FILI RASATI O BORDATI

LOCALE	CODICE	DESCRIZIONE COMPONENTE	FINITURA	GR.
CUCINA	MD320_R02_KU01	RIV. PARATIA INGRESSO CUCINA	LASTRA CHIARA	2

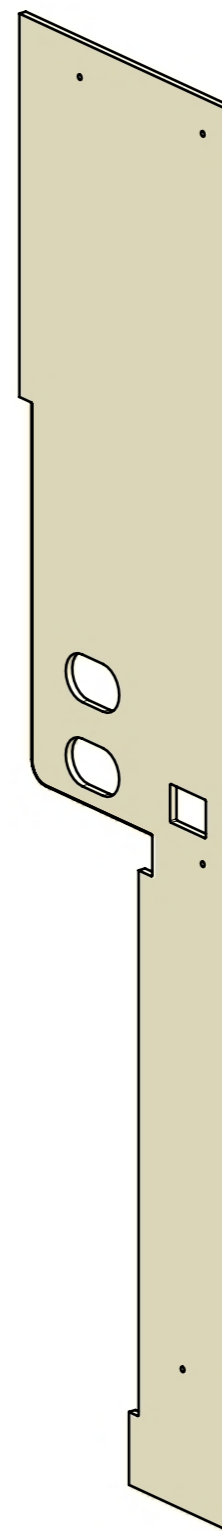
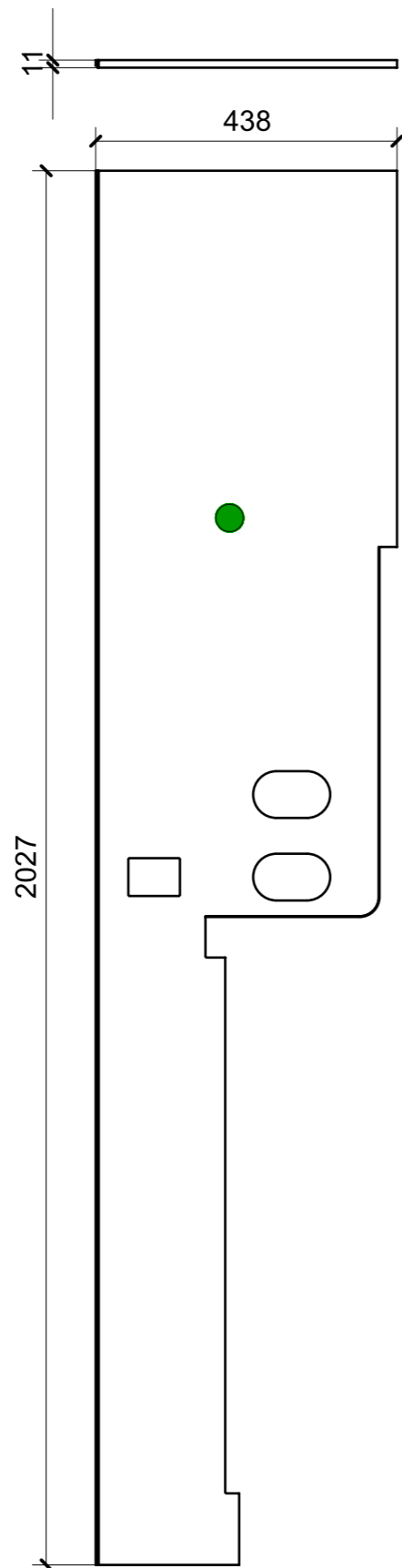

VERNICIATURA LASTRA/LACCATI:

● = VERNICIARE 1 LATO + FILI RASATI O BORDATI

NESSUN SIMBOLO = VERNICIARE 2 LATI + FILI RASATI O BORDATI

LOCALE	CODICE	DESCRIZIONE COMPONENTE	FINITURA	GR.
CUCINA	MD320_R02_KV01	RIV. INFERIORE PORTA SCORREVOLE CUCINA	LASTRA CHIARA	PTP

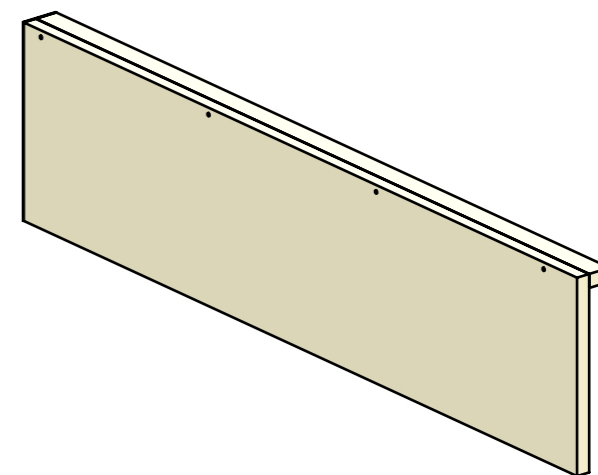
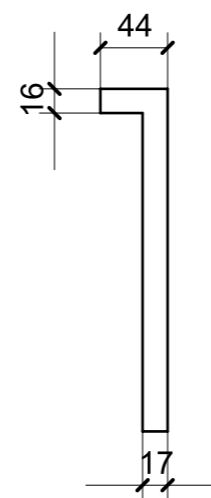
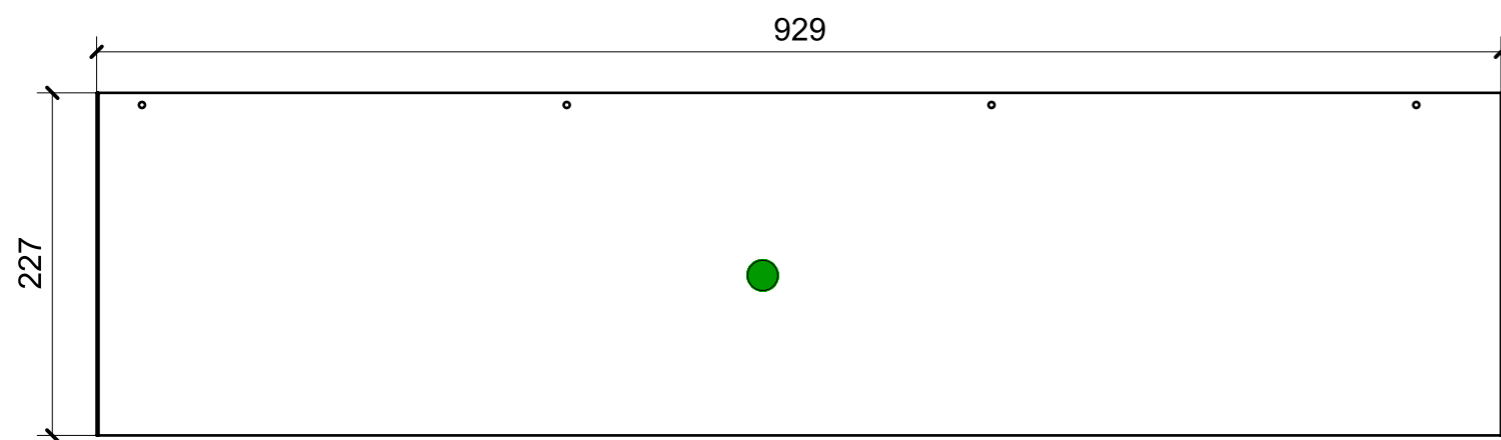

VERNICIATURA LASTRA/LACCATI:

● = FILI RASATI

● = VERNICIARE 1 LATO + FILI RASATI O BORDATI

NESSUN SIMBOLO = VERNICIARE 2 LATI + FILI RASATI O BORDATI