

LOCALE	CODICE	DESCRIZIONE COMPONENTE	FINITURA	GR.
DAILY TOILET	MD320_L02_DB01	PENSILE SOPRA WC	LACCATO NCS- S - 1002-Y -MANOPESCA	PTP

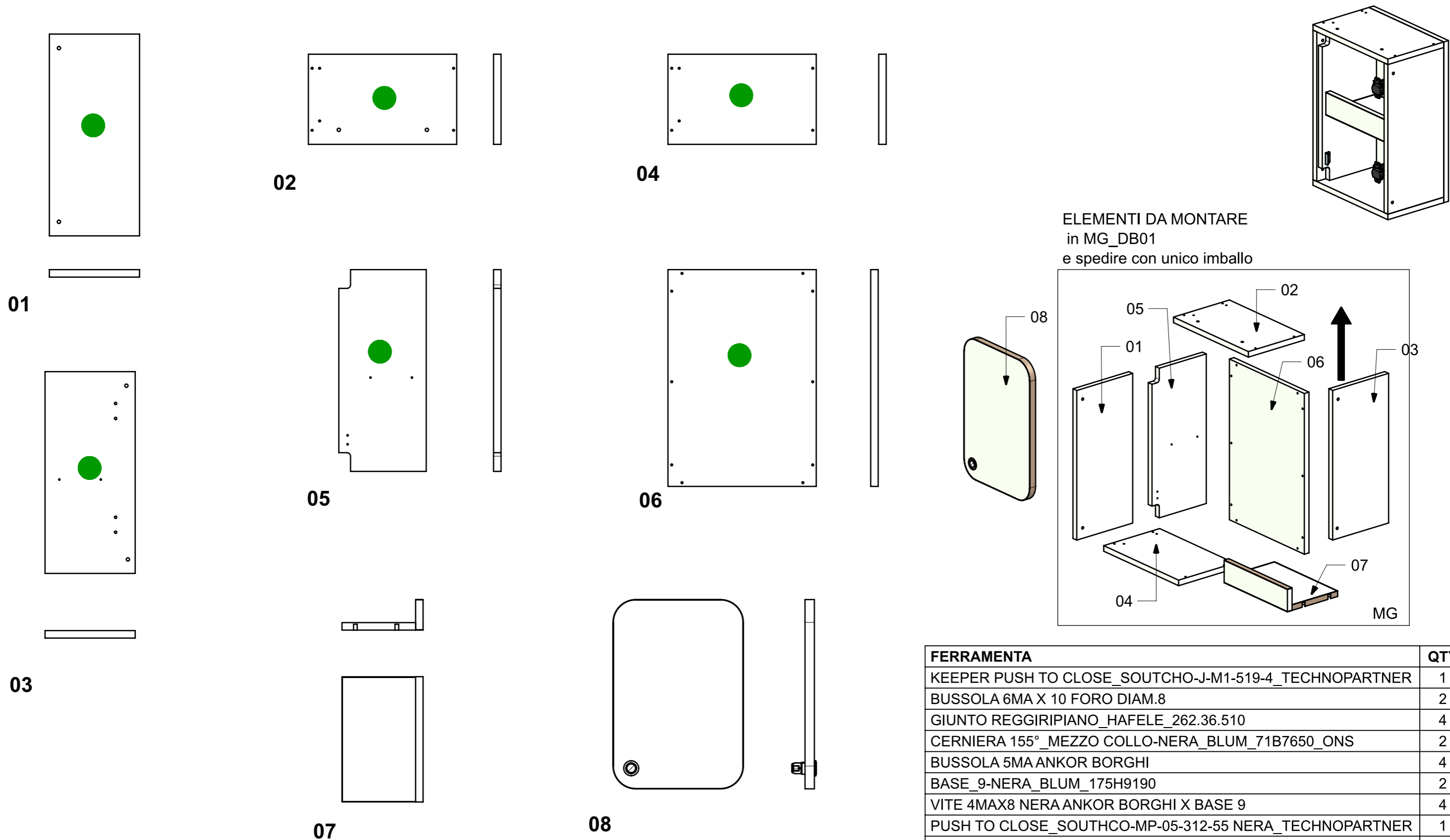

ELEMENTI DA MONTARE
in MG_DB01
e spedire con unico imballo

FERRAMENTA	QTY
KEEPER PUSH TO CLOSE_SOUTCHO-J-M1-519-4_TECHNOPARTNER	1
BUSSOLA 6MA X 10 FORO DIAM.8	2
GIUNTO REGGIRIPIANO_HAFELE_262.36.510	4
CERNIERA 155°_MEZZO COLLO-NERA_BLUM_71B7650_ONS	2
BUSSOLA 5MA ANKOR BORGHI	4
BASE_9-NERA_BLUM_175H9190	2
VITE 4MAX8 NERA ANKOR BORGHI X BASE 9	4
PUSH TO CLOSE_SOUTHCO-MP-05-312-55 NERA_TECHNOPARTNER	1
BUSSOLA 5MA ANKOR BORGHI X CERNIERA COLLO PIENO	4

VERNICIATURA LASTRA/LACCATI:

● = FILI RASATI

● = VERNICIARE 1 LATO + FILI RASATI O BORDATI

NESSUN SIMBOLO = VERNICIARE 2 LATI + FILI RASATI O BORDATI

LOCALE	CODICE	DESCRIZIONE COMPONENTE	FINITURA	GR.
DAILY TOILET	MD320_L01_DC01	RIVESTIMENTO PARATIA PENSILE	LACCATO BRONZO	PTP

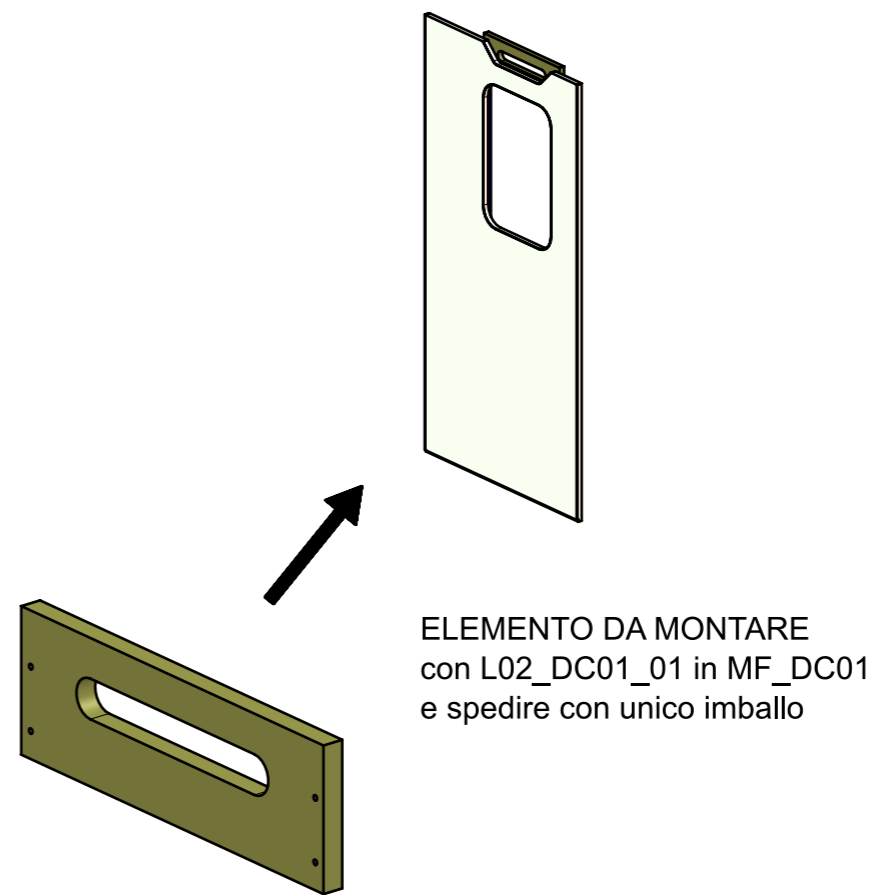
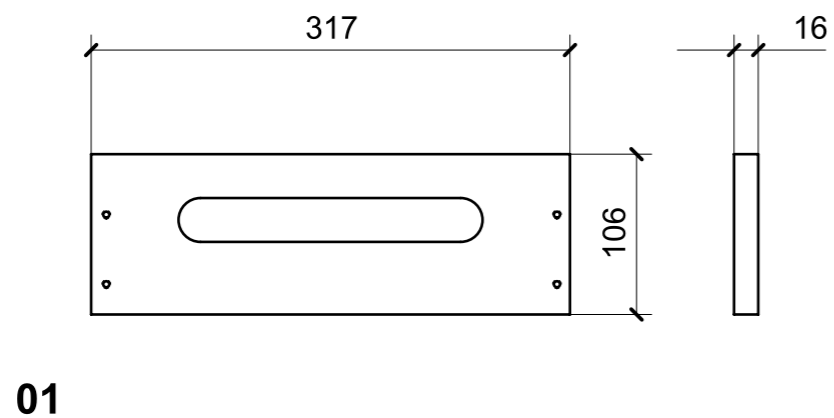

● = FILI RASATI

VERNICIATURA LASTRA/LACCATI:

● = VERNICIARE 1 LATO + FILI RASATI O BORDATI

NESSUN SIMBOLO = VERNICIARE 2 LATI + FILI RASATI O BORDATI

LOCALE	CODICE	DESCRIZIONE COMPONENTE	FINITURA	GR.
DAILY TOILET	MD320_L02_DC01	RIVESTIMENTO PARATIA PENSILE	LACCATO NCS- S - 1002-Y -MANOPESCA	PTP

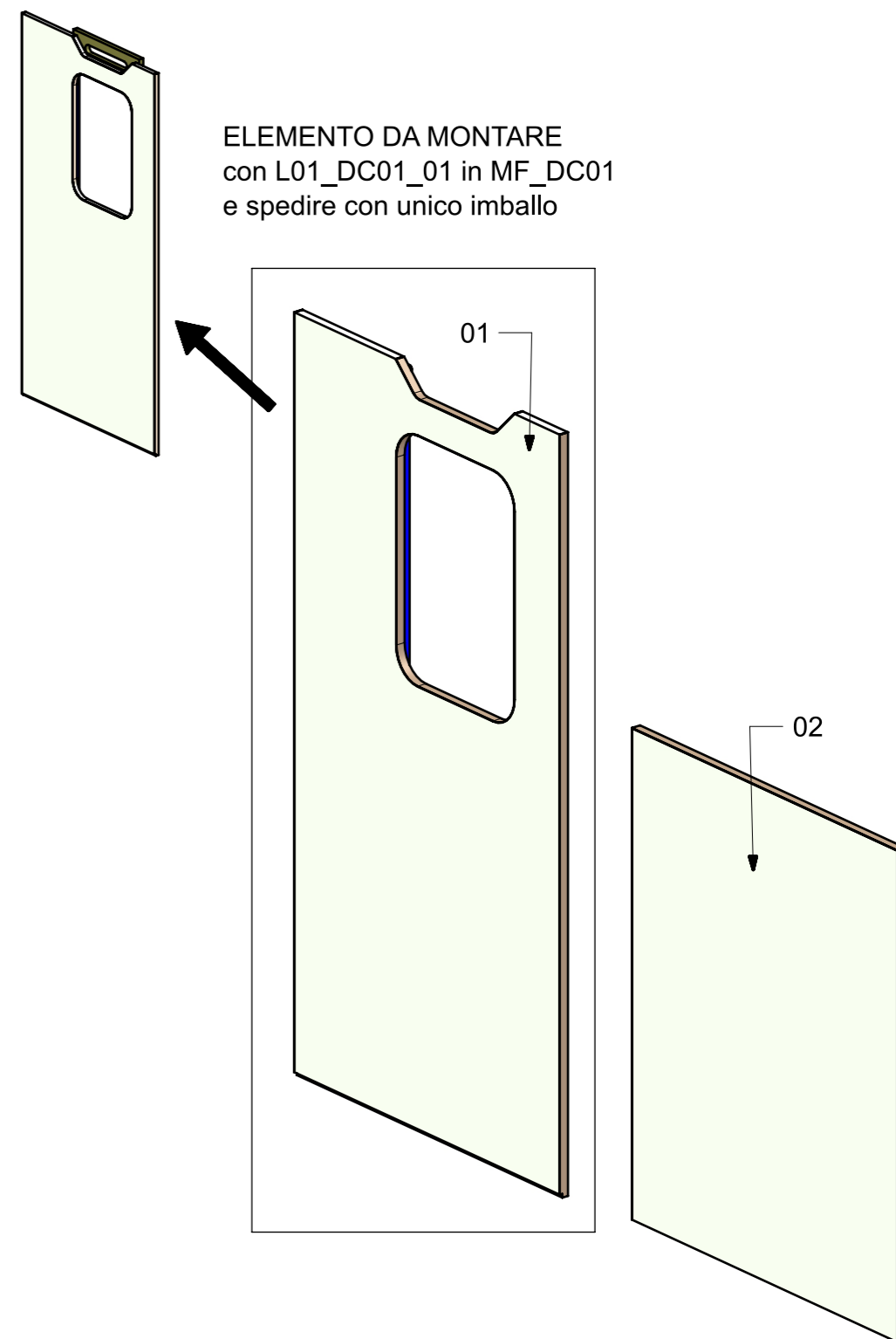
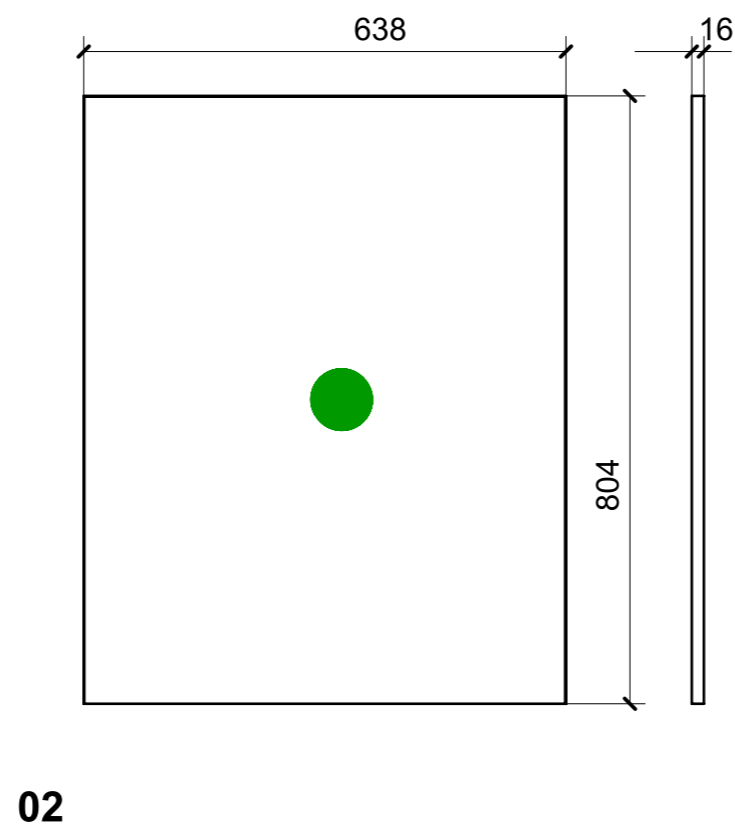
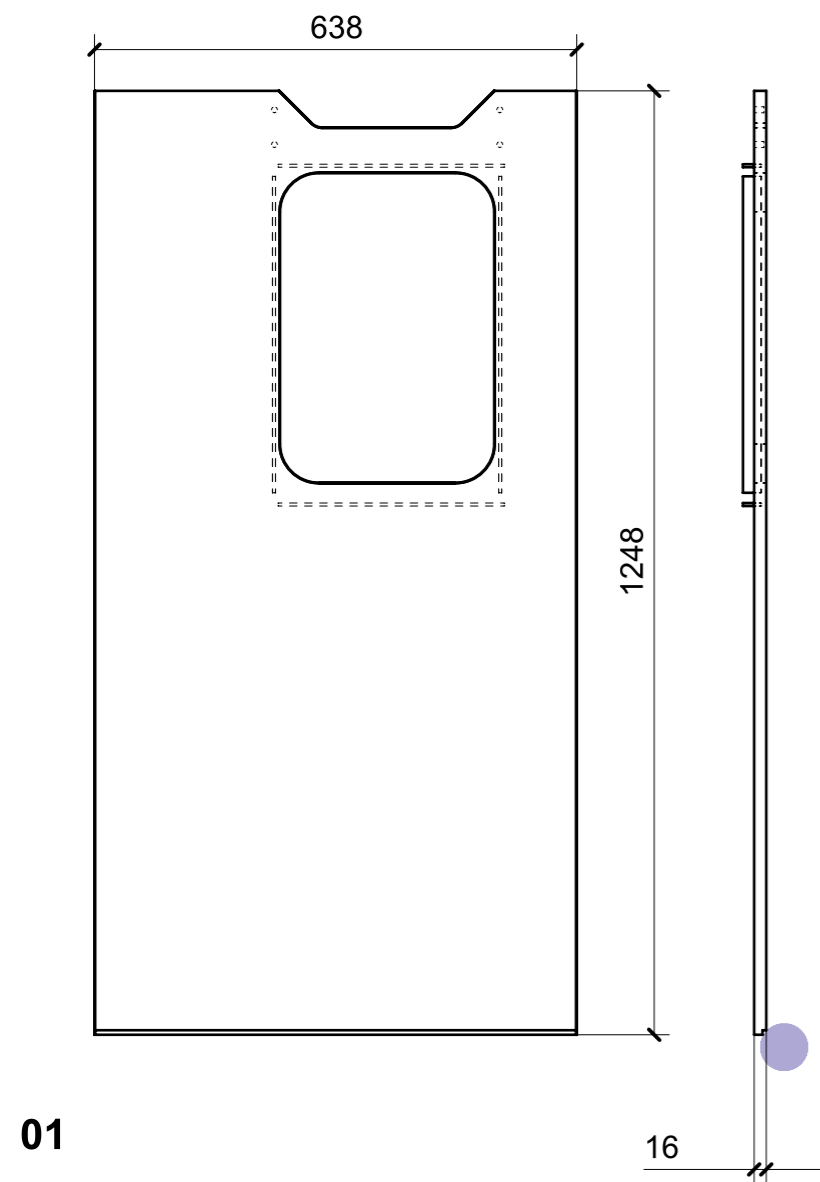

FERRAMENTA	QTY
VITE 6MA X 25 TESTA SVASATA NERA	4
BUSSOLA 6MA X 10 FORO DIAM.8	4

VERNICIATURA LASTRA/LACCATI:

● = FILI RASATI

● = VERNICIARE 1 LATO + FILI RASATI O BORDATI

NESSUN SIMBOLO = VERNICIARE 2 LATI + FILI RASATI O BORDATI

LOCALE	CODICE	DESCRIZIONE COMPONENTE	FINITURA	GR.
DAILY TOILET	MD320_L02_DD01	RIVESTIMENTI PARATIA DISCESA SCALE	LACCATO NCS- S - 1002-Y -MANOPESCA	PTP

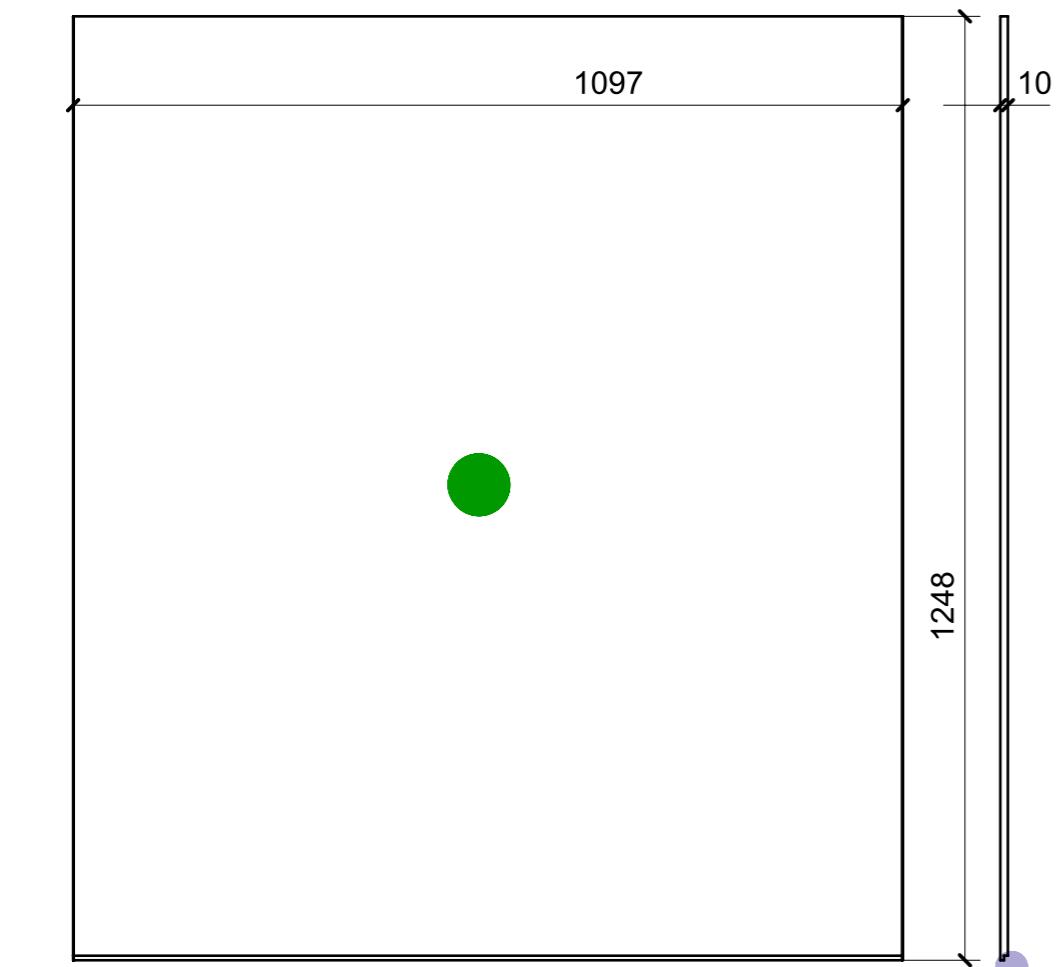

02

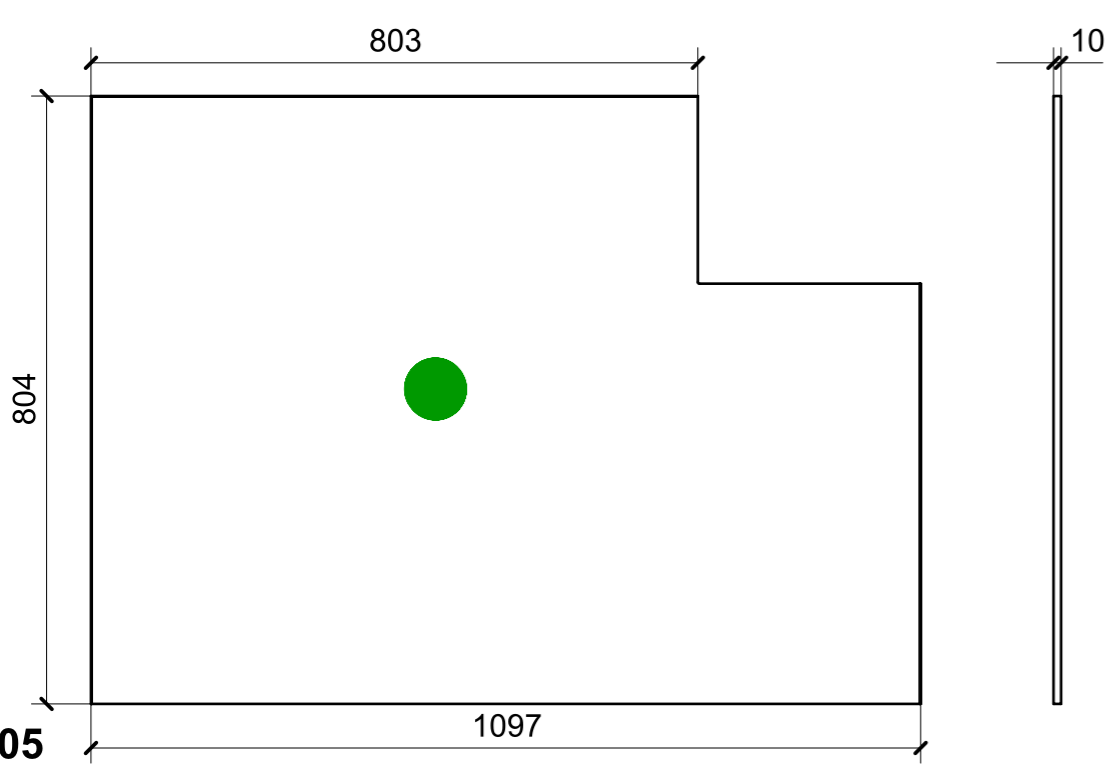

05

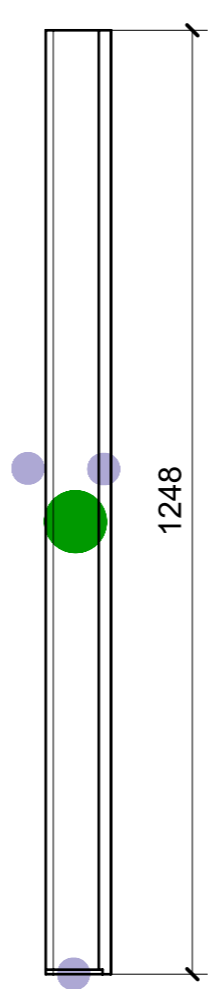

01

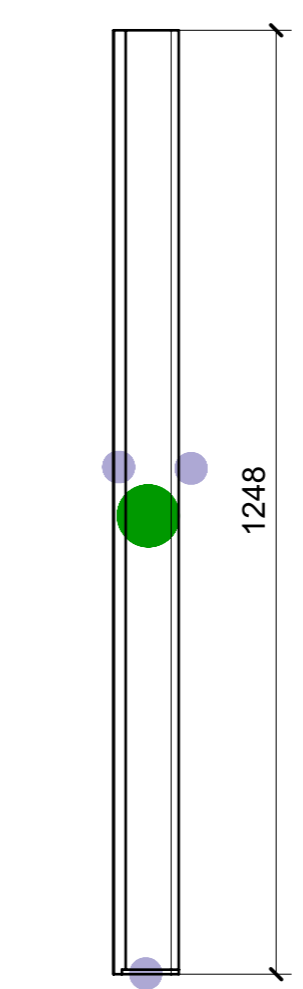

03

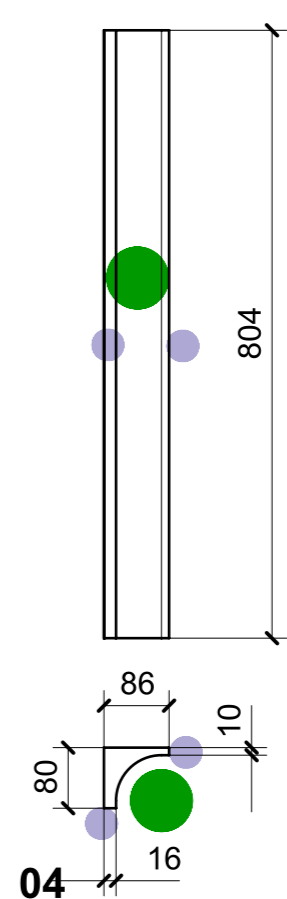

04

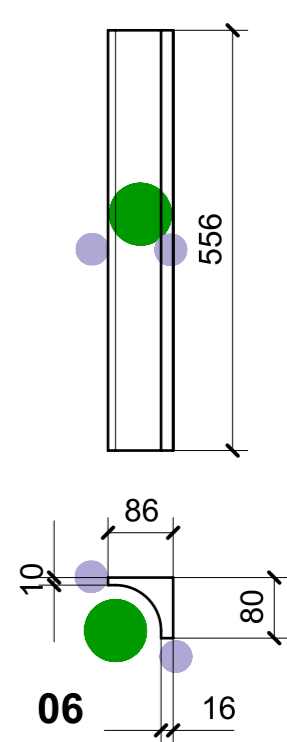

06

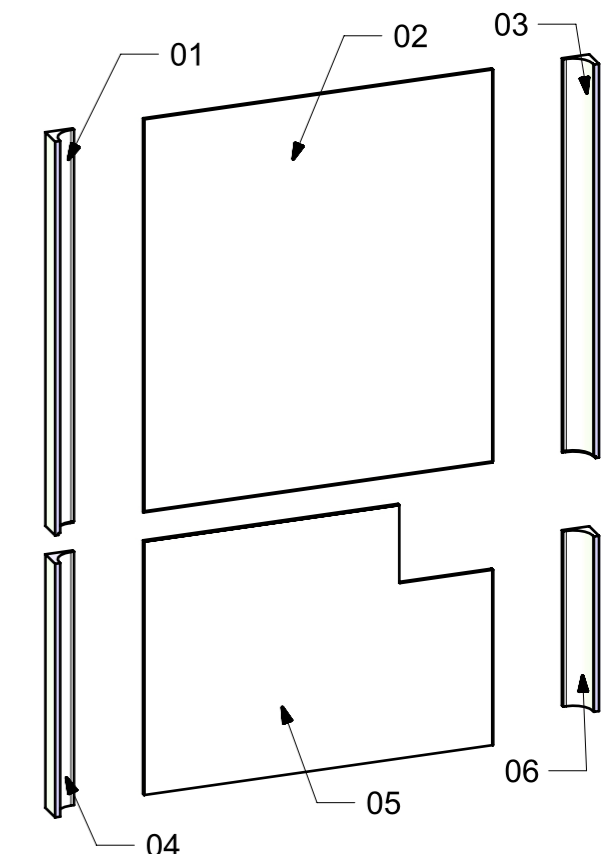

VERNICIATURA LASTRA/LACCATI:
 ● = FILI RASATI
 ● = VERNICIARE 1 LATO + FILI RASATI O BORDATI
 NESSUN SIMBOLO = VERNICIARE 2 LATI + FILI RASATI O BORDATI

LOCALE	CODICE	DESCRIZIONE COMPONENTE	FINITURA	GR.
DAILY TOILET	MD320_L02_DE01	RIVESTIMENTI PARATIA IMPIANTI	LACCATO NCS- S - 1002-Y -MANOPESCA	2

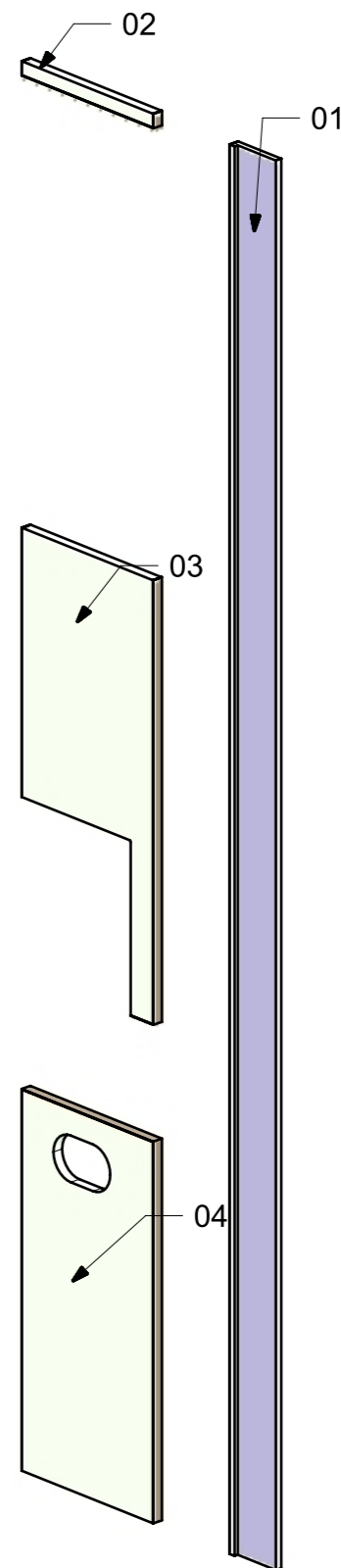
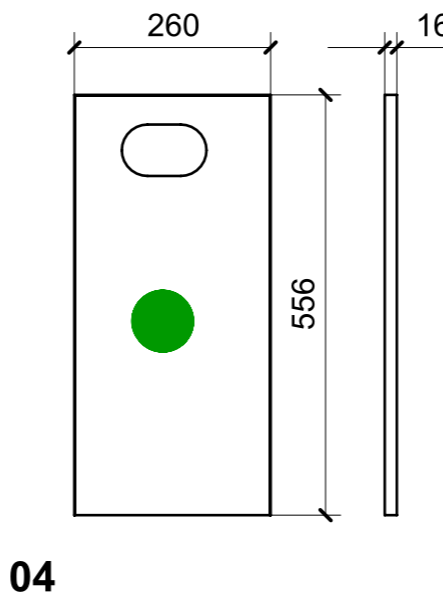
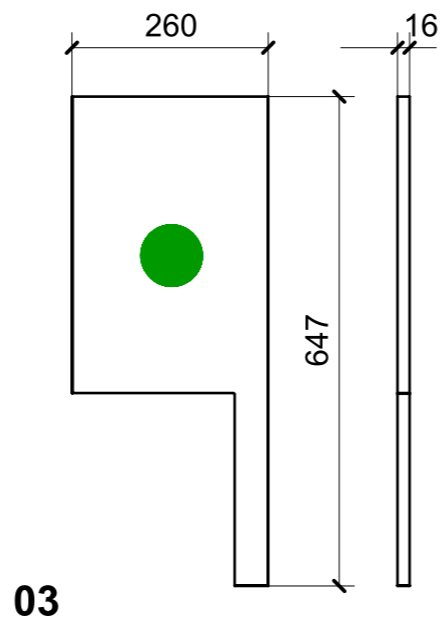
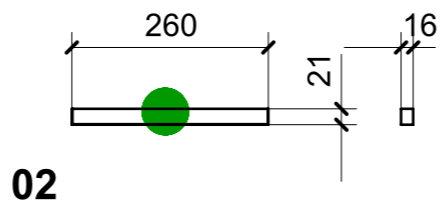
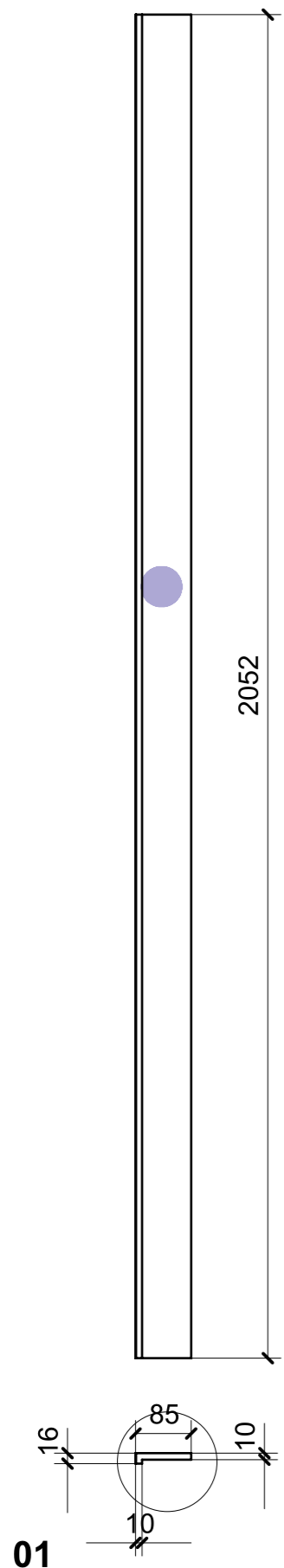

VERNICIATURA LASTRA/LACCATI:

● = FILI RASATI

● = VERNICIARE 1 LATO + FILI RASATI O BORDATI

NESSUN SIMBOLO = VERNICIARE 2 LATI + FILI RASATI O BORDATI

LOCALE	CODICE	DESCRIZIONE COMPONENTE	FINITURA	GR.
DAILY TOILET	MD320_L02_DH01	CIELINO	LACCATO NCS- S - 1002-Y -MANOPESCA	PTP

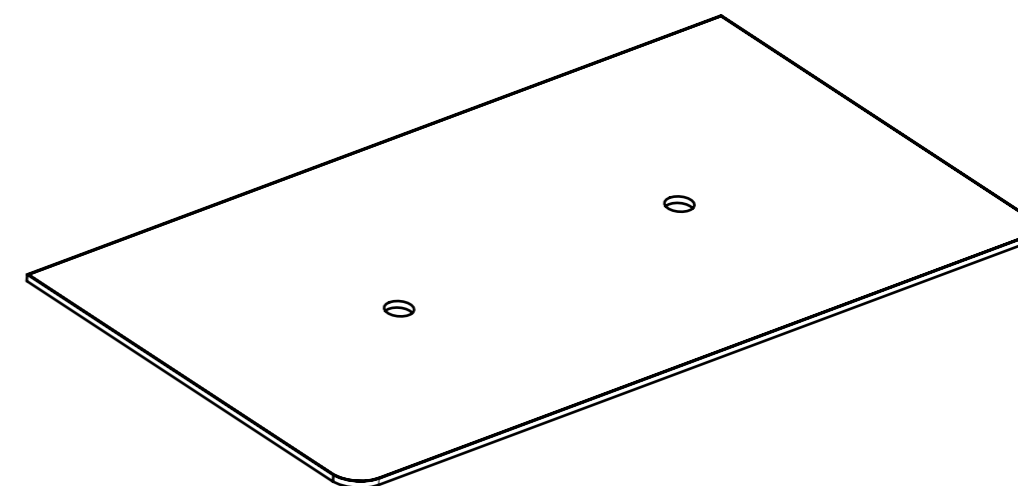
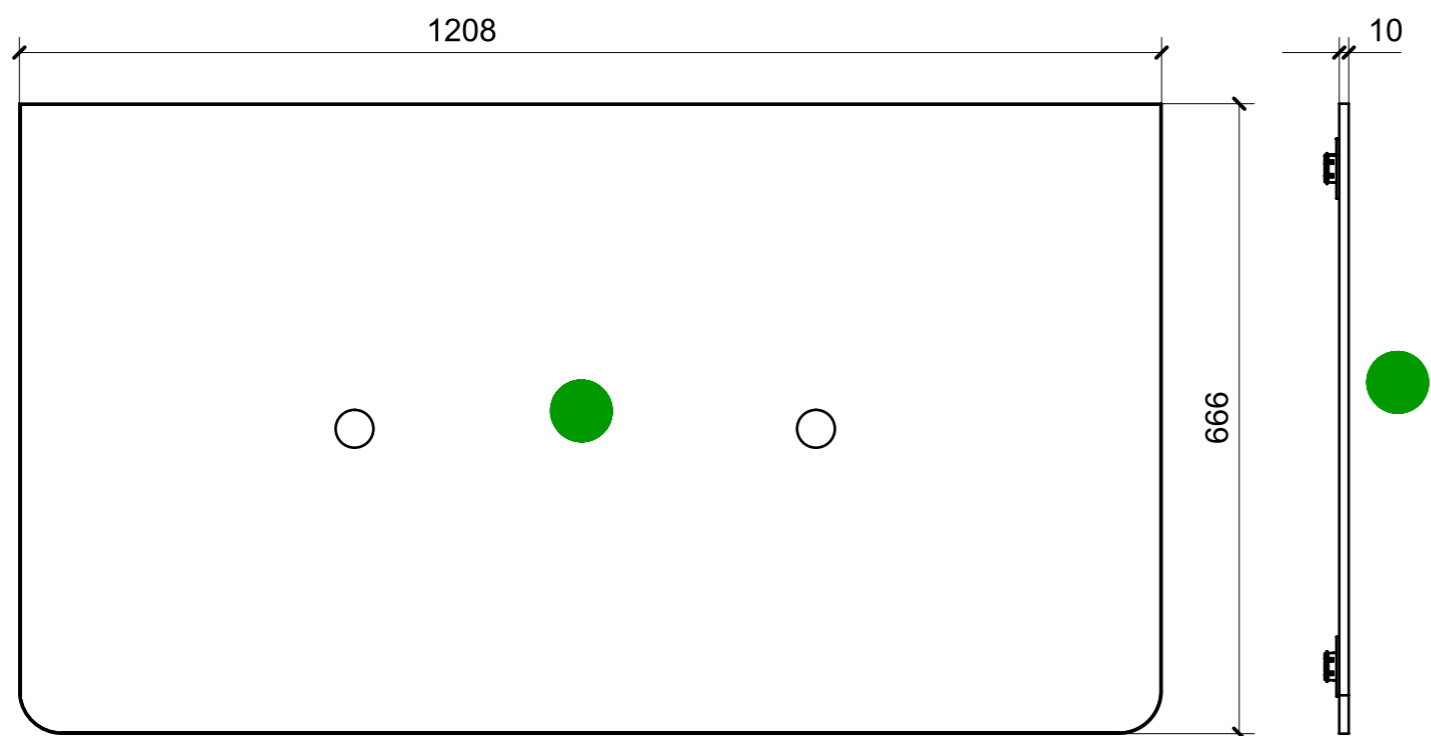

01

FERRAMENTA	QTY
FITLOCK M_MASCHERPA_3MM_6020202101	6

● = FILI RASATI
 ● = VERNICIARE 1 LATO + FILI RASATI O BORDATI
 NESSUN SIMBOLO = VERNICIARE 2 LATI + FILI RASATI O BORDATI

LOCALE	CODICE	DESCRIZIONE COMPONENTE	FINITURA	GR.
DAILY TOILET	MD320_L02_DI01	RIVESTIMENTO LAVELLO	LACCATO NCS- S - 1002-Y -MANOPESCA	PTP

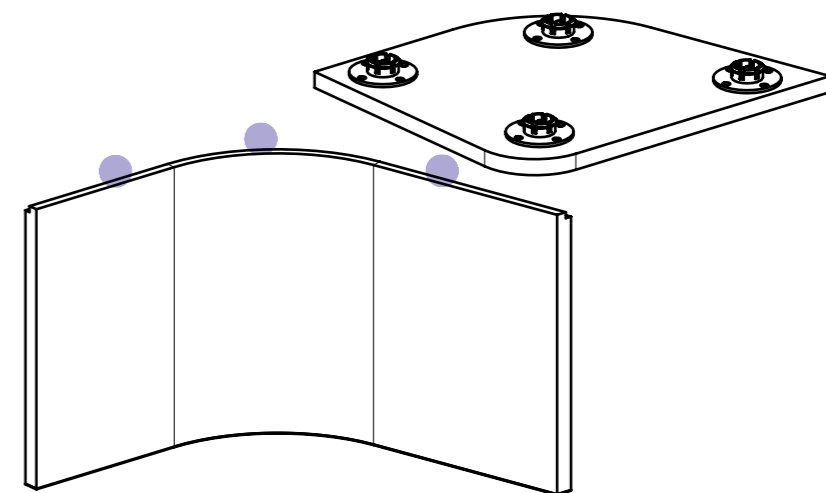
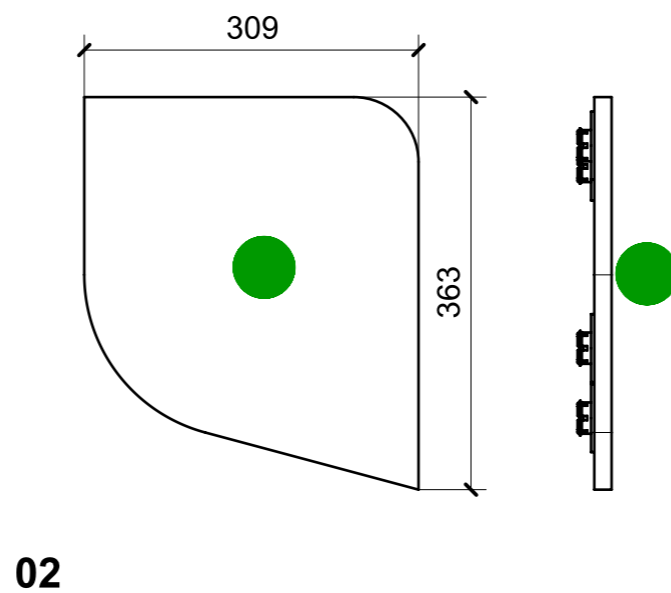
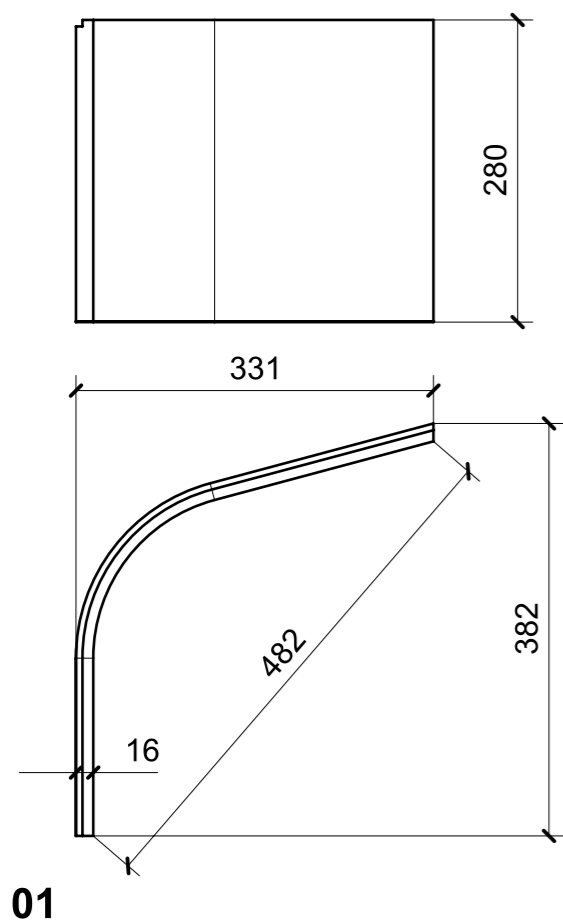

FERRAMENTA	QTY
FITLOCK M_MASCHERPA_3MM_6020202101	4

● = FILI RASATI

● = VERNICIARE 1 LATO + FILI RASATI O BORDATI

NESSUN SIMBOLO = VERNICIARE 2 LATI + FILI RASATI O BORDATI