

LOCALE	CODICE	DESCRIZIONE COMPONENTE	FINITURA	GR.
BAGNO OSPITI DX	MD320_MF_ZB01	PENSILE A MURATA		2

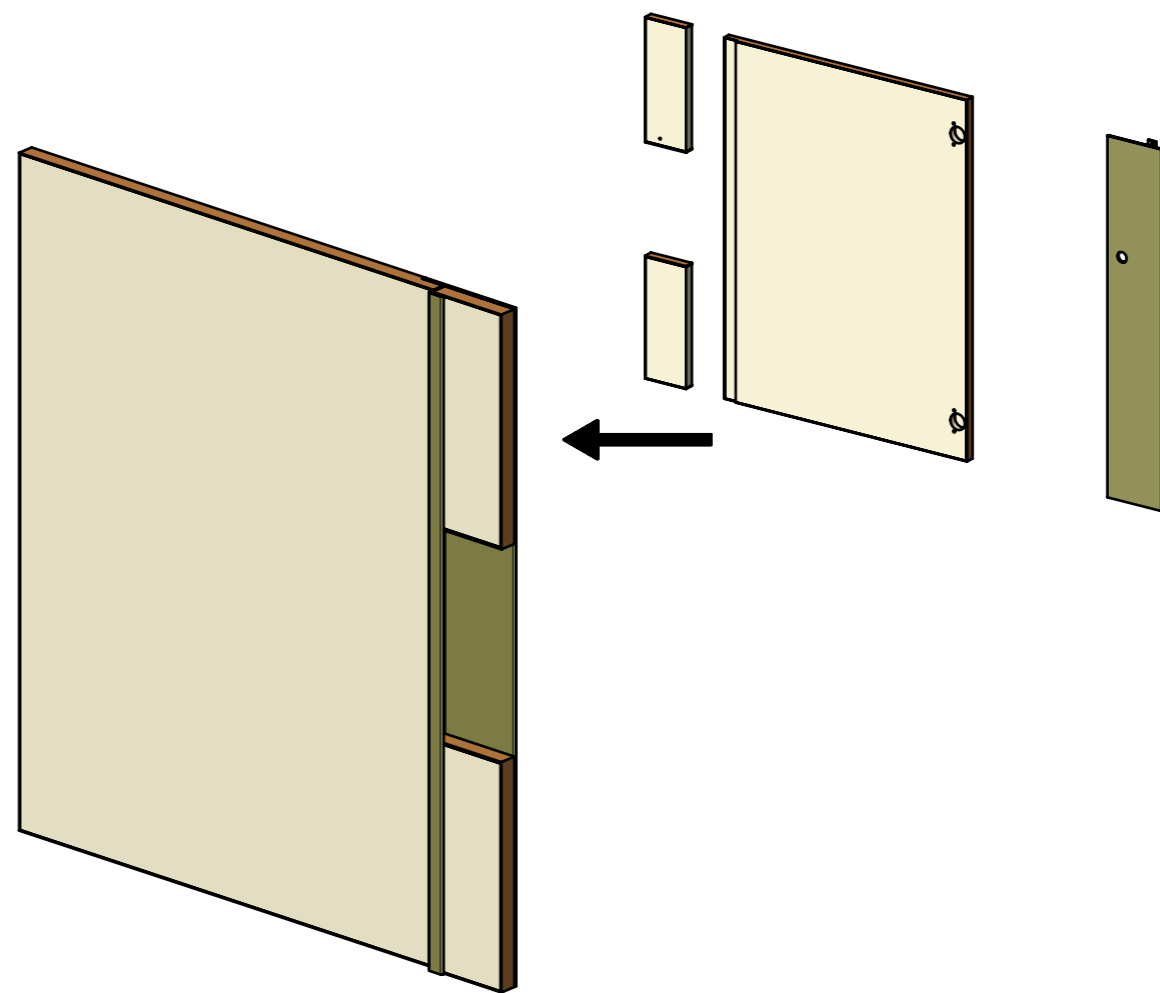

LOCALE	CODICE	DESCRIZIONE COMPONENTE	FINITURA	GR.
BAGNO OSPITI DX	MD320_MF_ZC01	RIVESTIMENTI ZONA LAVELLO		2

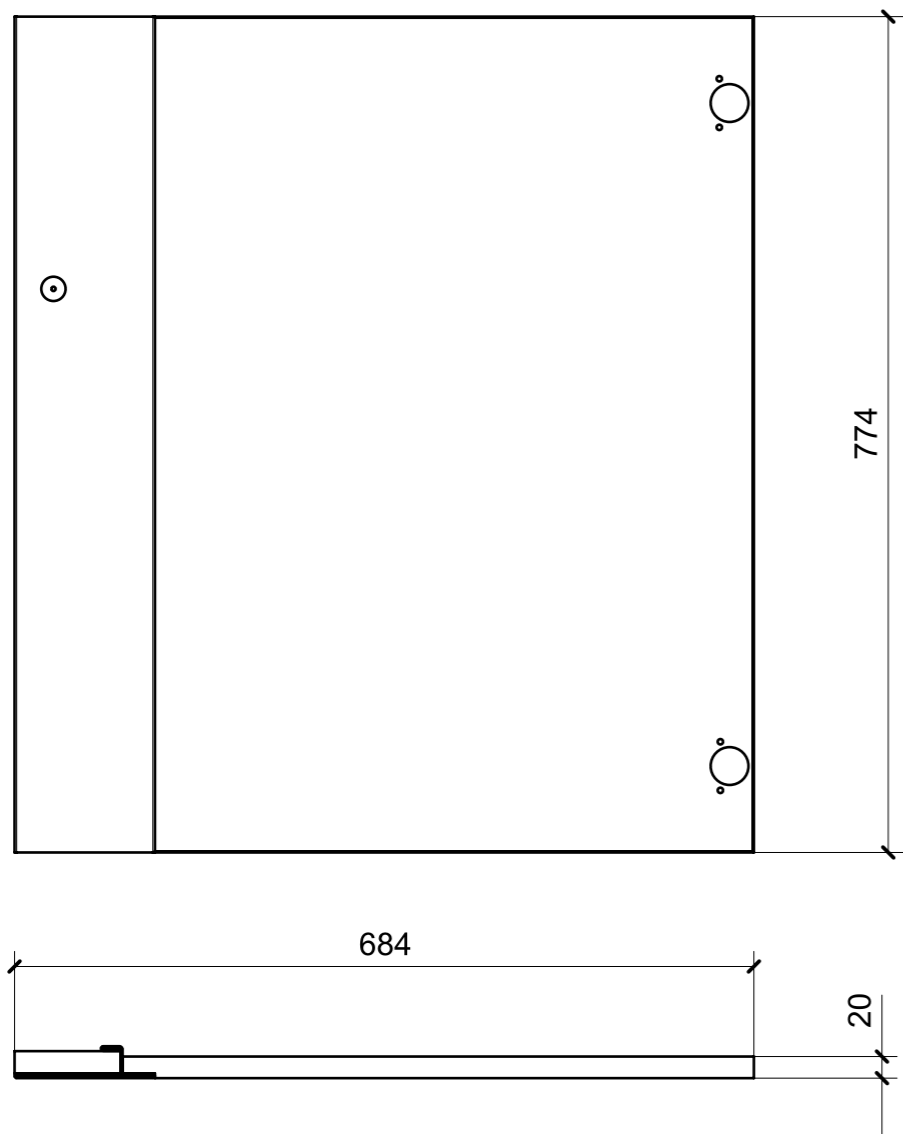
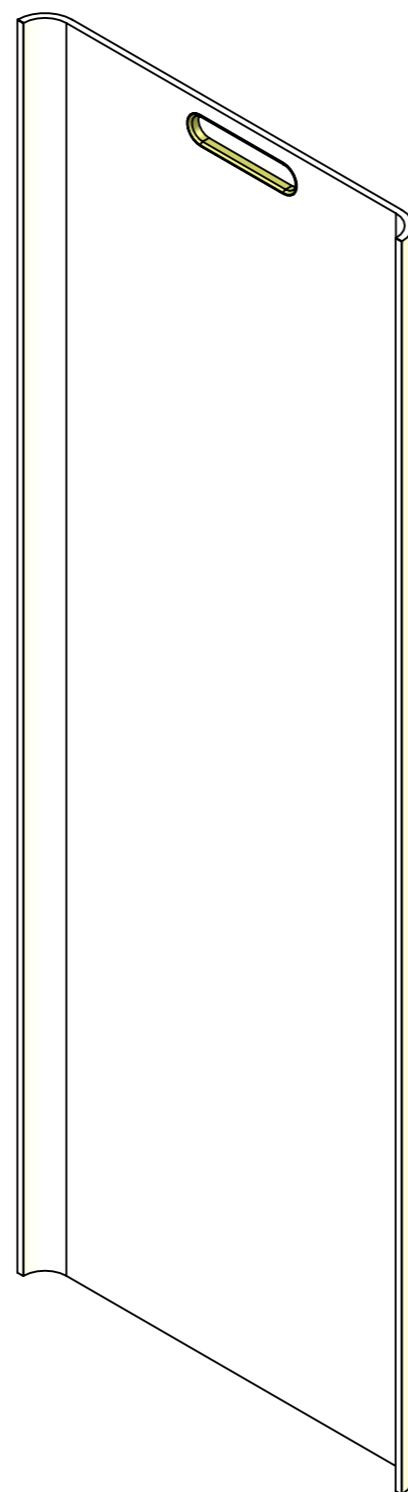
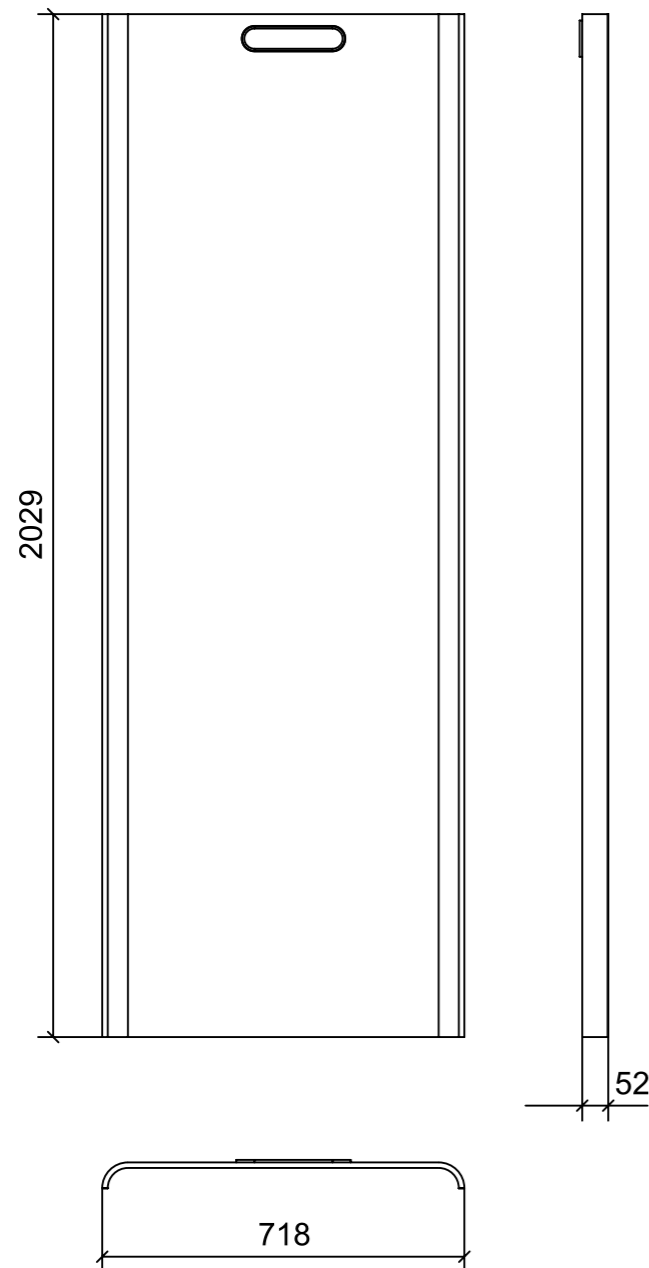

LACCATO BRONZO

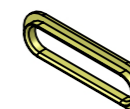

LASTRA CHIARA

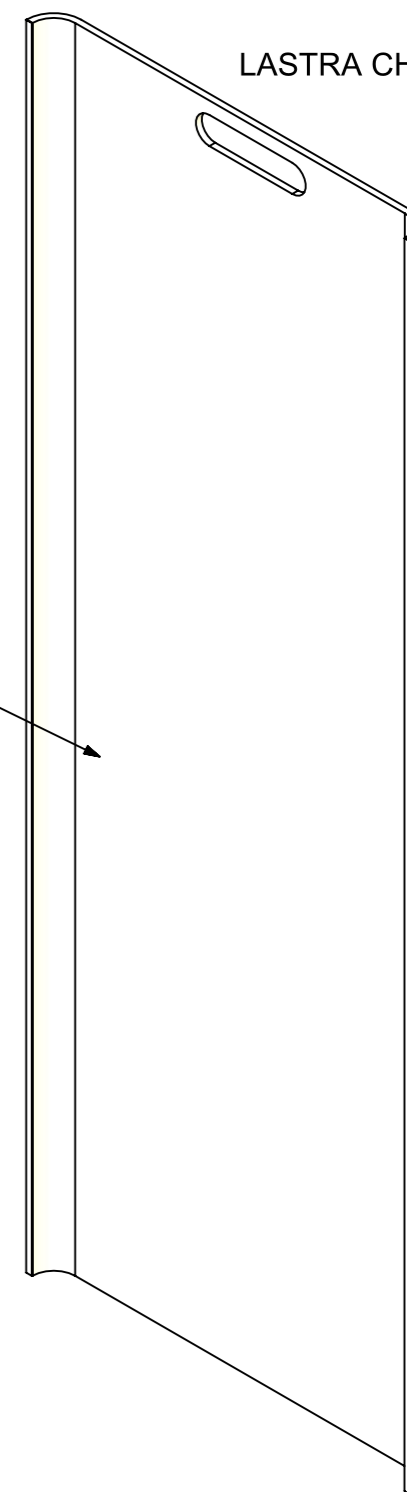

04

VERNICIATURA LASTRA/LACCATI:

● = VERNICIARE 1 LATO + FILI RASATI O BORDATI

NESSUN SIMBOLO = VERNICIARE 2 LATI + FILI RASATI O BORDATI

LOCALE	CODICE	DESCRIZIONE COMPONENTE	FINITURA	GR.
BAGNO OSPITI DX	MD320_MF_ZD01	MOBILE SOTTO LAVELLO		2

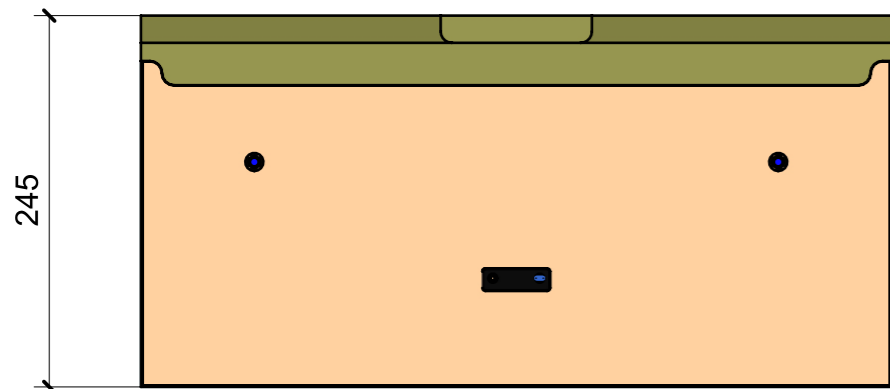
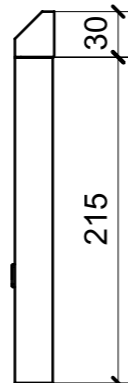

ELEMENTI DA MONTARE
in MF_ZD01
e spedire con unico imballo

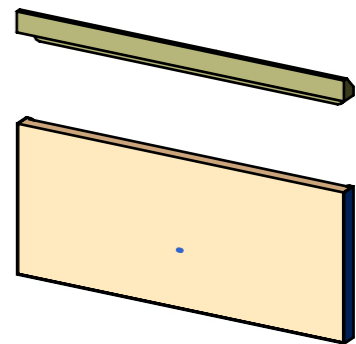
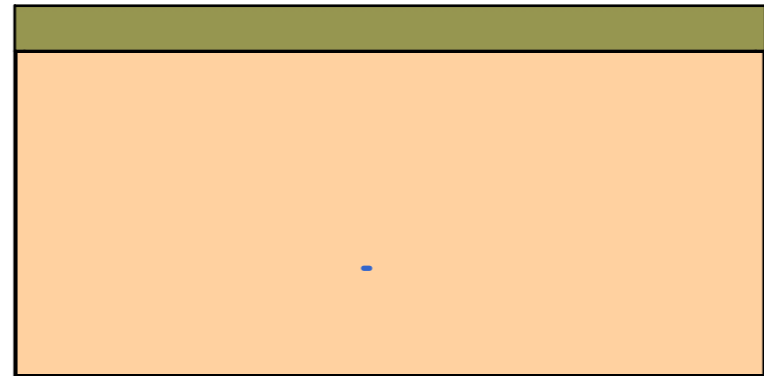

FERRAMENTA	QTY
PLACCHETTA COUNTER STEEL_TECHNOPARTNER_MC-JM49	1
BUSSOLA 6MA X 10 FORO DIAM.8	2

LOCALE	CODICE	DESCRIZIONE COMPONENTE	FINITURA	GR.
BAGNO OSPITI DX	MD320_MF_ZM01	SCATOLA CORPO MISCELATORI		2

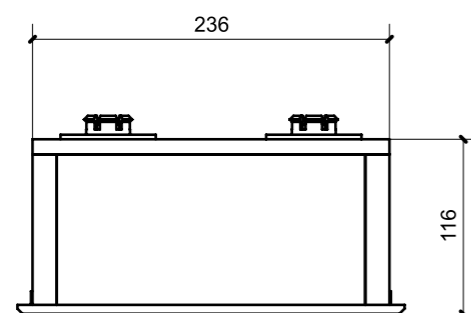
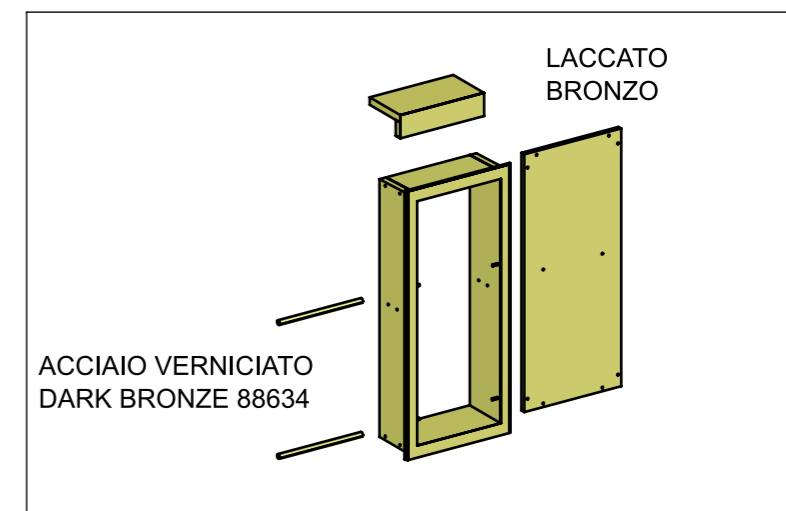
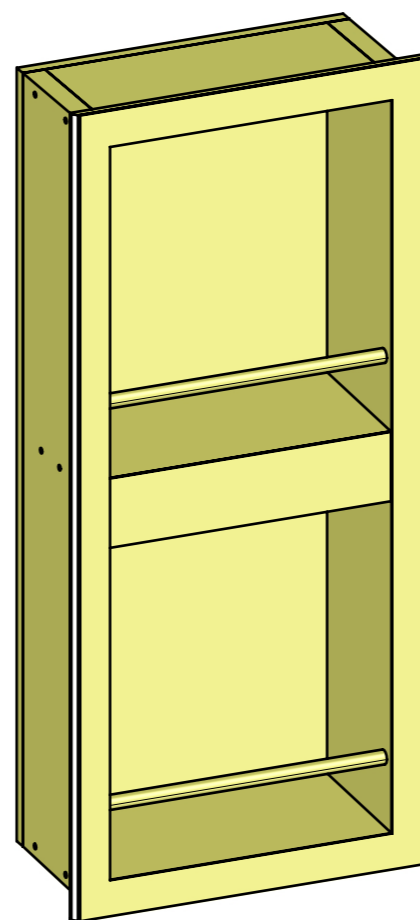
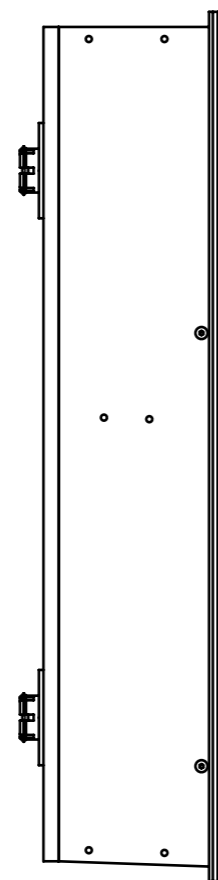
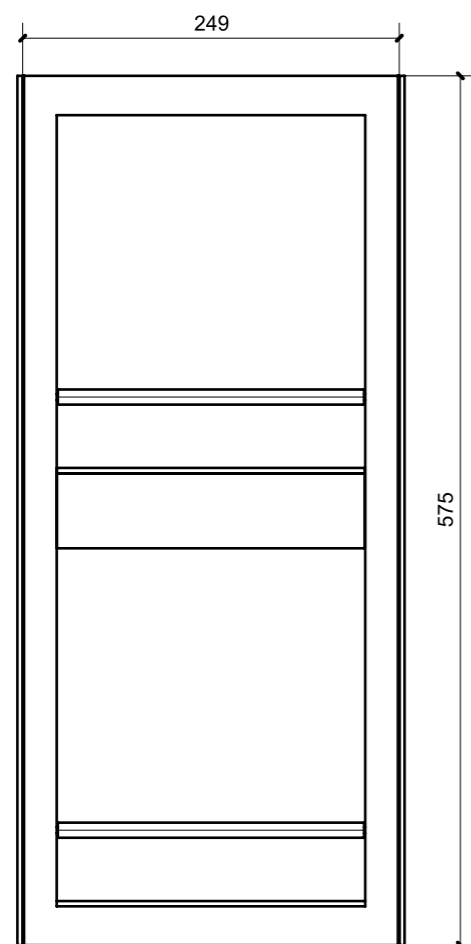

FERRAMENTA	QTY
FITLOCK M_MASCHERPA_3MM_6020202101	4
VITE 4MA X 30 TESTA SVASATA ESAGONALE NERA_FBC_21098	4

LOCALE	CODICE	DESCRIZIONE COMPONENTE	FINITURA	GR.
BAGNO OSPITI DX	MD320_MF_ZN01	SEDUTA DOCCIA		2

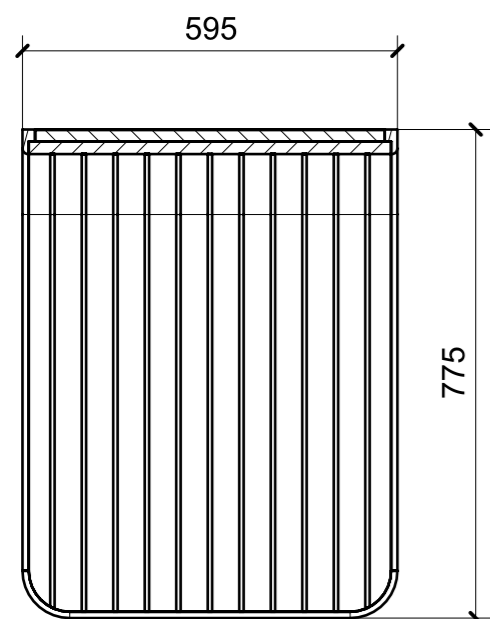
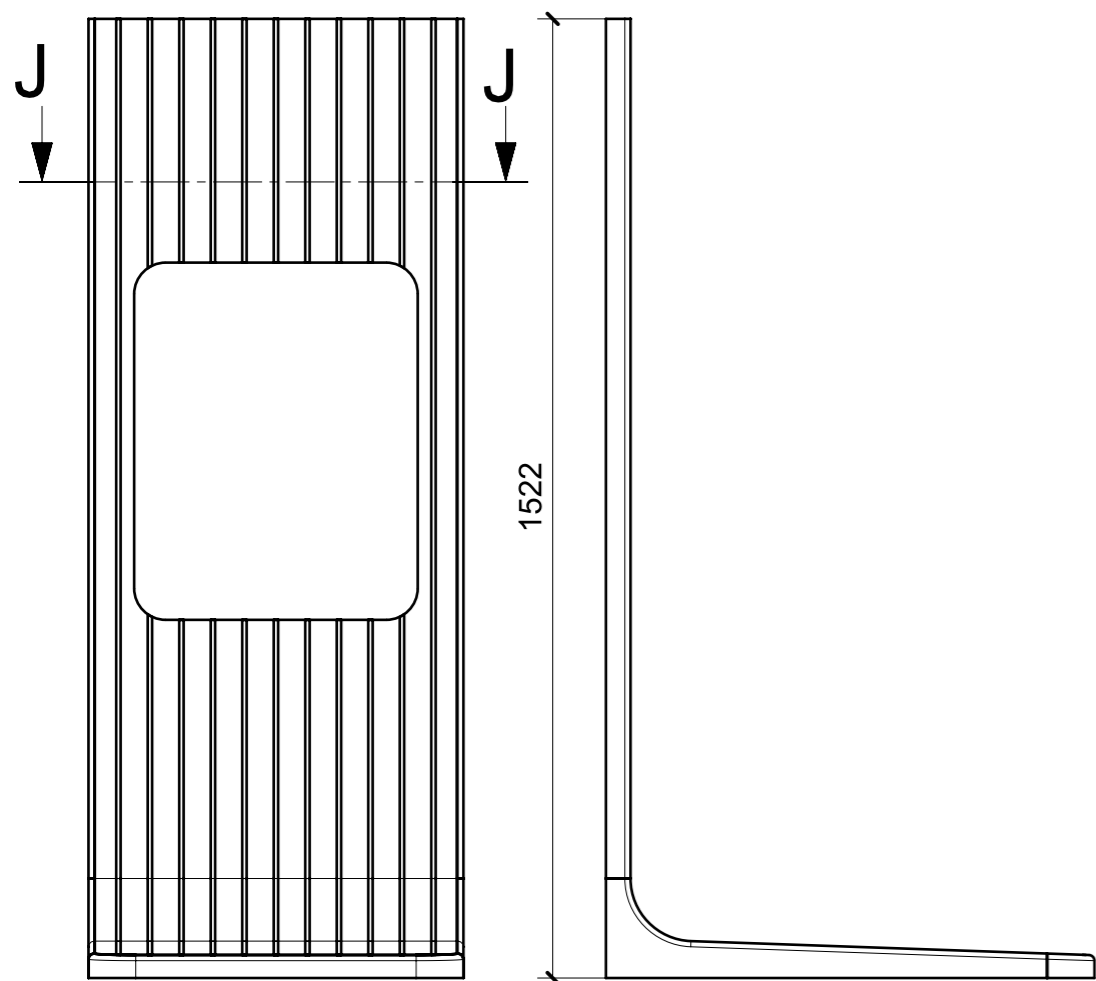

SECTION J-J

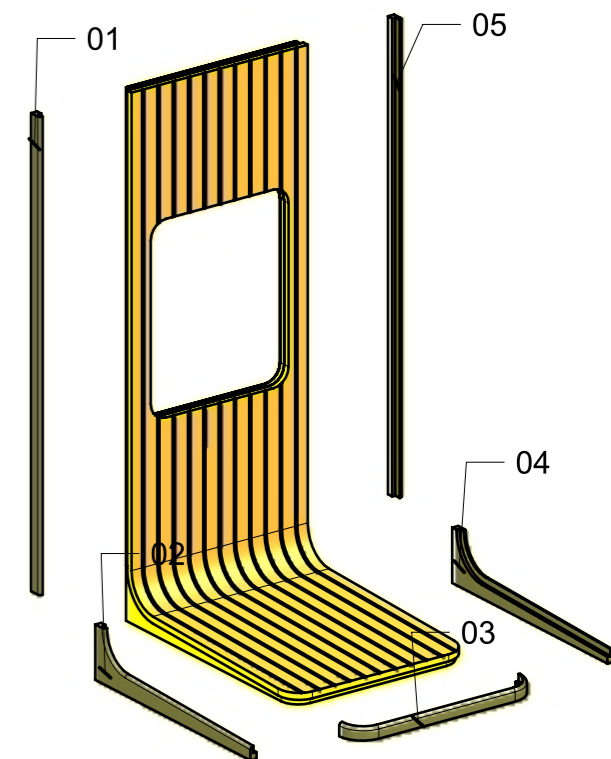
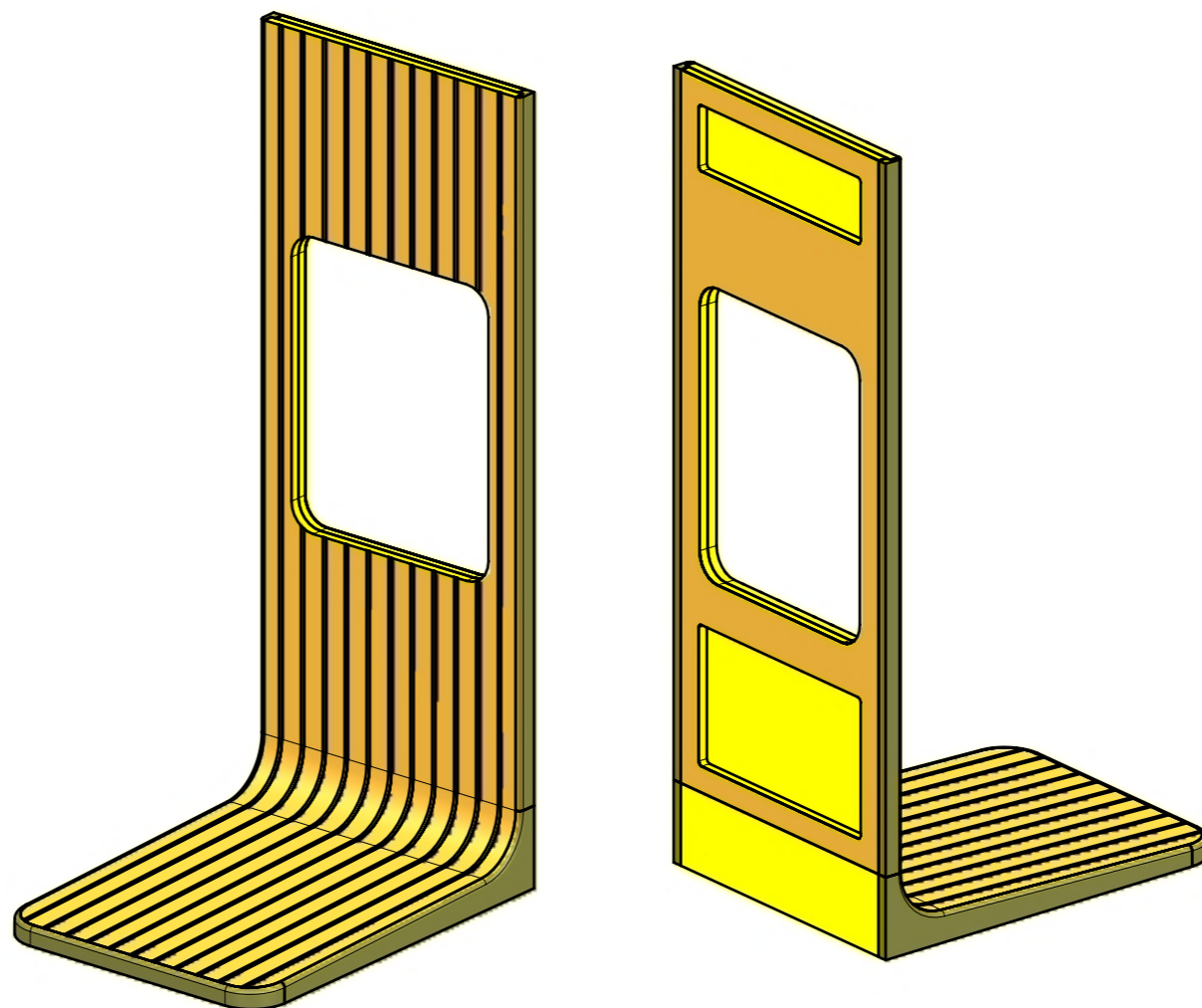

VERNICIATURA LASTRA/LACCATI:

● = VERNICIARE 1 LATO + FILI RASATI O BORDATI

NESSUN SIMBOLO = VERNICIARE 2 LATI + FILI RASATI O BORDATI