

LOCALE	CODICE	DESCRIZIONE COMPONENTE	FINITURA	GR.
BAGNO OSPITI SX	MD320_MF_YB01	PENSILE A MURATA		2

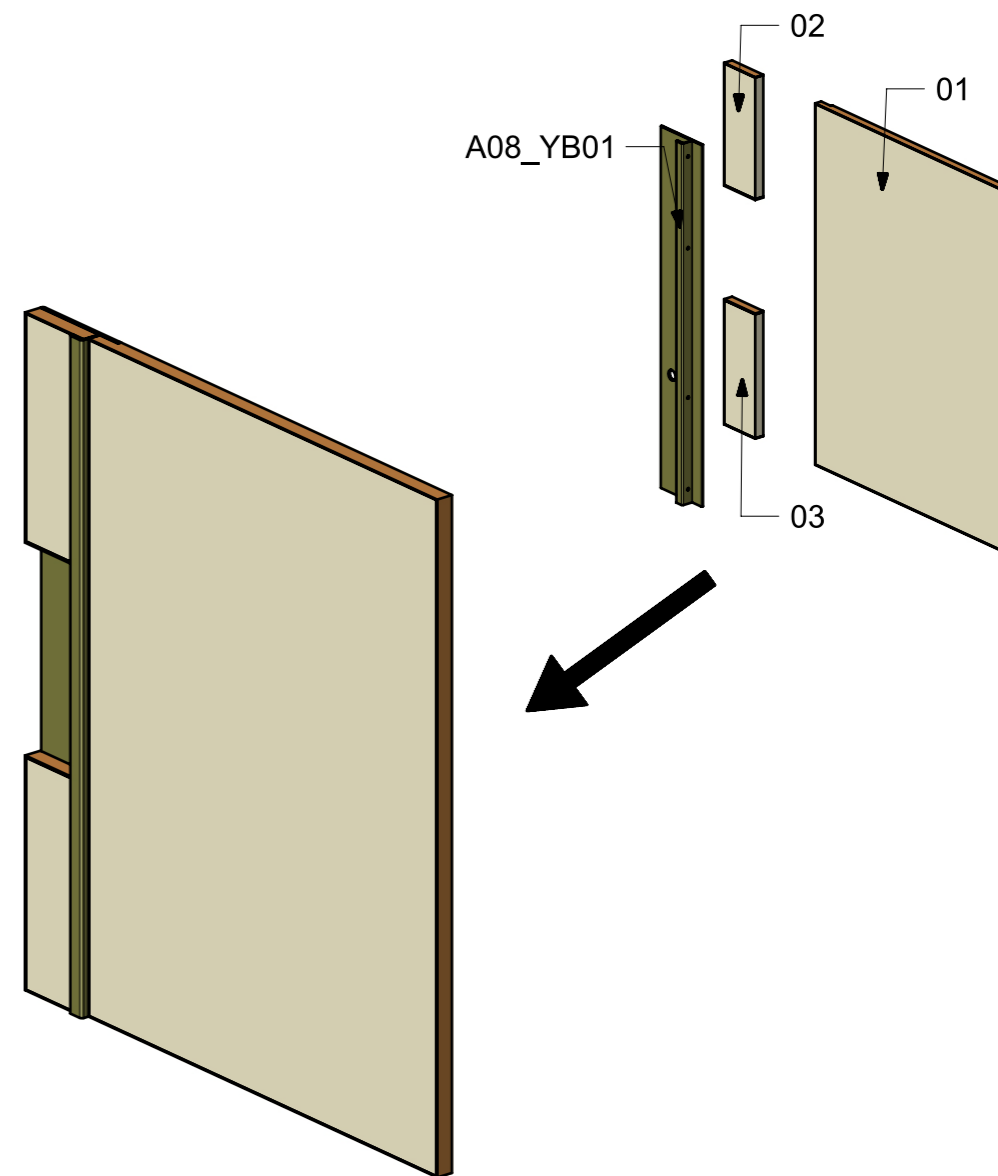
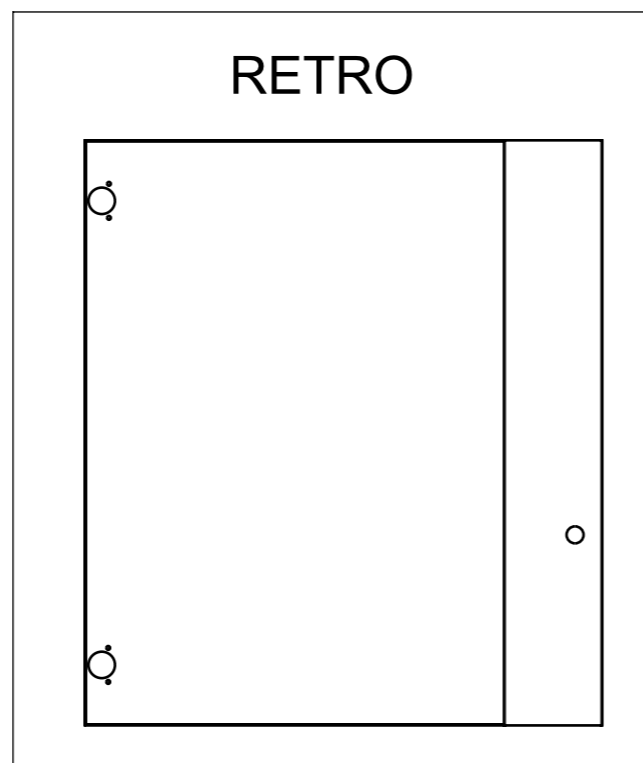
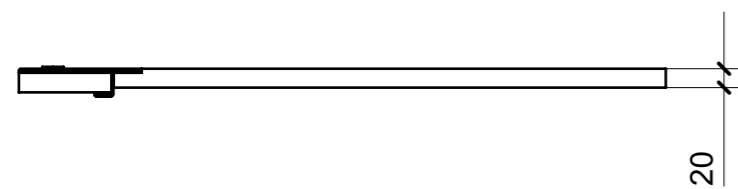
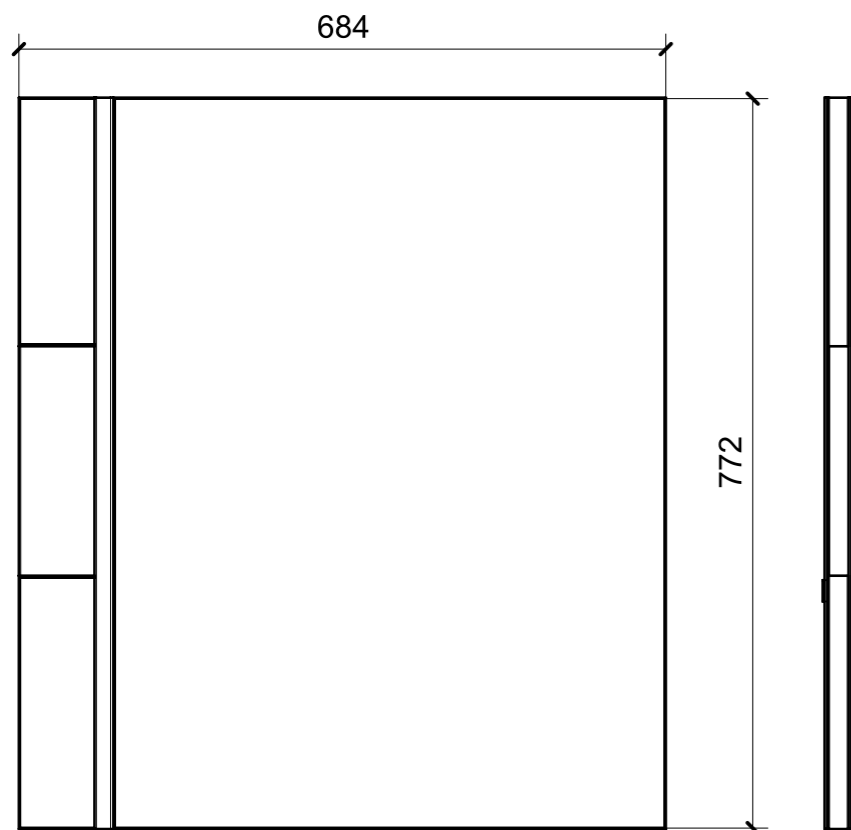

FERRAMENTA	QTY
MAGNETE FORZA MAGNETICA1-5 10KG_HAFELE_246.87.112	1

VERNICIATURA LASTRA/LACCATI:

● = FILI RASATI

● = VERNICIARE 1 LATO + FILI RASATI O BORDATI

NESSUN SIMBOLO = VERNICIARE 2 LATI + FILI RASATI O BORDATI

LOCALE	CODICE	DESCRIZIONE COMPONENTE	FINITURA	GR.
BAGNO OSPITI SX	MD320_MF_YC01	RIVESTIMENTI ZONA LAVELLO		2

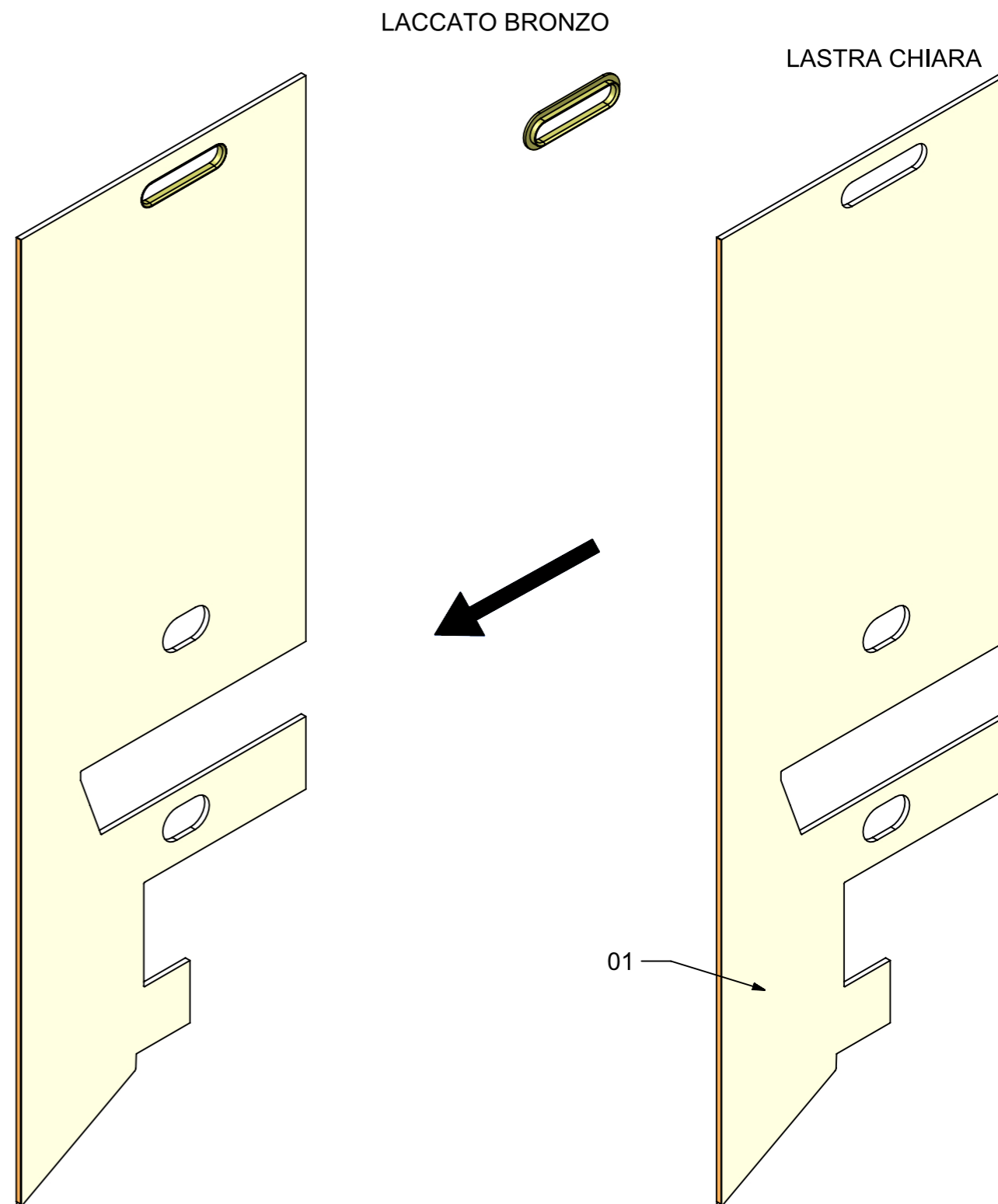
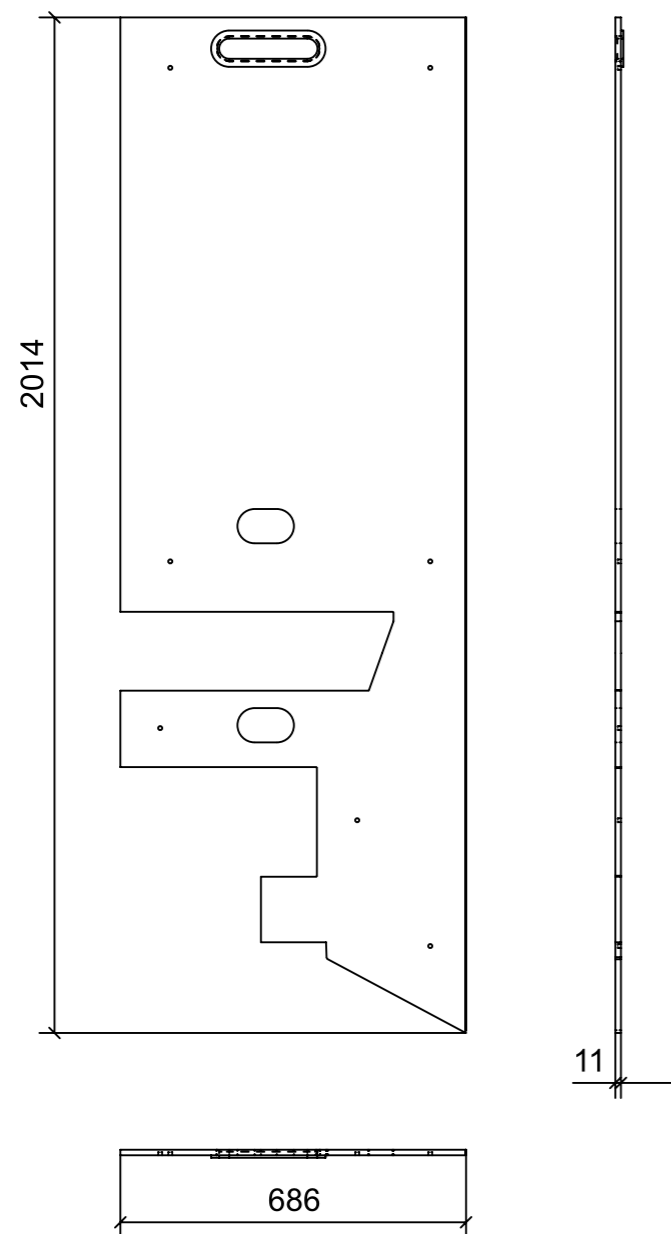

VERNICIATURA LASTRA/LACCATI:

● = VERNICIARE 1 LATO + FILI RASATI O BORDATI

NESSUN SIMBOLO = VERNICIARE 2 LATI + FILI RASATI O BORDATI

LOCALE	CODICE	DESCRIZIONE COMPONENTE	FINITURA	GR.
BAGNO OSPITI SX	MD320_MF_YD01	MOBILE SOTTO LAVELLO		2

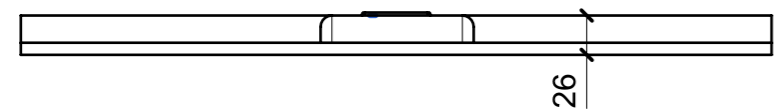
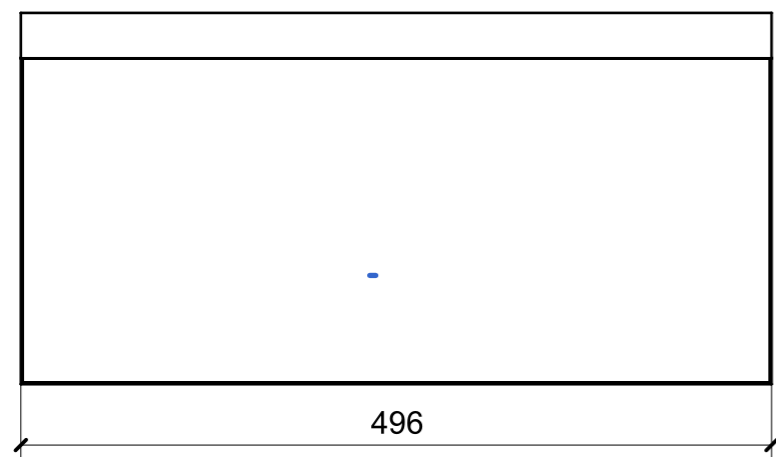

ELEMENTI DA MONTARE  
in MF\_YD01  
e spedire con unico imballo

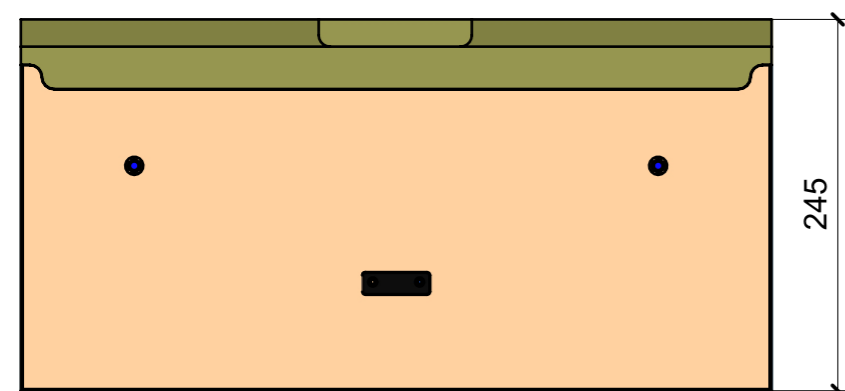
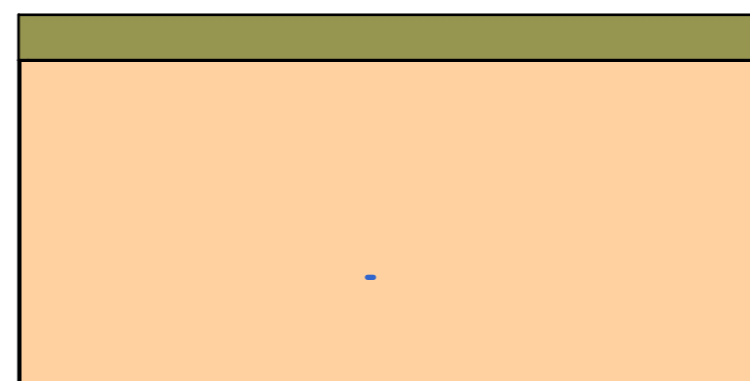
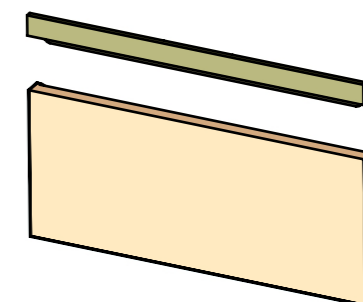

FERRAMENTA	QTY
BUSSOLA 6MA X 10 FORO DIAM.8	2
PLACCHETTA COUNTER STEEL_TECHNOPARTNER_MC-JM49	1

VERNICIATURA LASTRA/LACCATI:

● = FILI RASATI

● = VERNICIARE 1 LATO + FILI RASATI O BORDATI

NESSUN SIMBOLO = VERNICIARE 2 LATI + FILI RASATI O BORDATI

LOCALE	CODICE	DESCRIZIONE COMPONENTE	FINITURA	GR.
BAGNO OSPITI SX	MD320_MF_YM01	SCATOLA CORPO MISCELATORI		2

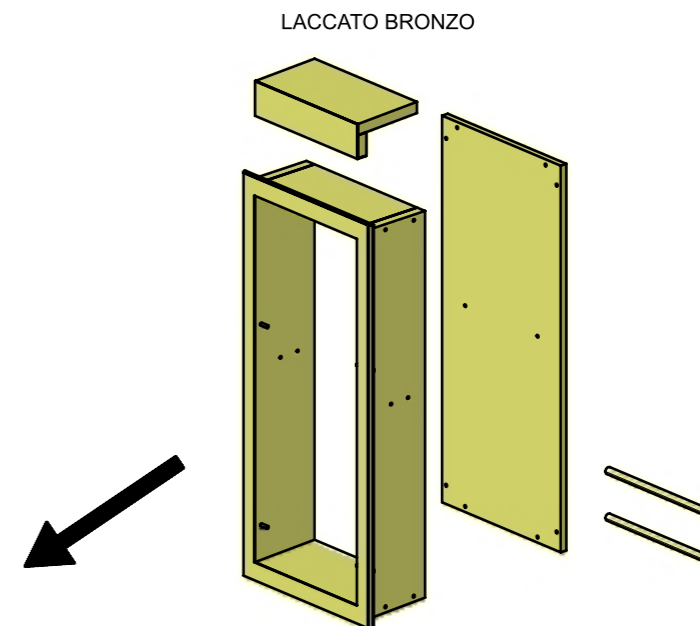
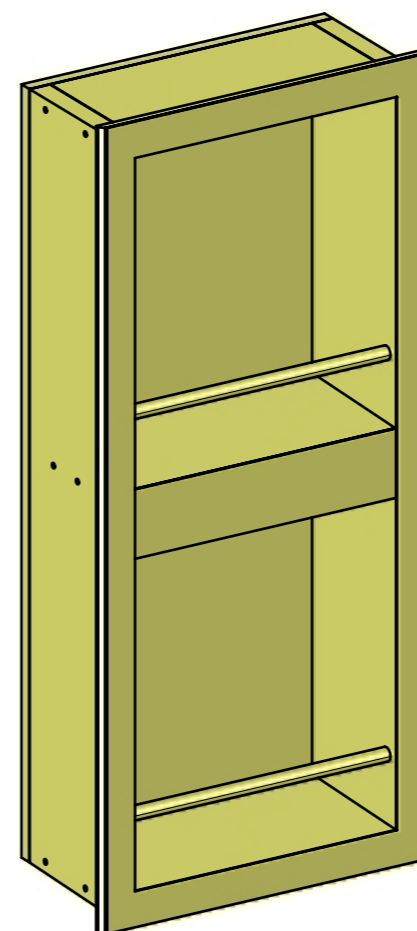
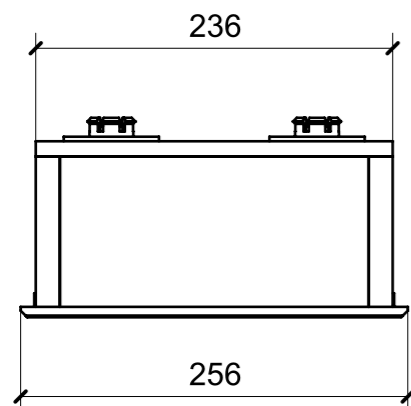
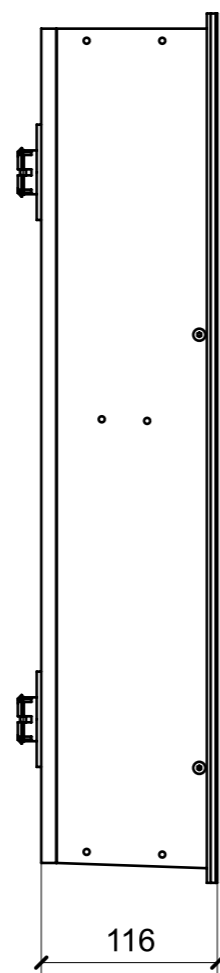
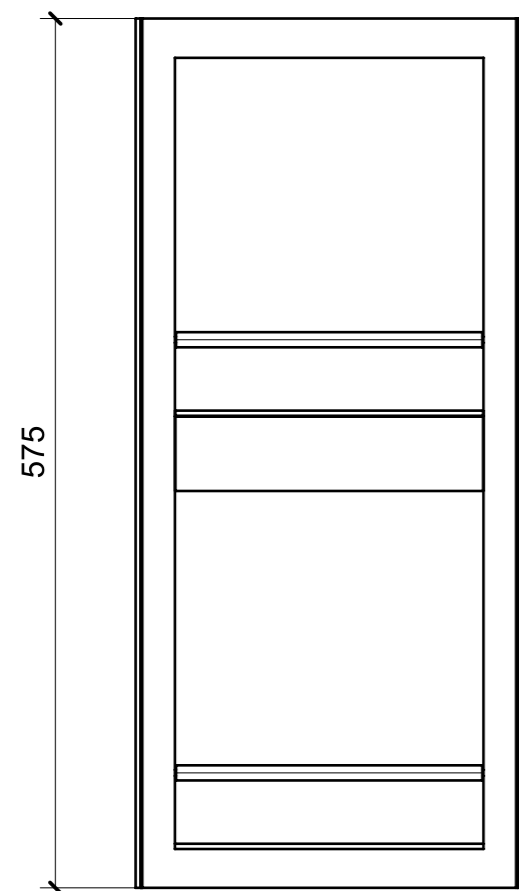

ACCIAIO VERNICIATO  
DARK BRONZE 88634

FERRAMENTA	QTY
VITE 4MA X 30 TESTA SVASATA ESAGONALE NERA_FBC_21098	4
FITLOCK M_MASCHERPA_3MM_6020202101	4

LOCALE	CODICE	DESCRIZIONE COMPONENTE	FINITURA	GR.
BAGNO OSPITI SX	MD320_MF_YN01	SEDUTA DOCCIA		2

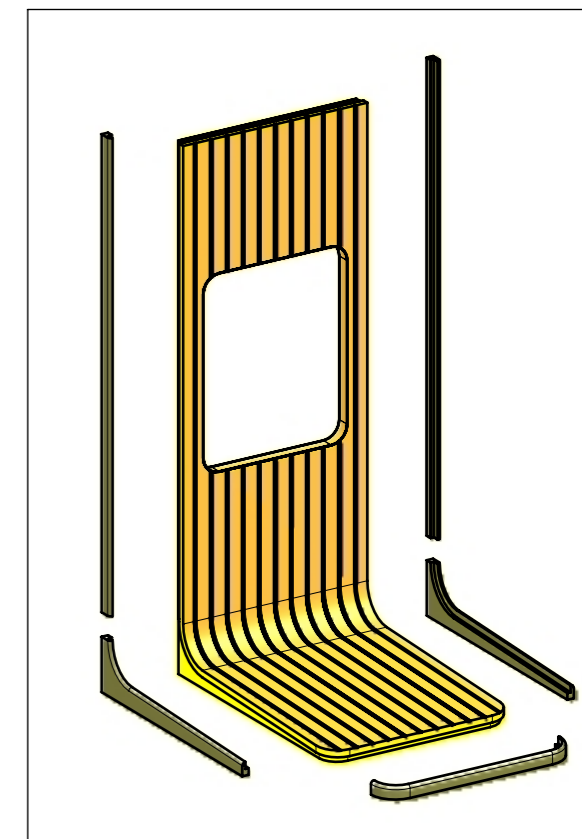
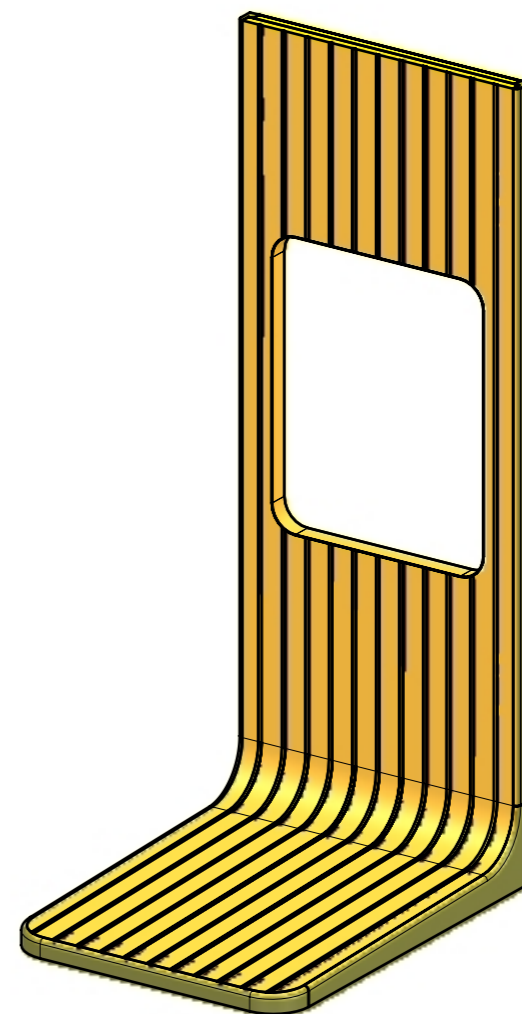
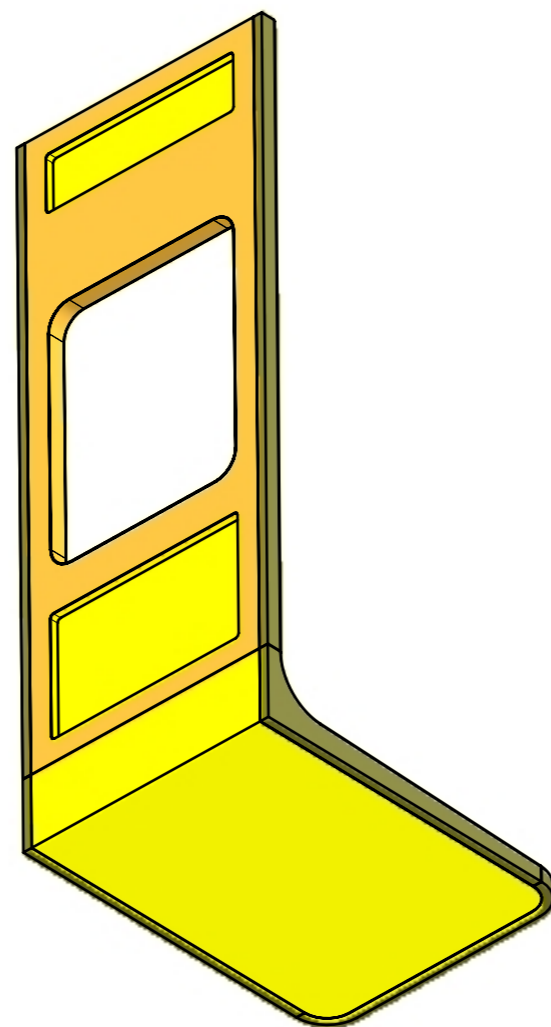
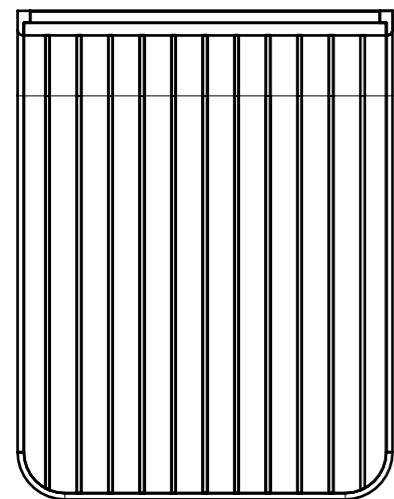
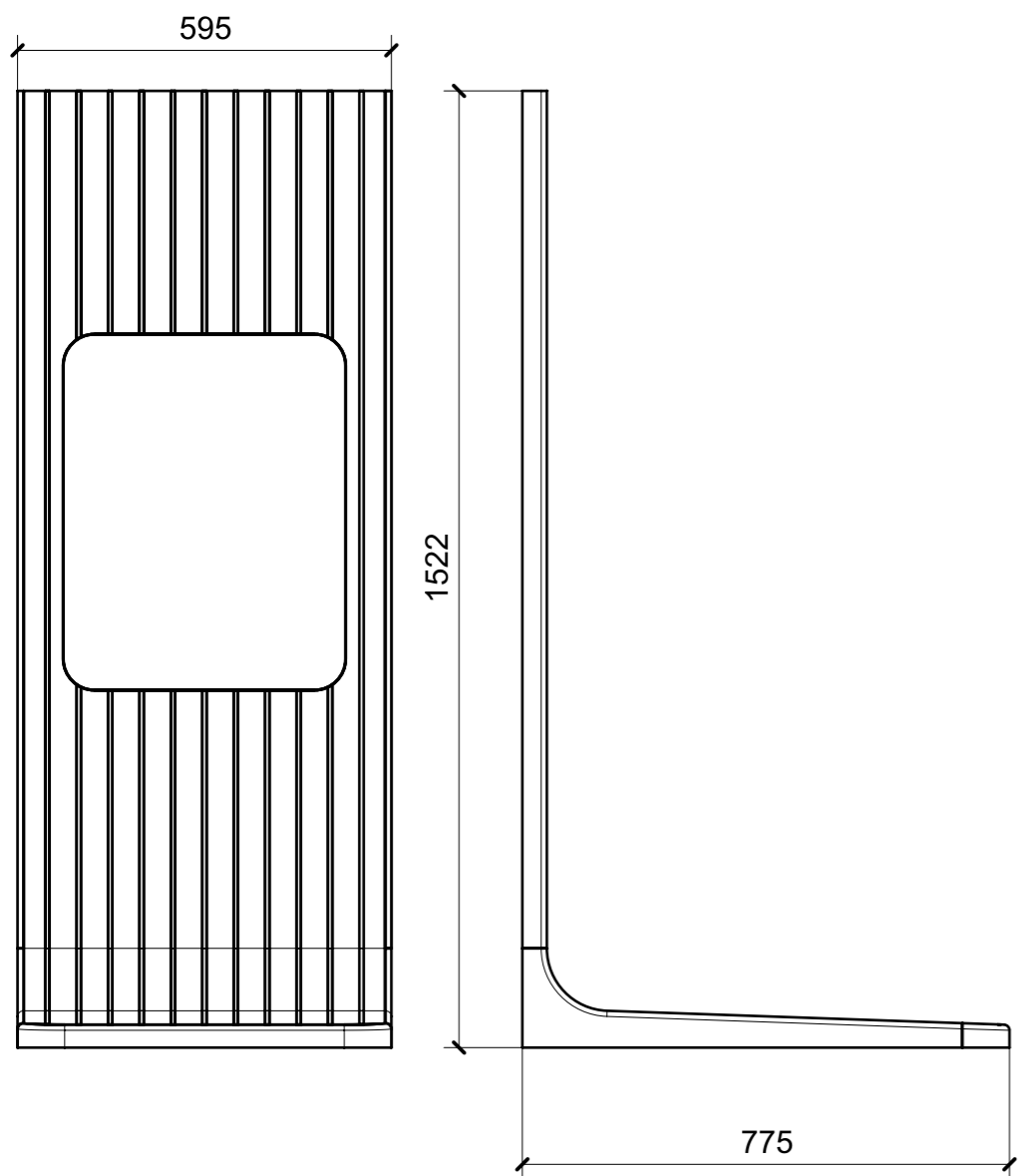

ELEMENTI DA MONTARE  
in MF\_YN01  
e spedire con unico imballo

VERNICIATURA LASTRA/LACCATI:

● = VERNICIARE 1 LATO + FILI RASATI O BORDATI

NESSUN SIMBOLO = VERNICIARE 2 LATI + FILI RASATI O BORDATI