

LOCALE	CODICE	DESCRIZIONE COMPONENTE	FINITURA	GR.
CABINA OSPITI DX	MD320_RA01	STRUTTURA MURATA TESTATA LETTO	OKOUME' GREZZO	2

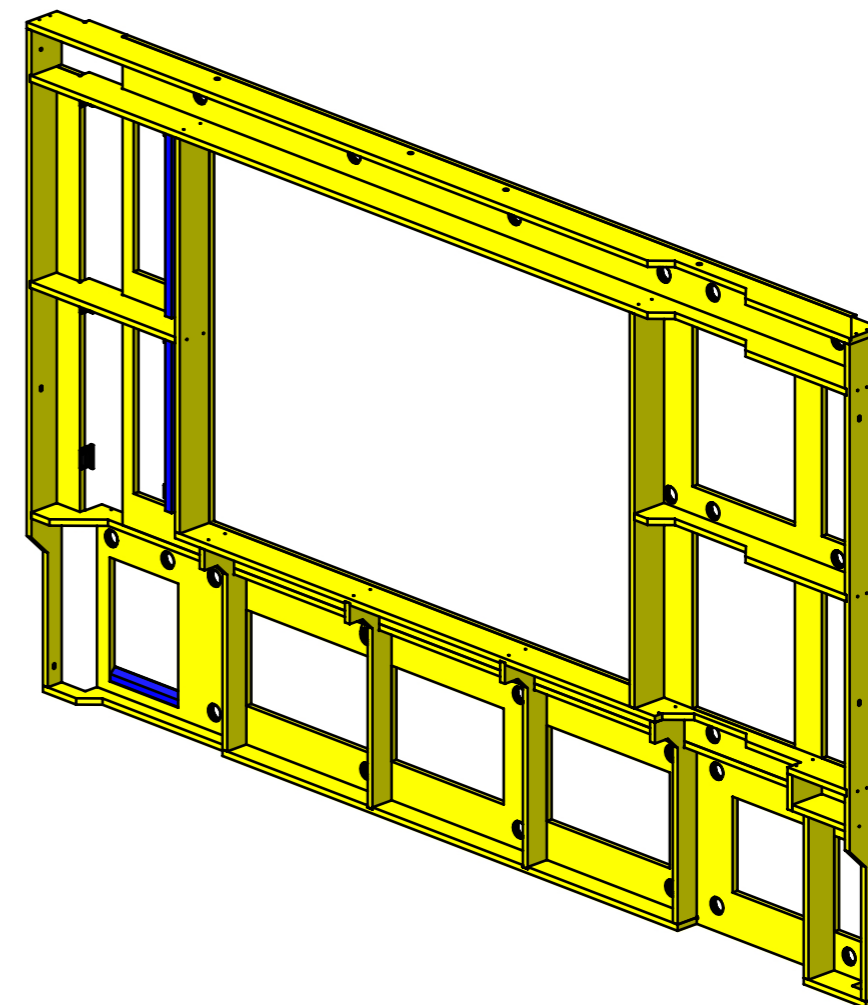

FERRAMENTA	QTY
BUSSOLA 6MA X 10 FORO DIAM.8	4
CHIUSURA A SPINTA_TECHNOPARTNER_SOU C3-203	6
FITLOCK F_MASCHERPA_6020101102	30

LOCALE	CODICE	DESCRIZIONE COMPONENTE	FINITURA	GR.
CABINA OSPITI DX	MD320_RB01	COMODINO PRUA	LAMINATO SMART 0180-2 JUNGLE	2

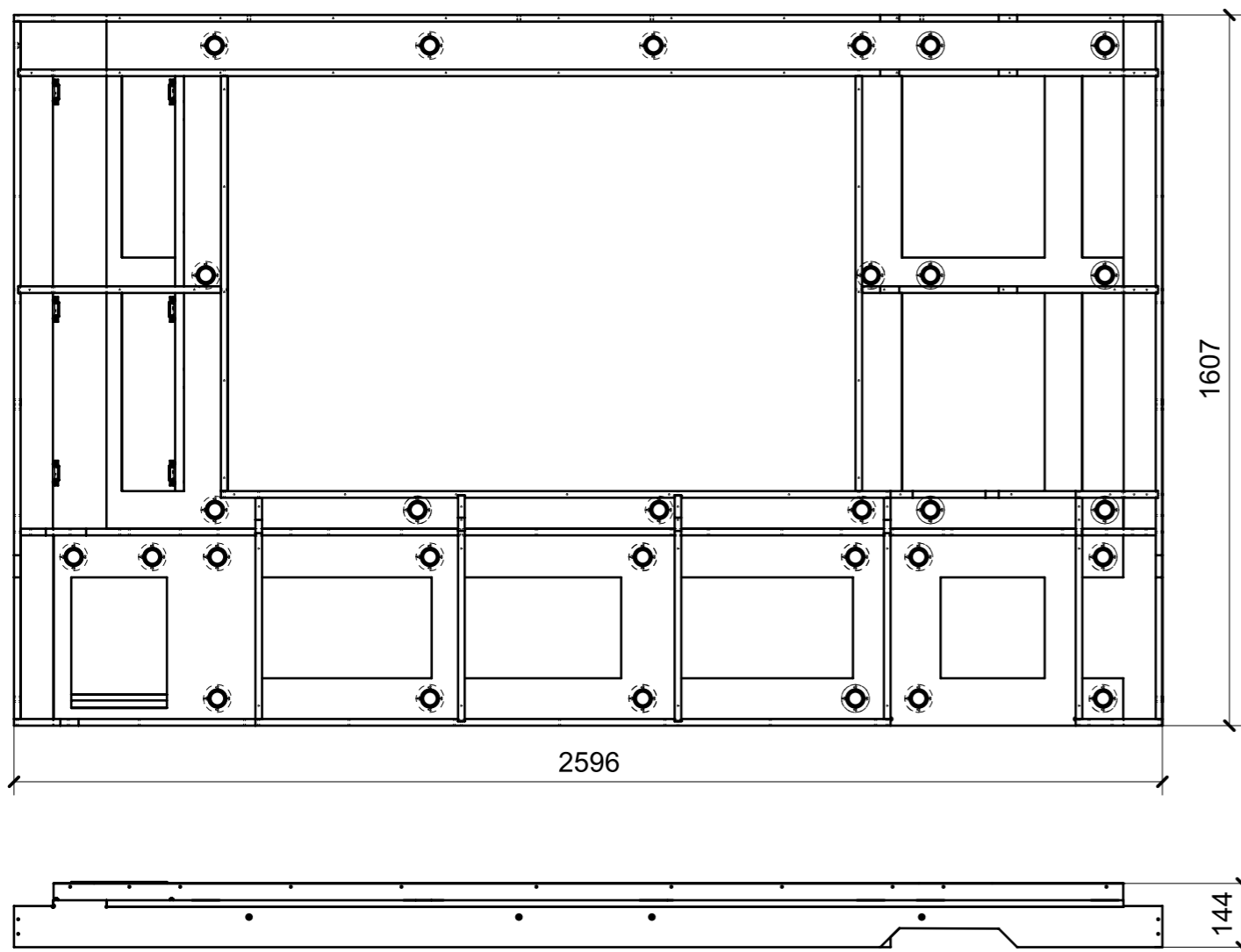
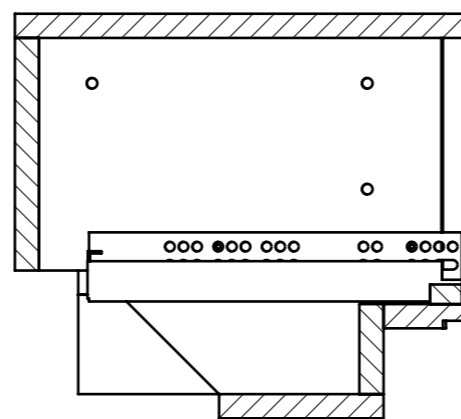
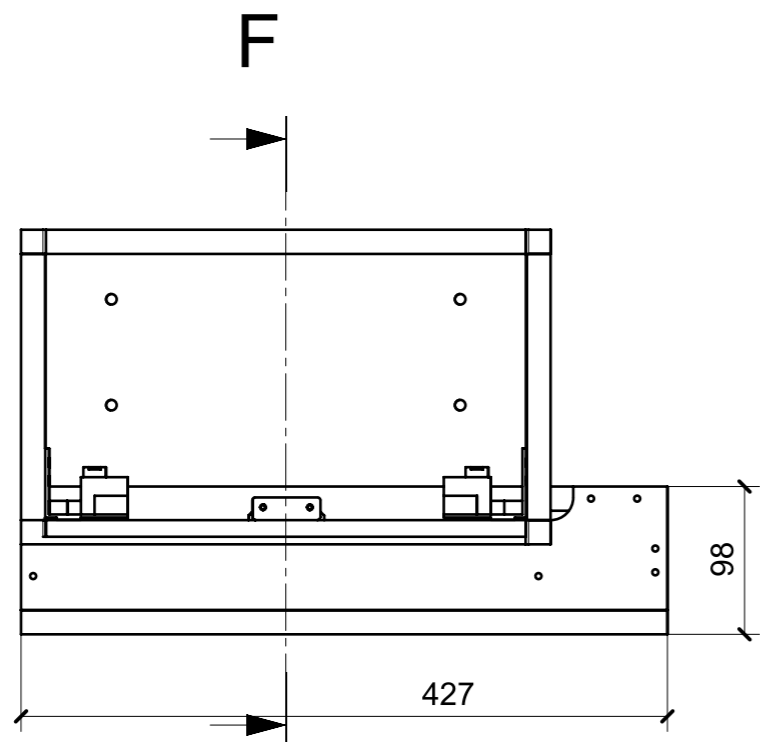

SECTION F-F

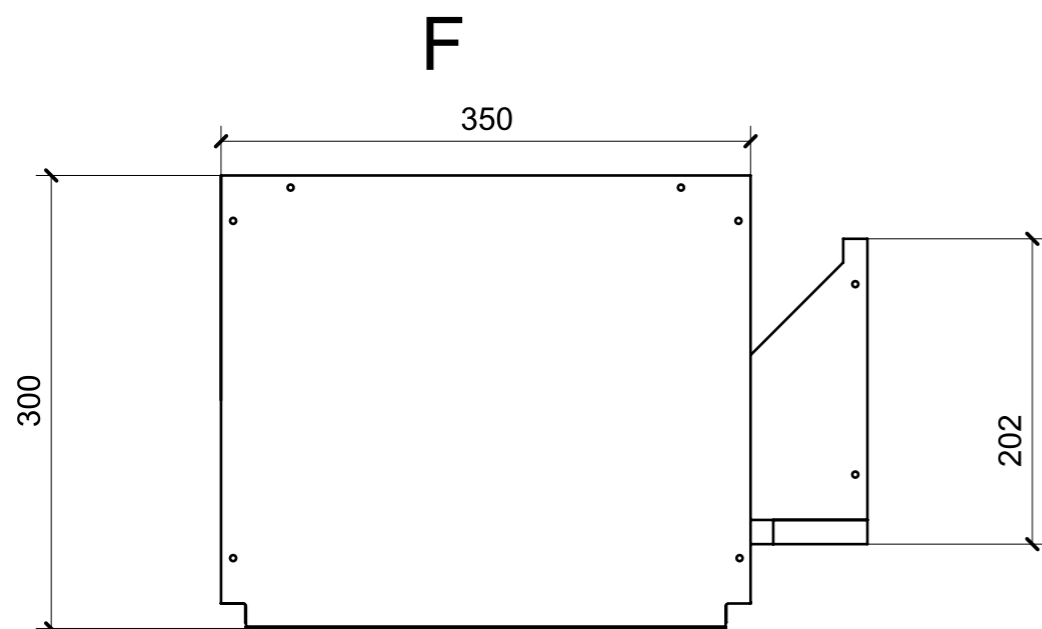
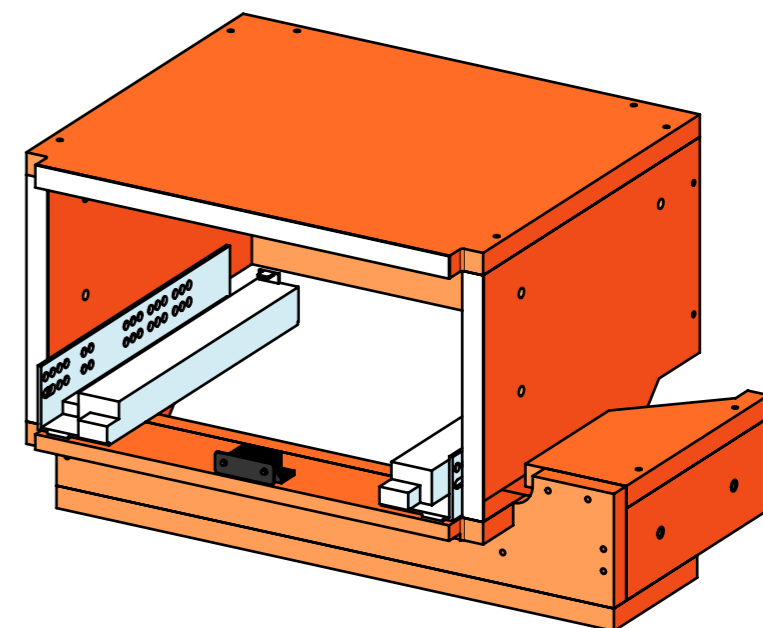

FERRAMENTA	QTY
MD320_GR2_L01_RB01_07	1
GUIDA DYNAPRO SOFTCLOSE L250 R_FBC_F130107790 4D	1
GUIDA DYNAPRO SOFTCLOSE L250 L_FBC_F130107790 4D	1
CALAMITA SEALED MAGNETIC_TECNOPARTNER_MC-JM50-BL	1
PLACCHETTA COUNTER STEEL_TECNOPARTNER_MC-JM49	1
BUSSOLA 6MA X 10 FORO DIAM.8	2

LOCALE	CODICE	DESCRIZIONE COMPONENTE	FINITURA	GR.
CABINA OSPITI DX	MD320_RC01	STRUTTURA LETTO VAR.1	LAMINATO SMART 0180-2 JUNGLE-LACCATO BIANCO GOFFRATONE	2

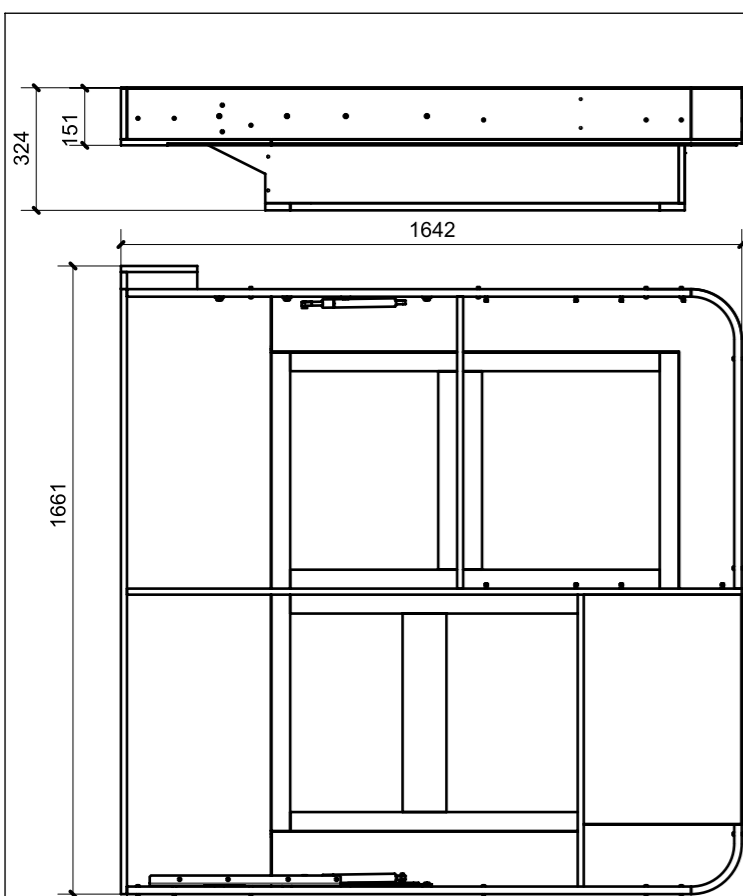

01

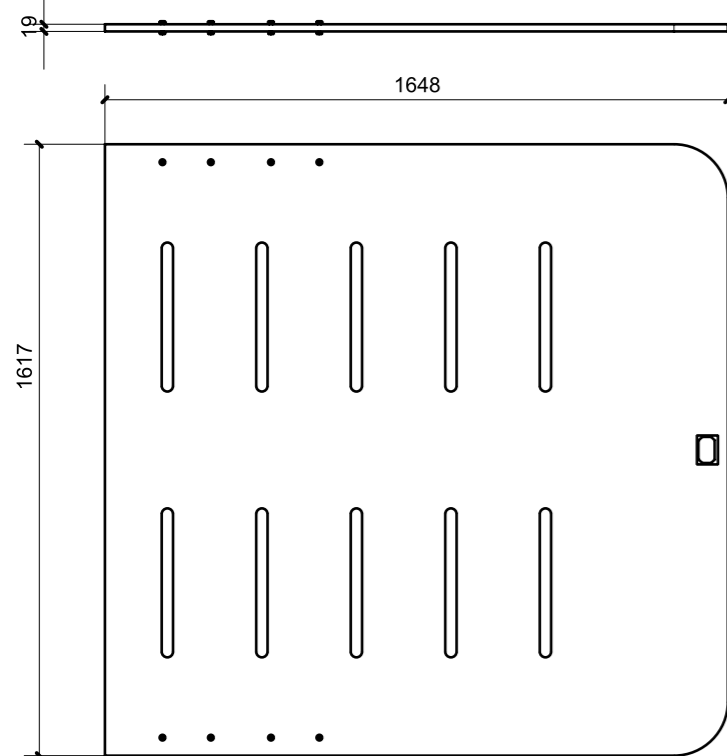

03

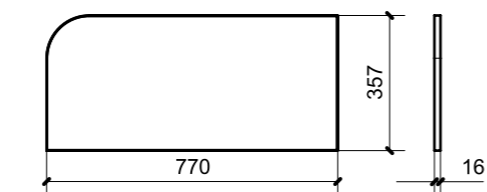

02

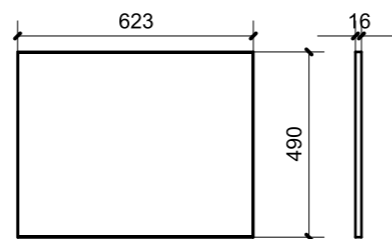

05

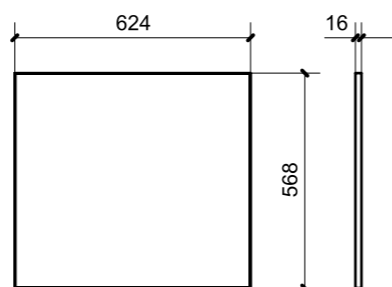

06

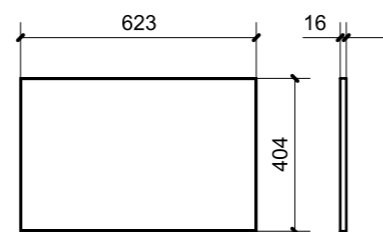

07

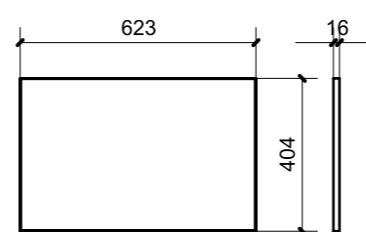

08

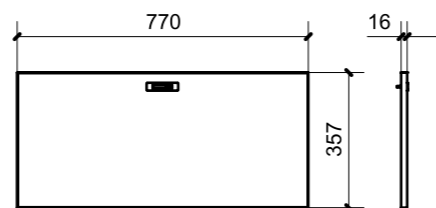

09

01/02/03/05/06/07/08/09
ELEMENTI DA MONTARE
in MG_RC01
e spedire con unico imballo

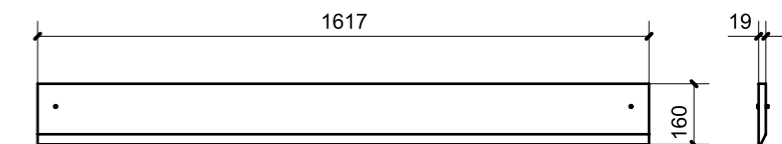
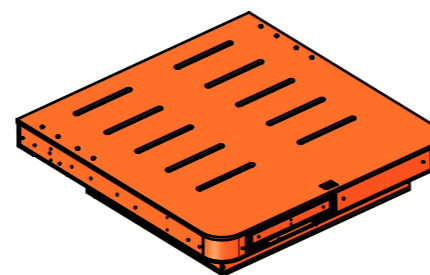

04

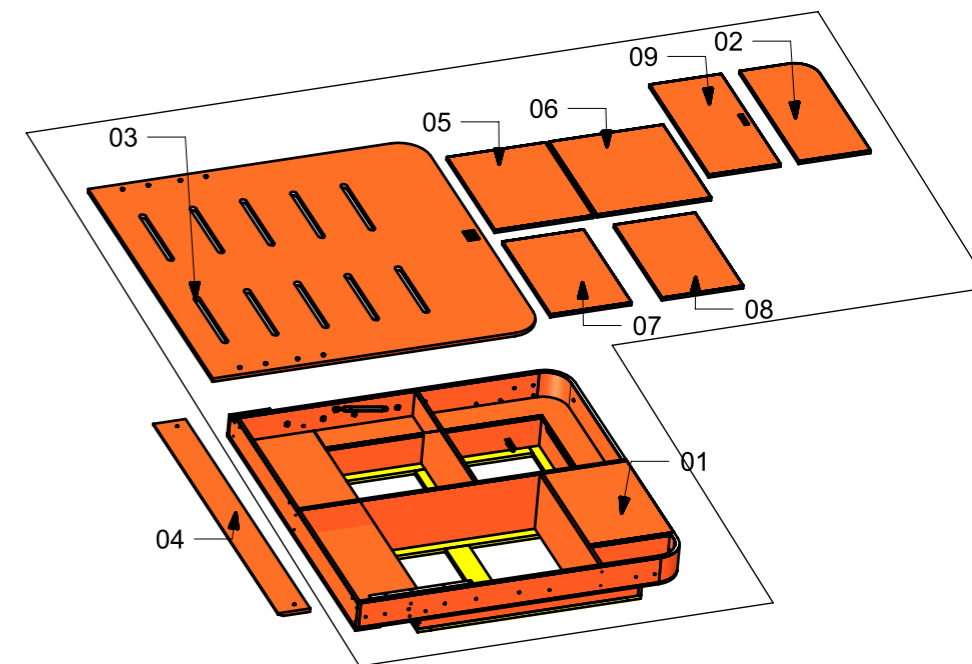

FERRAMENTA	QTY
ALZAPAGLIOLI_FORESTI_164.B BRUNITON	2
VITE 4MA X 12 TESTA SVASATA ESAGONALE NERA_FBC	4
REGGIRIPIANO PERNO RAPIDO X CR. CO-RING_FBC BORGHI_00073653	8
GUIDA DYNAPRO SOFTCLOSE L400 L_FBC_F130107808 4D	1
GUIDA DYNAPRO ADJUSTAMENT ADAPTER L_FBC_F134141746 4D	1
GUIDA DYNAPRO FRONT LOCKING DEVICE L_FBC_F134108955 4D	1
GUIDA DYNAPRO SOFTCLOSE L400 R_FBC_F130107808 4D	1
GUIDA DYNAPRO ADJUSTAMENT ADAPTER R_FBC_F134141746 4D	1
GUIDA DYNAPRO FRONT LOCKING DEVICE R_FBC_F134108955 4D	1
CP TRAPEZI STABILUS TZ 530 BTZ T2.A0_FBC_99999032	1
PLACCHETTA COUNTER STEEL_TECHNOPARTNER_MC-JM49	2
CALAMITA SEALED MAGNETIC_TECNOPARTNER_MC-JM50-BL	2
BUSSOLA RAPIDA_FBC BORGHI_00280877	8
SEEGER PER MECC. LETTO_00407908	2
PISTONE A GAS STABILUS_456306_600NW-L385_FBC_99999049	2
RANELLA SP.2 MM DIAM.24 FORO 8_FBC	8
BUSSOLA 8MA X 14_FBC	8
TBL 8MA X 20_FBC	8
BUSSOLA 6MA X 10 FORO DIAM.8	2
VITE 6MA X 30 TESTA BOMBATA NERA BHCS	15

LOCALE	CODICE	DESCRIZIONE COMPONENTE	FINITURA	GR.
CABINA OSPITI DX	MD320_RRC01	LETTI SCORREVOLI VAR.2	LAMINATO SMART 0180-2 JUNGLE/MDF	2

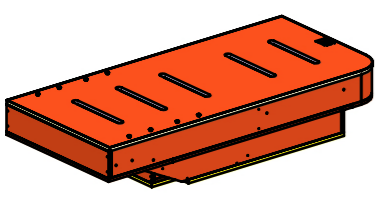
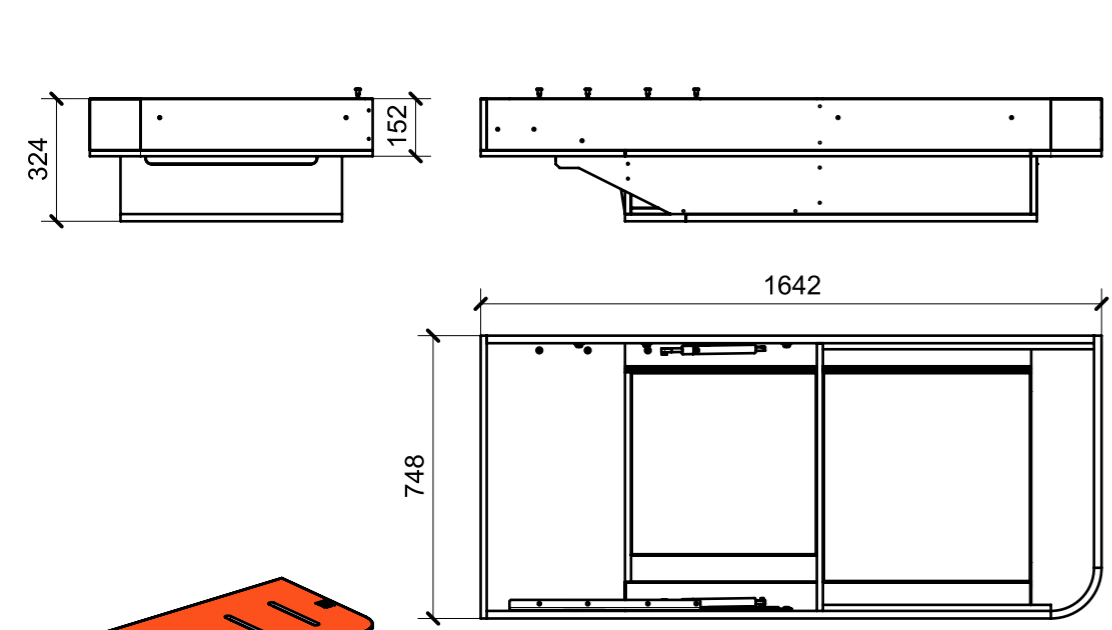

01
ELEMENTI DA MONTARE
in MG_RRC01
e spedire con unico imballo

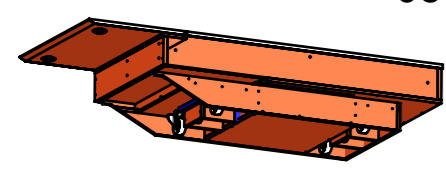
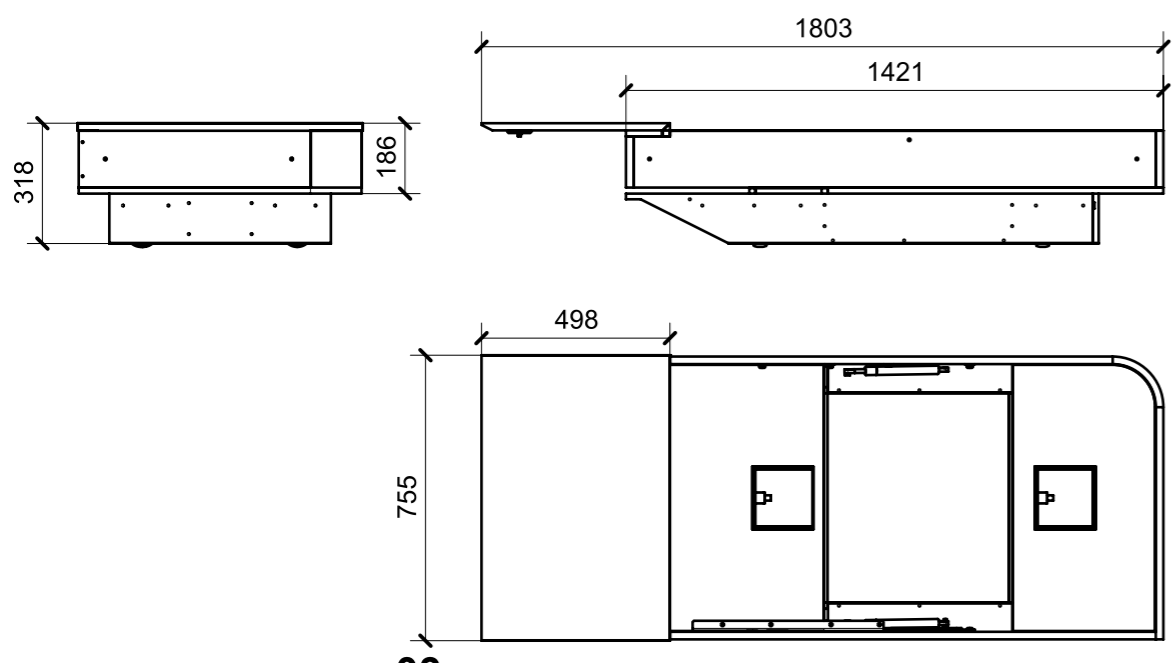
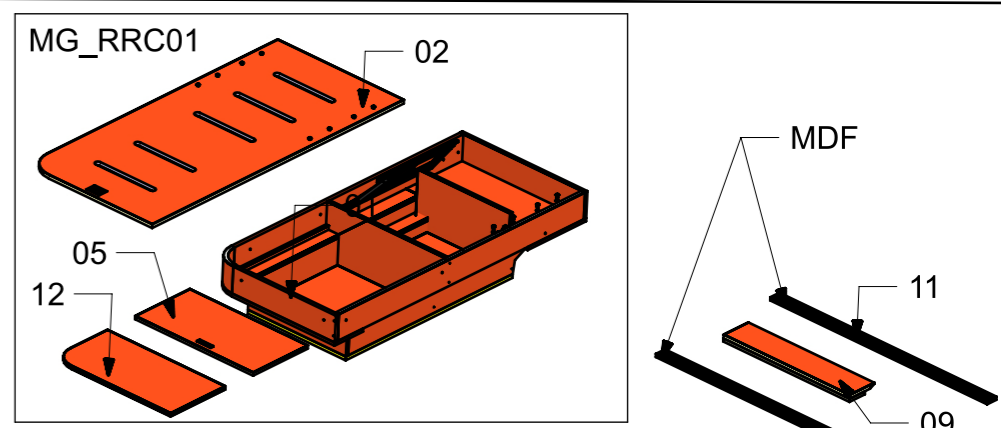
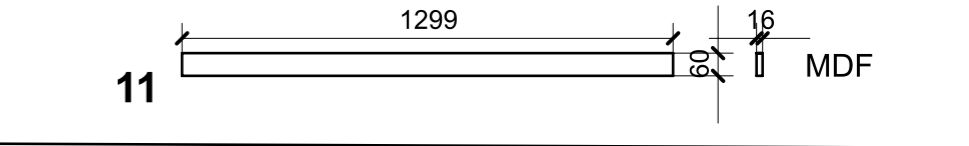
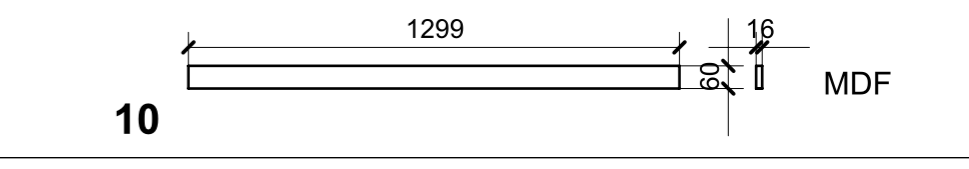
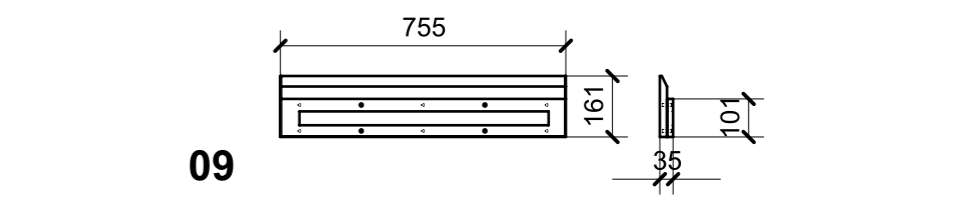
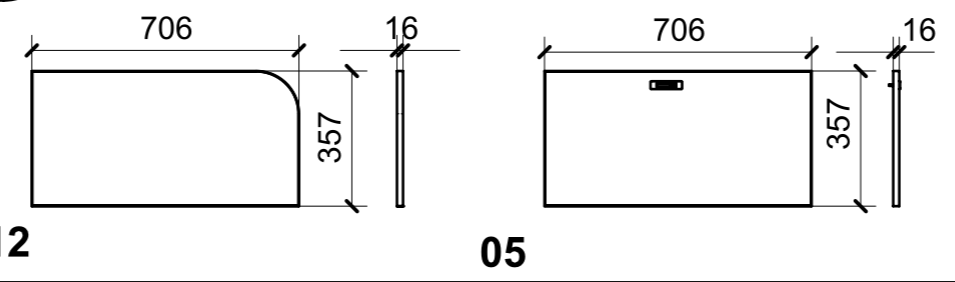

ELEMENTI DA MONTARE
in MG_RRC02
e spedire con unico imballo

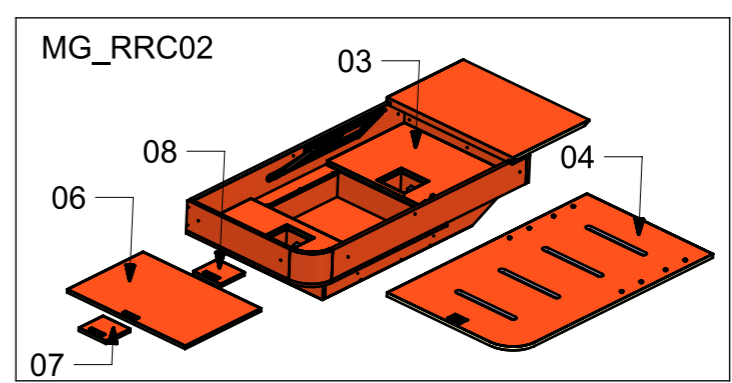
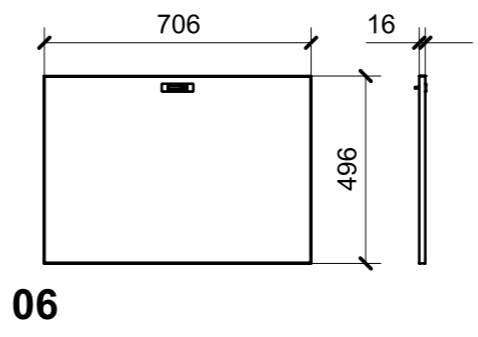
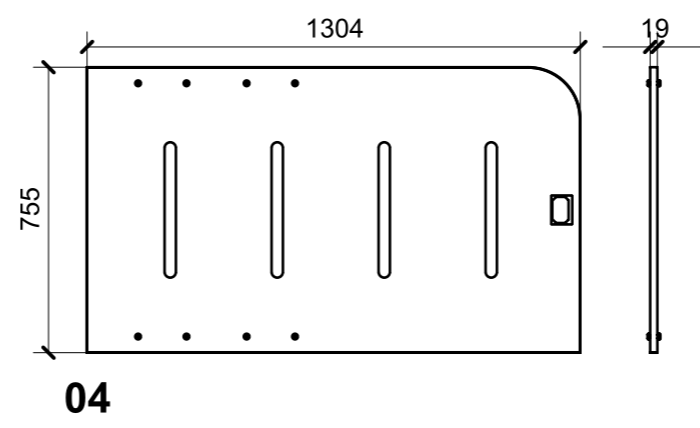
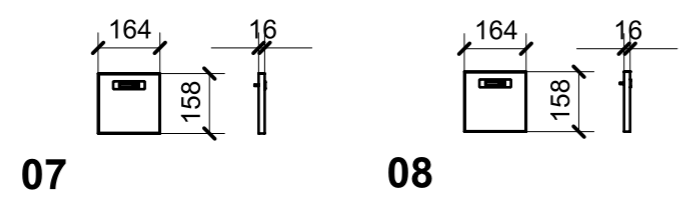

FERRAMENTA	QTY
MANIGLIETTA ALZA LETTO_FORESTI_ART.76A.C	2
BORCHIA PASSO 6MA_FBC	20
TBL 6MAX15_FBC	20
CP TRAPEZI NERI STABILUS TZ 530 BTZ T2.A0_FBC_99999049	2
PISTONE A GAS STABILUS_456306_600NW-L385_FBC	2
TBL 8MA X 20_FBC	16
BUSSOLA 8MA X 14_FBC	16
RANELLA SP.2 MM DIAM.24 FORO 8_FBC	16
PISTONE A GAS STABILUS_456306_600NW-L385_FBC_99999049	2
SEEGER PER MECC. LETTO_00407908	4
BUSSOLA 6MA X 10 FORO DIAM.8	3
RUOTA GRANDE Z141-80_FBC BORGHI_00307505	4
FERMAPORTA DORMAKABA_HAFELE_938_00_001	2
RUOTA PICCOLA HF 66104340_FBC BORGHI_00398510	2
VITE 6MA X 25 TESTA BOMBATA NERA BHCS 10.9 ISO 7380	3
ALZAPAGLIOLI_FORESTI_164.B BRUNITON	4
VITE 4MA X 12 TESTA SVASATA ESAGONALE NERA_FBC	8

LOCALE	CODICE	DESCRIZIONE COMPONENTE	FINITURA	GR.
CABINA OSPITI DX	MD320_RD01	COMODINO POPPA VAR.1	LAMINATO SMART 0180-2 JUNGLE	2

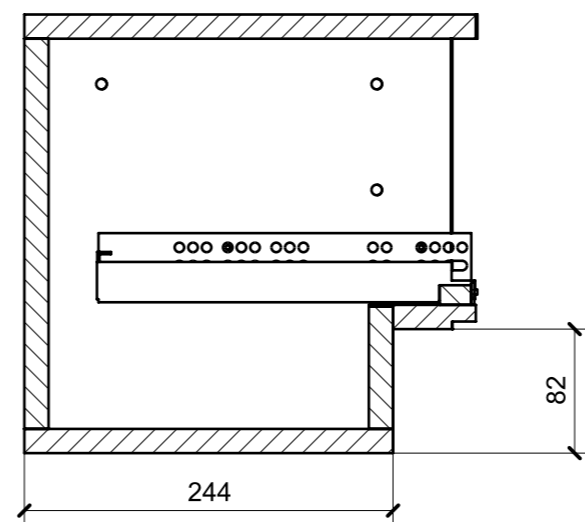
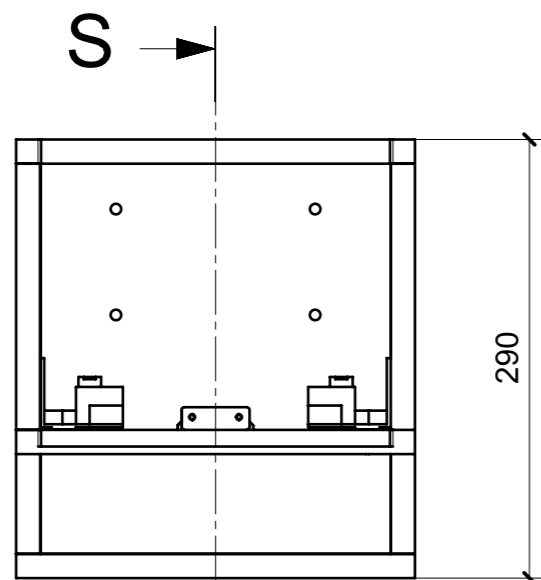

SECTION S-S

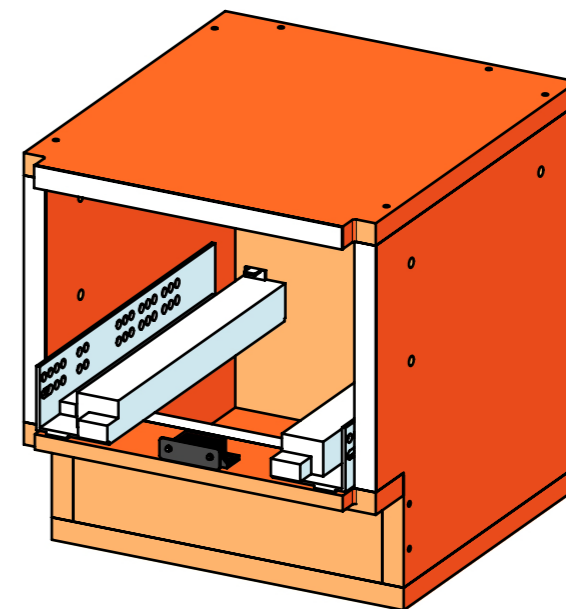
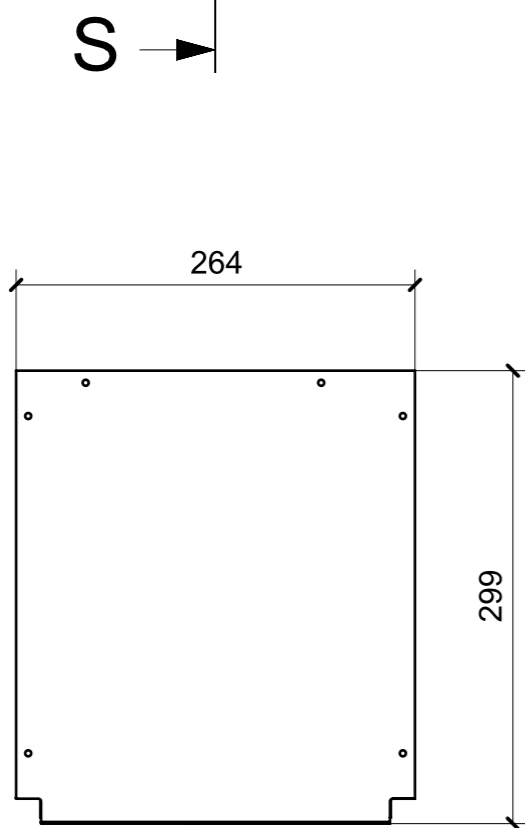

FERRAMENTA	QTY
GUIDA DYNAPRO SOFTCLOSE L250 L_FBC_F130107790 4D	1
GUIDA DYNAPRO SOFTCLOSE L250 R_FBC_F130107790 4D	1
CALAMITA SEALED MAGNETIC_TECNOPARTNER_MC-JM50-BL	1
PLACCHETTA COUNTER STEEL_TECNOPARTNER_MC-JM49	1

LOCALE	CODICE	DESCRIZIONE COMPONENTE	FINITURA	GR.
CAB. OSPITI DX	MD320_RRD01	COMODINO POPPA VAR.2	LAMINATO SMART 0180-2 JUNGLE	2

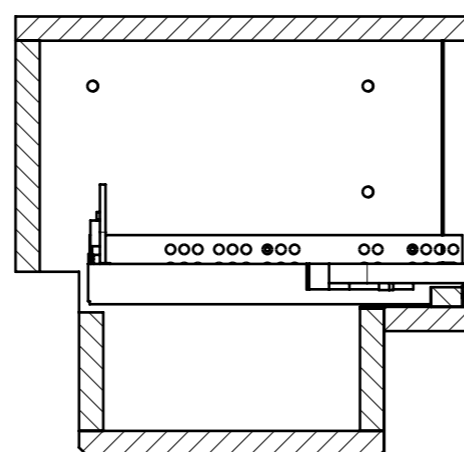
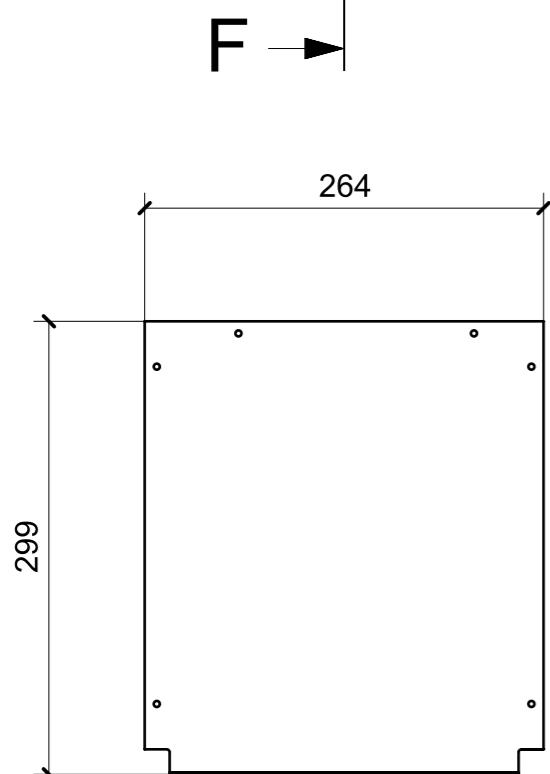
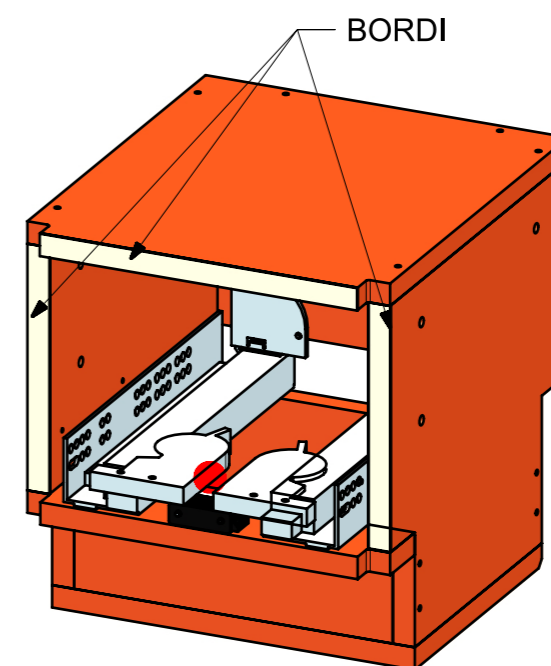
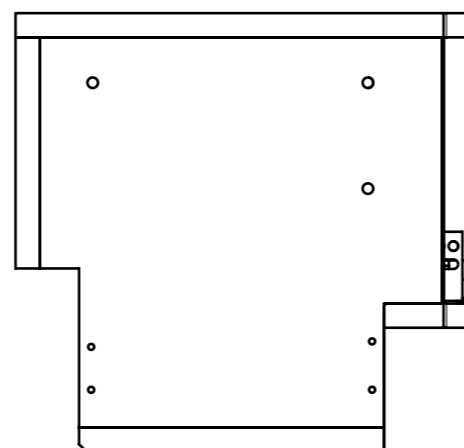
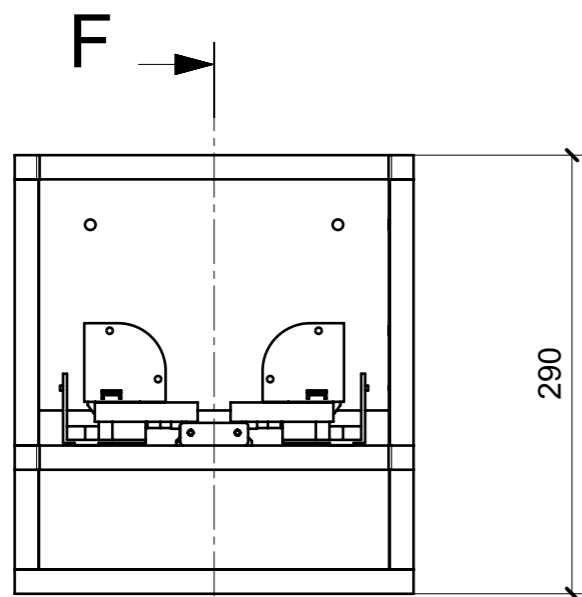

01

SECTION F-F

FERRAMENTA	QTY
CALAMITA SEALED MAGNETIC_TECNOPARTNER_MC-JM50-BL	1
PLACCHETTA COUNTER STEEL_TECNOPARTNER_MC-JM49	1
GUIDA DYNAPRO ADJUSTMENT ADAPTER L_FBC_F134141746 4D	1
GUIDA DYNAPRO SOFTCLOSE L250 L_FBC_F130107790 4D	1
GUIDA DYNAPRO FRONT LOCKING DEVICE L_FBC_F134108955 4D	1
GUIDA DYNAPRO ADJUSTMENT ADAPTER R_FBC_F134141746 4D	1
GUIDA DYNAPRO SOFTCLOSE L250 R_FBC_F130107790 4D	1
GUIDA DYNAPRO FRONT LOCKING DEVICE R_FBC_F134108955 4D	1

LOCALE	CODICE	DESCRIZIONE COMPONENTE	FINITURA	GR.
CABINA OSPITI DX	MD320_RH01	CORNICE TV	OKUME' GREZZO/GREZZO SPRUZZATO NERO	2

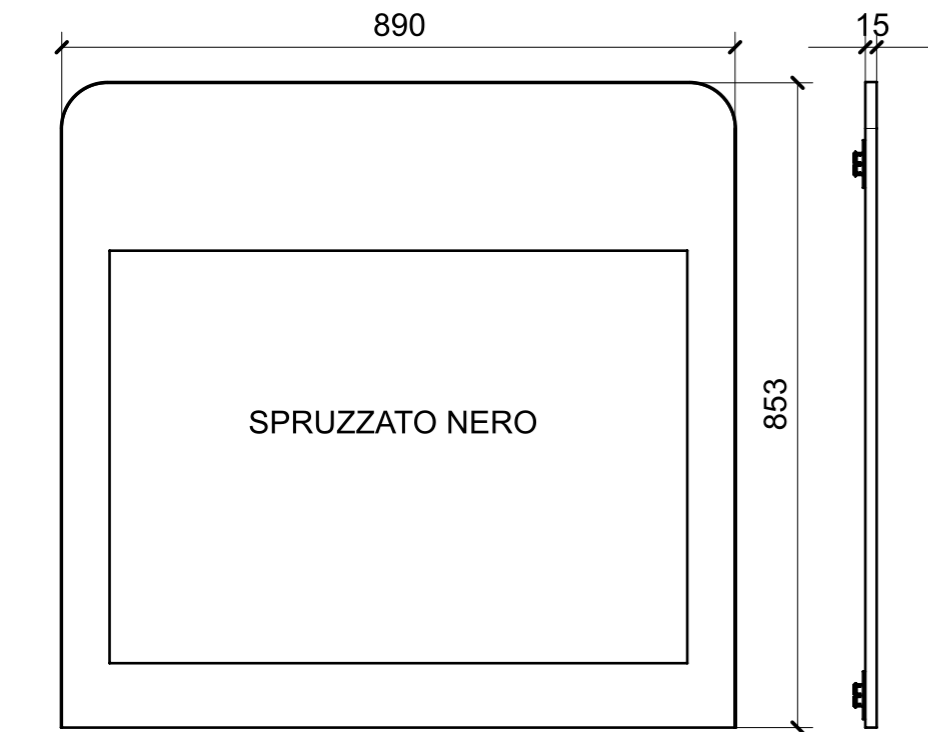

01

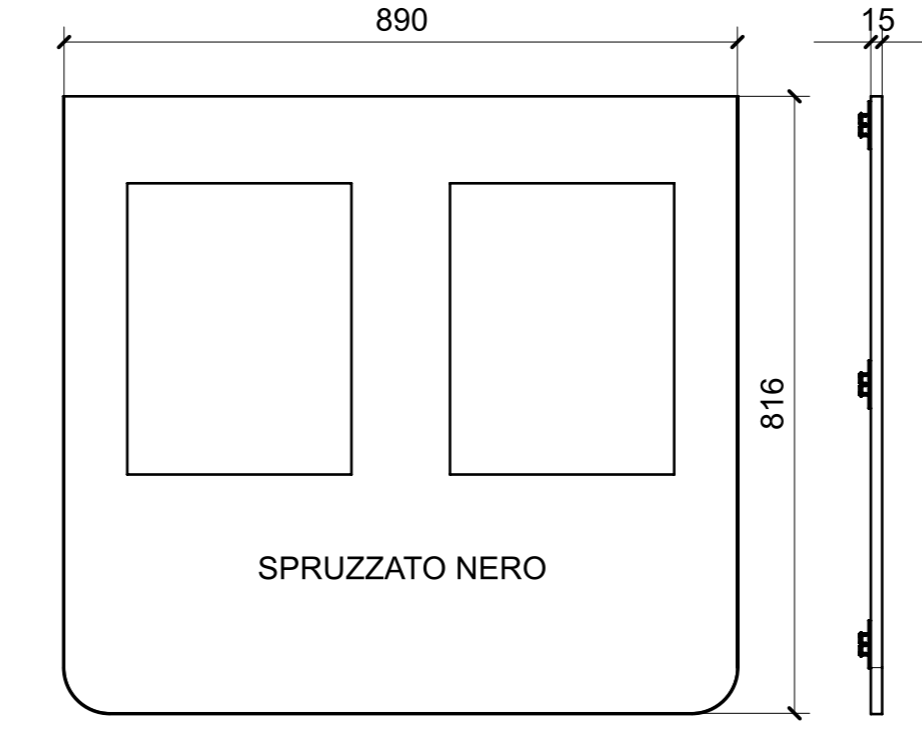

02

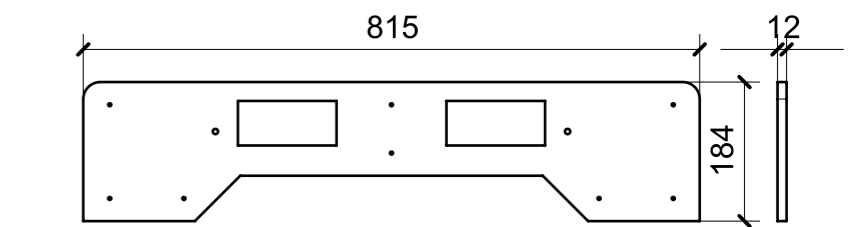

05

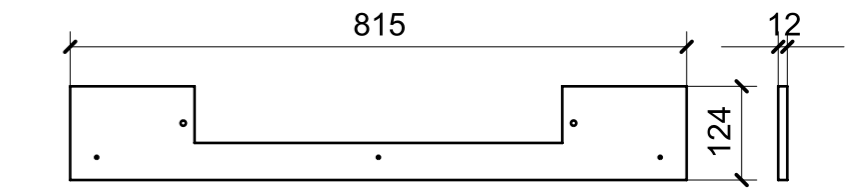

06

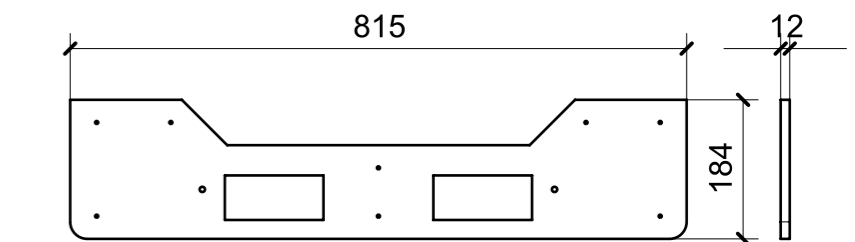

09

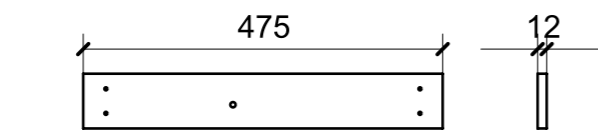

07

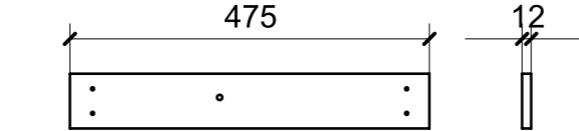

08

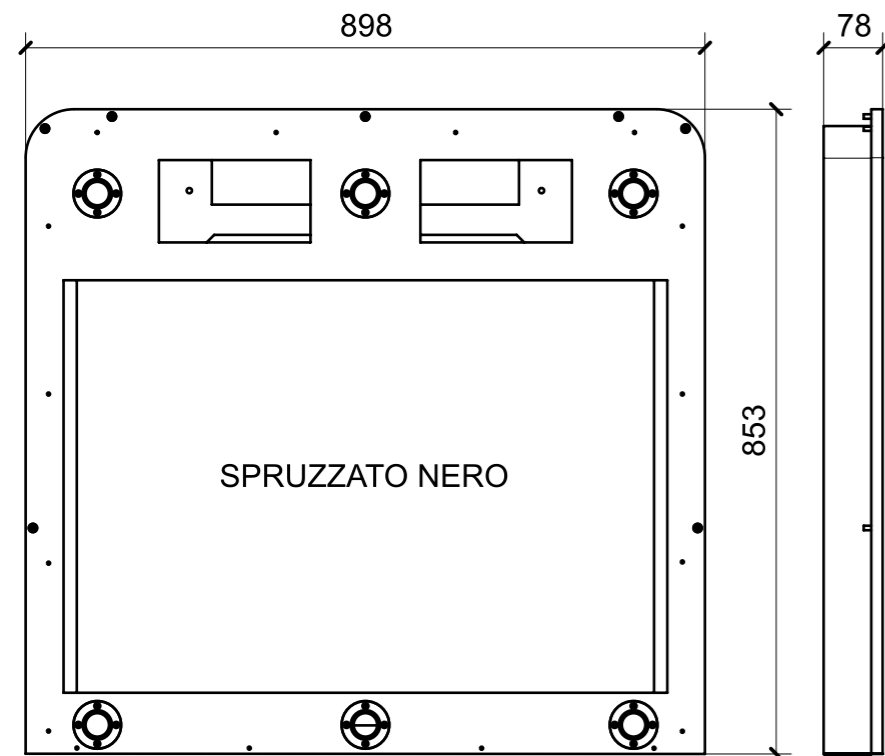

03

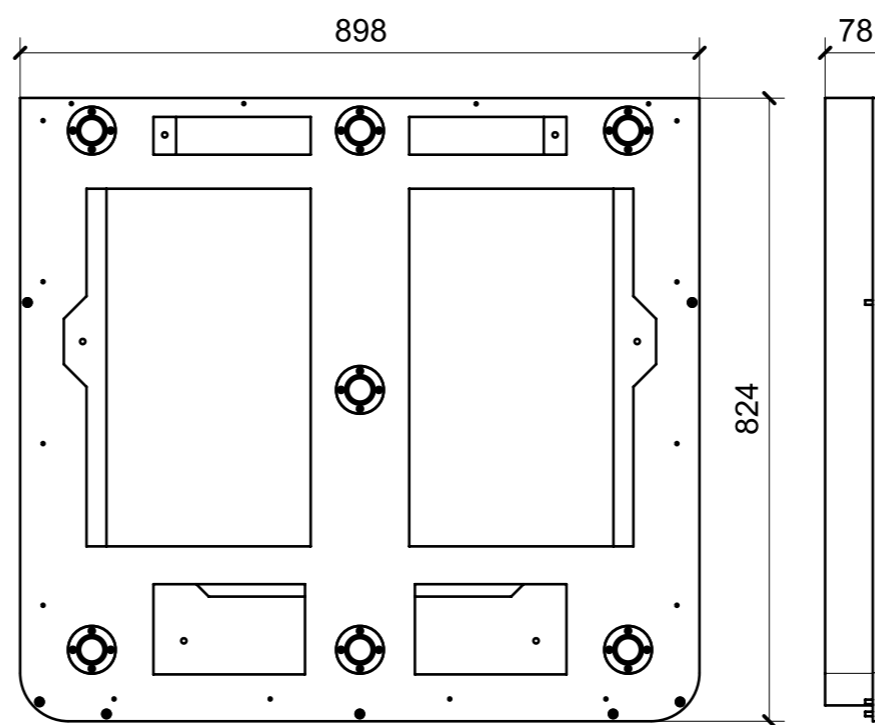

04

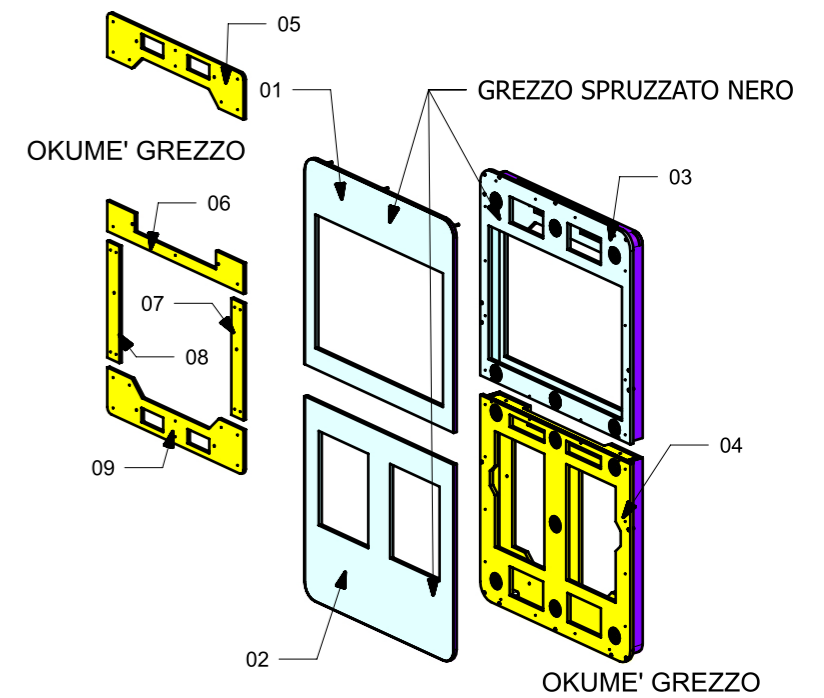

FERRAMENTA	QTY
VITE 6MA X 25 TESTA SVASATA	14
FITLOCK M_MASCHERPA_3MM_6020202101	13
FITLOCK F_MASCHERPA_6020101102	13

LOCALE	CODICE	DESCRIZIONE COMPONENTE	FINITURA	GR.
CABINA OSPITI DX	MD320_RI01	ARMADIO	LAMINATO SMART 0180-2 JUNGLE	2

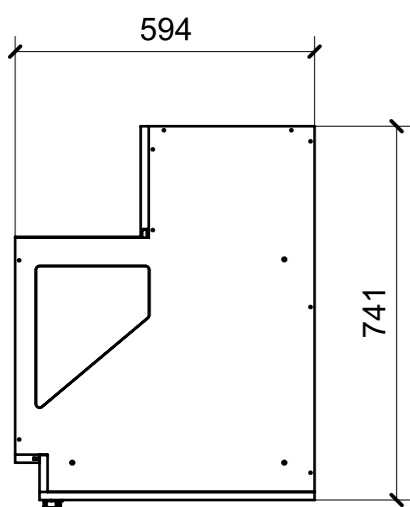
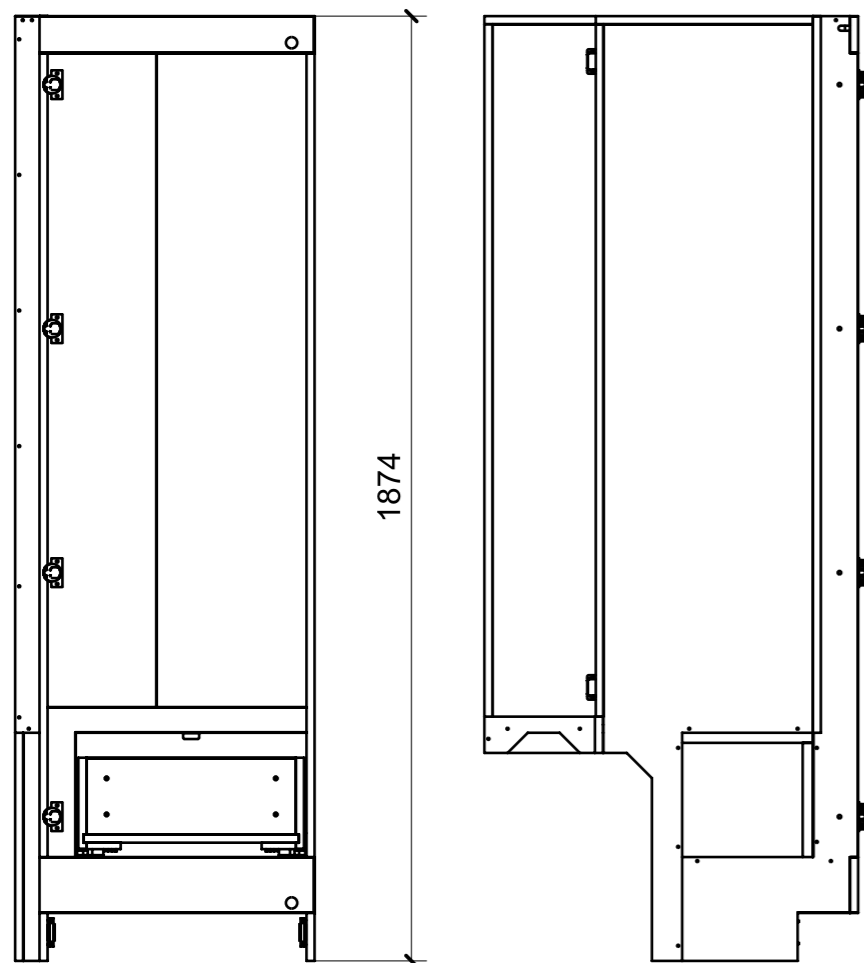

01

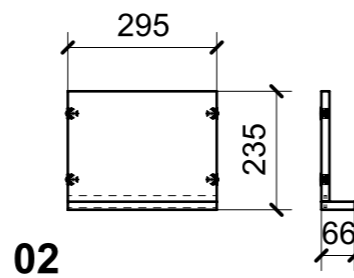

02

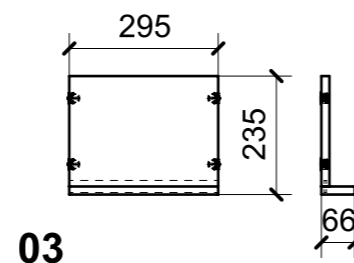

03

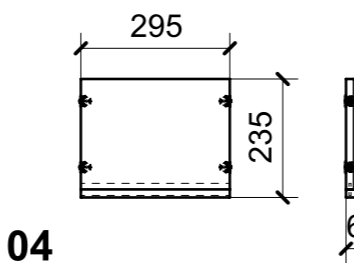

04

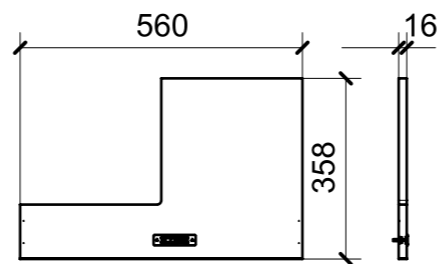

05

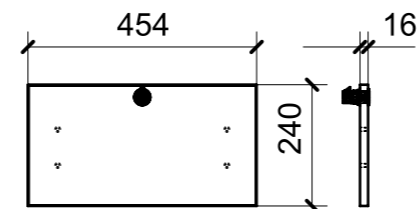

06

ELEMENTI DA MONTARE
in MG_RI01
e spedire con unico imballo

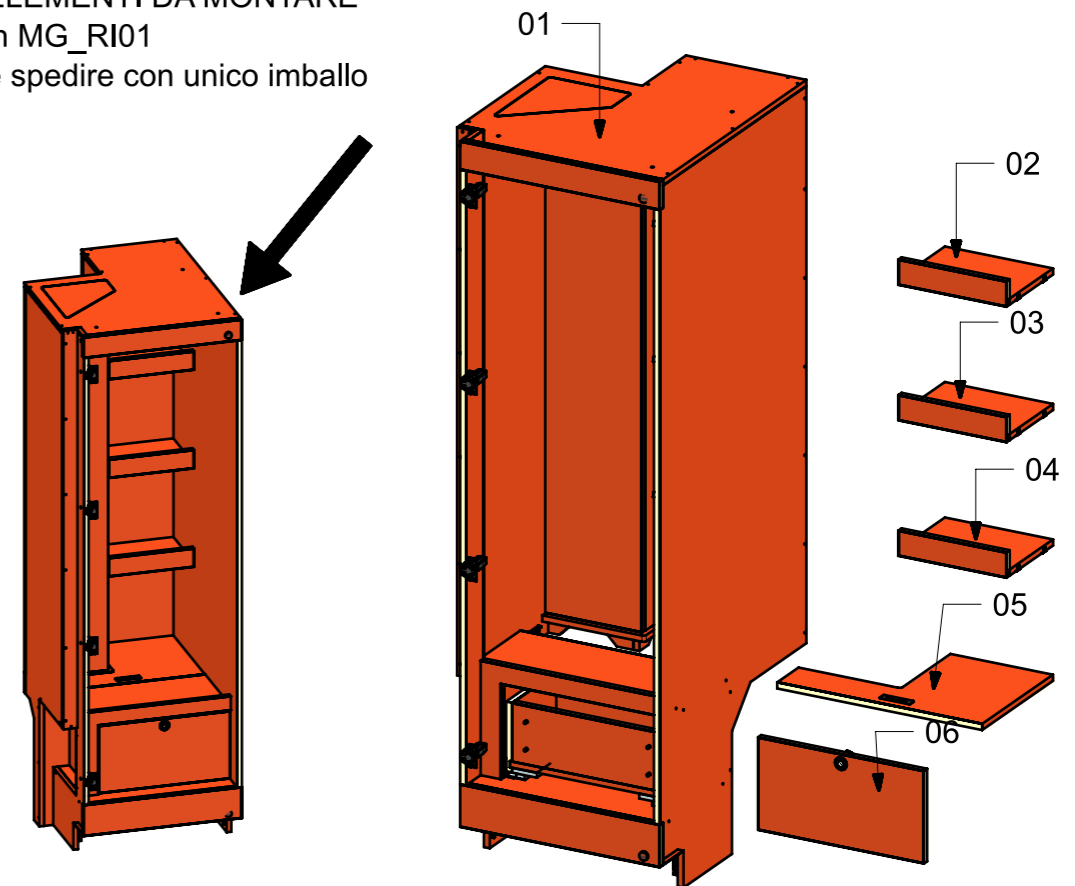

FERRAMENTA	QTY
ALZAPAGLIOLI_FORESTI_164.B BRUNITON	1
BASE_3-NERA_HAFELE_342.22.067-BLUM_175H3130.STP	4
BUSSOLA 5MA ANKOR BORGHI	8
BUSSOLA 6MA X 10 FORO DIAM.8	4
BUSSOLA AD ESPANSIONE_HAFELE_042.98.051	6
CERNIERA 94°_PIANA-NERA_HAFELE_342.46.604-BLUM_71B9550.STP	4
CHIUSURA A SPINTA_TECHNOPARTNER_SOU C3-203	6
COPERTURA BRACCIO CERNIERA NERO-HAFELE_342.94.602-BLUM_70.1503.STP	4
GIUNTO REGGIRIPIANO CON BORDO ANTISGANCIO_FBC BORGHI_1033XXB060902	12
GIUNTO REGGIRIPIANO_HAFELE_262.36.510	12
GUIDA DYNAPRO ADJUSTAMENT ADAPTER L_FBC_F134141746 4D	1
GUIDA DYNAPRO ADJUSTAMENT ADAPTER R_FBC_F134141746 4D	1
GUIDA DYNAPRO FRONT LOCKING DEVICE L_FBC_F134108955 4D	1
GUIDA DYNAPRO FRONT LOCKING DEVICE R_FBC_F134108955 4D	1
GUIDA DYNAPRO SOFTCLOSE L250 L_FBC_F130107790 4D	1
GUIDA DYNAPRO SOFTCLOSE L250 R_FBC_F130107790 4D	1
KEEPER PUSH TO CLOSE_SOUTCHO-J-M1-519-4_TECHNOPARTNER	1
KIT LED PER ARMADIO MD320 RI01 MM 512_	1
MAGNETE FORZA MAGNETICA1-5 10KG_HAFELE_246.87.112	2
PERNO LISCIO PER SPALLA_FBC BORGHI_1033PXX050531	12
PUSH TO CLOSE_SOUTHCO-MP-05-312-55 NERA_TECHNOPARTNER	2
VITE 4MA X 12 TESTA SVASATA ESAGONALE NERA_FBC	2
VITE 4MAX8 ANKOR BORGHI	8
VITE 6MA X 25 TESTA BOMBATA NERA BHCS 10.9 ISO 7380	4

LOCALE	CODICE	DESCRIZIONE COMPONENTE	FINITURA	GR.
CABINA OSPITI DX	MD320_RL01	CIELINO	CARTA MELAMINICA NERA	2

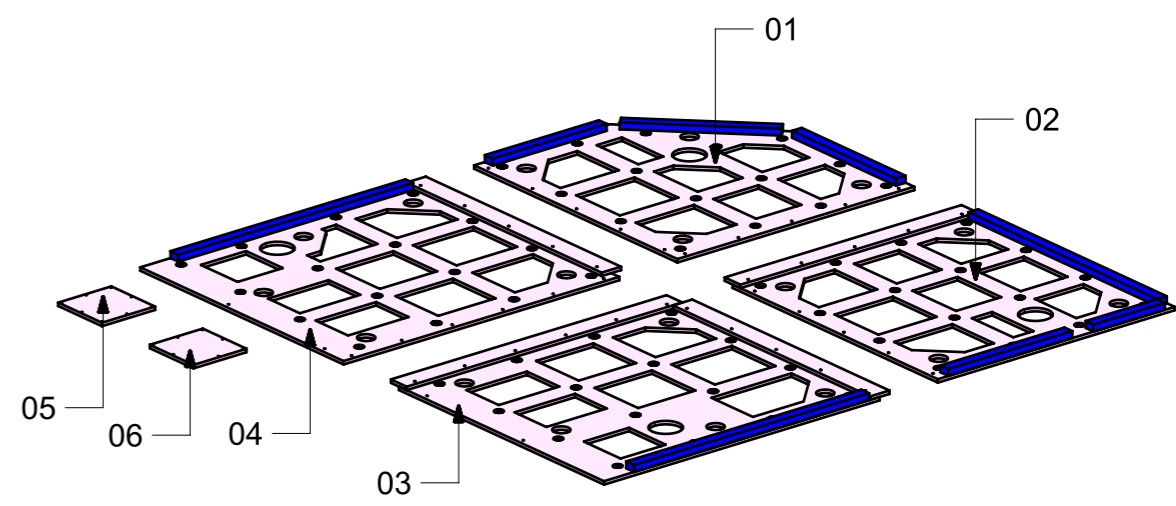
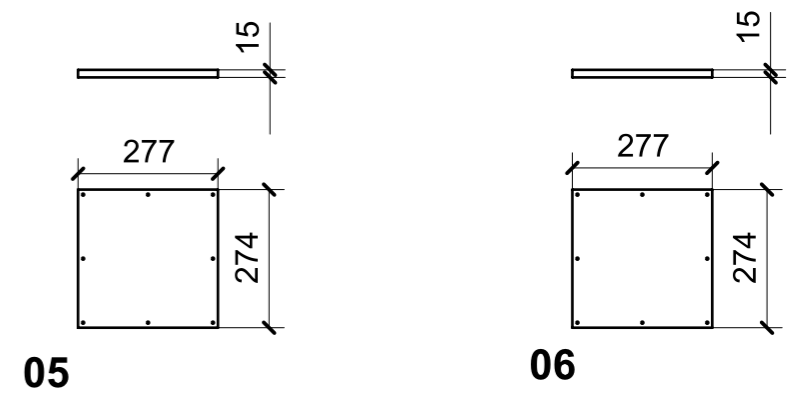
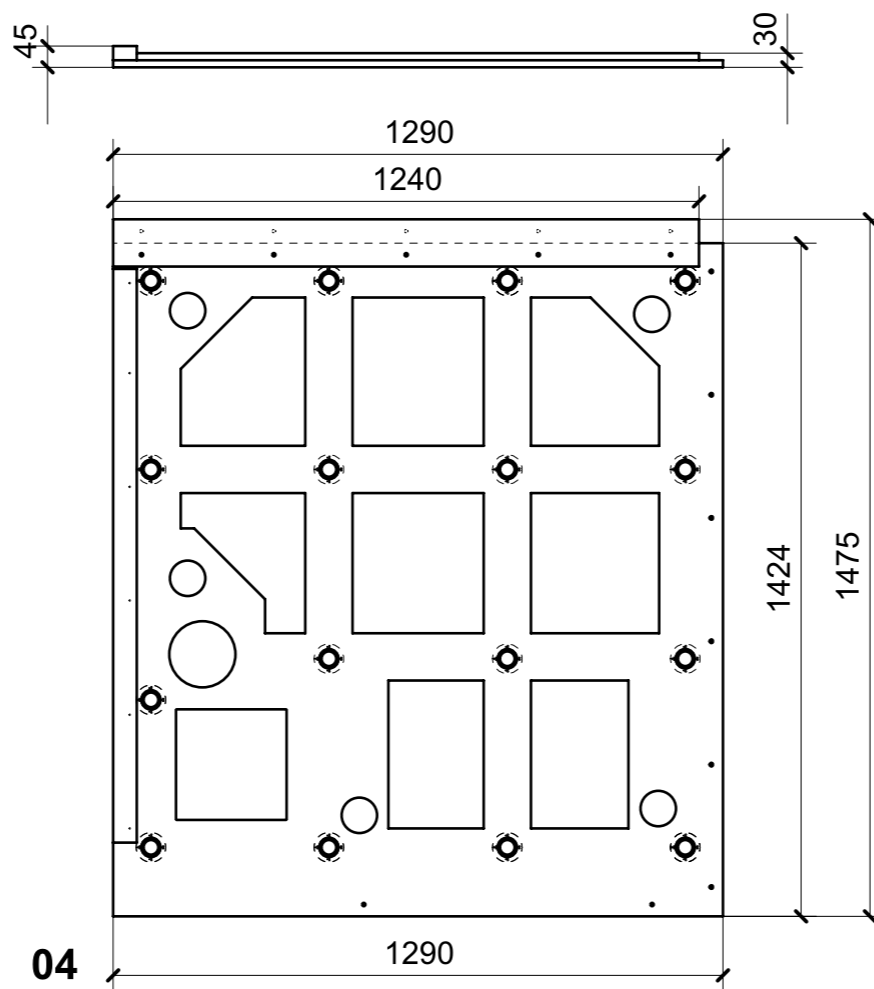
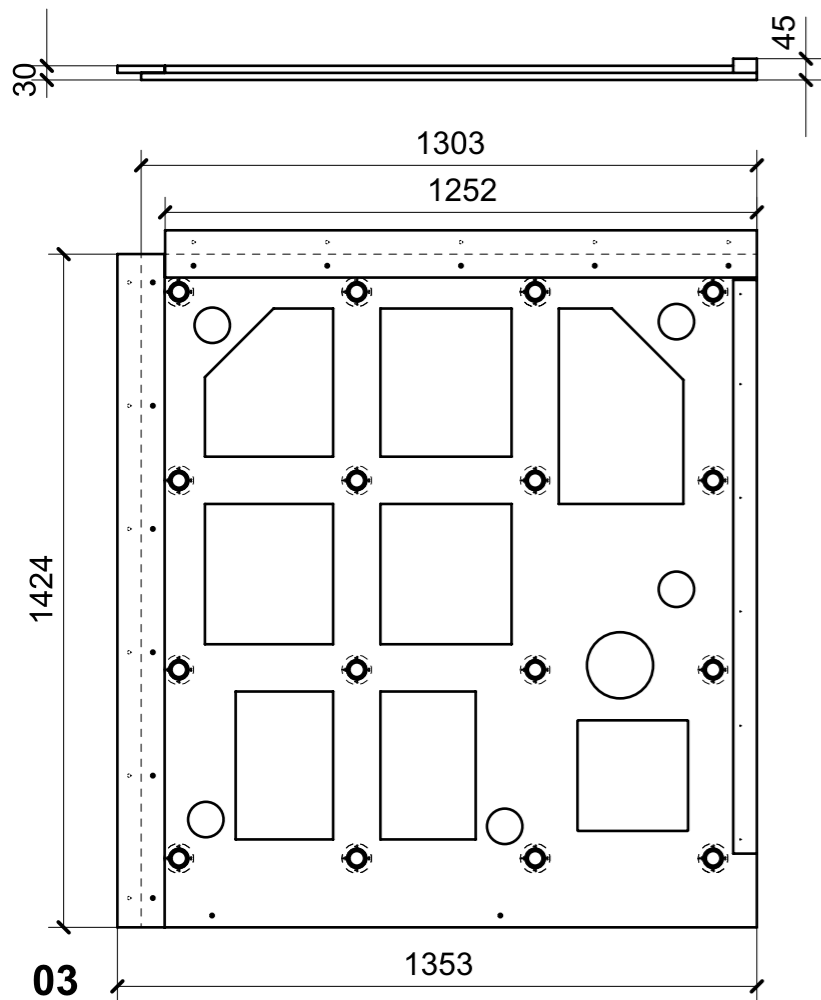
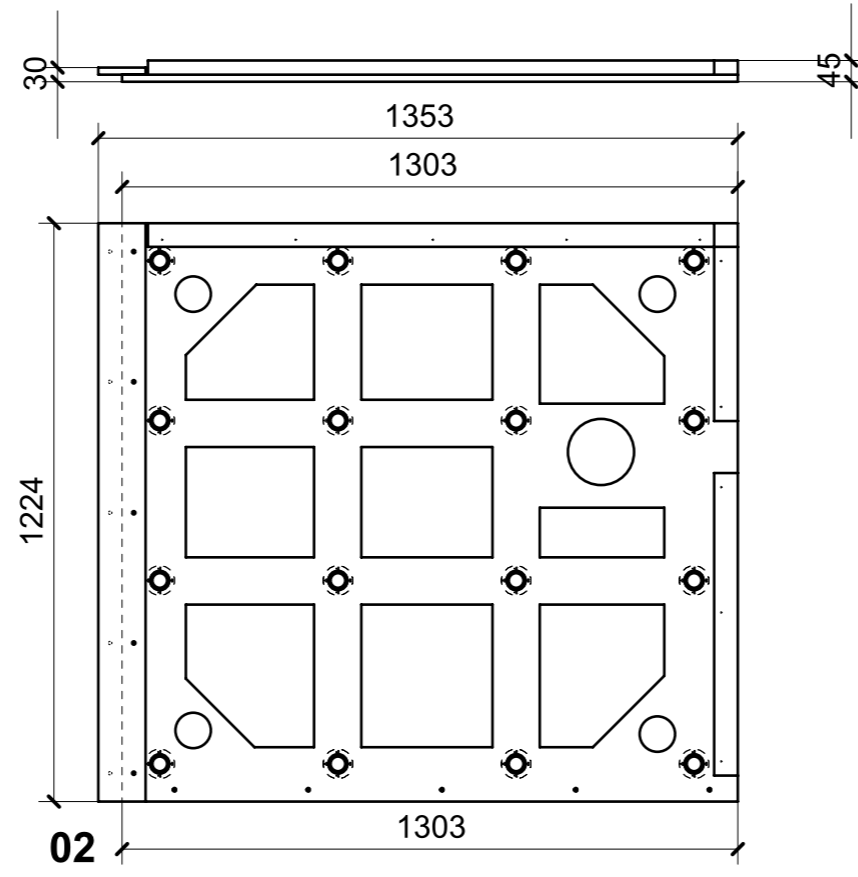
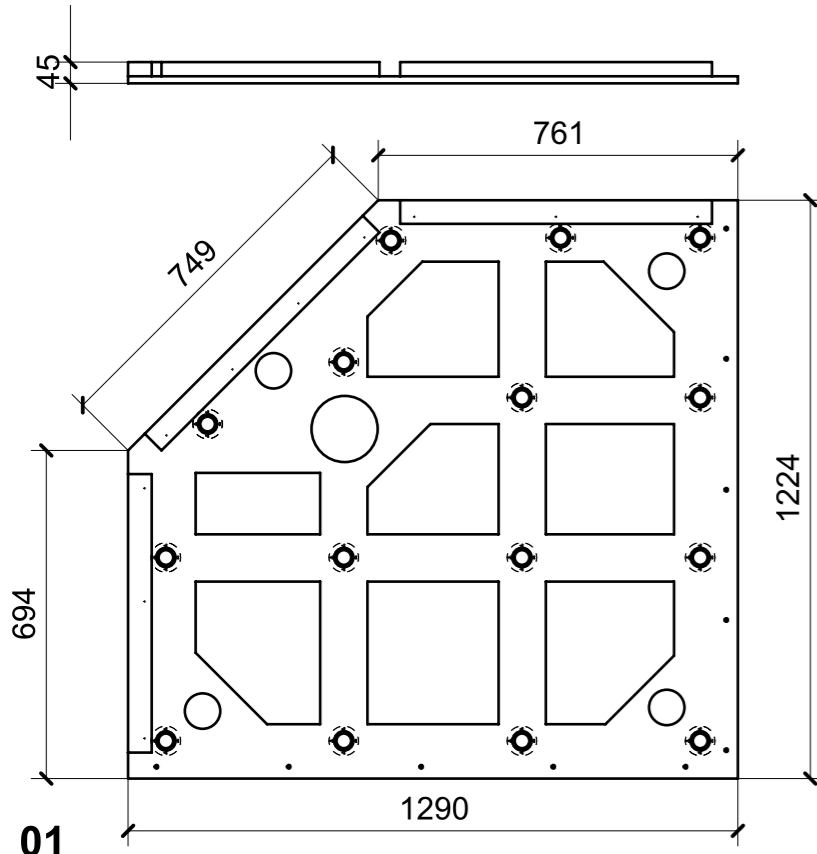

FERRAMENTA	QTY
FITLOCK F_MASCHERPA_6020101102	63

LOCALE	CODICE	DESCRIZIONE COMPONENTE	FINITURA	GR.
CABINA OSPITI DX	MD320_RM01	PLENUM ARMADIO	VERNICIATO ANTI ROMBO	2

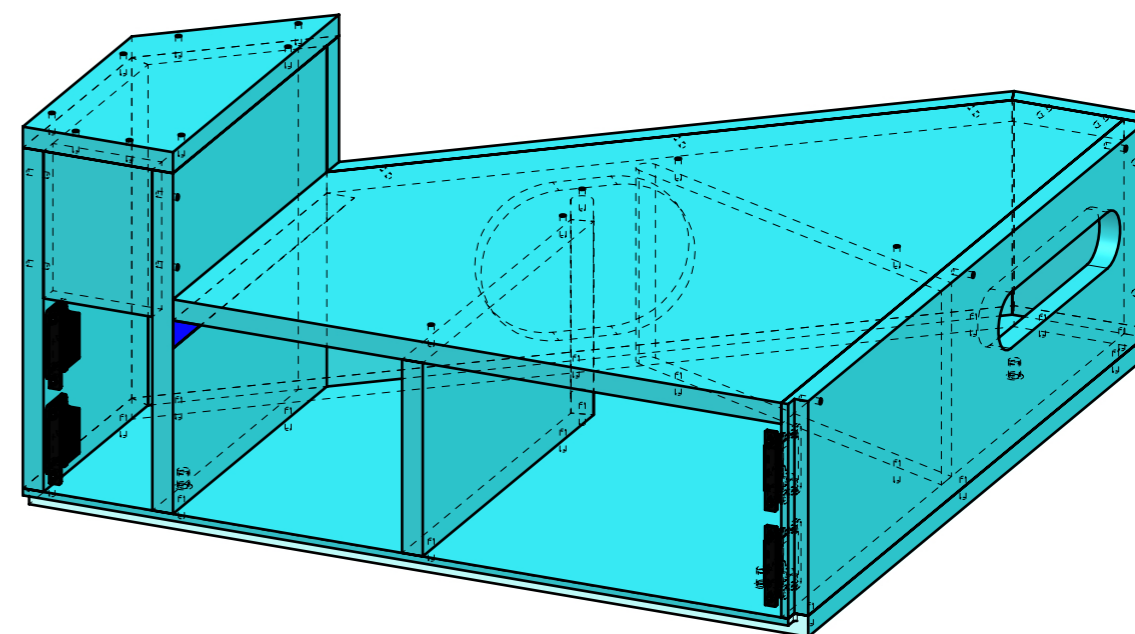
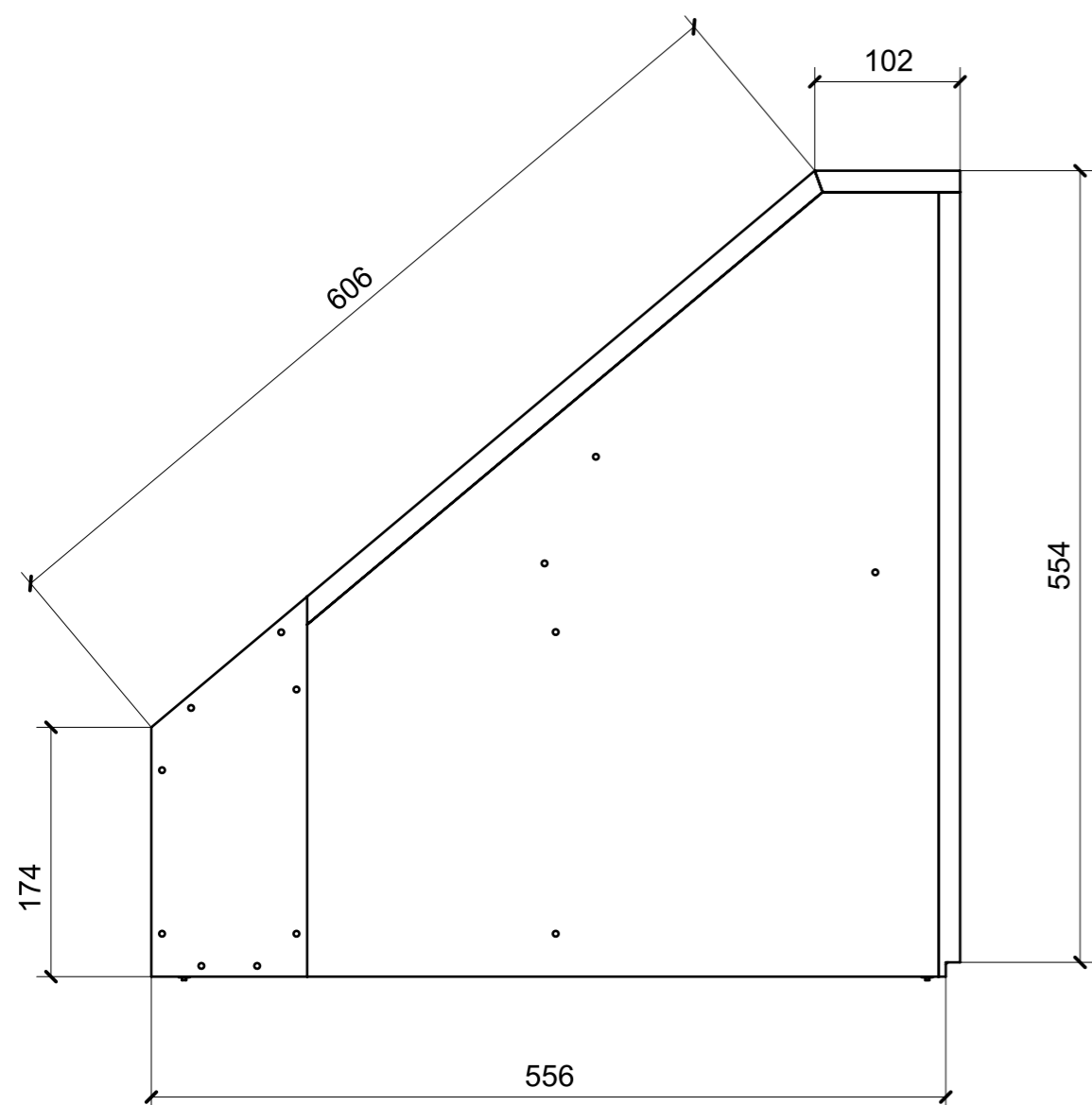
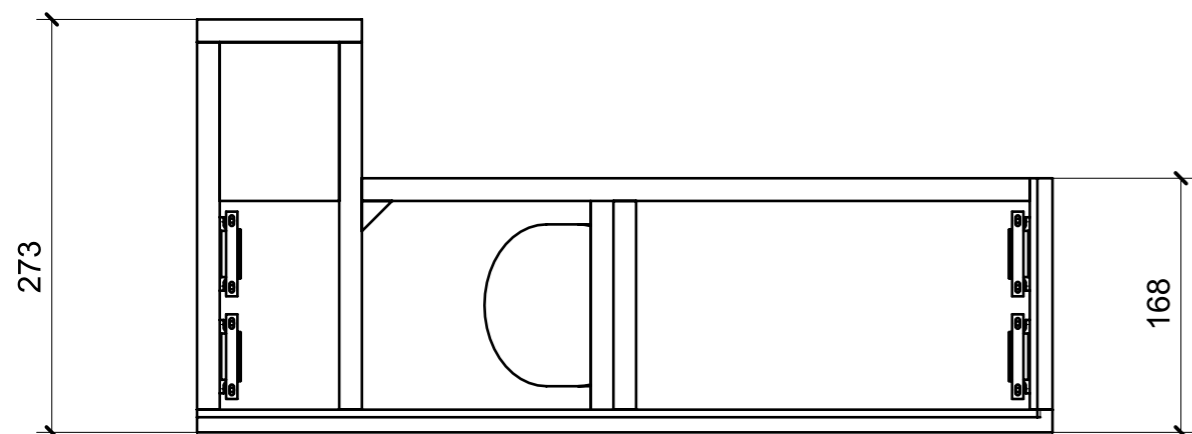

FERRAMENTA	QTY
CHIUSURA A SPINTA_TECHNOPARTNER_SOU C3-203	4
BUSSOLA 6MA X 10 FORO DIAM.8	3

LOCALE	CODICE	DESCRIZIONE COMPONENTE	FINITURA	GR.
CABINA OSPITI DX	MD320_RN01	SPESSORAMENTO VASSOIO ZONA COMODINO POPPA	OKUME' GREZZO	PTP

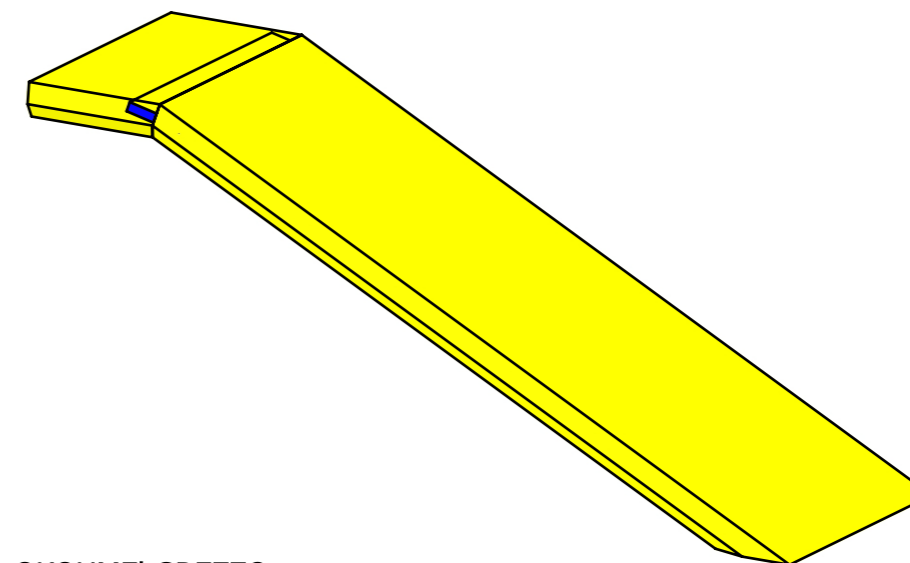
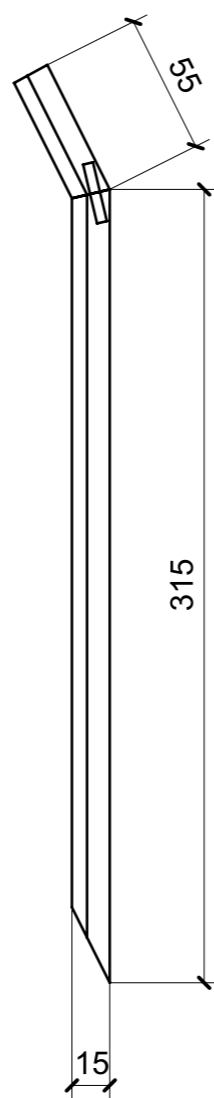
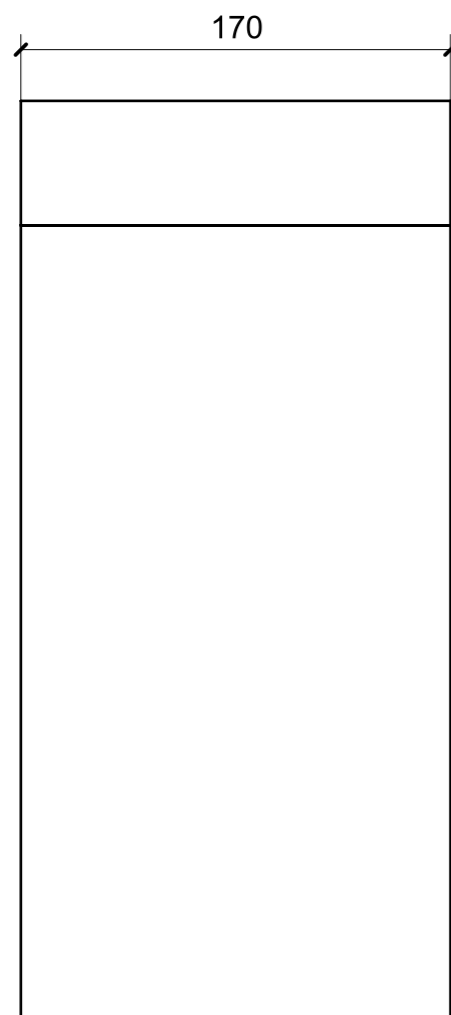

OKOUME' GREZZO