

LOCALE	CODICE	DESCRIZIONE COMPONENTE	FINITURA	GR.
PARATIE	MD320_PR10	PARATIA BAGNO_CABINA VIP DX MURATA	LARICROSS	PTP

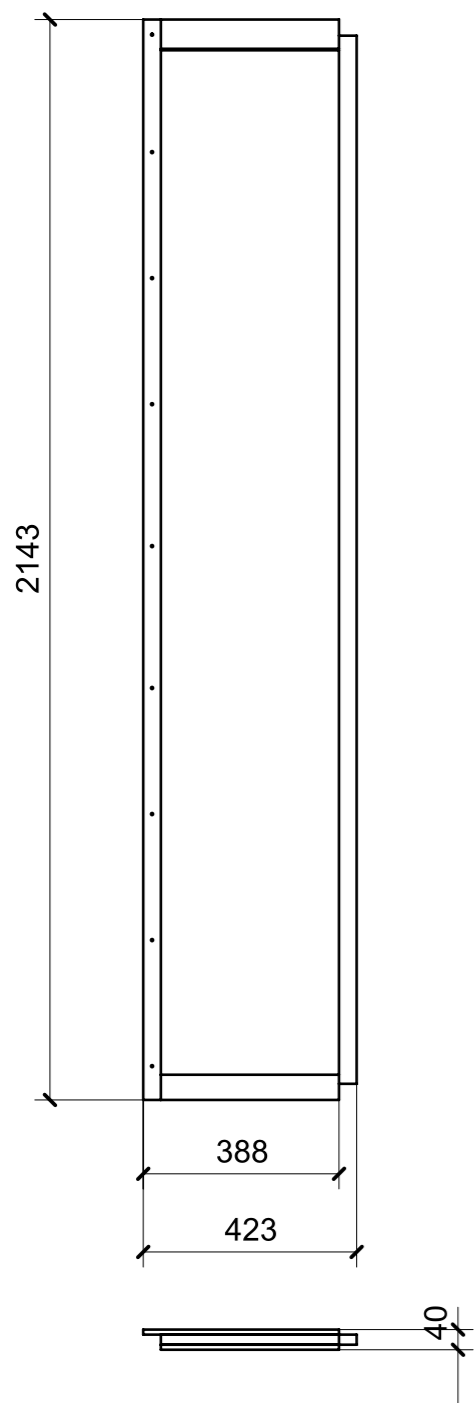

01

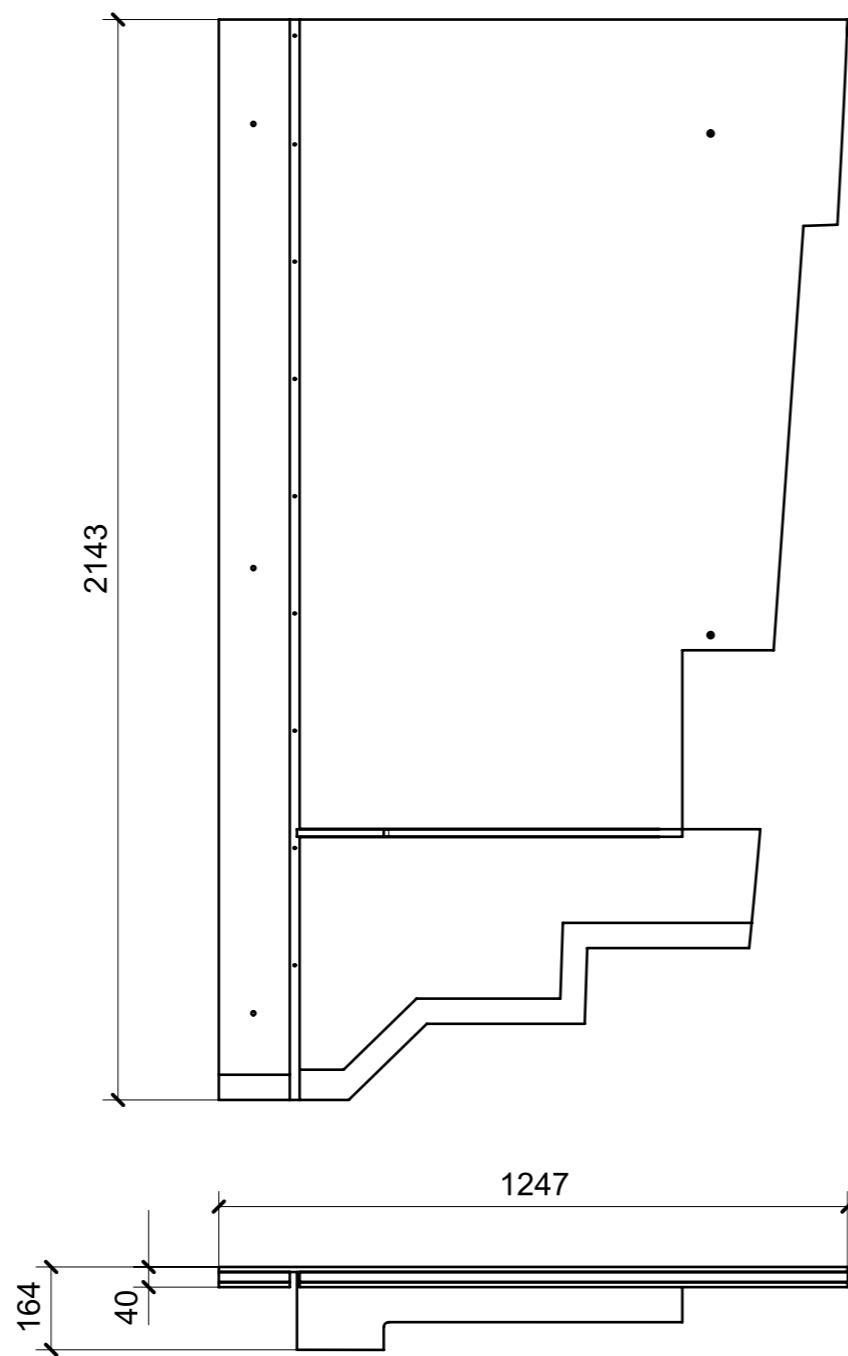

02

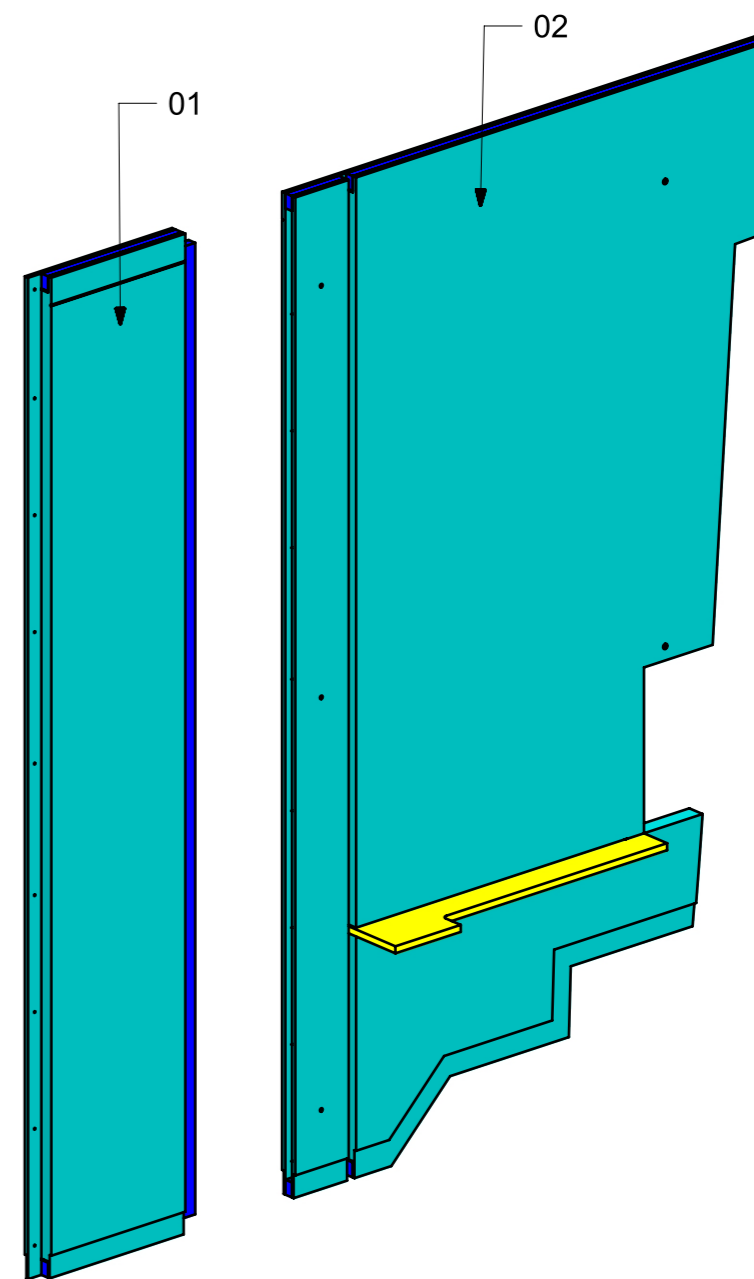

FERRAMENTA	QTY
BUSSOLA 6MA X 10 FORO DIAM.8	4

LOCALE	CODICE	DESCRIZIONE COMPONENTE	FINITURA	GR.
PARATIE LD	MD320_PR11	PARATIA PORTA BAGNO VIP DX	OKUME' GREZZO	2

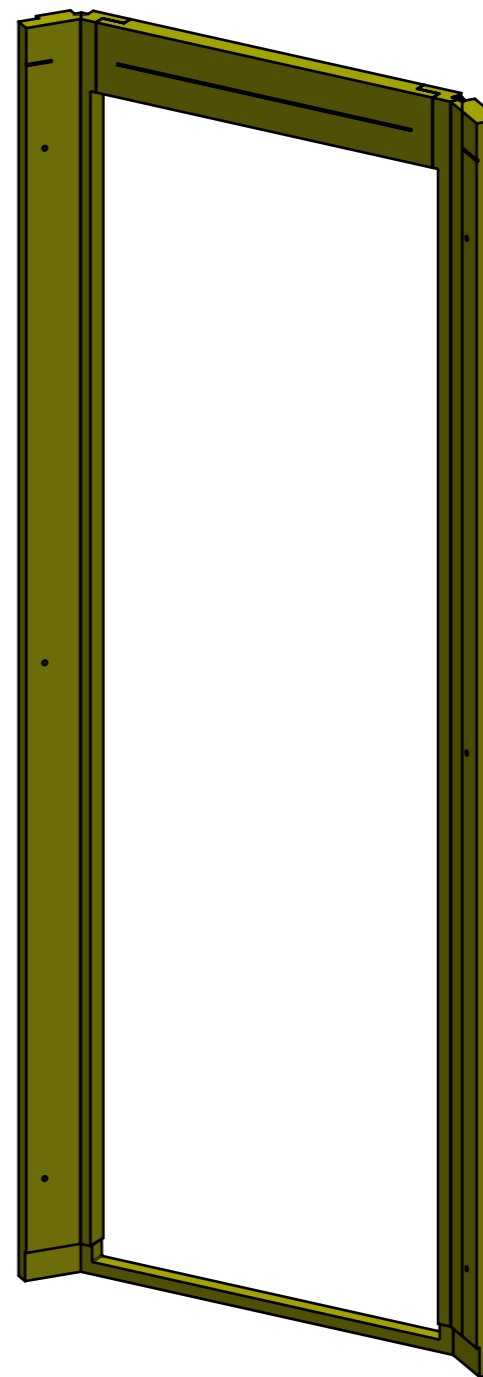
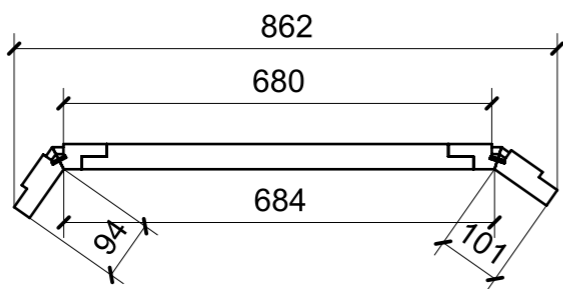
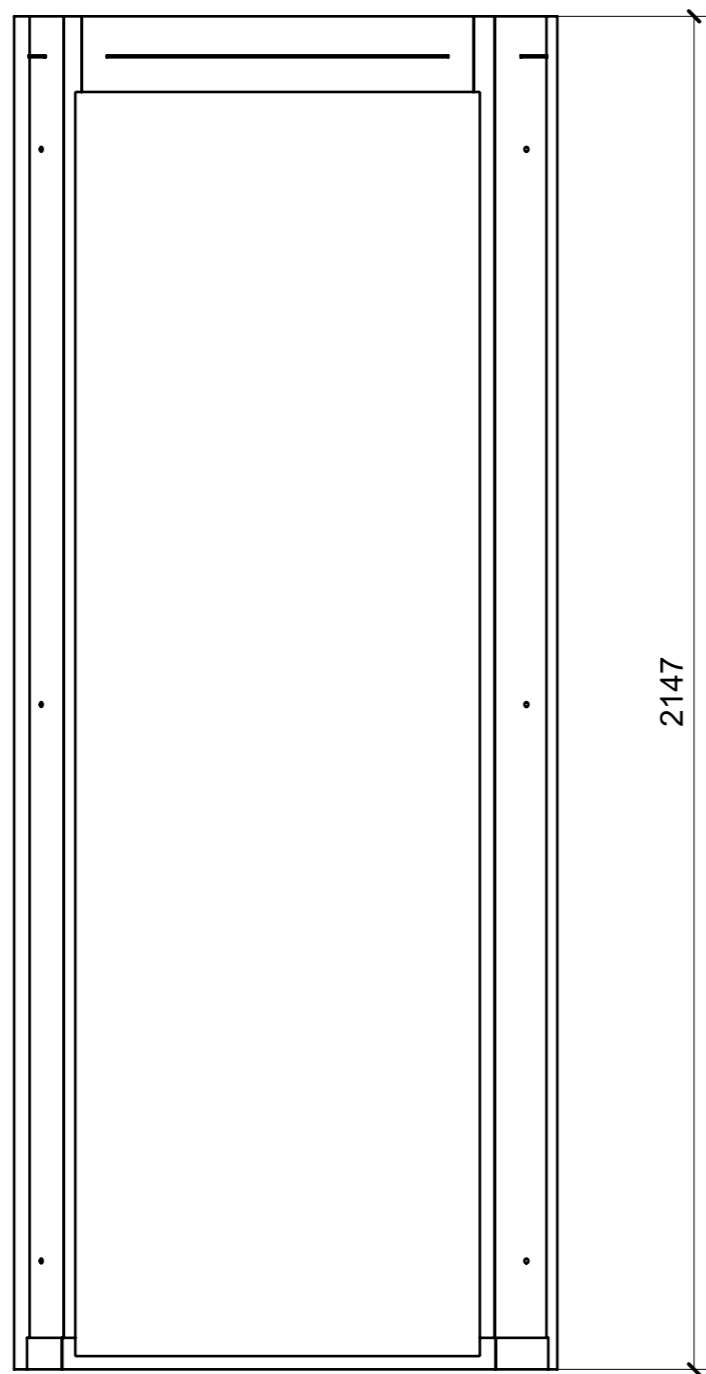

01

LOCALE	CODICE	DESCRIZIONE COMPONENTE	FINITURA	GR.
PARATIE LD	MD320_PR12	PARATIA BAGNO VIP DX CENTRO NAVE	LARICROSS/GREZZO	2

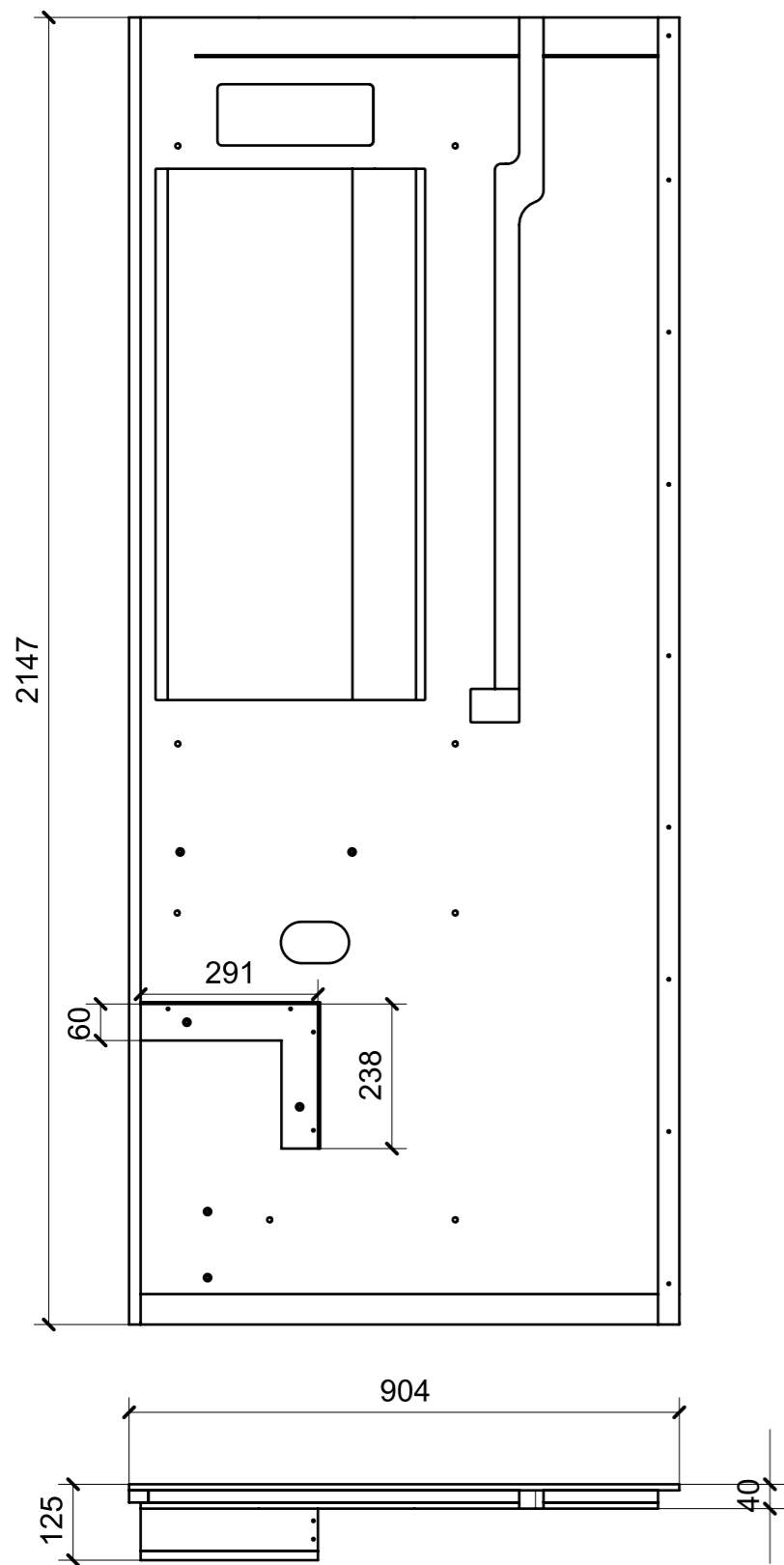

01

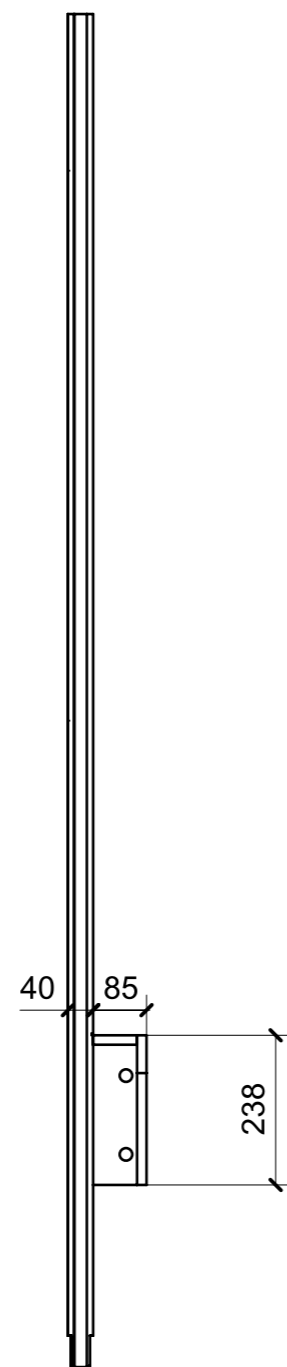

GREZZO
SPRUZZATO NERO

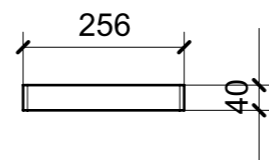

02

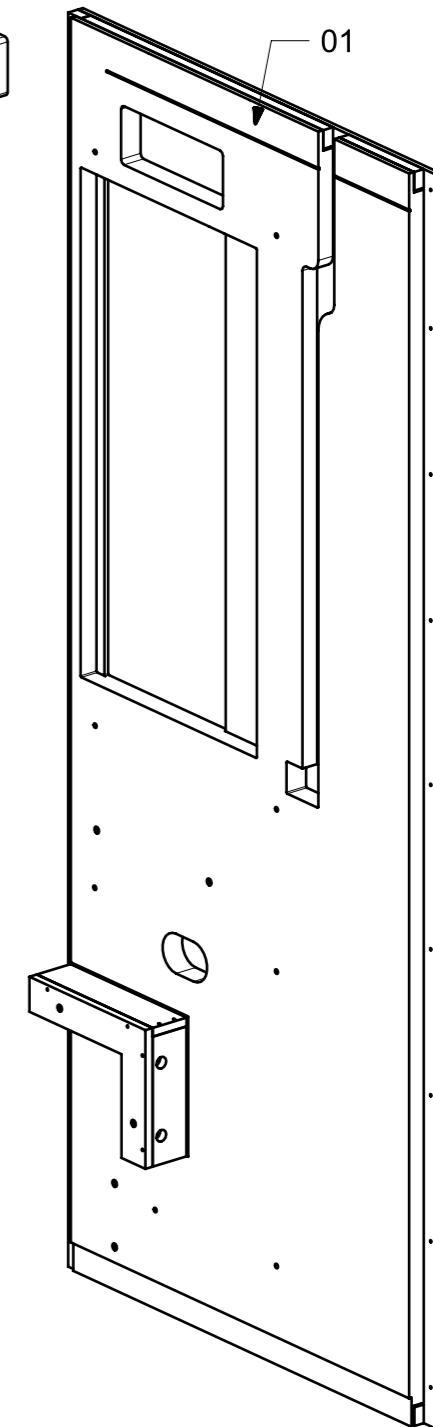
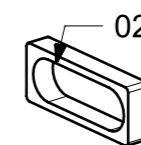

FERRAMENTA	QTY
BUSSOLA 6MA X 10 FORO DIAM.8	8

LOCALE	CODICE	DESCRIZIONE COMPONENTE	FINITURA	GR.
PARATIE LD	MD320_PR13	PARATIA BAGNO VIP DX PORTA DOCCIA	OKUME' GREZZO	PTP

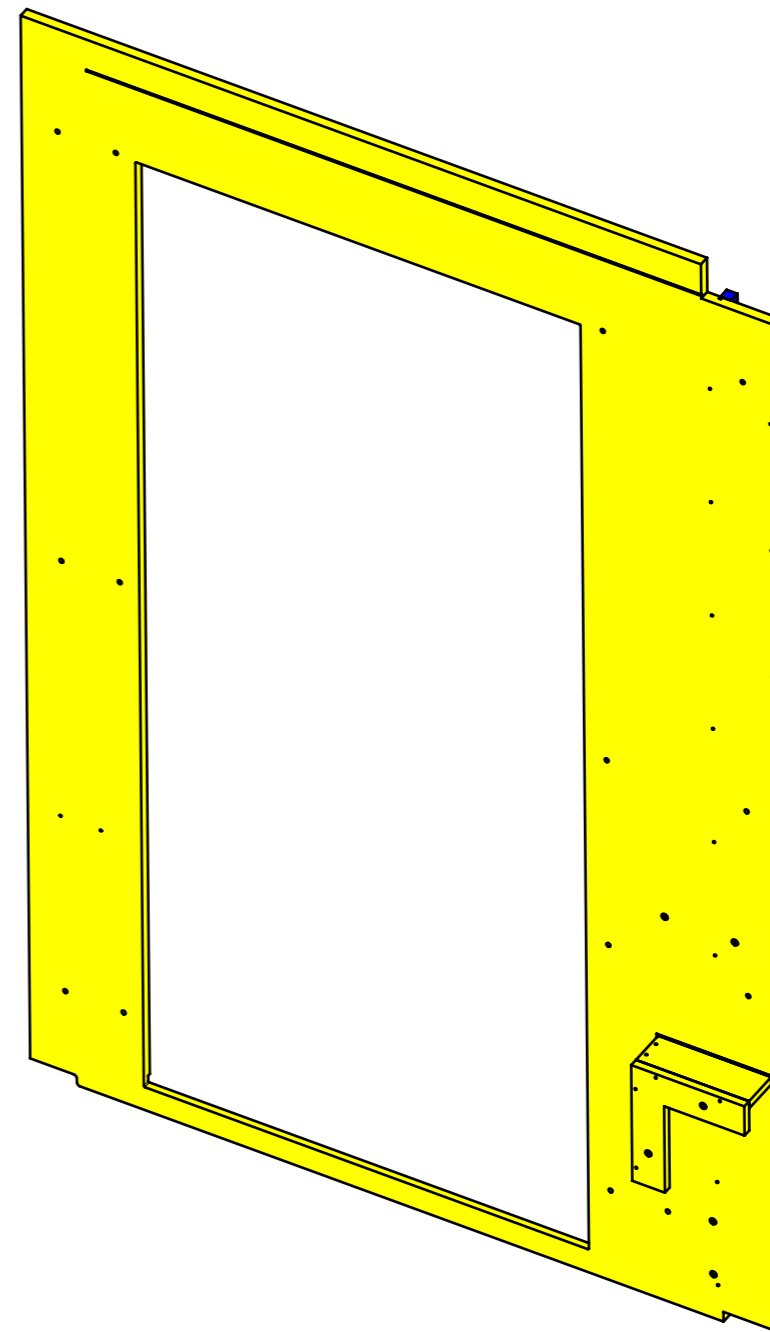
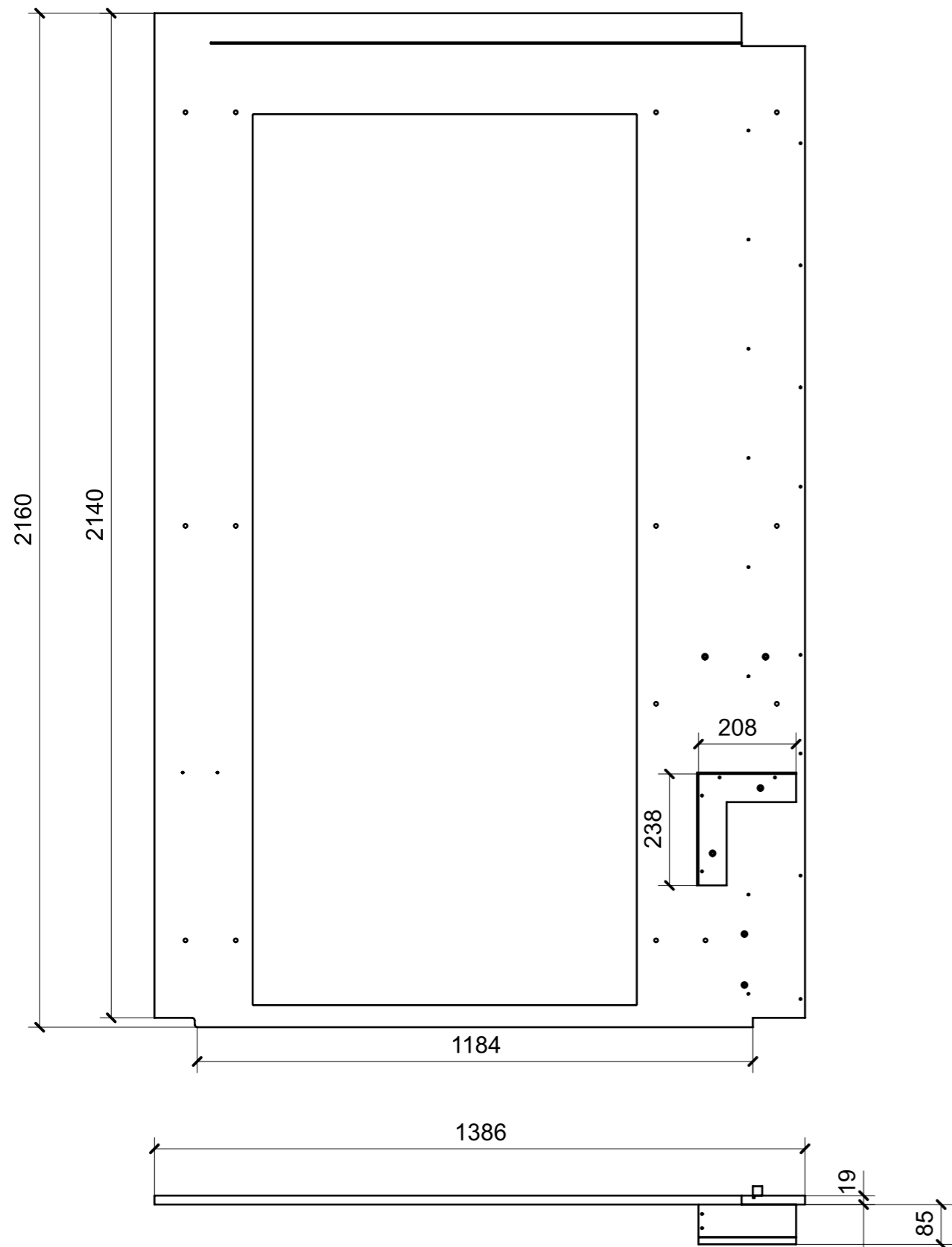

01

FERRAMENTA	QTY
BUSSOLA 6MA X 10 FORO DIAM.8	6

LOCALE	CODICE	DESCRIZIONE COMPONENTE	FINITURA	GR.
PARATIE LD	MD320_PR14	PARATIA BAGNO VIP DX POPPA MURATA	OKUME' GREZZO	2

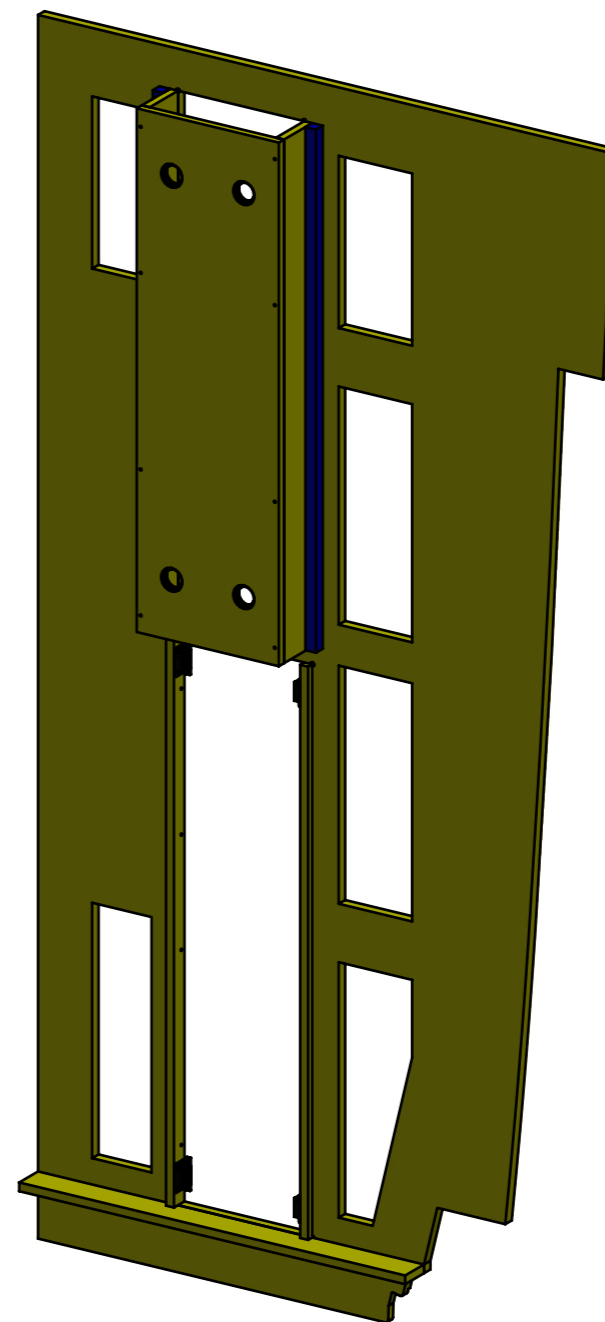
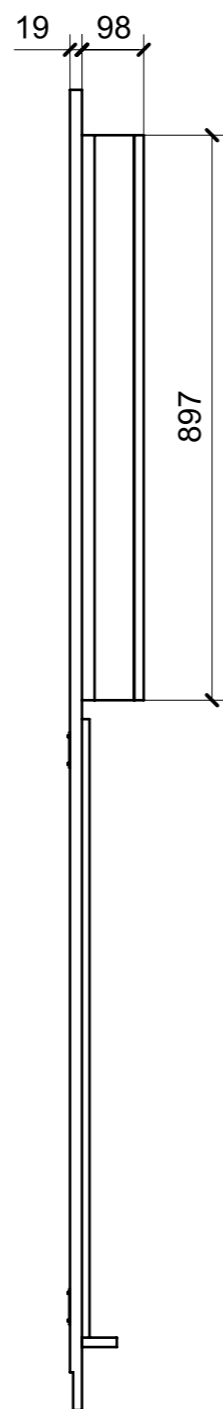
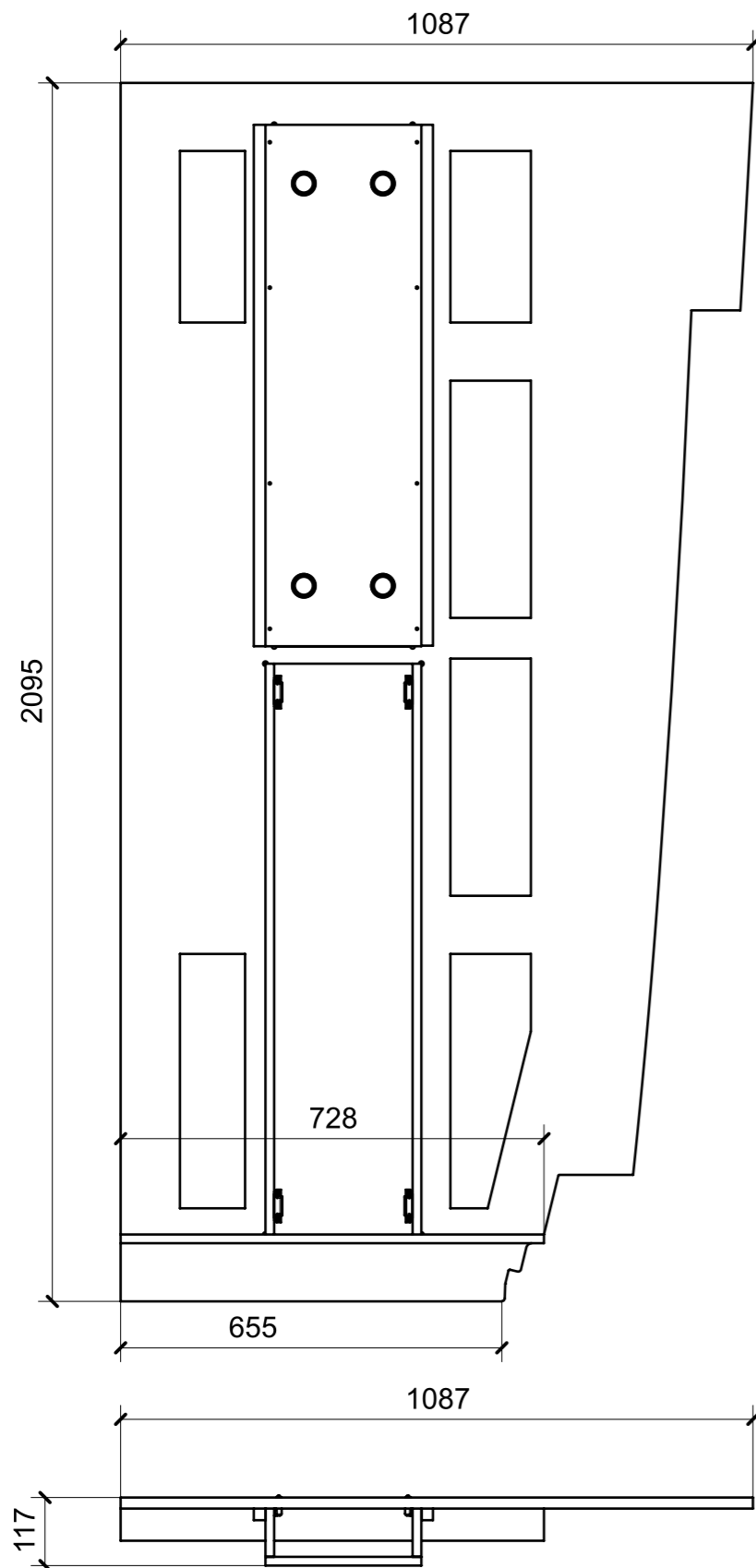

01

FERRAMENTA	QTY
BUSSOLA 6MA X 10 FORO DIAM.8	3
FITLOCK F_MASCHERPA_6020101102	4
CHIUSURA A SPINTA_TECHNOPARTNER_SOU C3-203	4

LOCALE	CODICE	DESCRIZIONE COMPONENTE	FINITURA	GR.
PARATIE LD	MD320_PR15	PARATIA BAGNO VIP DX POPPA LAVABO	CARTA MELAMINICA NERA/OKUME' GREZZO	2

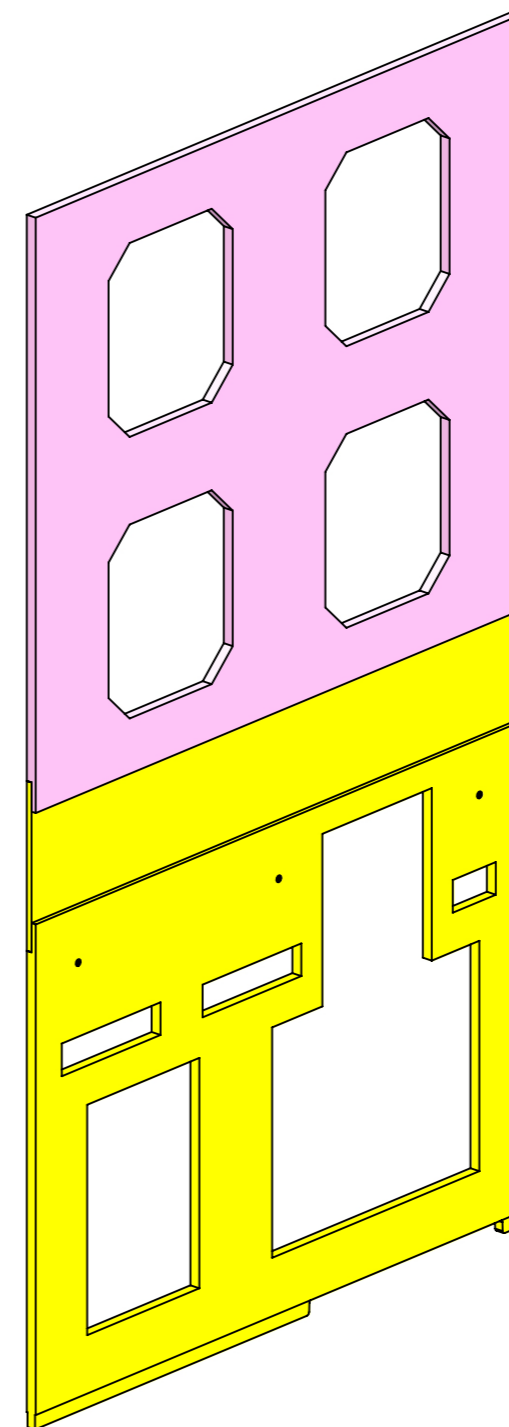
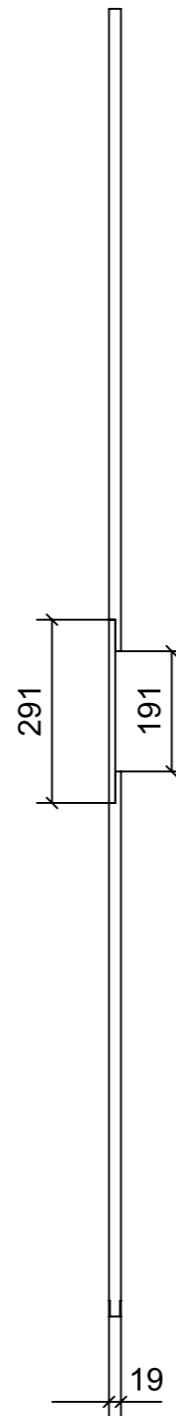
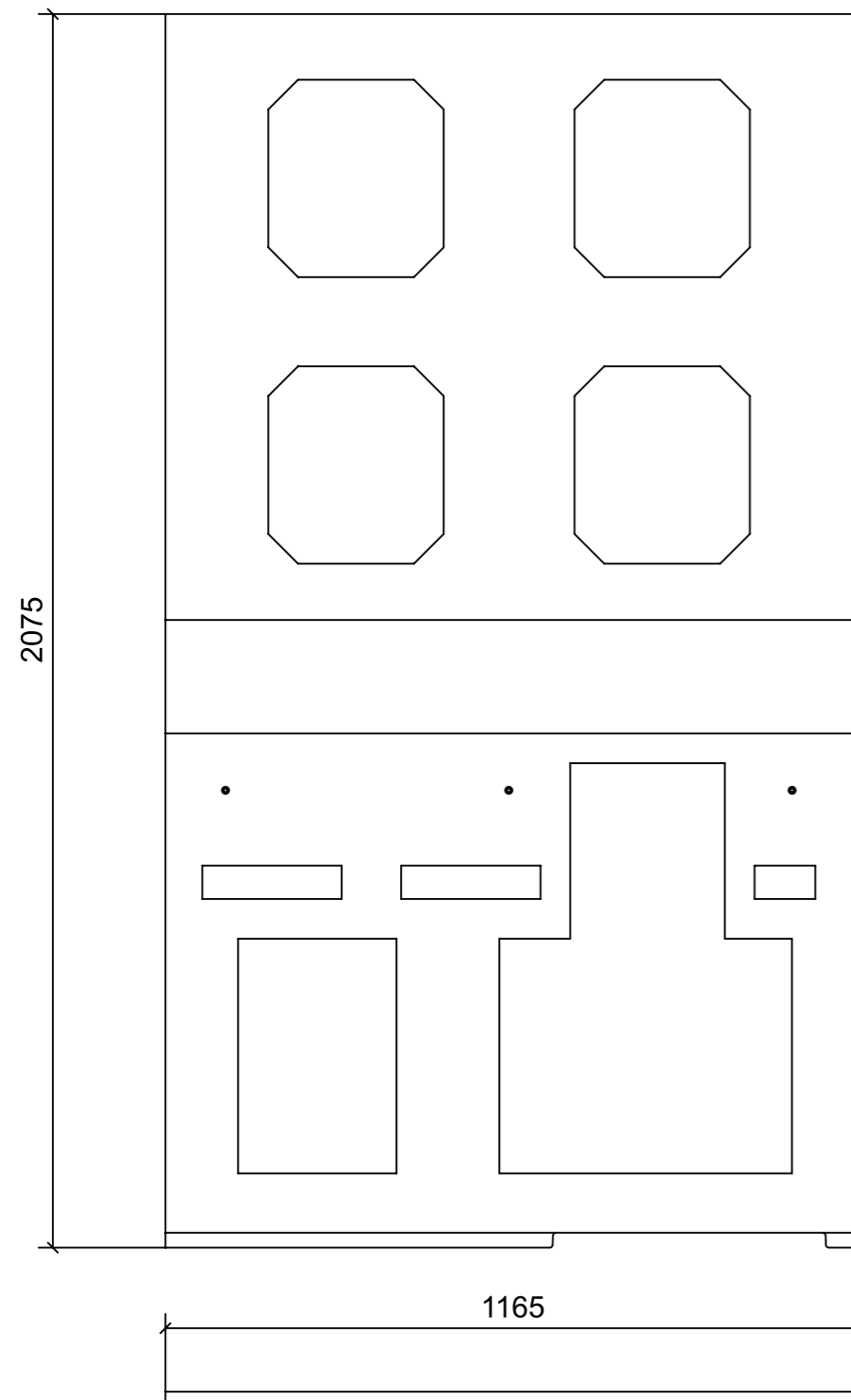

01

FERRAMENTA	QTY
BUSSOLA 6MA X 10 FORO DIAM.8	3

LOCALE	CODICE	DESCRIZIONE COMPONENTE	FINITURA	GR.
PARATIE LD	MD320_PR16	PARATIA BAGNO_CABINA VIP SX MURATA	LARICROSS / OKUME' GREZZO	PTP

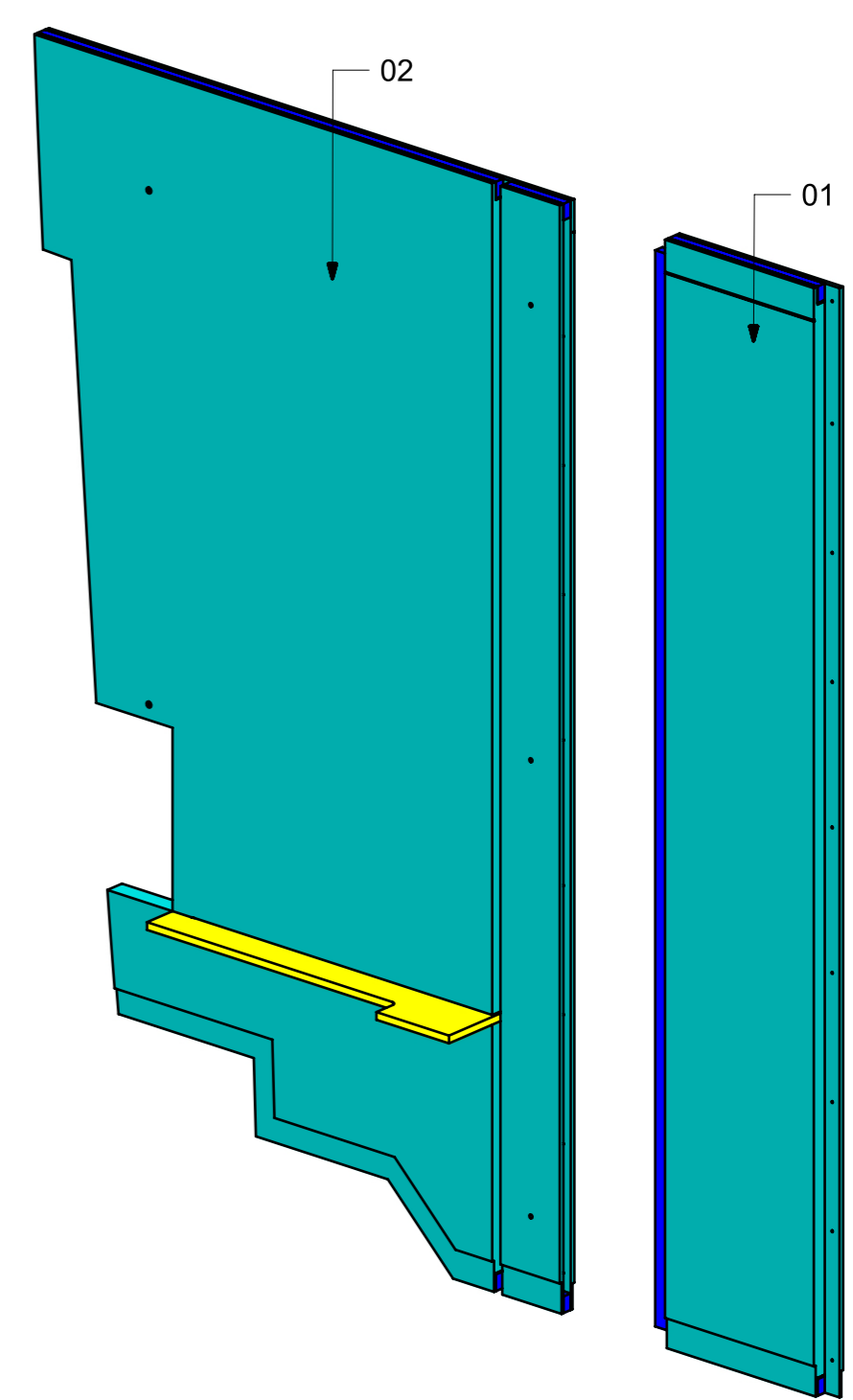
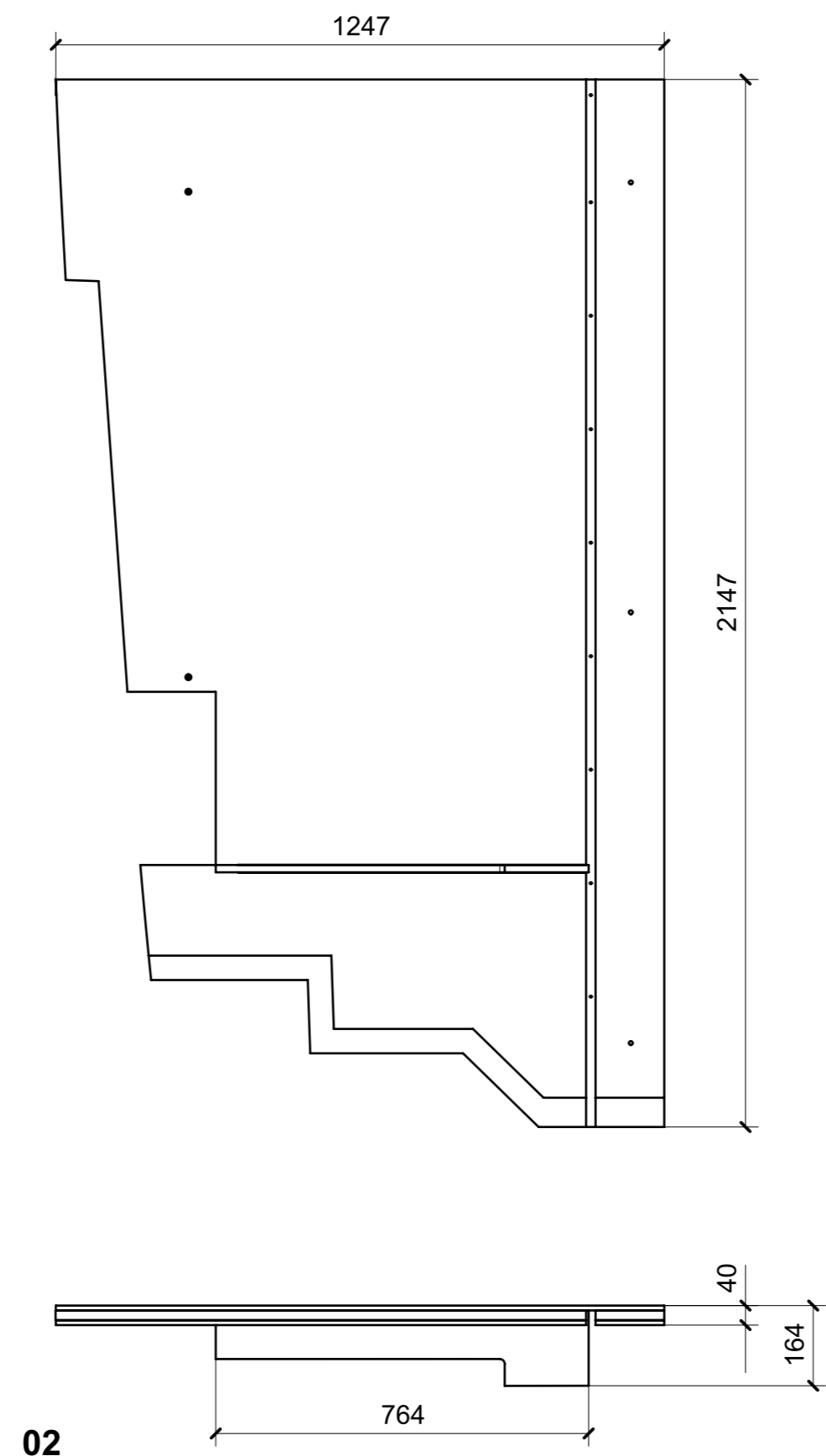
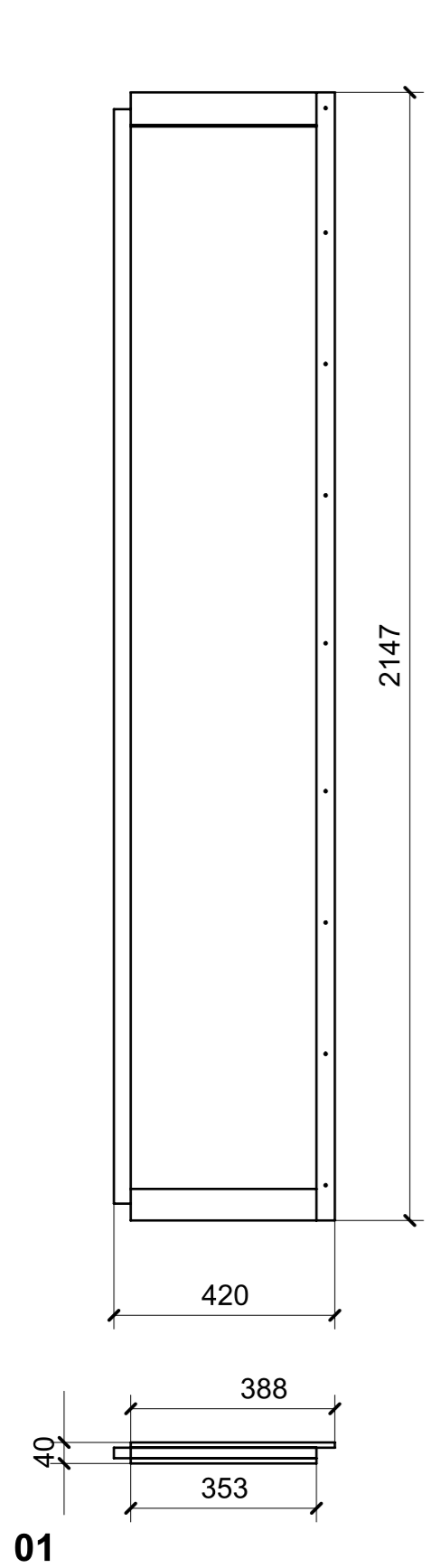

FERRAMENTA	QTY
BUSSOLA 6MA X 10 FORO DIAM.8	4

LOCALE	CODICE	DESCRIZIONE COMPONENTE	FINITURA	GR.
PARATIE LD	MD320_PR17	PARATIA PORTA BAGNO VIP SX	OKUME' GREZZO	2

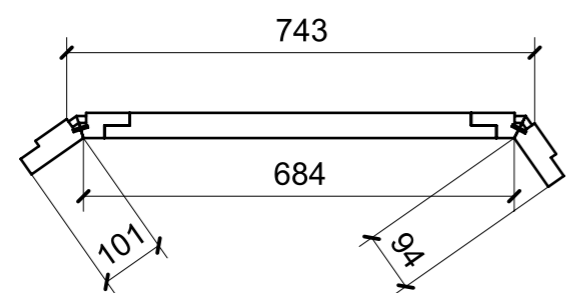
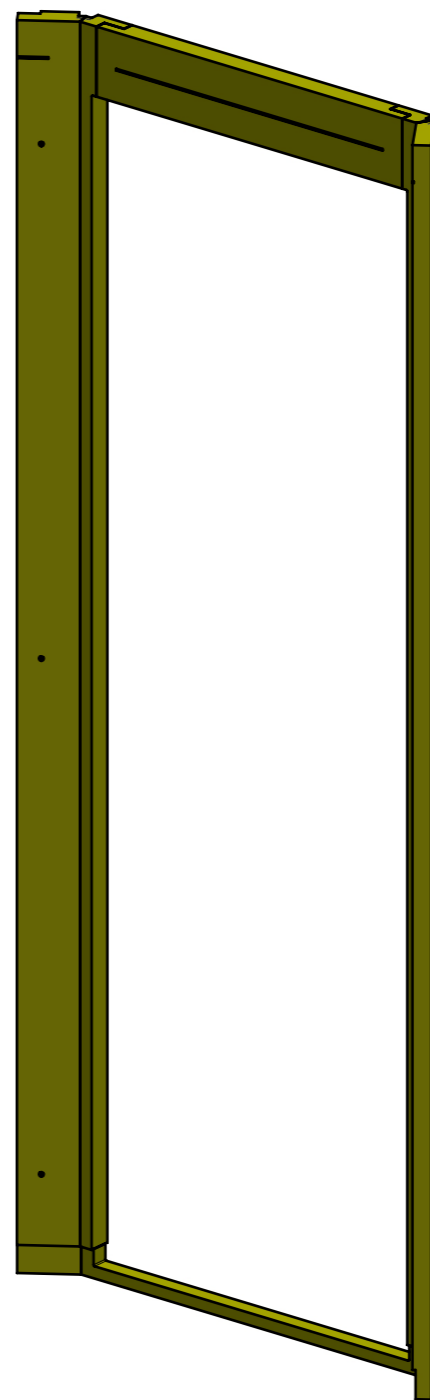
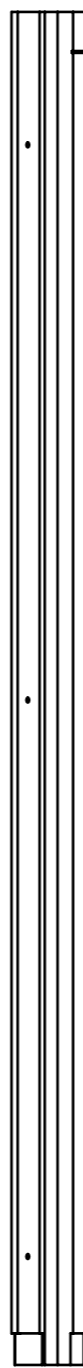
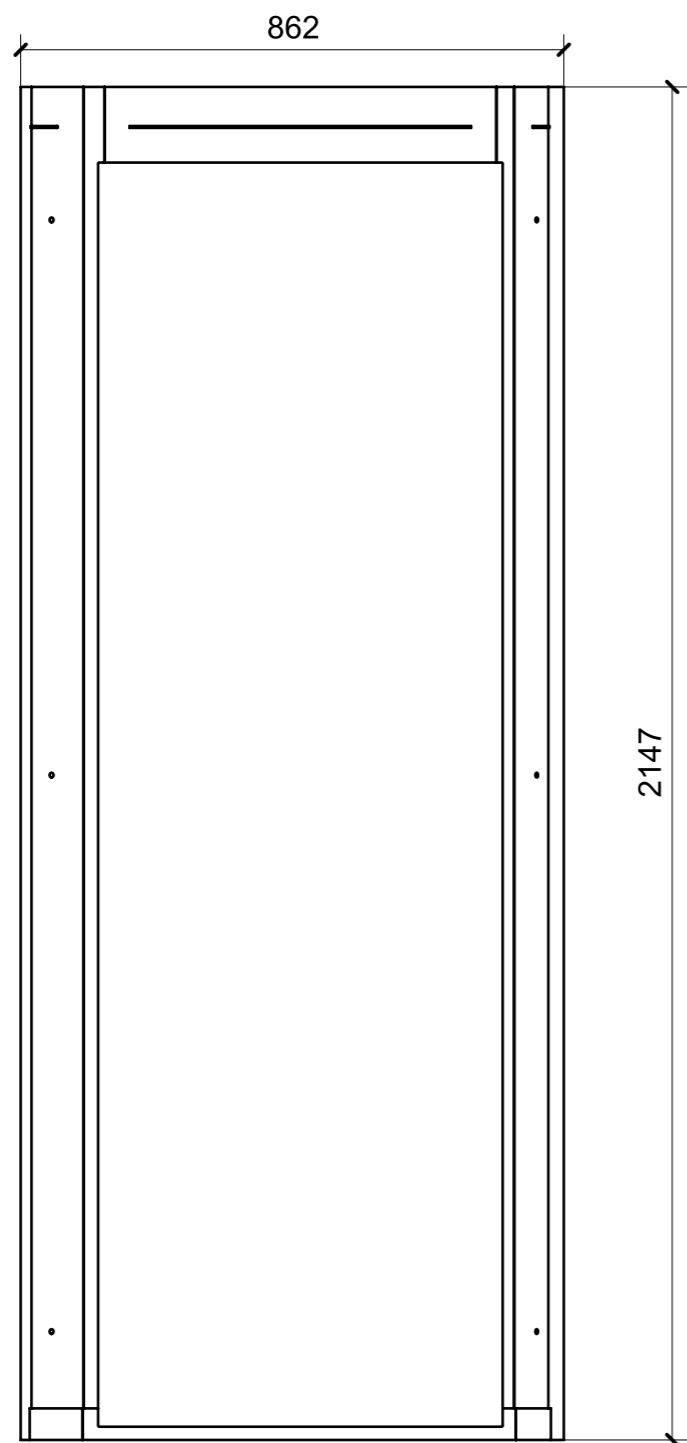

01

LOCALE	CODICE	DESCRIZIONE COMPONENTE	FINITURA	GR.
PARATIE LD	MD320_PR18	PARATIA BAGNO VIP SX CENTRO NAVE	LARICROSS/ GREZZO	2

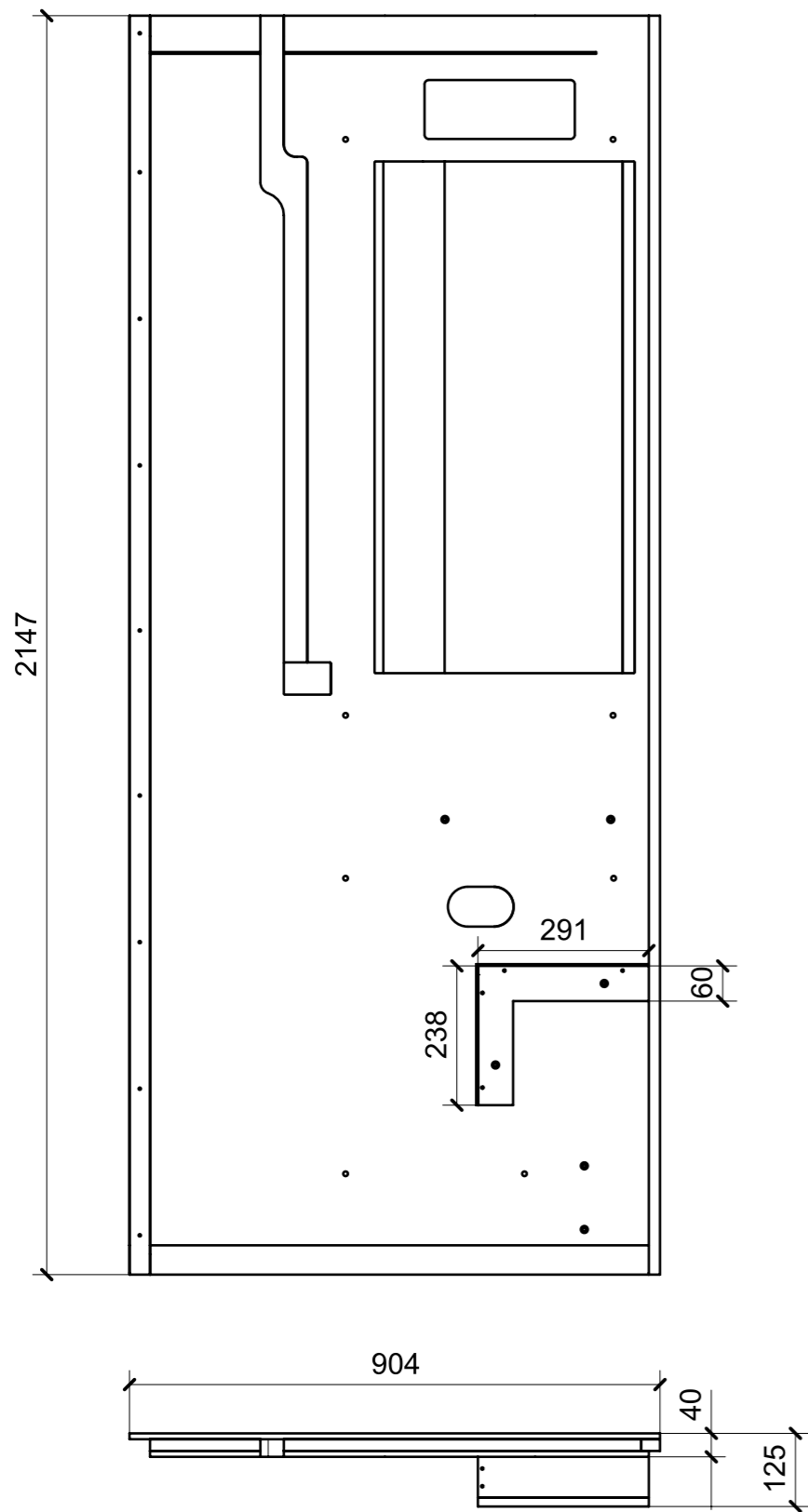

01

GREZZO
SPRUZZATO NERO

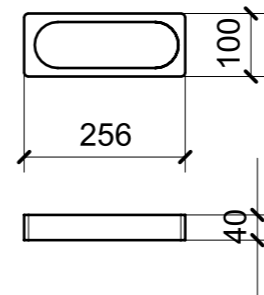

02

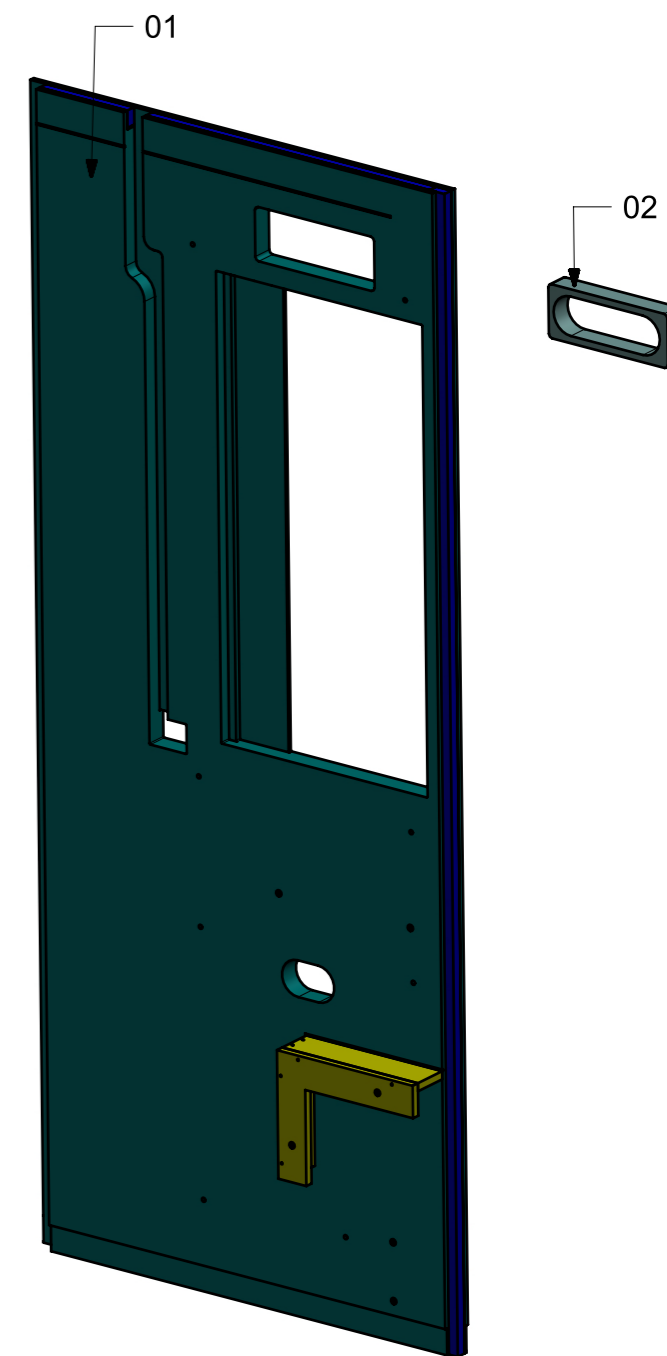

FERRAMENTA	QTY
BUSSOLA 6MA X 10 FORO DIAM.8	8

LOCALE	CODICE	DESCRIZIONE COMPONENTE	FINITURA	GR.
PARATIE LD	MD320_PR19	PARATIA BAGNO VIP SX PORTA DOCCIA	OKUME' GREZZO	PTP

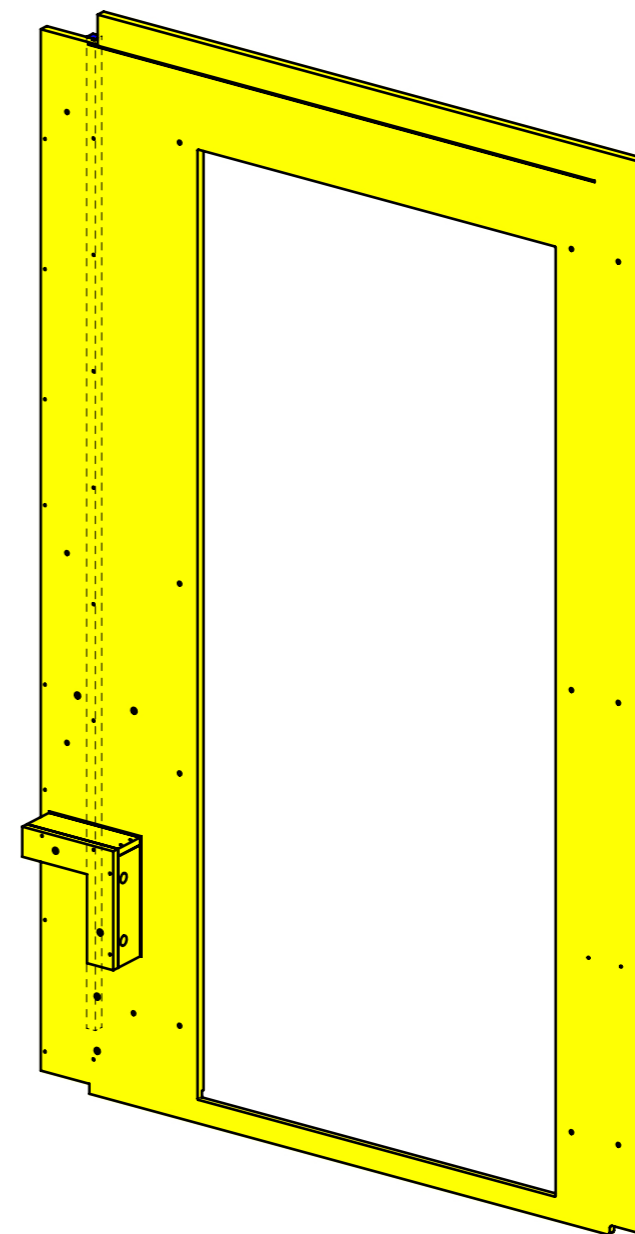
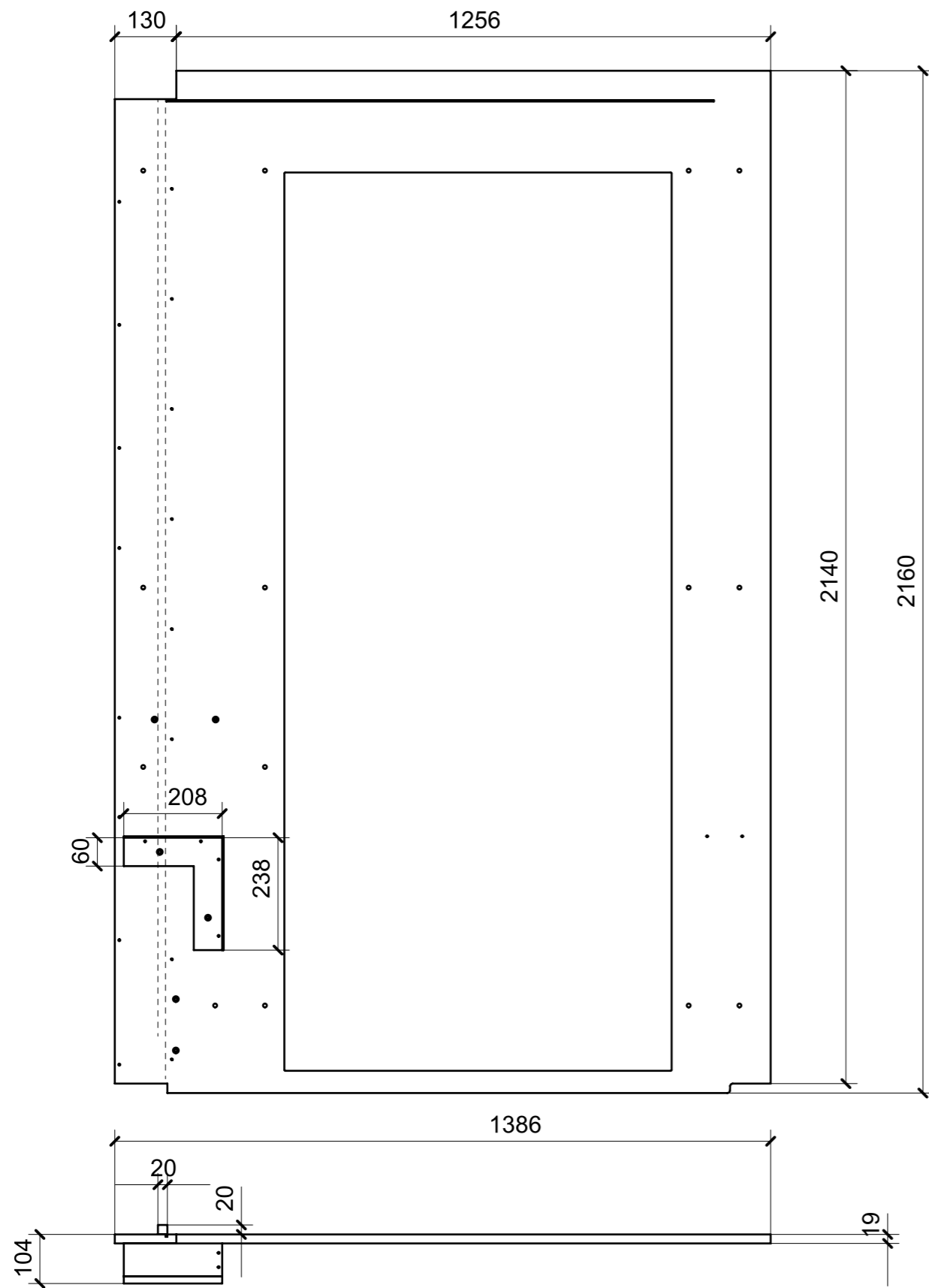

FERRAMENTA	QTY
BUSSOLA 6MA X 10 FORO DIAM.8	6

01

LOCALE	CODICE	DESCRIZIONE COMPONENTE	FINITURA	GR.
PARATIE LD	MD320_PR20	PARATIA BAGNO VIP SX POPPA MURATA	OKUME' GREZZO	2

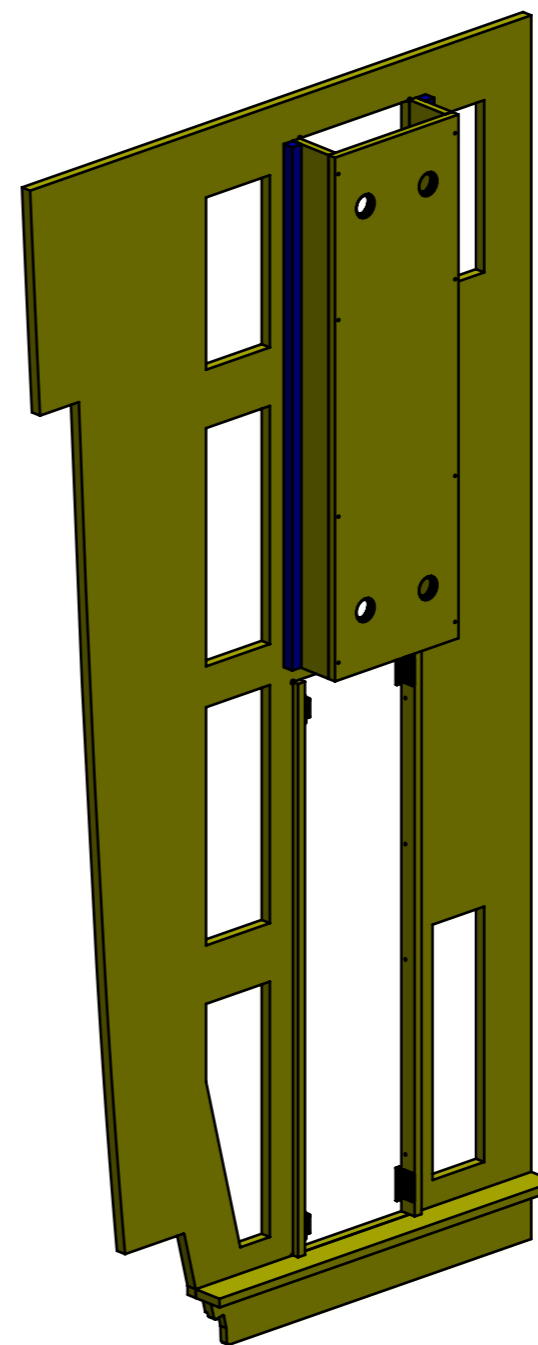
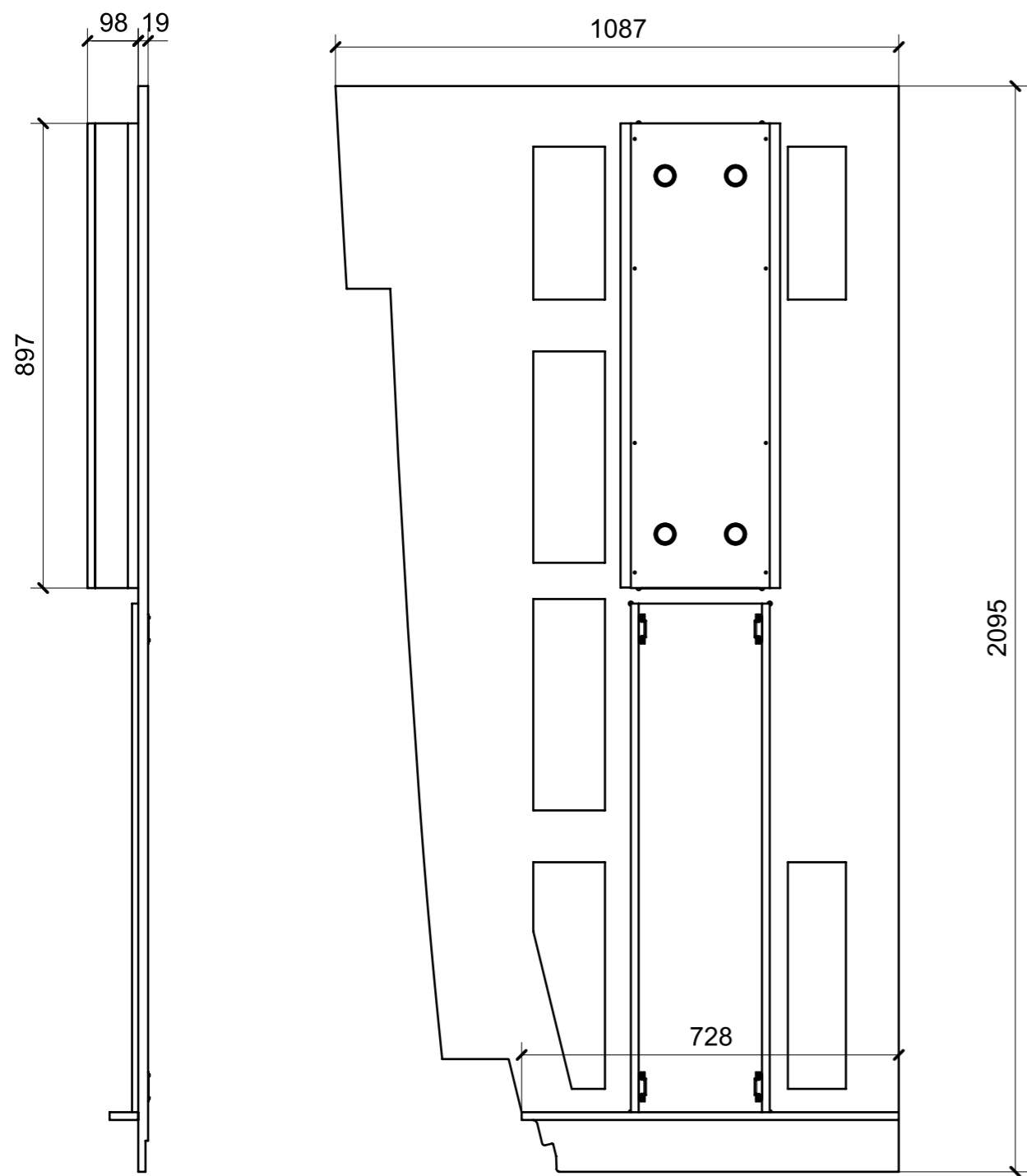

01

FERRAMENTA	QTY
BUSSOLA 6MA X 10 FORO DIAM.8	3
CHIUSURA A SPINTA_TECHNOPARTNER_SOU C3-203	4
FITLOCK F_MASCHERPA_6020101102	4

LOCALE	CODICE	DESCRIZIONE COMPONENTE	FINITURA	GR.
PARATIE LD	MD320_PR21	PARATIA BAGNO VIP SX POPPA LAVABO	CARTA MELAMINICA NERA /OKUME' GREZZO	2

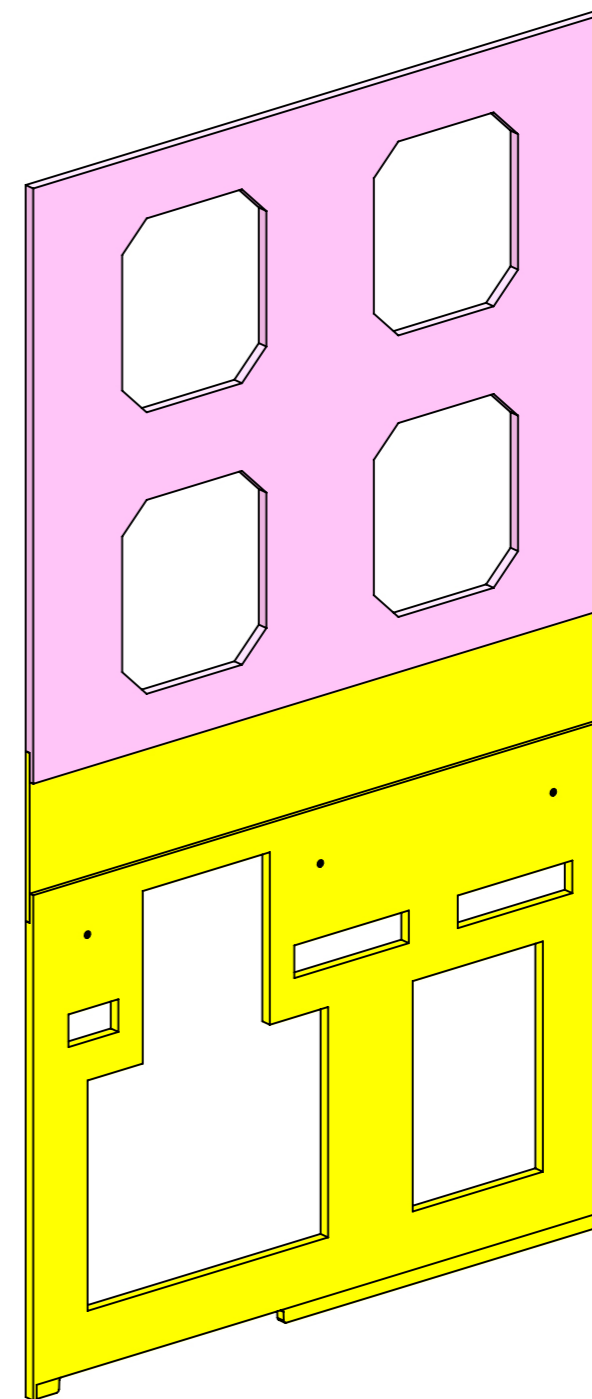
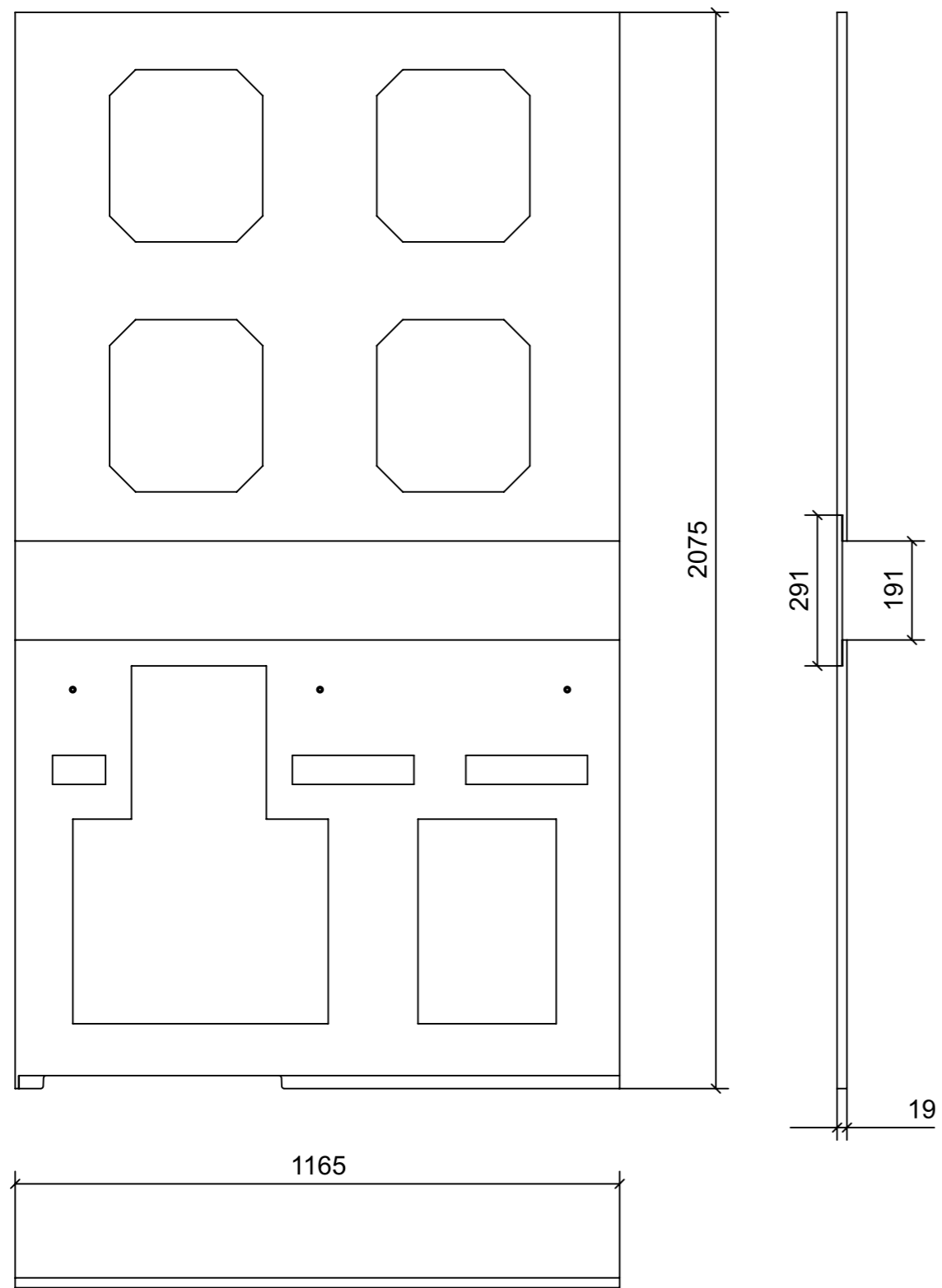

01

FERRAMENTA	QTY
BUSSOLA 6MA X 10 FORO DIAM.8	3

LOCALE	CODICE	DESCRIZIONE COMPONENTE	FINITURA	GR.
PARATIE LD	MD320_PR22	PARATIA CABINA VIP DX_SX POPPA	OKUME' GREZZO	PTP

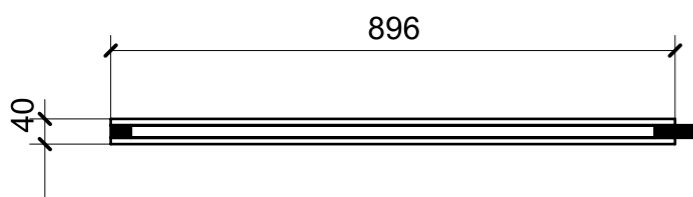
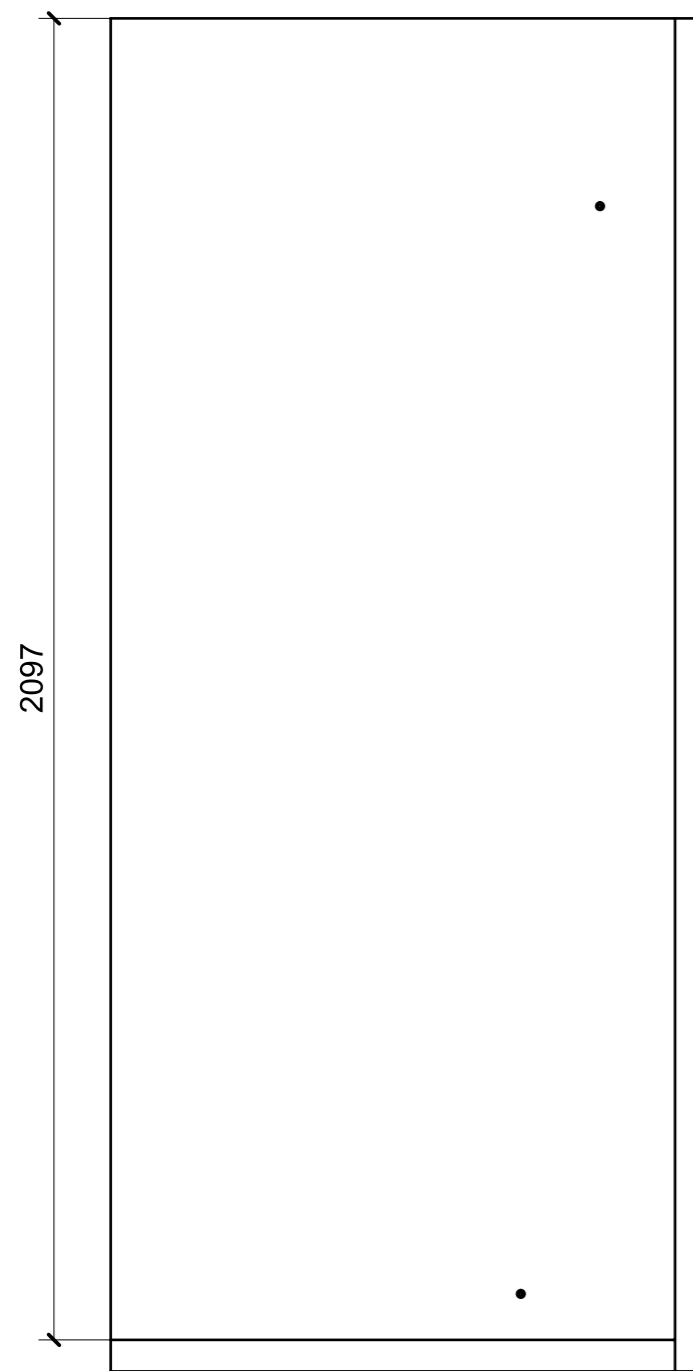

01

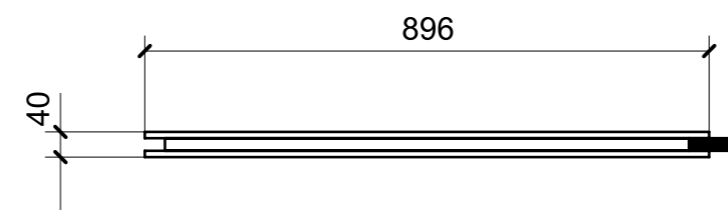
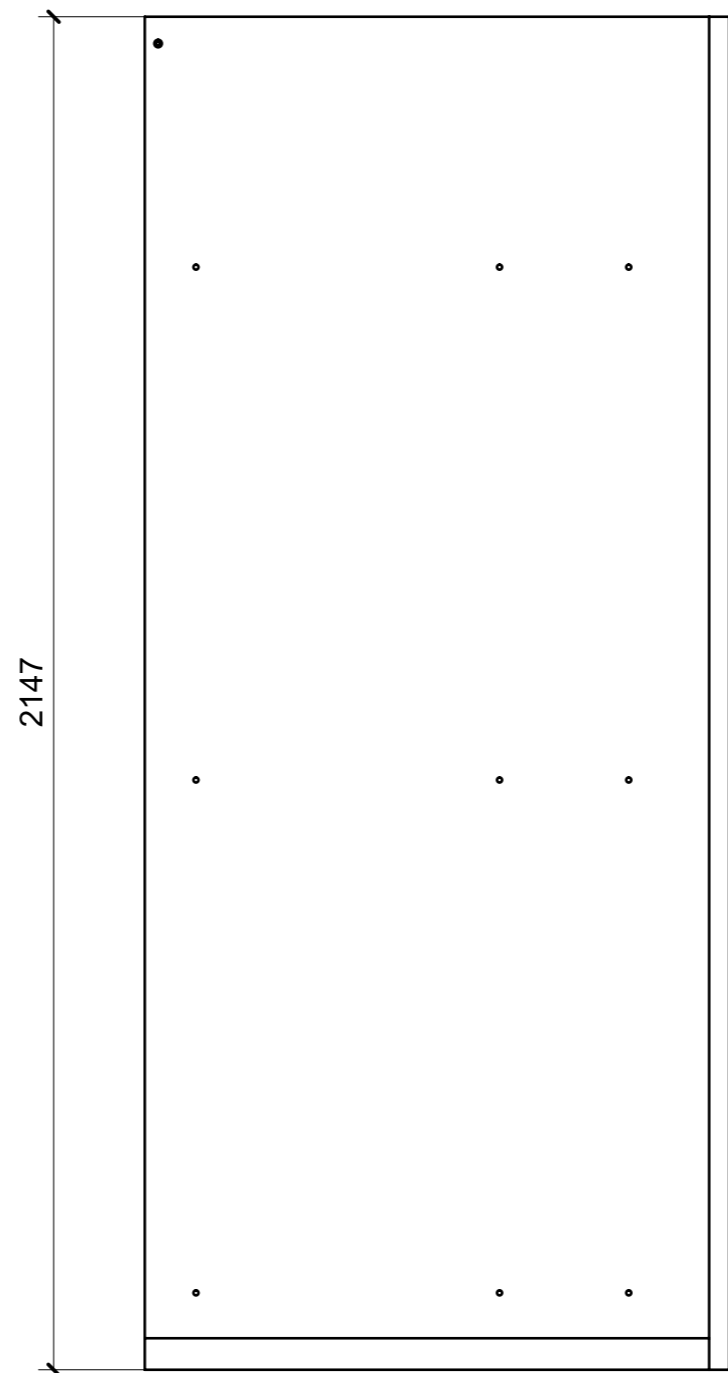

02

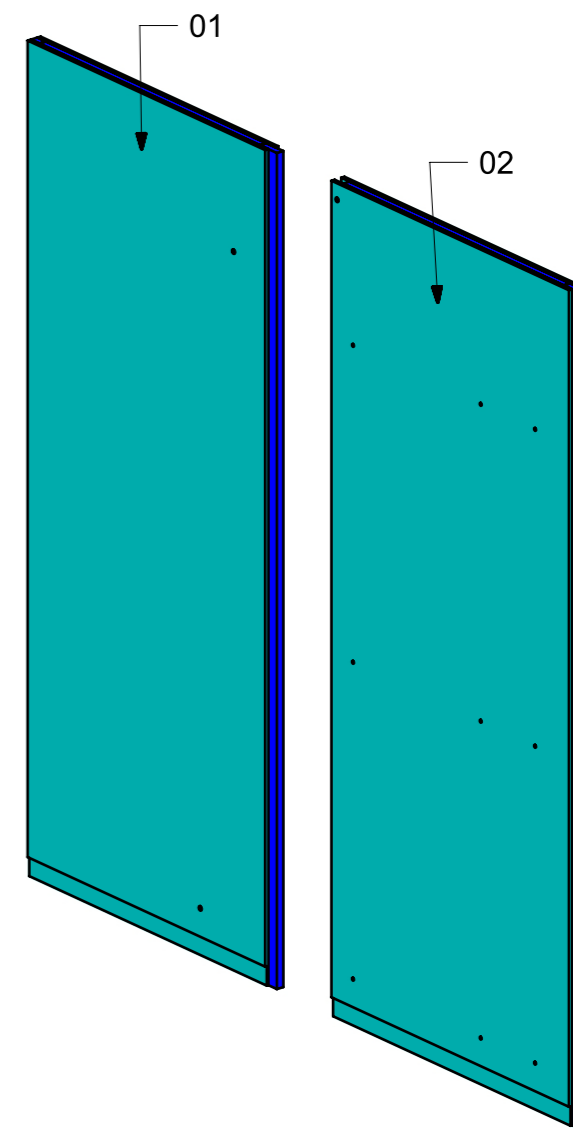

FERRAMENTA	QTY
BUSSOLA 6MA X 10 FORO DIAM.8	6

LOCALE	CODICE	DESCRIZIONE COMPONENTE	FINITURA	GR.
PARATIE LD	MD320_PR23	PARATIA CABINA VIP DX_SX PRUA	LARICROSS / OKUME'	2

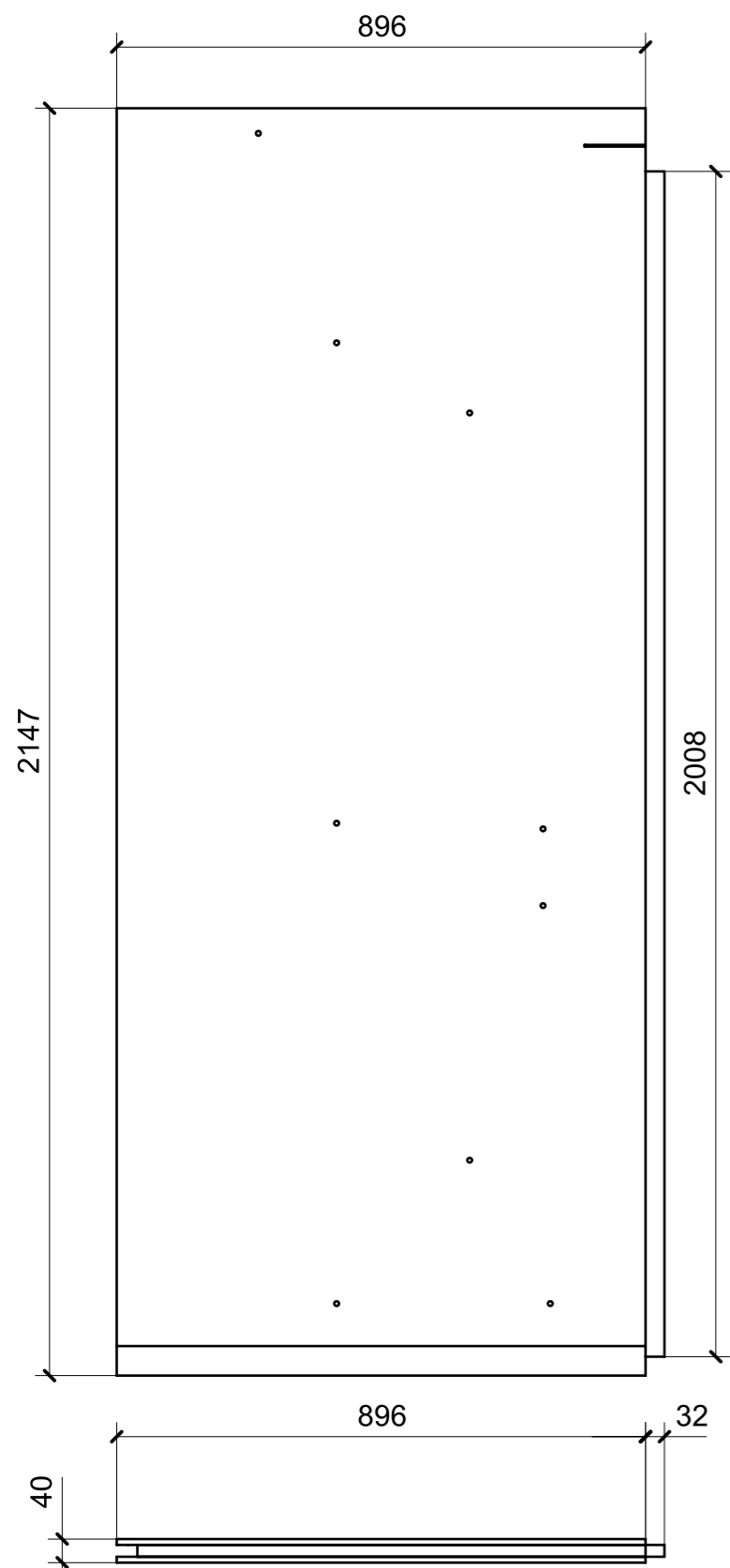

01

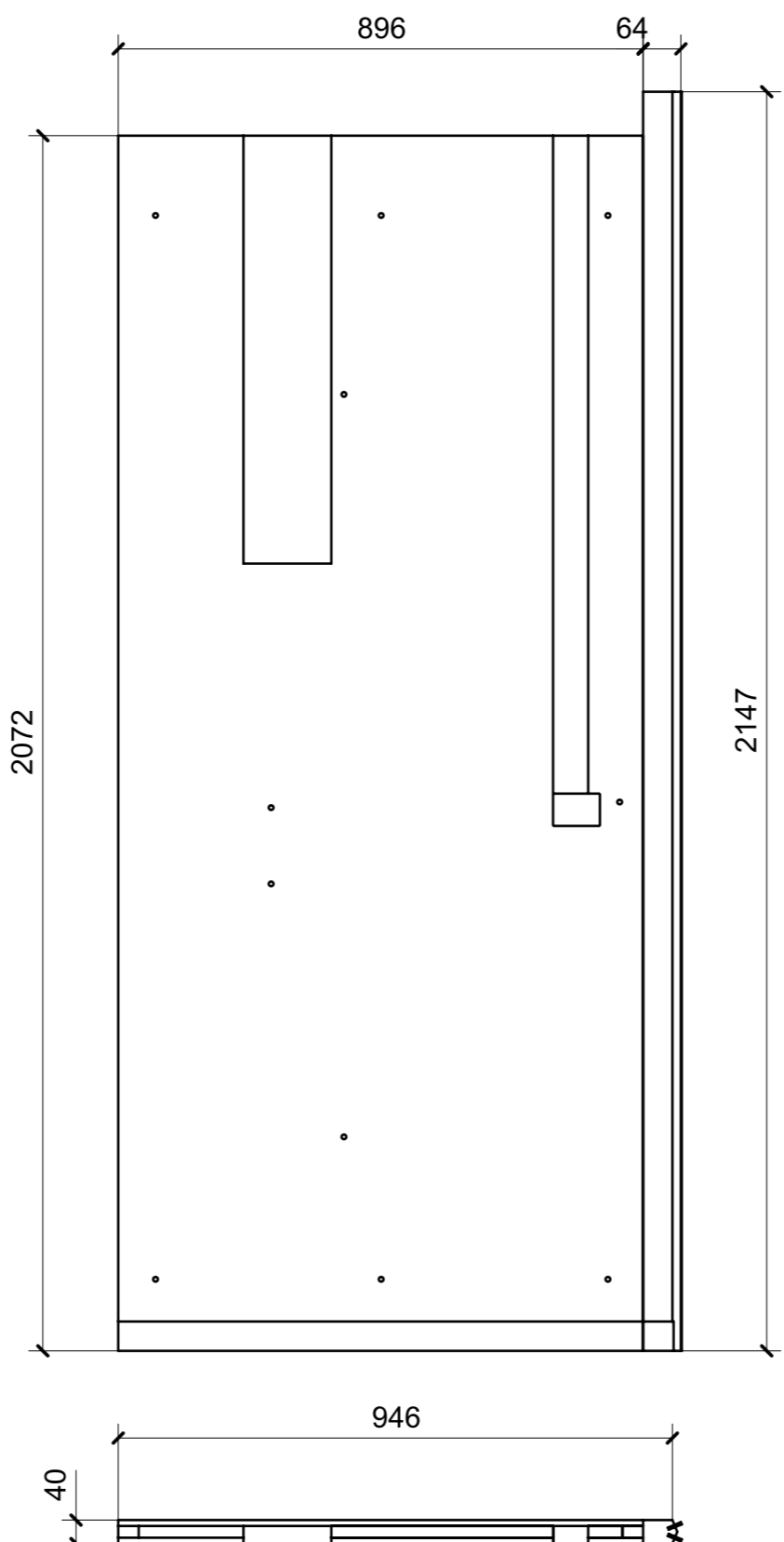

02

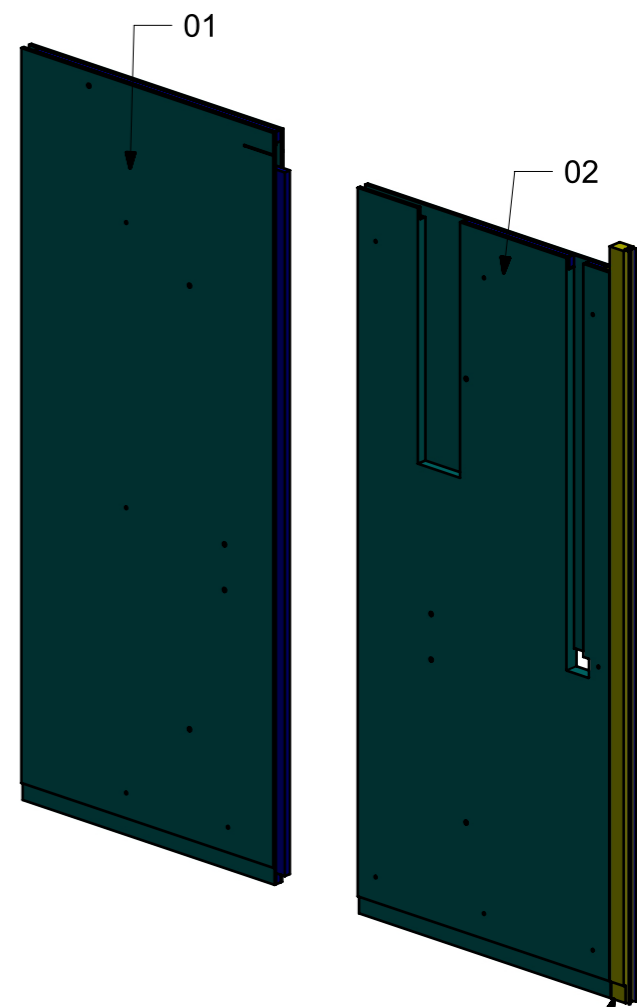

OKUME' GREZZO

FERRAMENTA	QTY
BUSSOLA 6MA X 10 FORO DIAM.8	18

LOCALE	CODICE	DESCRIZIONE COMPONENTE	FINITURA	GR.
PARATIE LD	MD320_PR24	PARATIA PORTA CABINA VIP DX	OKUME' GREZZO	2

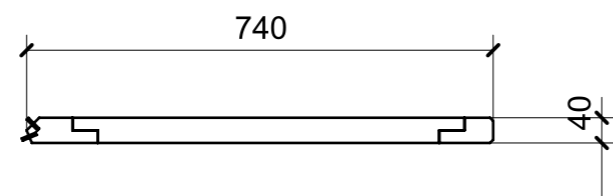
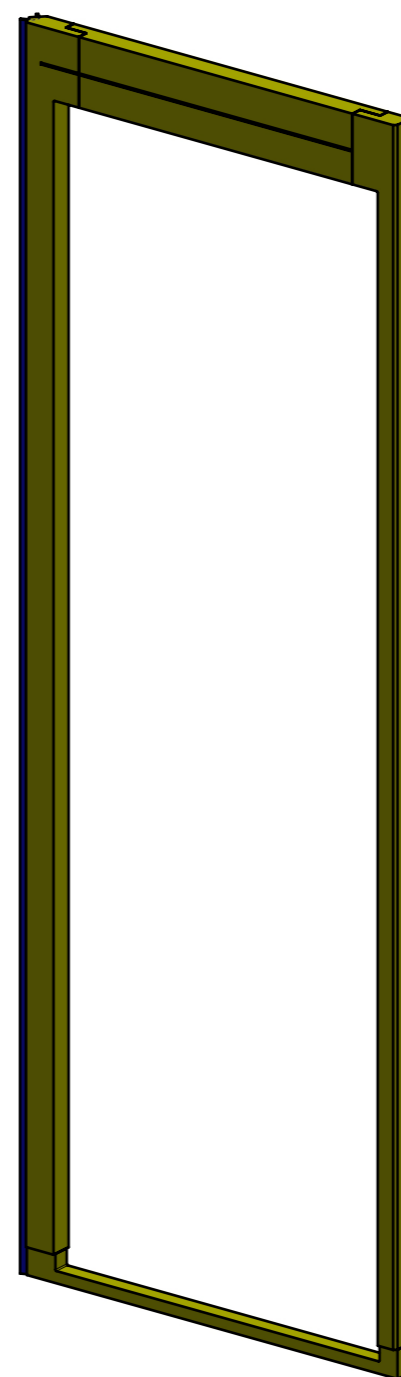
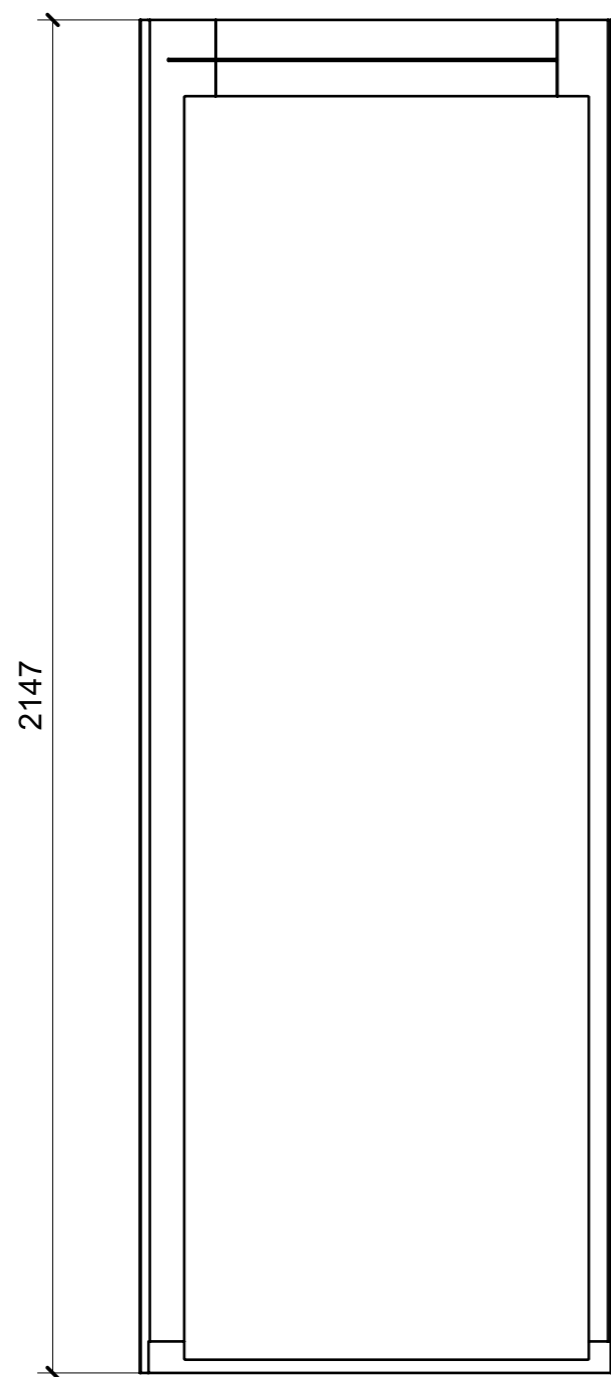

01

LOCALE	CODICE	DESCRIZIONE COMPONENTE	FINITURA	GR.
PARATIE LD	MD320_PR25	PARATIA PORTA CABINA VIP SX	OKUME' GREZZO	PTP

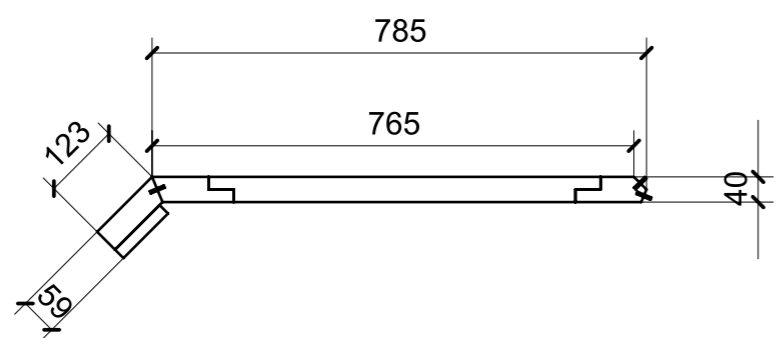
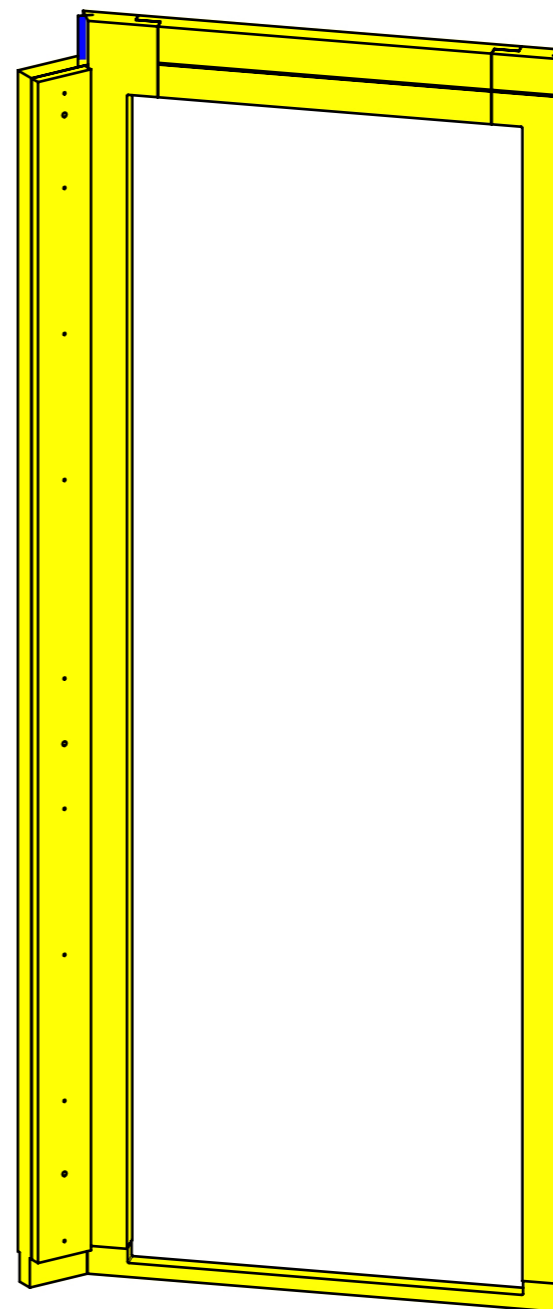
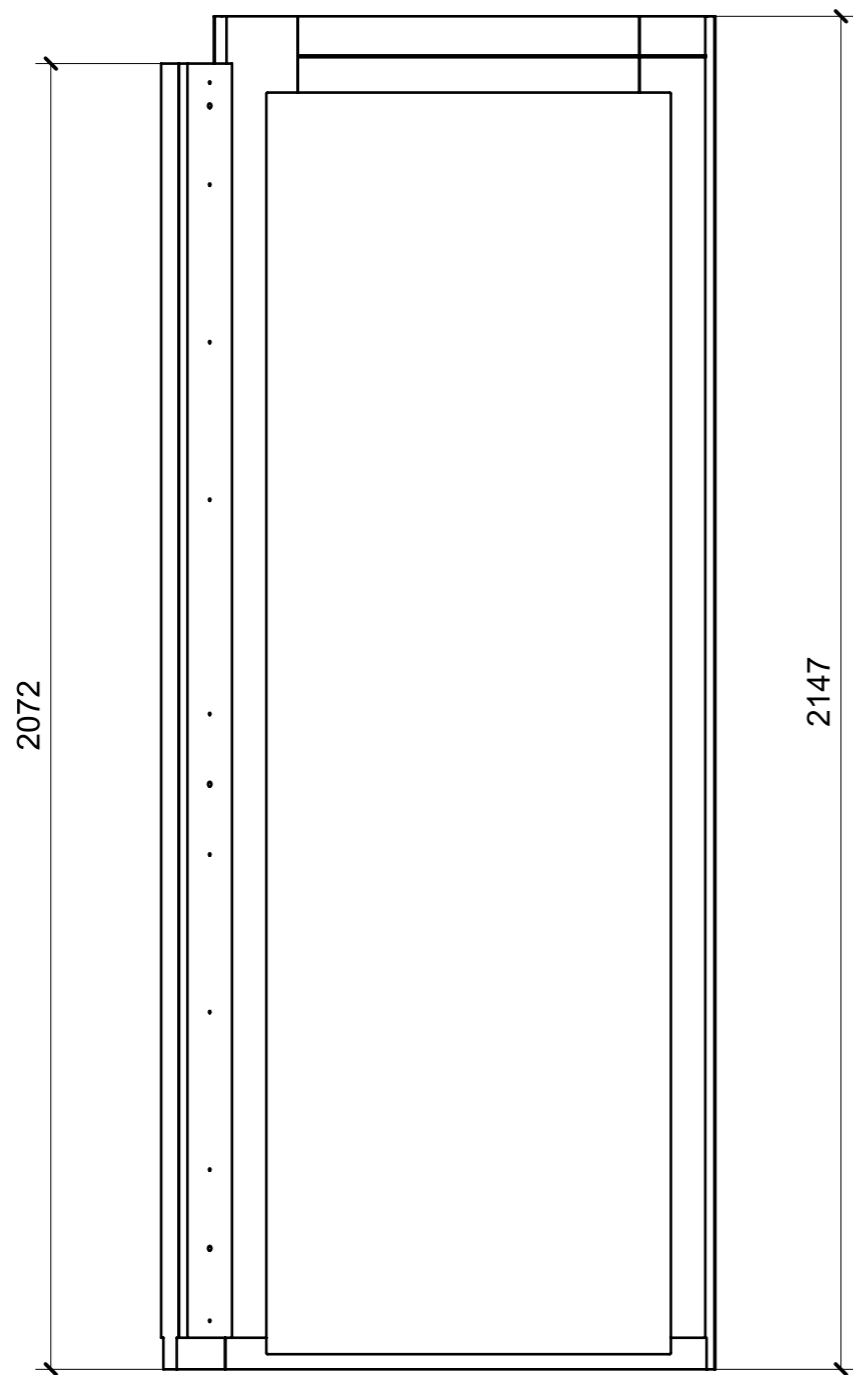

01

LOCALE	CODICE	DESCRIZIONE COMPONENTE	FINITURA	GR.
PARATIE LD	MD320_PR26	PARATIA STRUTTURALE DX	OKUME' GREZZO	PTP

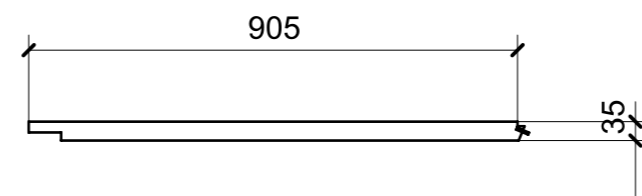
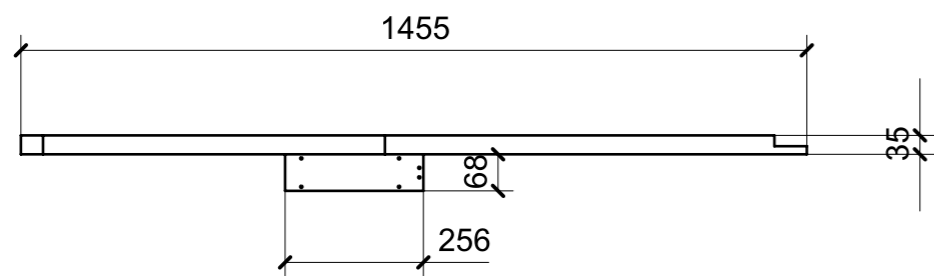
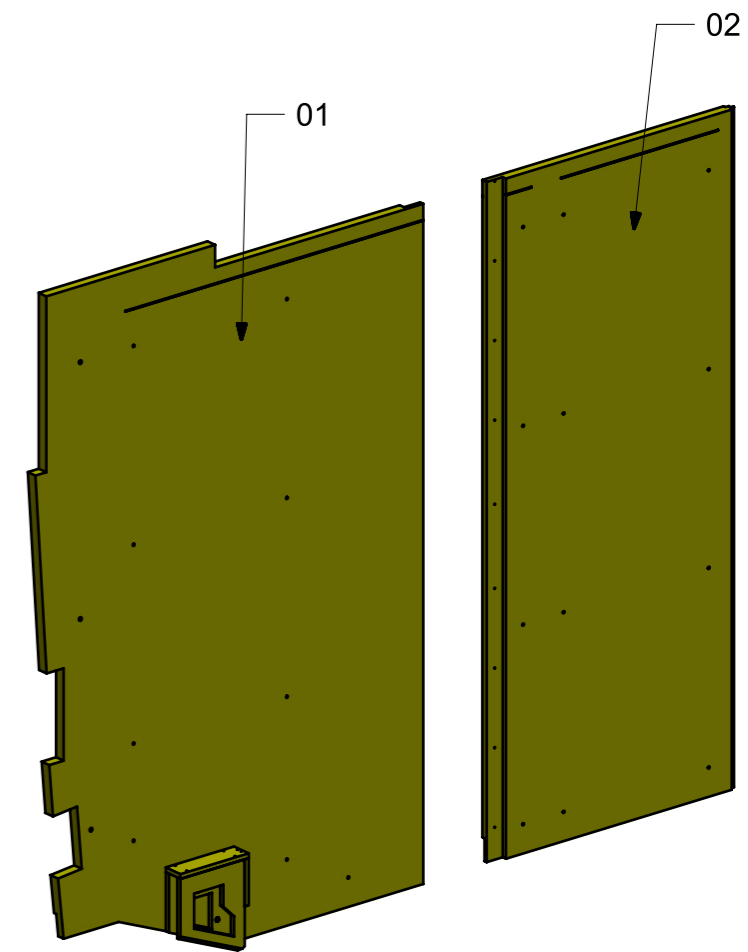
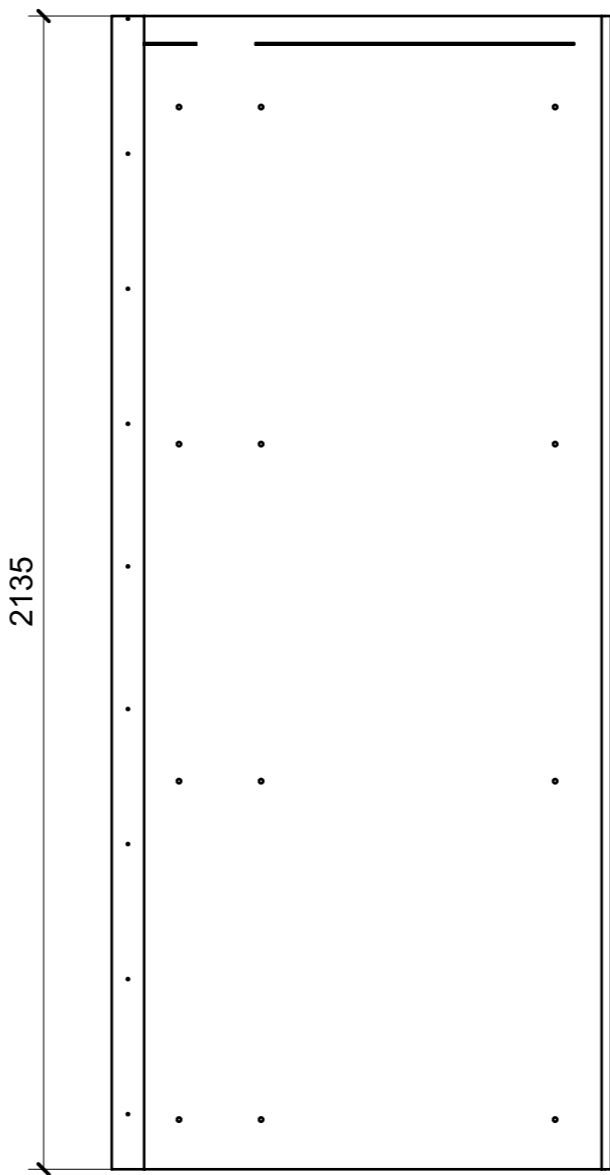
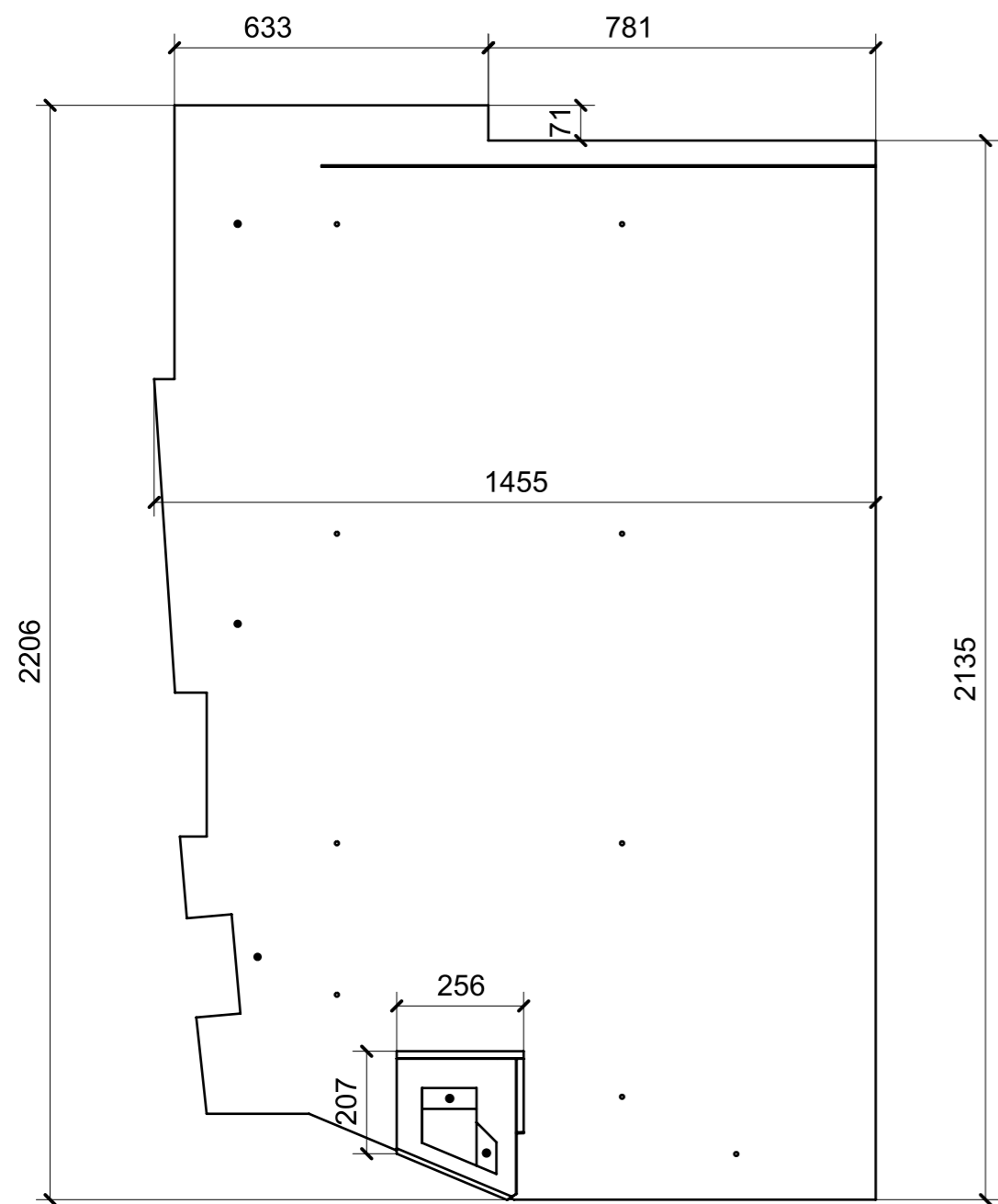

01

02

FERRAMENTA	QTY
VITE 6MA X 25 TESTA BOMBATA	2
BUSSOLA 6MA X 10 FORO DIAM.8	7

LOCALE	CODICE	DESCRIZIONE COMPONENTE	FINITURA	GR.
PARATIE LD	MD320_PR27	PARATIA STRUTTURALE SX	OKUME' GREZZO	2

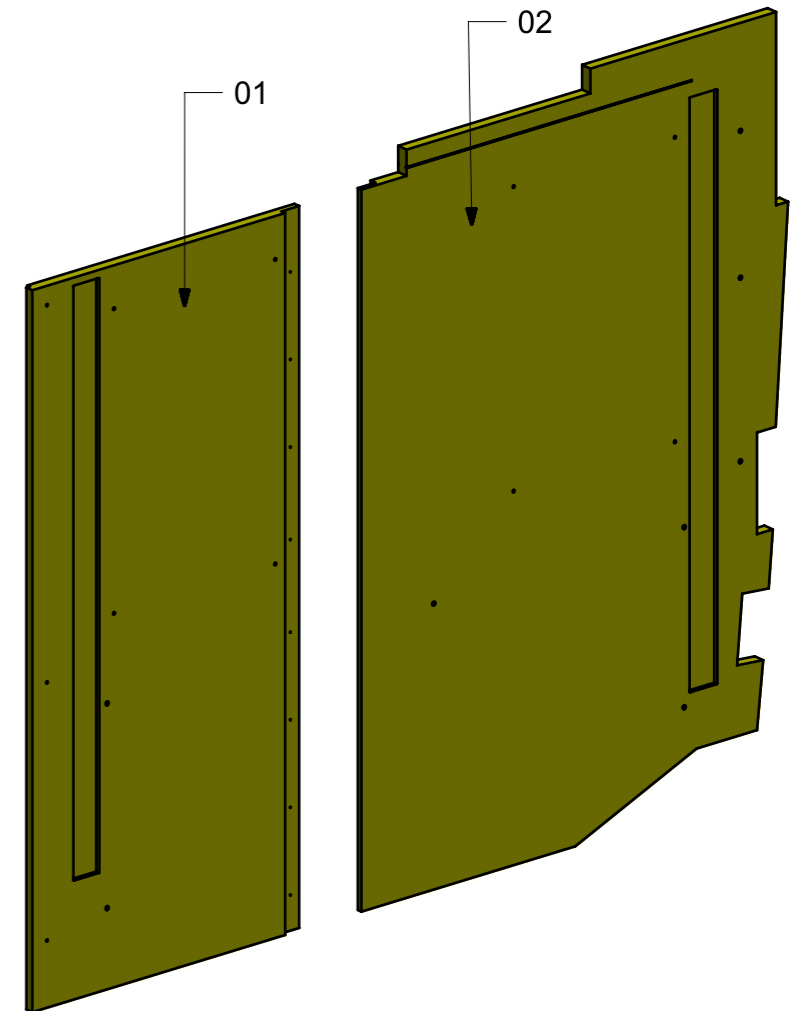
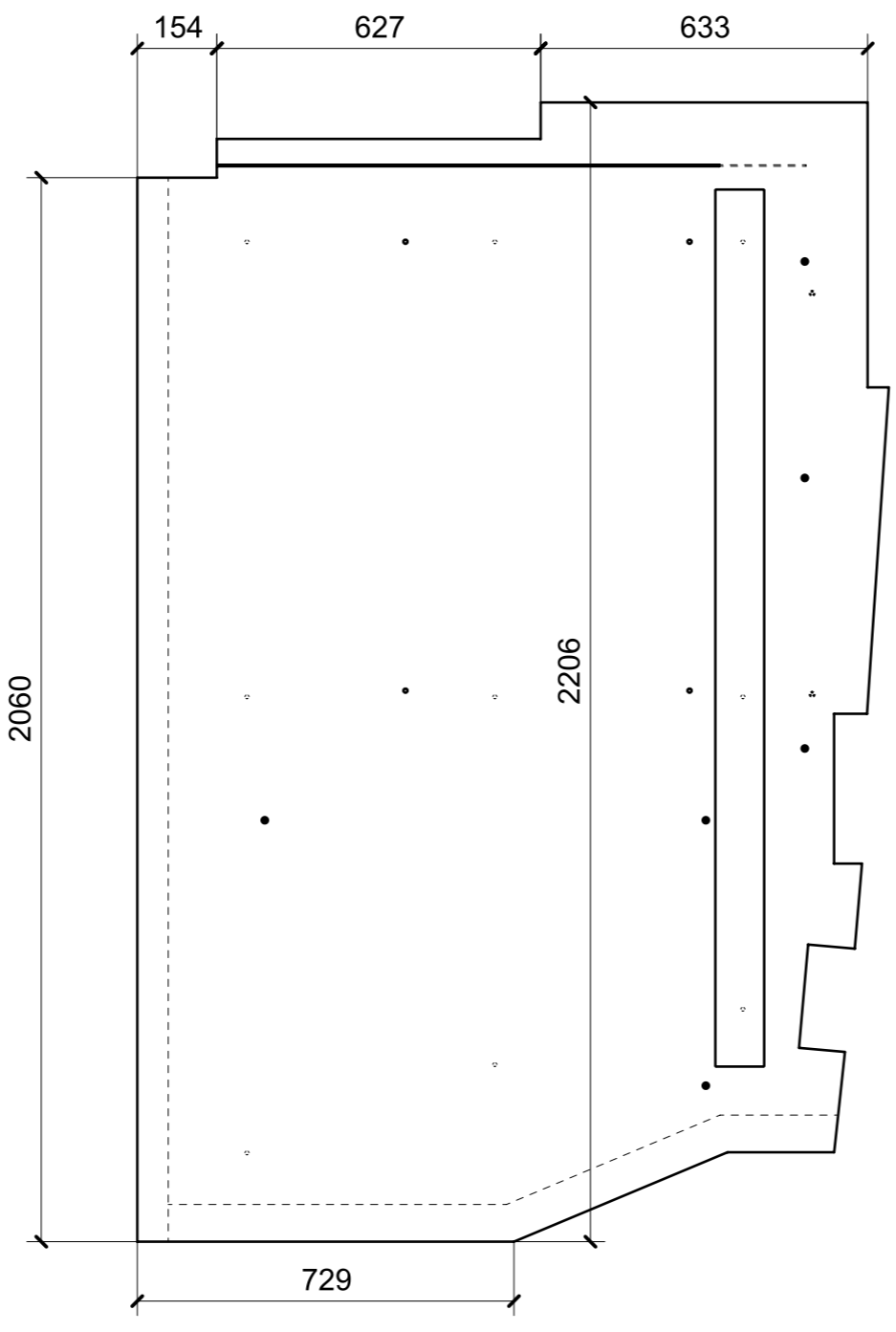
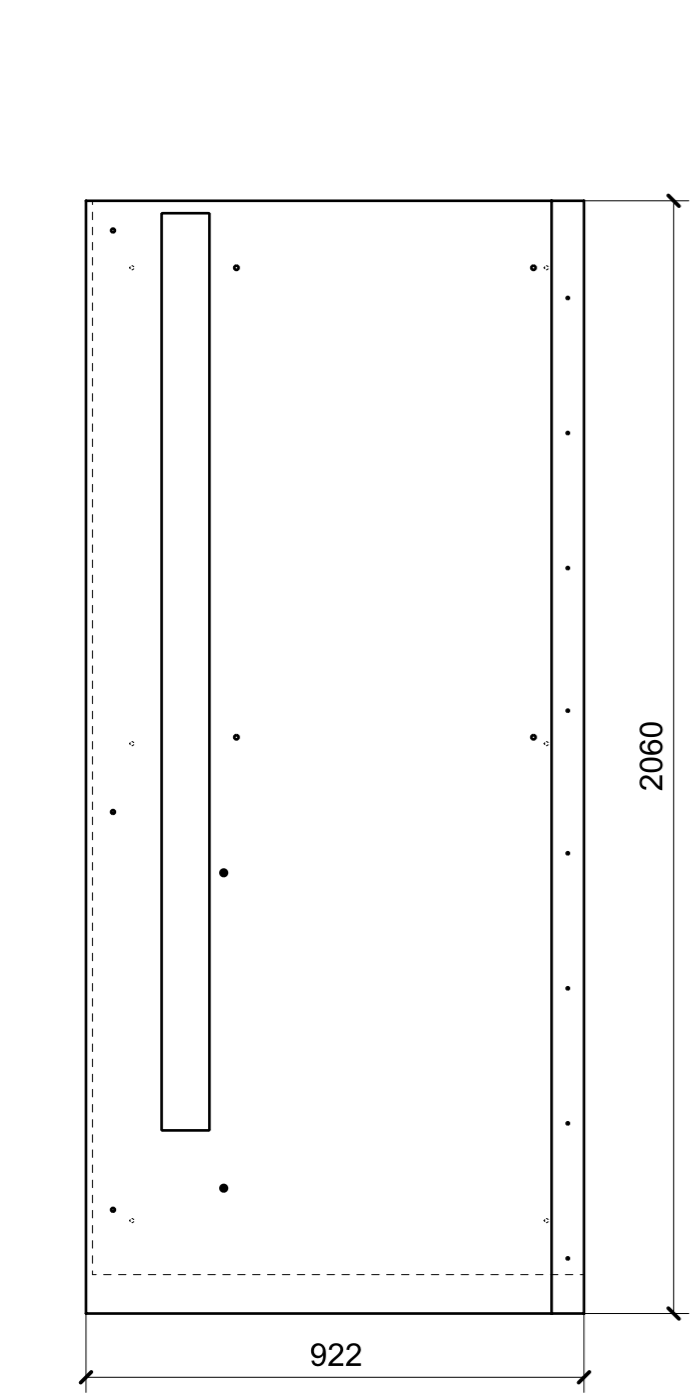

01

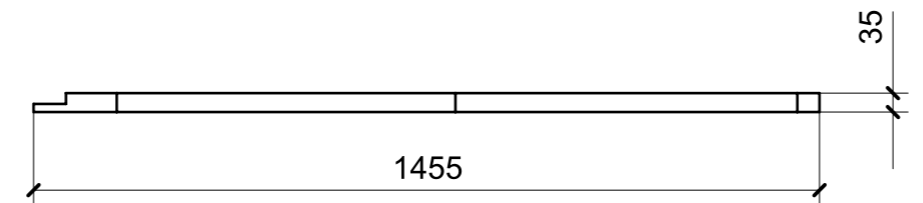

02

FERRAMENTA	QTY
BUSSOLA 6MA X 10 FORO DIAM.8	10

LOCALE	CODICE	DESCRIZIONE COMPONENTE	FINITURA	GR.
PARATIE LD	MD320_PR28	PARATIA CABINA OSPITI_LOBBY DX POPPA	LARICROSS/OKUME' GREZZO	2

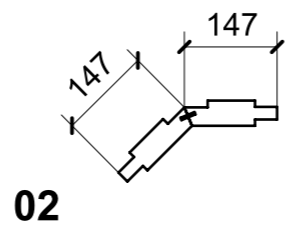
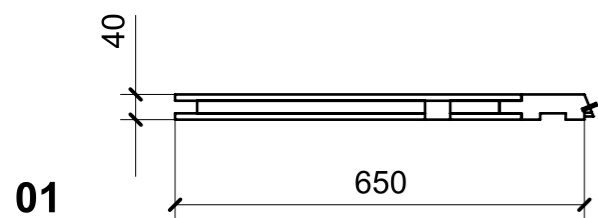
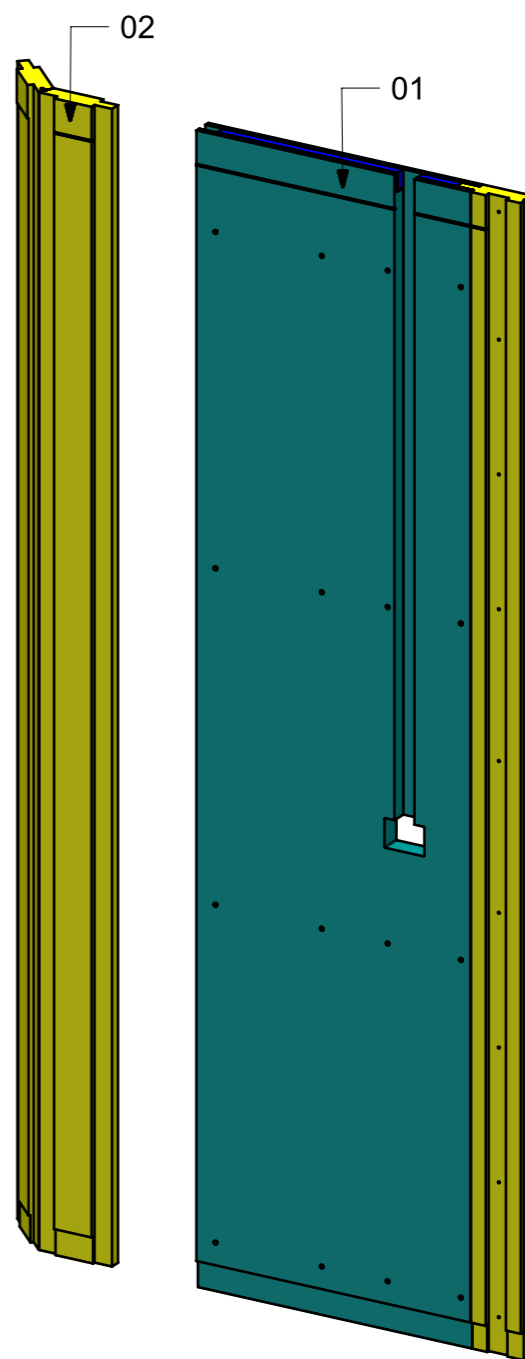
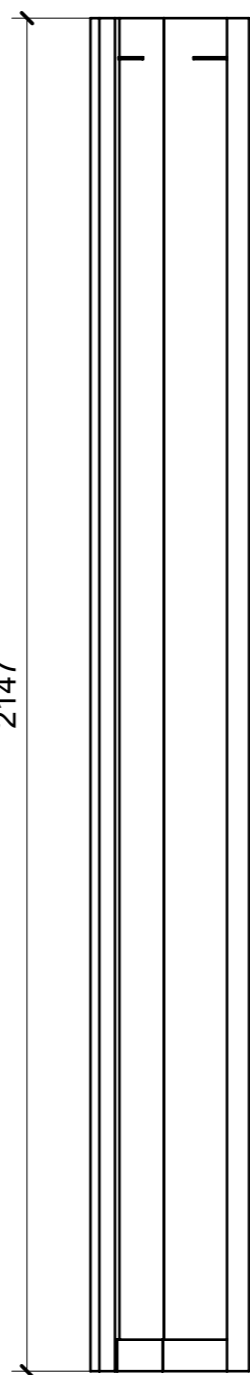
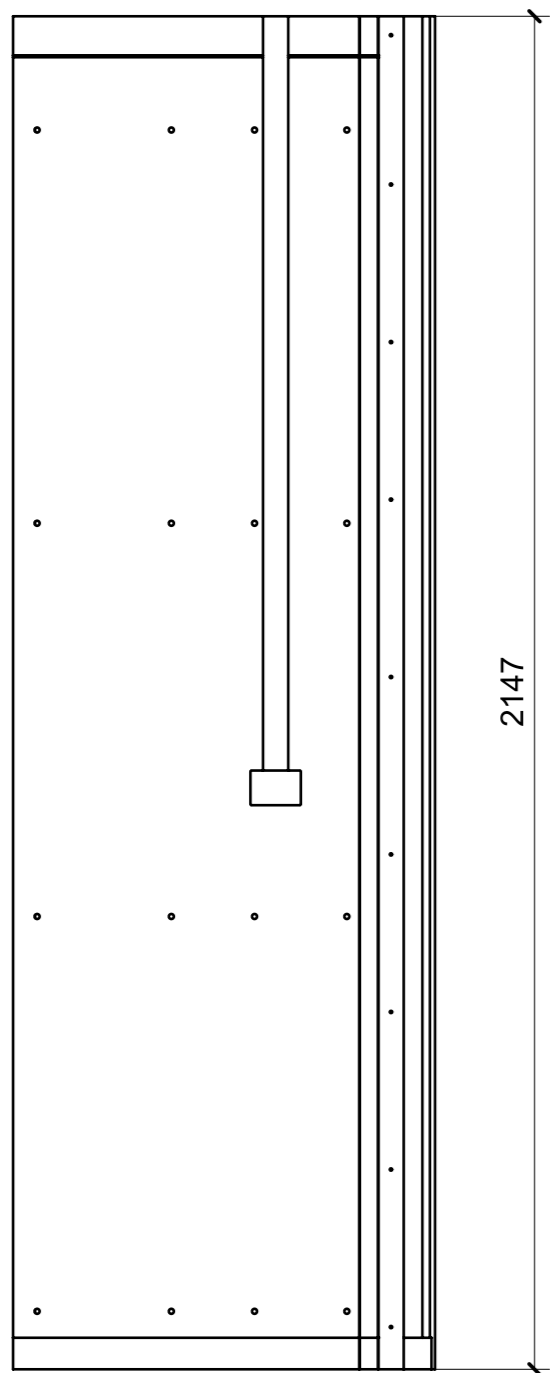

LOCALE	CODICE	DESCRIZIONE COMPONENTE	FINITURA	GR.
PARATIE LD	MD320_PR29	PARATIA TV CABINA OSPITI_LOBBY DX	LARICROSS/OKUME' GREZZO	2

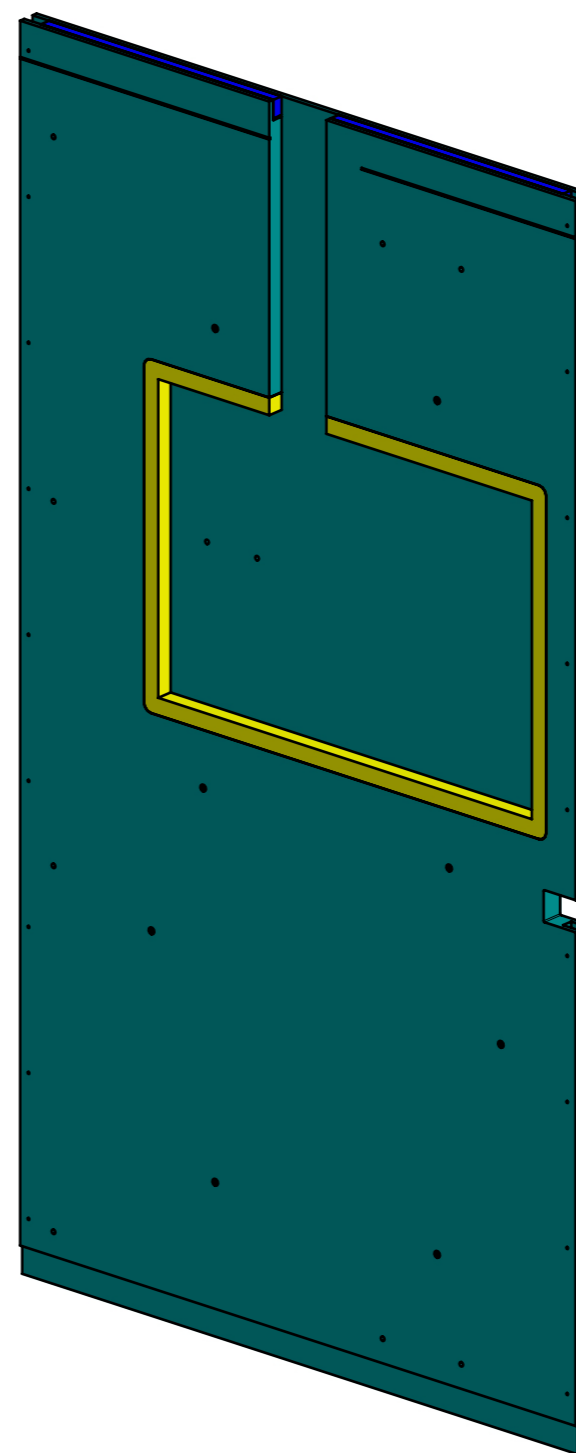
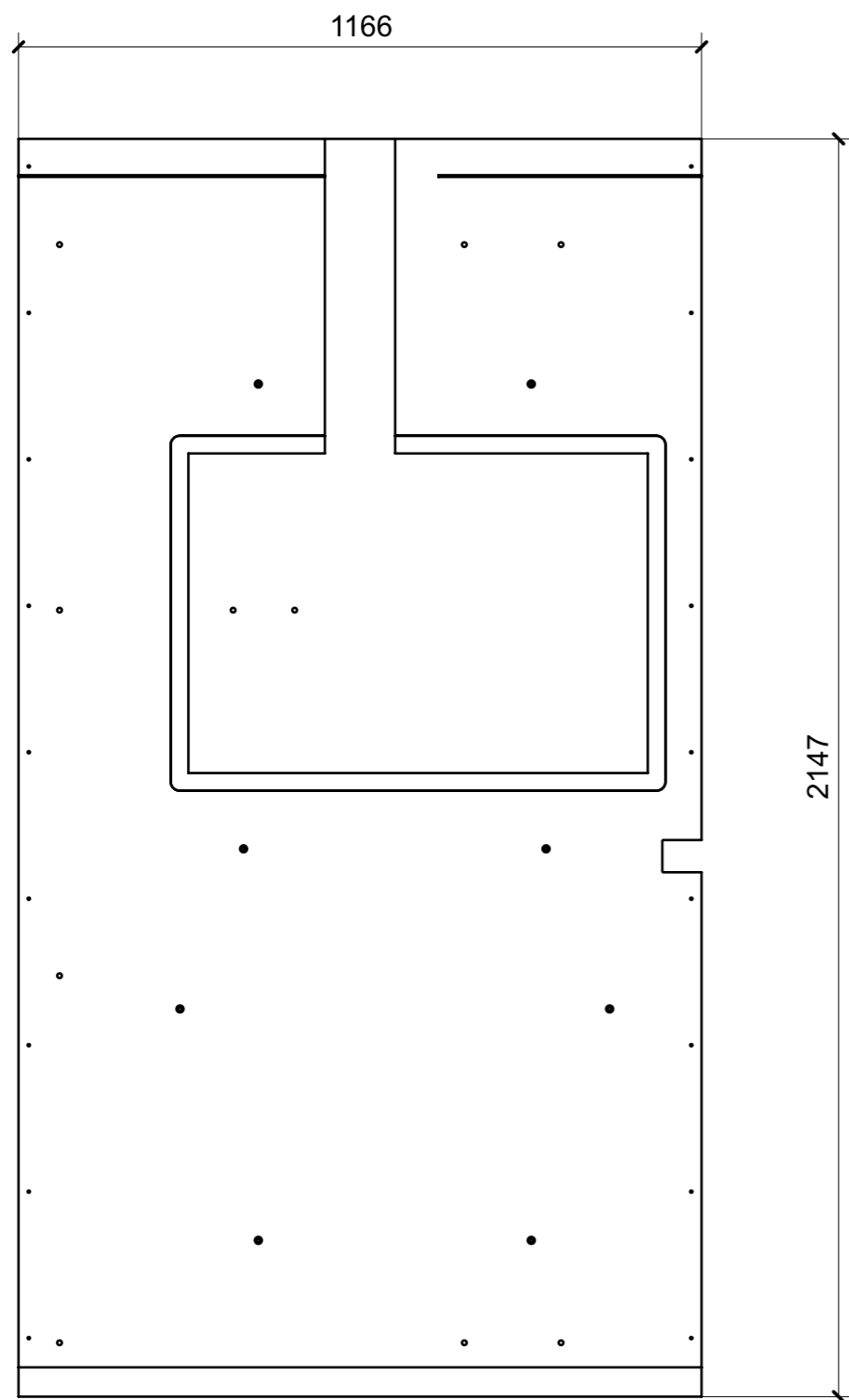

40

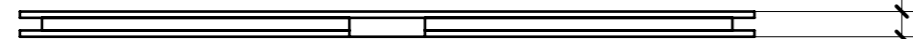

01

FERRAMENTA	QTY
BUSSOLA 6MA X 10 FORO DIAM.8	8

LOCALE	CODICE	DESCRIZIONE COMPONENTE	FINITURA	GR.
PARATIE LD	MD320_PR30	PARATIA PORTA CABINA OSPITI_LOBBY DX	OKUME' GREZZO	PTP

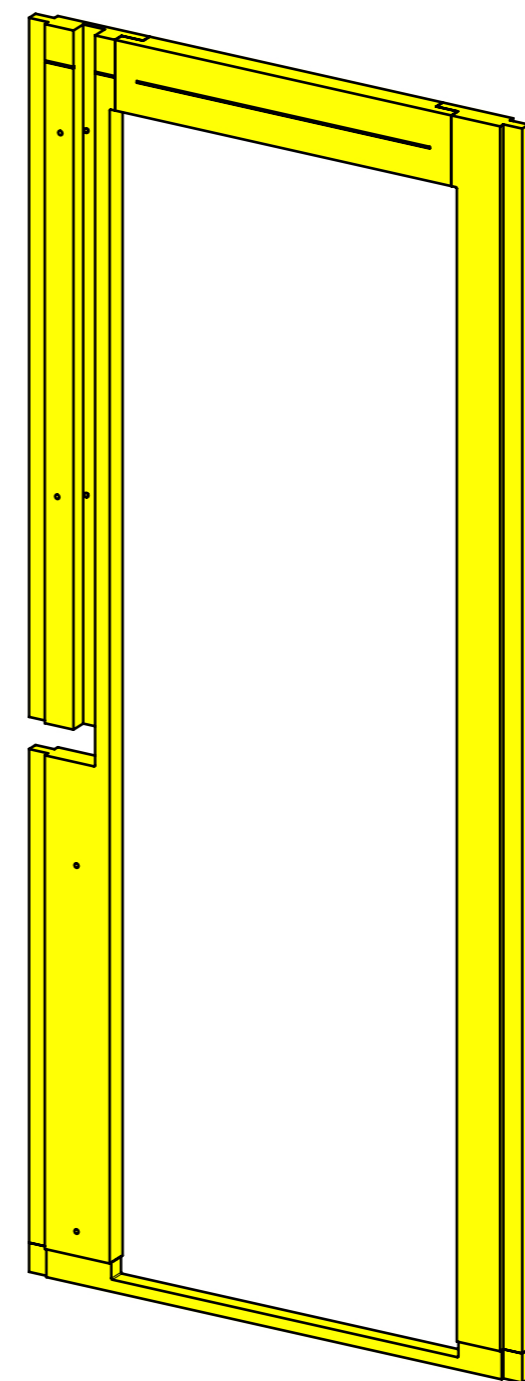
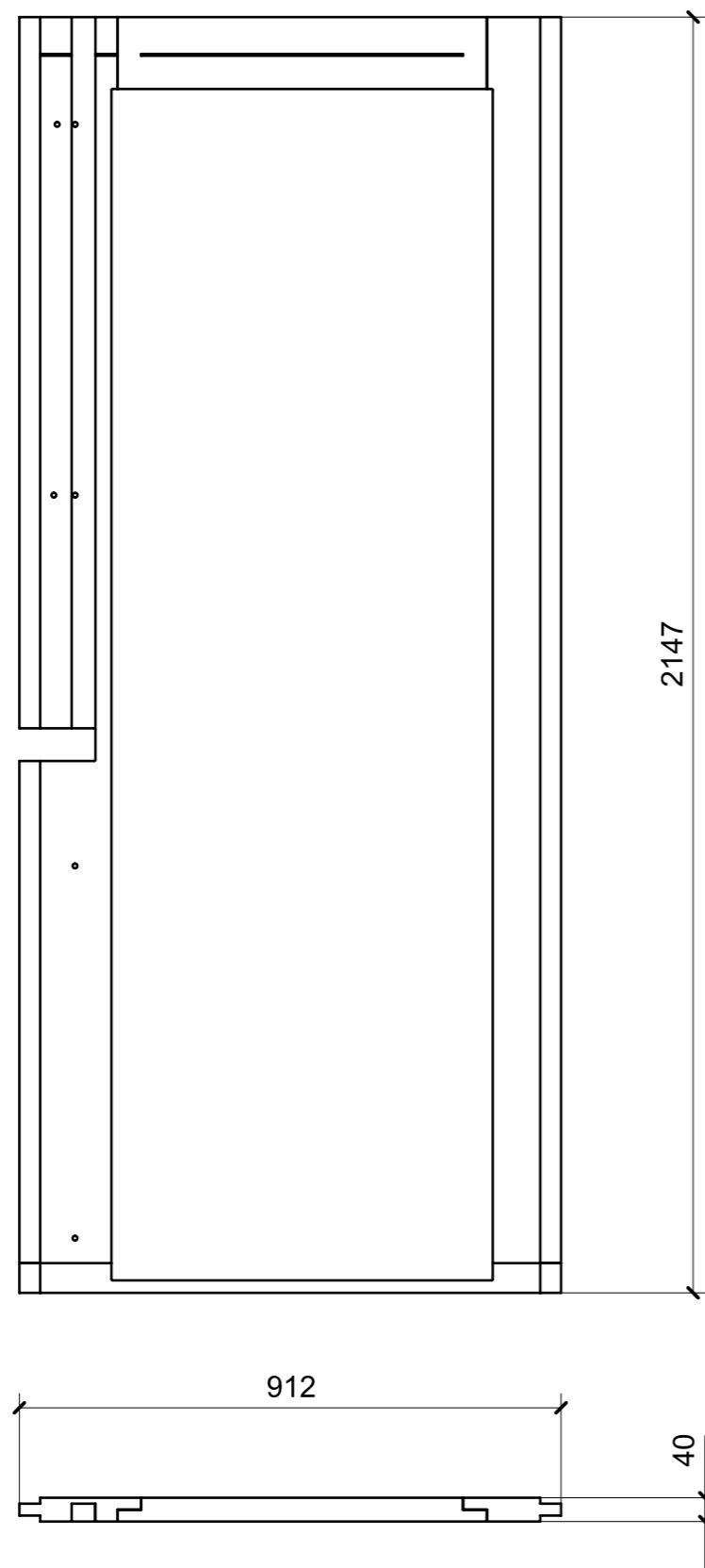

01

LOCALE	CODICE	DESCRIZIONE COMPONENTE	FINITURA	GR.
PARATIE LD	MD320_PR31	PARATIA PORTA CABINA OSPITI SX POPPA	LARICROSS/OKUME' GREZZO	2

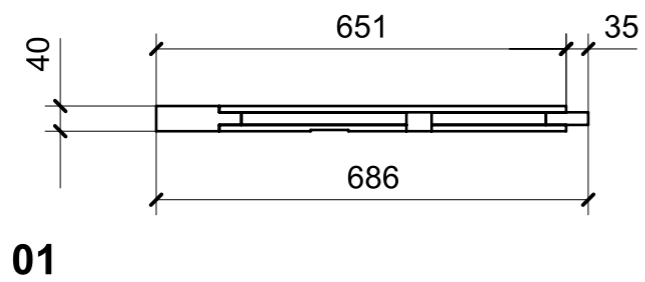
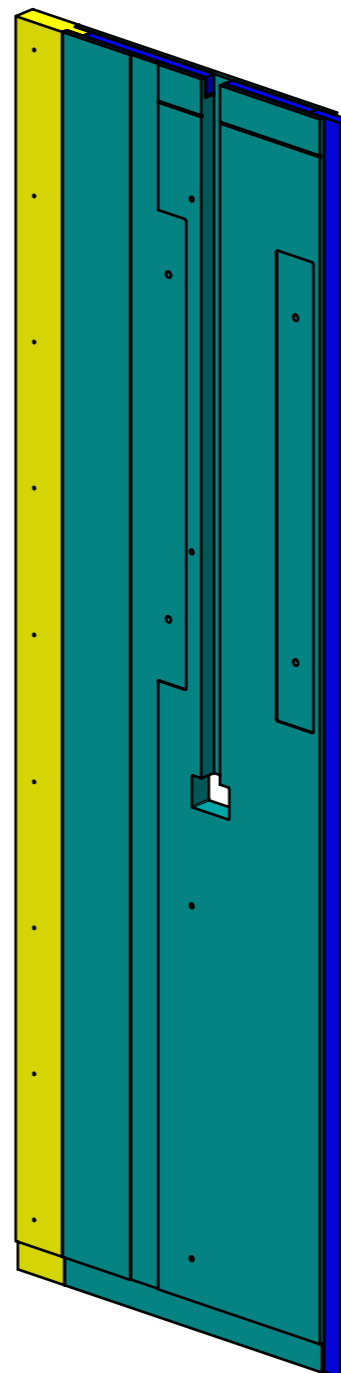
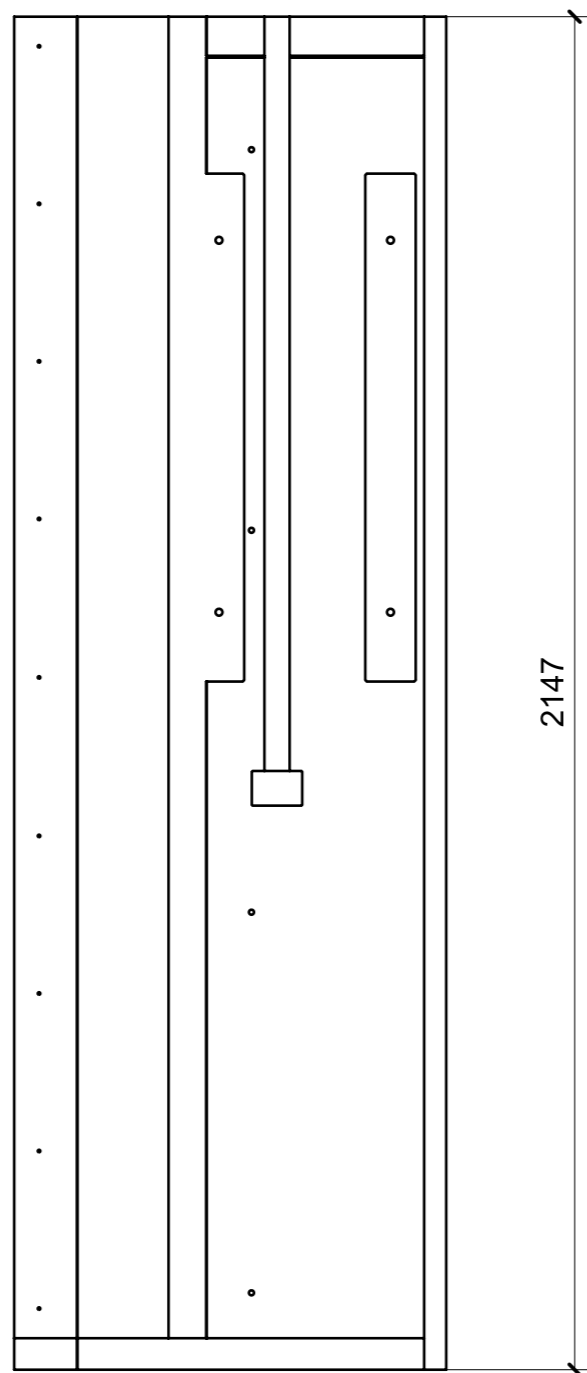

LOCALE	CODICE	DESCRIZIONE COMPONENTE	FINITURA	GR.
PARATIE LD	MD320_PR32	PARATIA PORTA CABINA OSPITI SX	LARICROSS	2

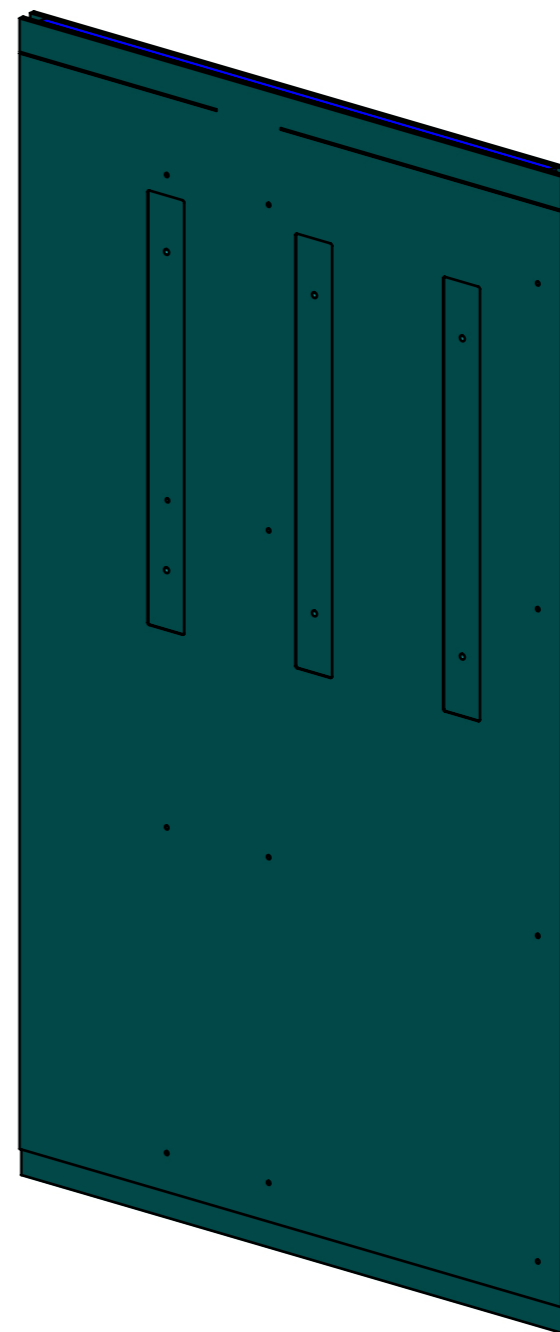
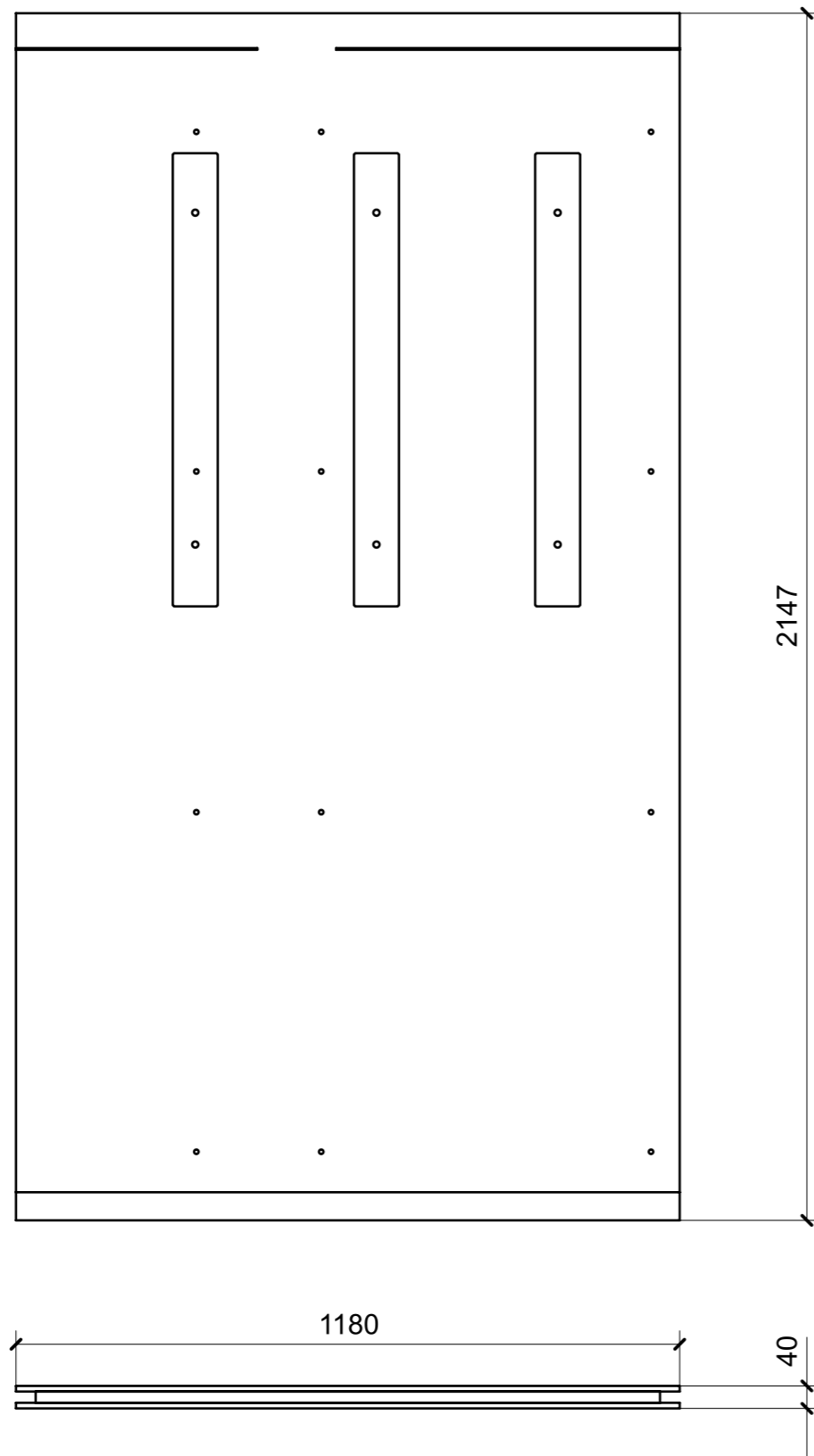

01

LOCALE	CODICE	DESCRIZIONE COMPONENTE	FINITURA	GR.
PARATIE LD	MD320_PR33	PARATIA PORTA CABINA OSPITI SX	OKUME' GREZZO	PTP

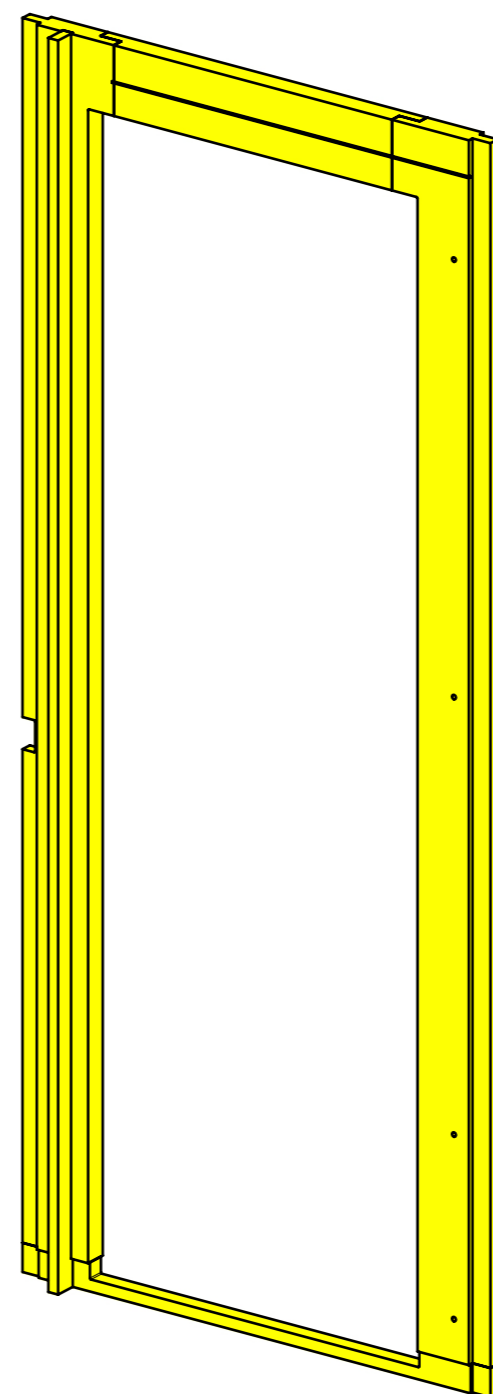
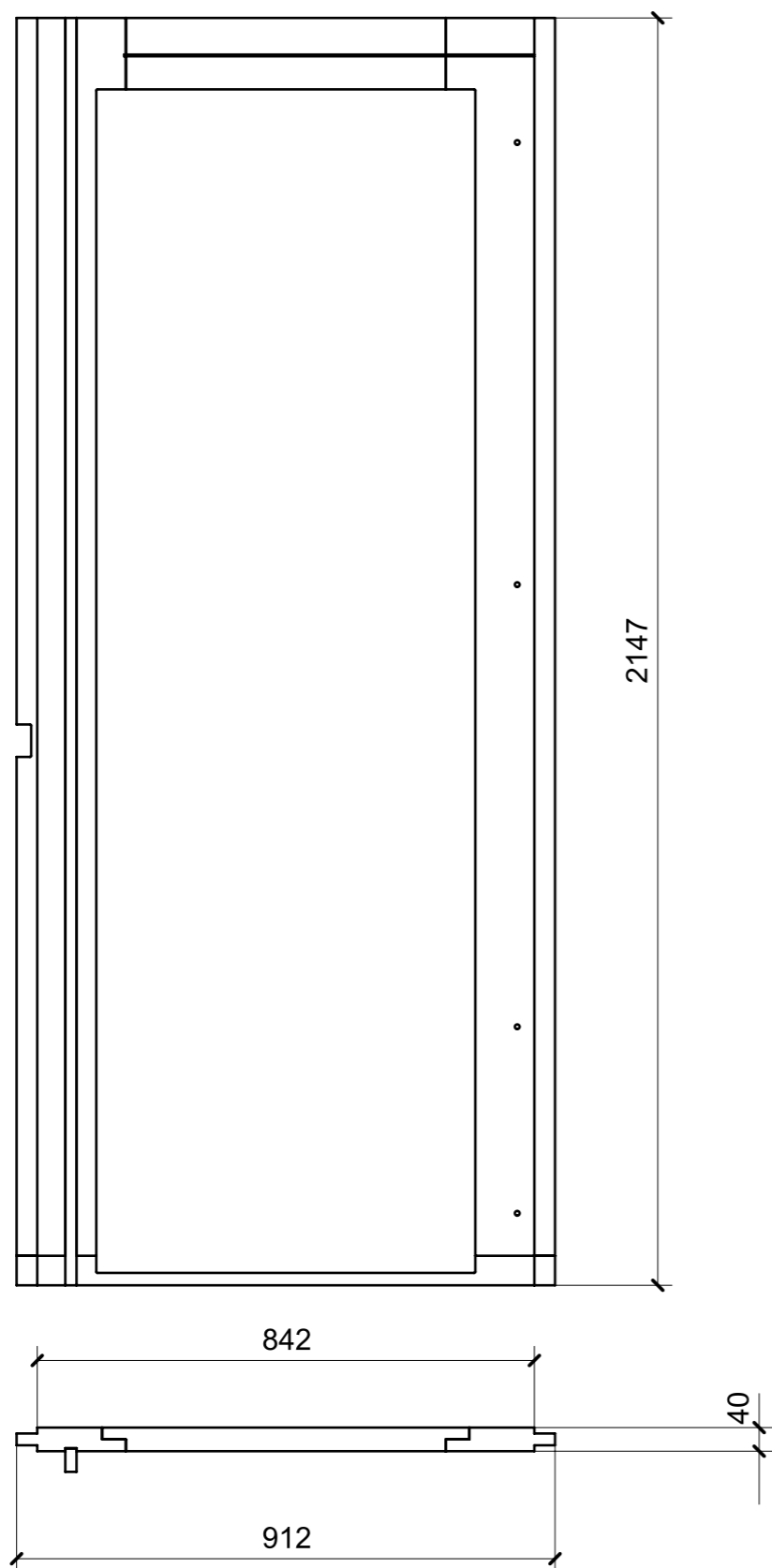

01

LOCALE	CODICE	DESCRIZIONE COMPONENTE	FINITURA	GR.
PARATIE LD	MD320_PR34	PARATIA PORTA BAGNO OSPITI SX	LARICROSS/OKUME' GREZZO	2

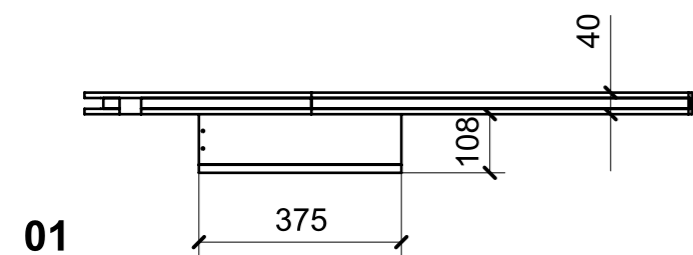
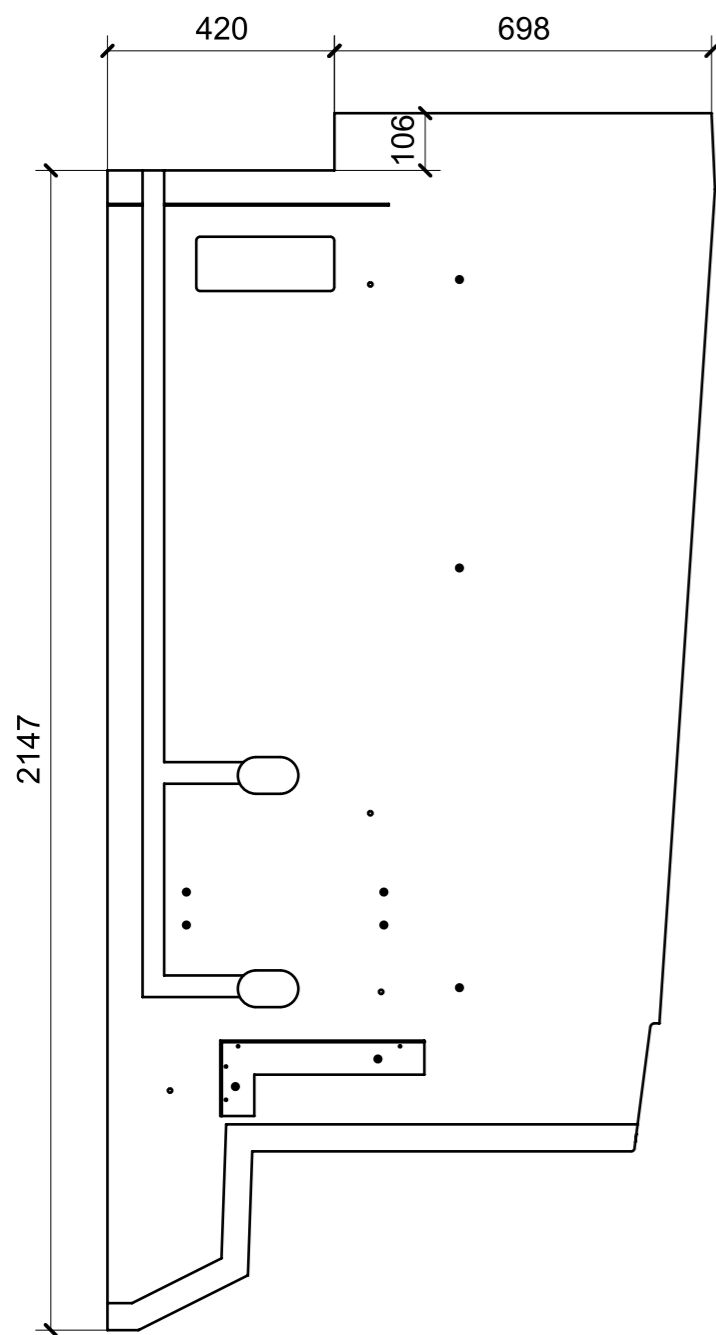

01
LARICROSS

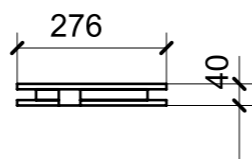
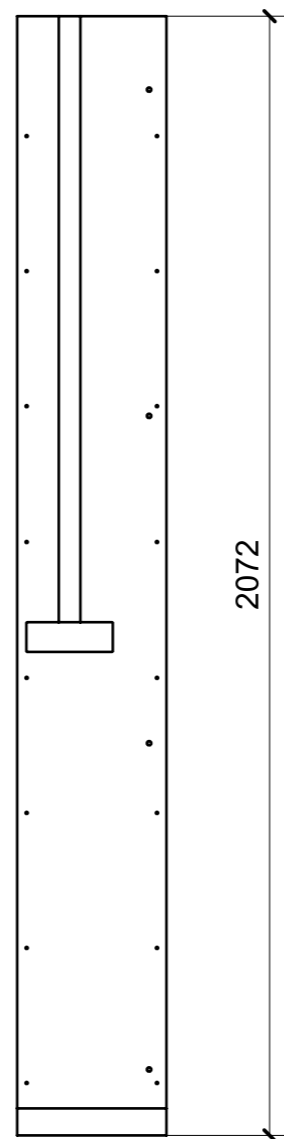

03
LARICROSS

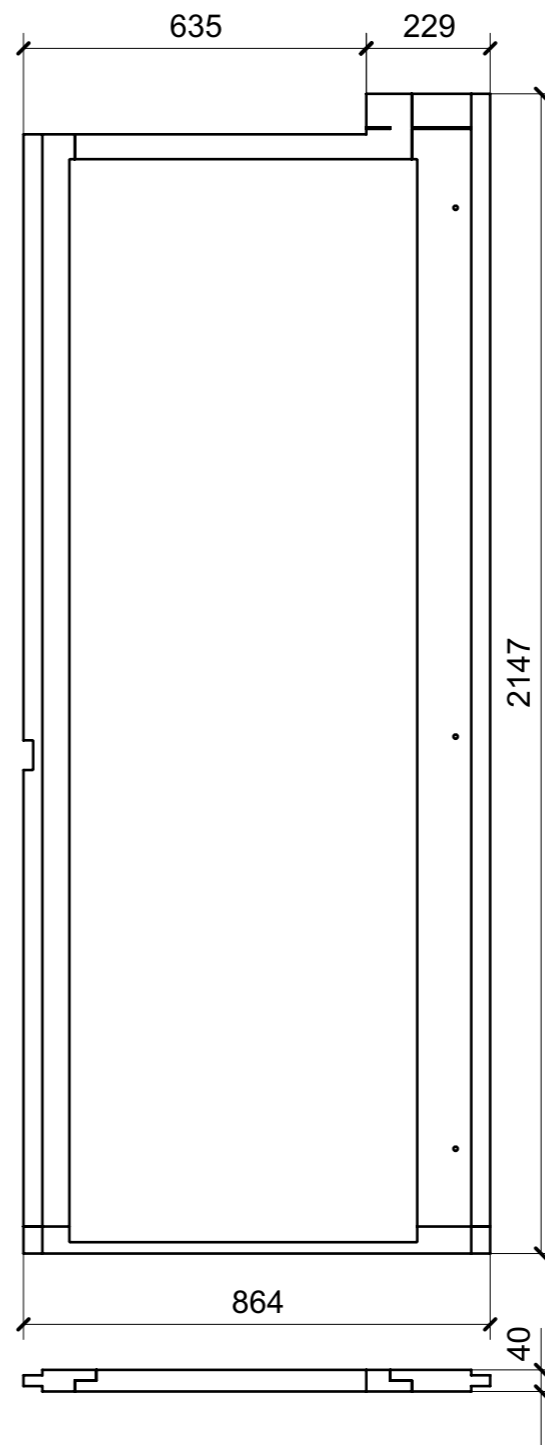

02
OKUME' GREZZO

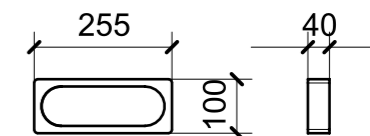

04
GREZZO SPRUZZATO NERO

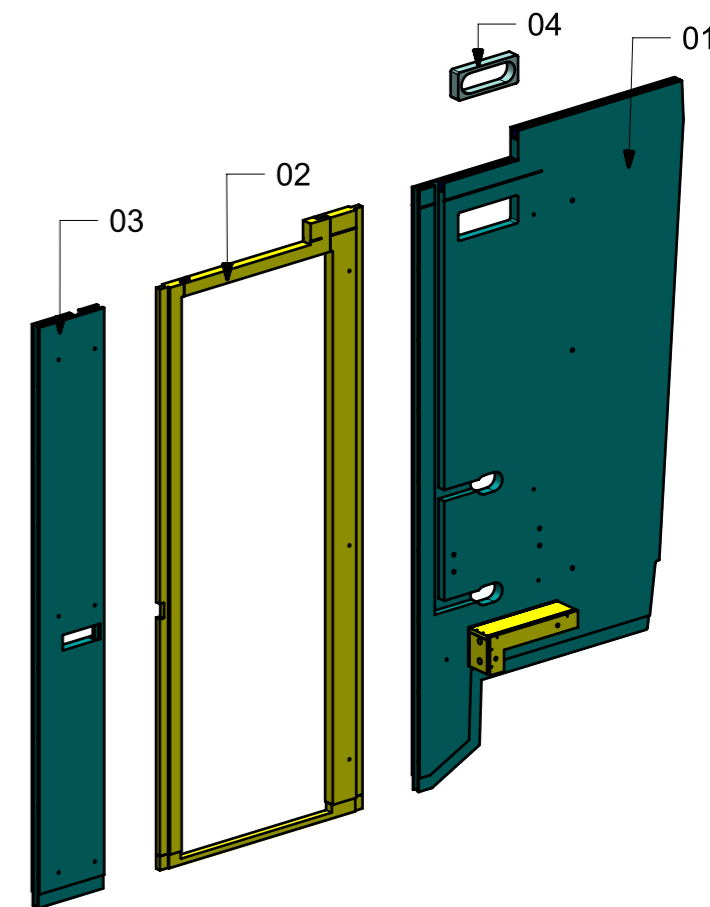

FERRAMENTA	QTY
BUSSOLA 6MA X 10 FORO DIAM.8	13

LOCALE	CODICE	DESCRIZIONE COMPONENTE	FINITURA	GR.
PARATIE LD	MD320_PR35	PARATIA PORTA BAGNO OSPITI SX_LOBBY LUNGONAVE	LARICROSS/OKUME' GREZZO	PTP

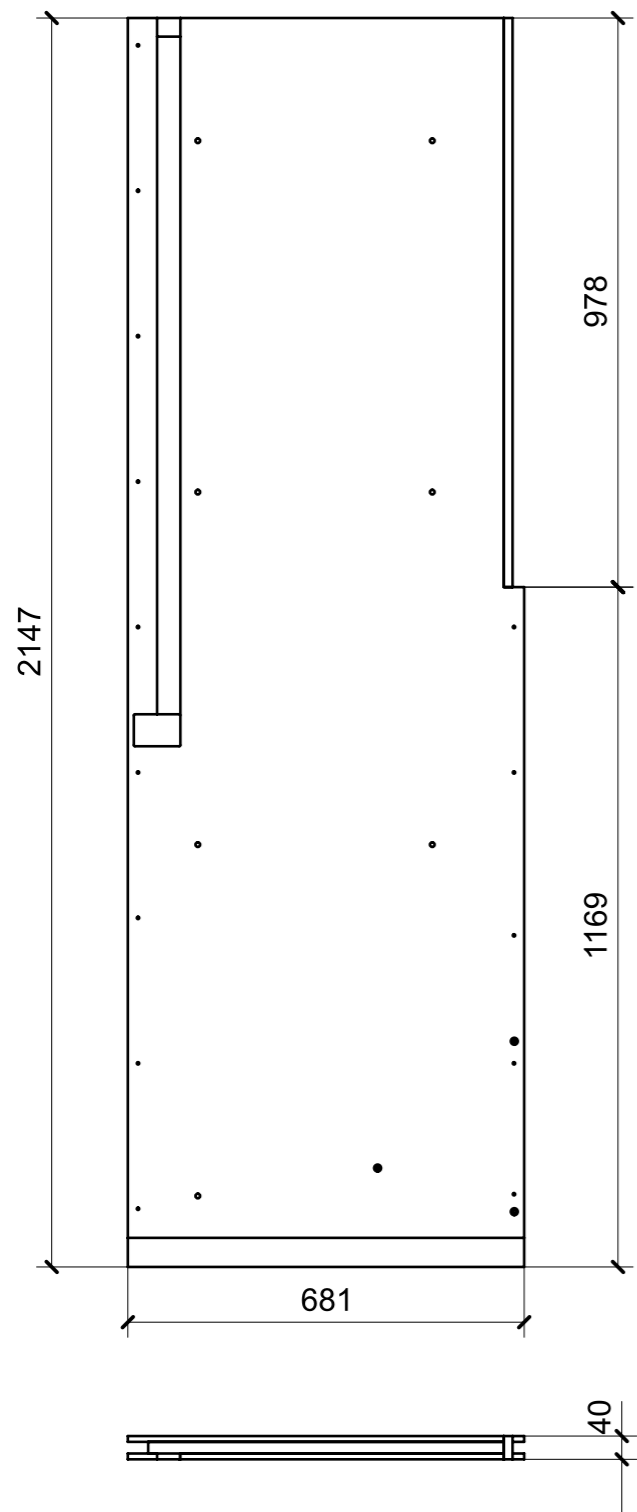

01

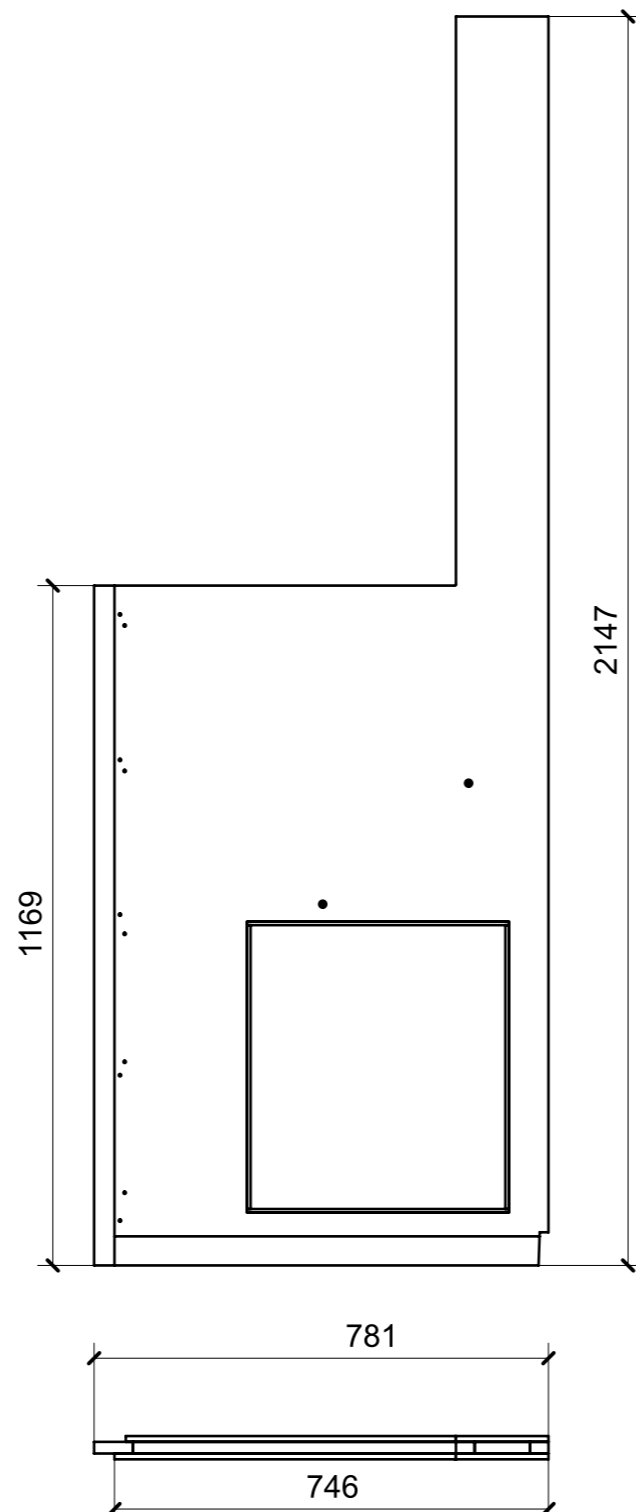

02

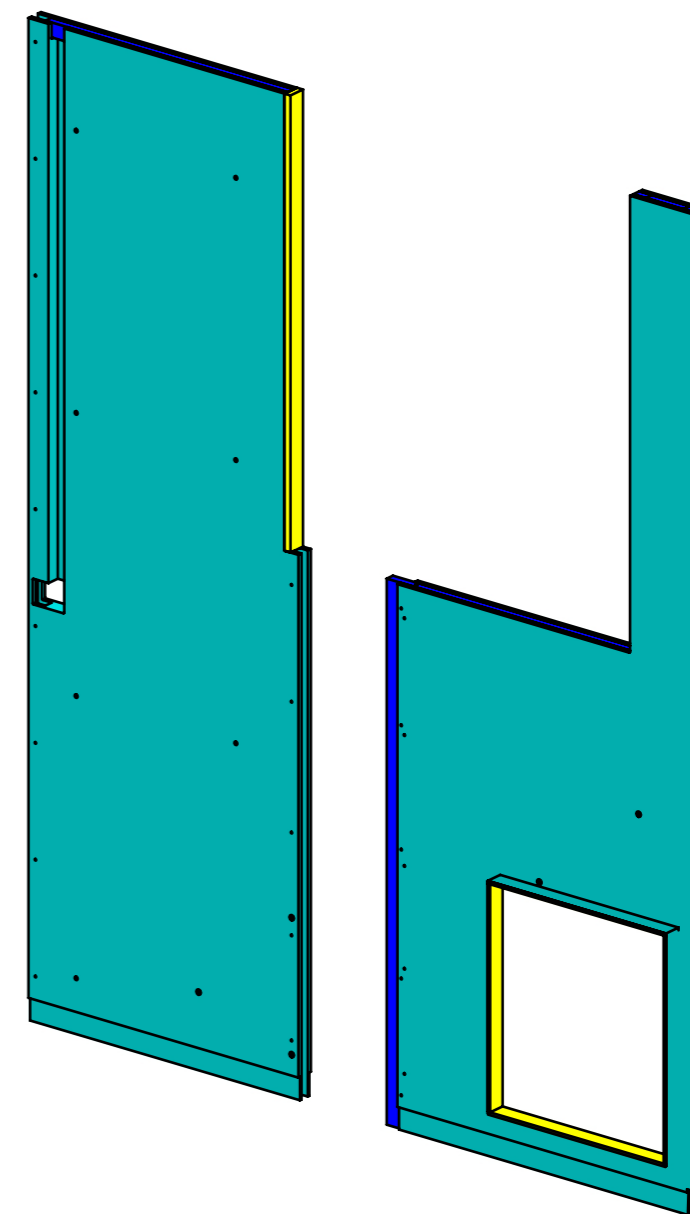

FERRAMENTA	QTY
BUSSOLA 6MA X 10 FORO DIAM.8	5

LOCALE	CODICE	DESCRIZIONE COMPONENTE	FINITURA	GR.
PARATIE LD	MD320_PR36	PARATIA PORTA DOCCIA BAGNO OSPITI SX MURATA	OKUME' GREZZO	PTP

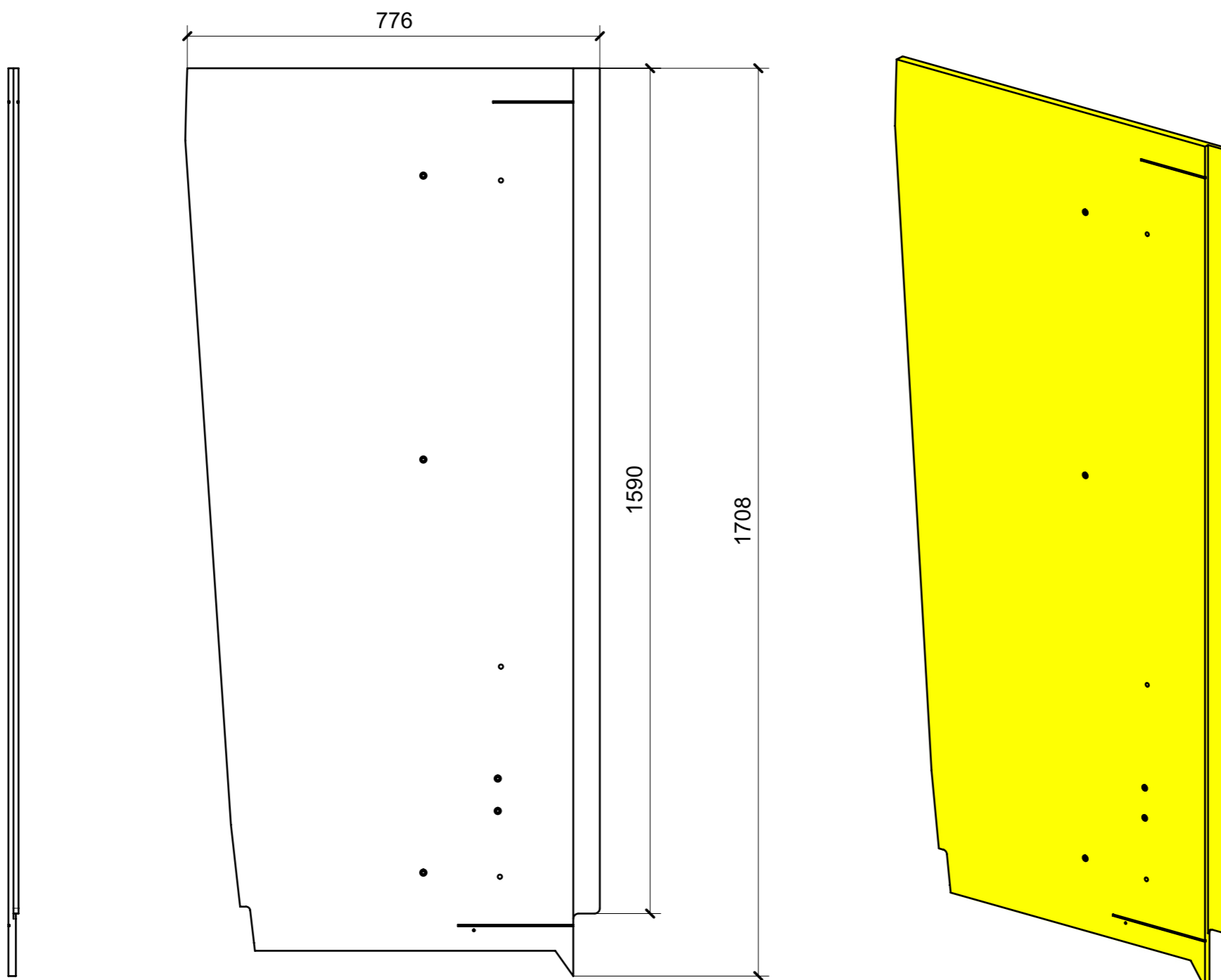

FERRAMENTA	QTY
BUSSOLA 6MA X 10 FORO DIAM.8	5

01

LOCALE	CODICE	DESCRIZIONE COMPONENTE	FINITURA	GR.
PARATIE LD	MD320_PR37	PARATIA PORTA DOCCIA BAGNO OSPITI SX	OKUME' GREZZO	PTP

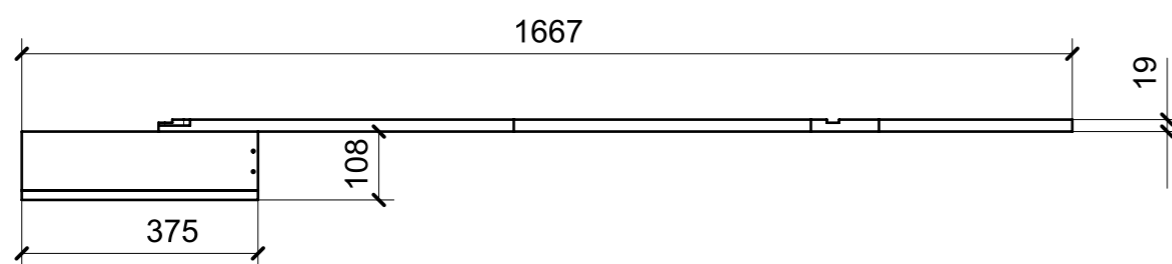
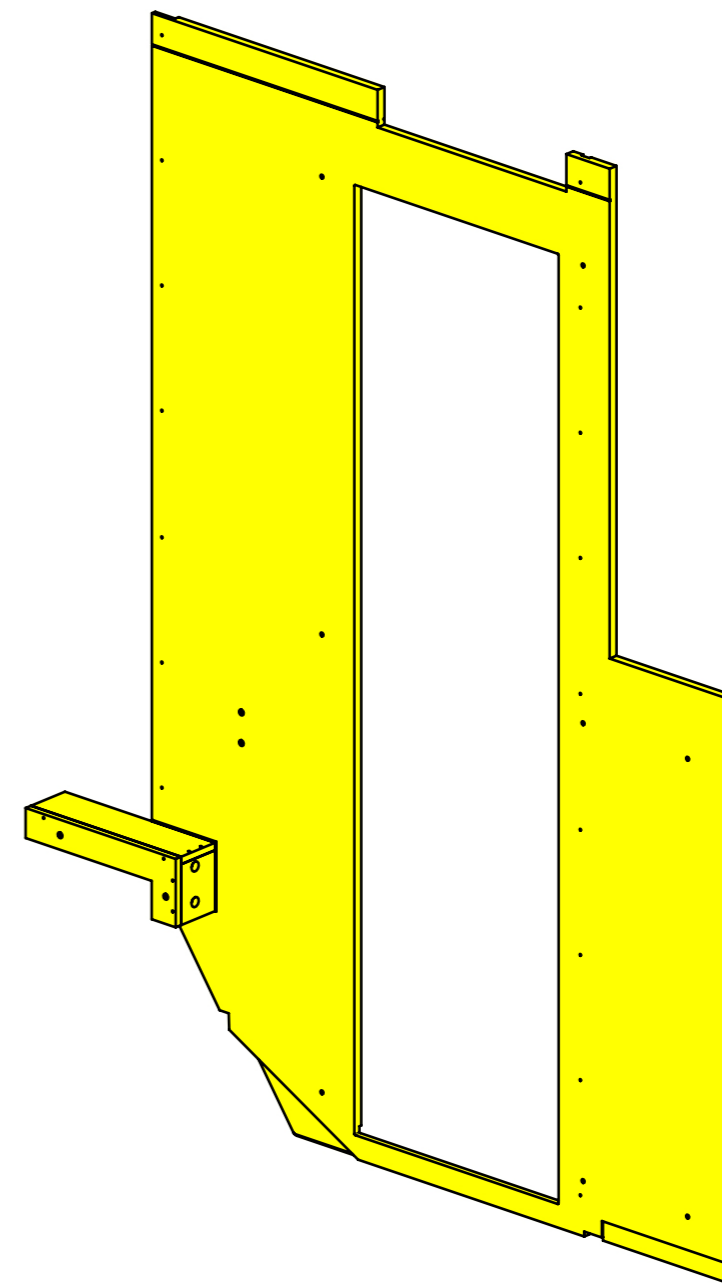
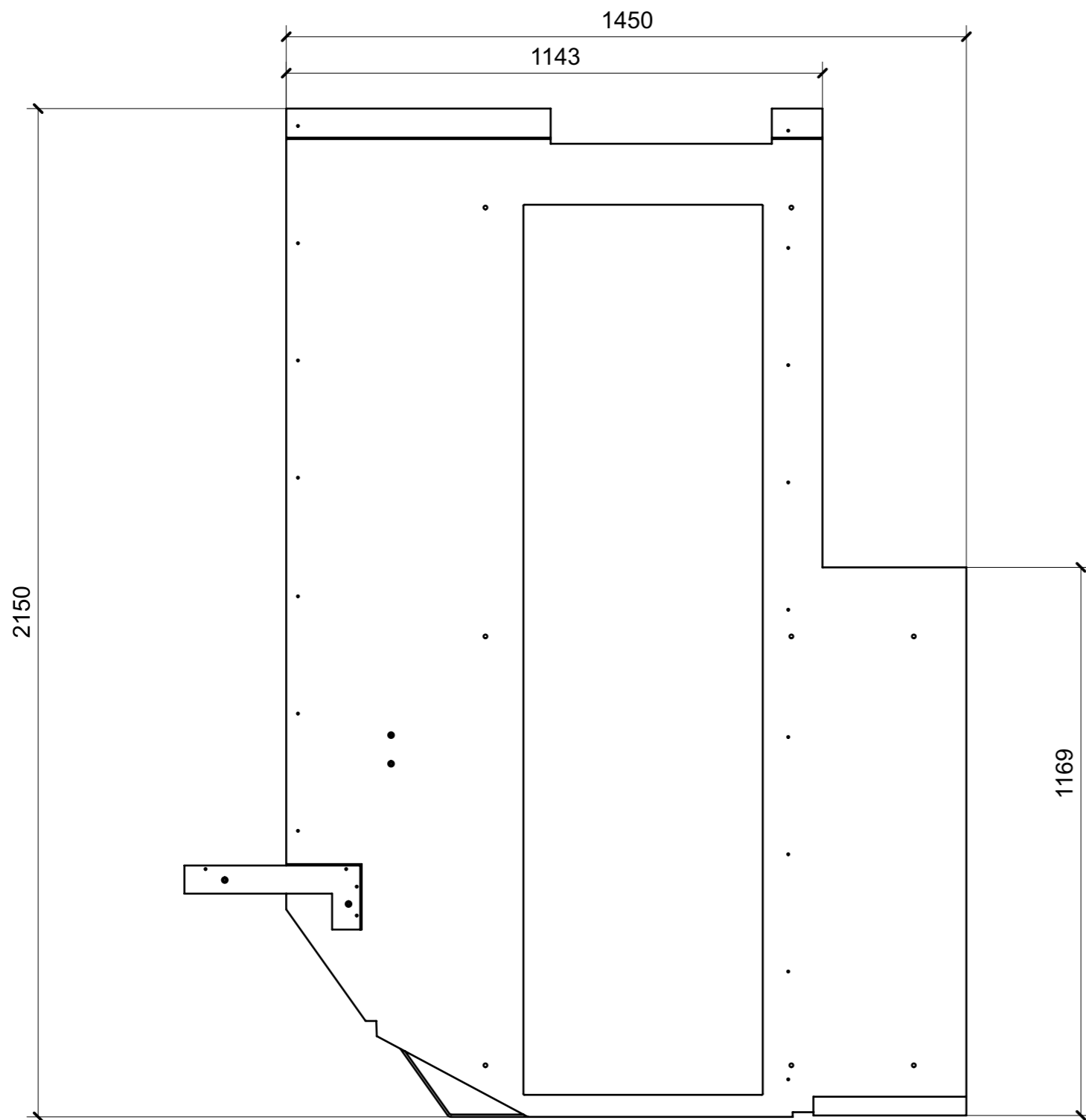

01

FERRAMENTA	QTY
BUSSOLA 6MA X 10 FORO DIAM.8	4

LOCALE	CODICE	DESCRIZIONE COMPONENTE	FINITURA	GR.
PARATIE LD	MD320_PR38	PARATIA DOCCIA BAGNO OSPITI SX LUNGONAVE	OKUME' GREZZO	2

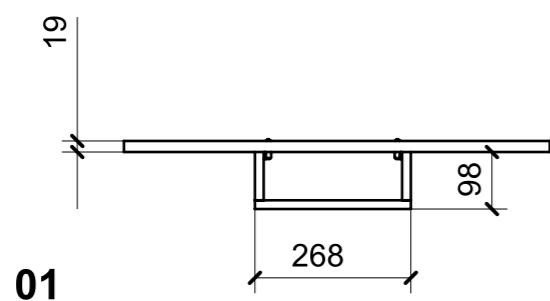
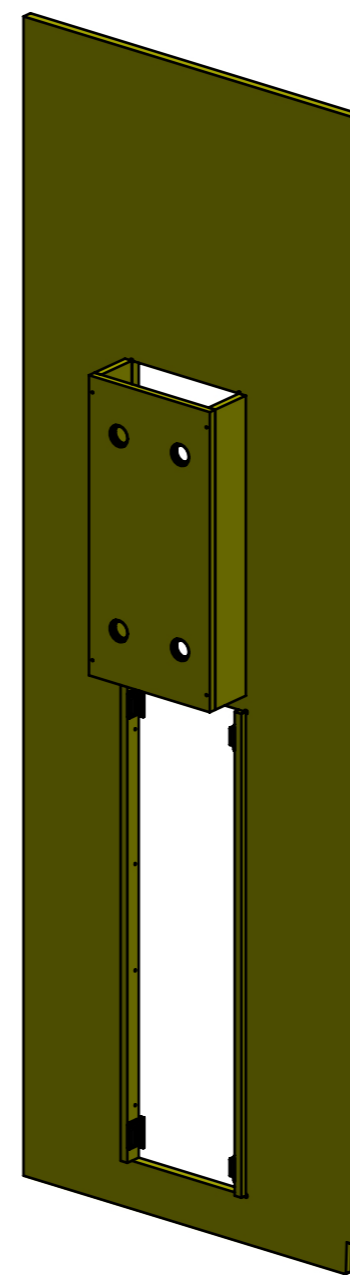
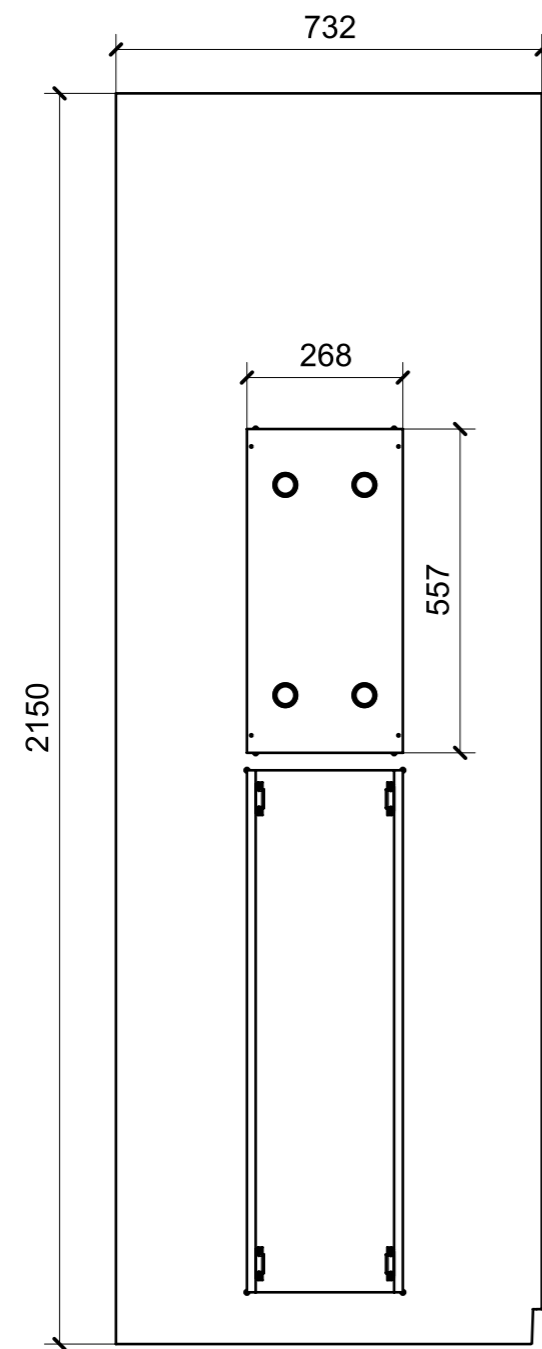

01

FERRAMENTA	QTY
FITLOCK F_MASCHERPA_6020101102	4
CHIUSURA A SPINTA_TECHNOPARTNER_SOU C3-203	4

LOCALE	CODICE	DESCRIZIONE COMPONENTE	FINITURA	GR.
PARATIE LD	MD320_PR39	PARATIA PORTA BAGNO OSPITI DX MURATA	LARICROSS/OKUME'	PTP

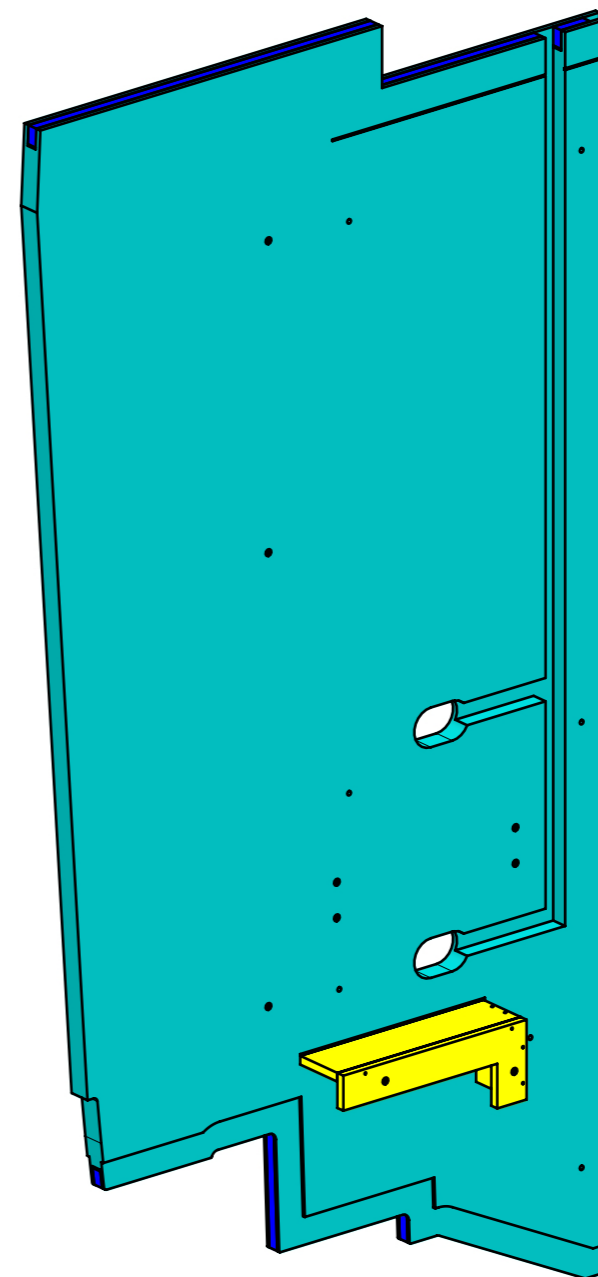
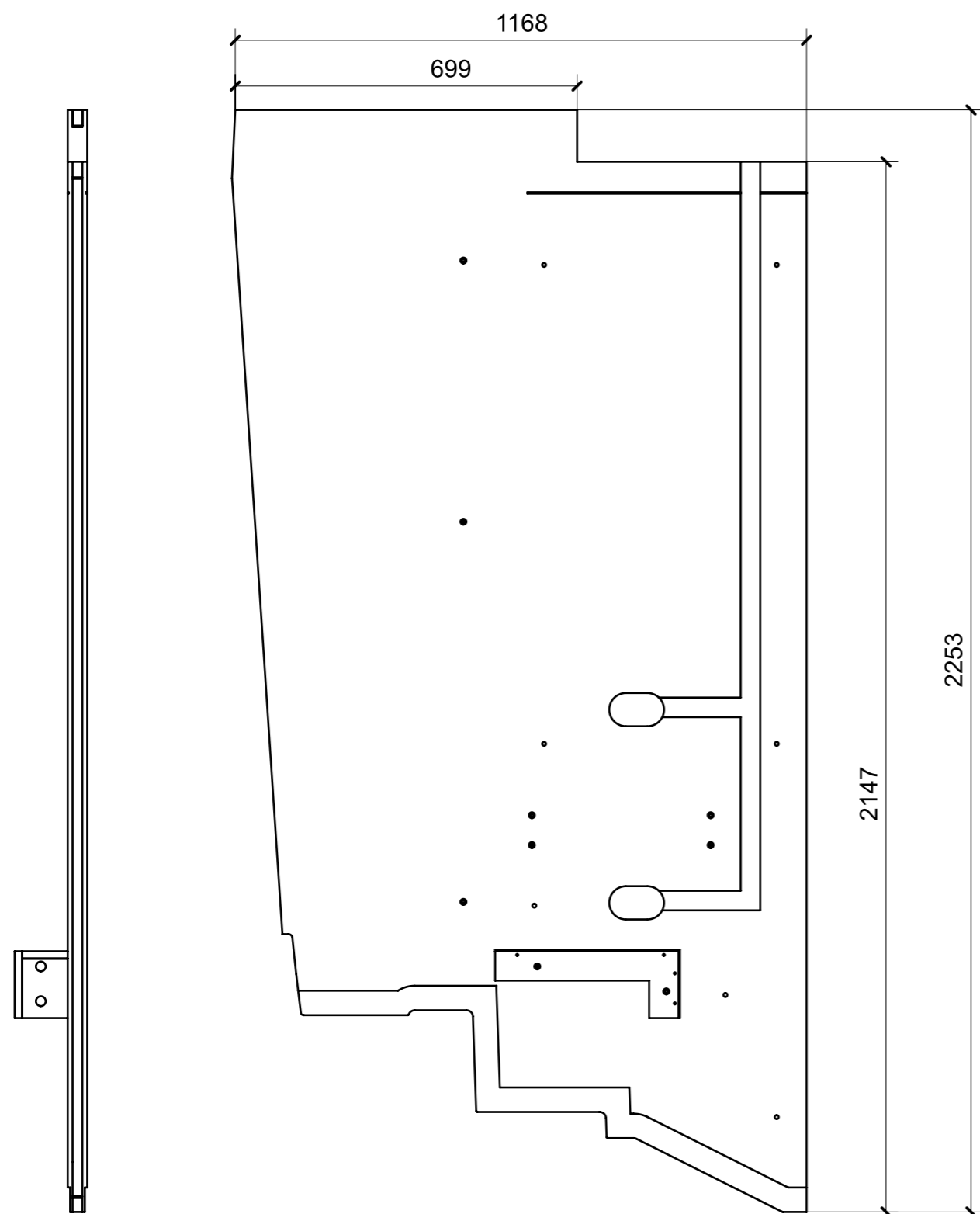

FERRAMENTA	QTY
BUSSOLA 6MA X 10 FORO DIAM.8	12

LOCALE	CODICE	DESCRIZIONE COMPONENTE	FINITURA	GR.
PARATIE LD	MD320_PR40	PARATIA PORTA BAGNO OSPITI DX	LARICROSS/OKUME' GREZZO	2

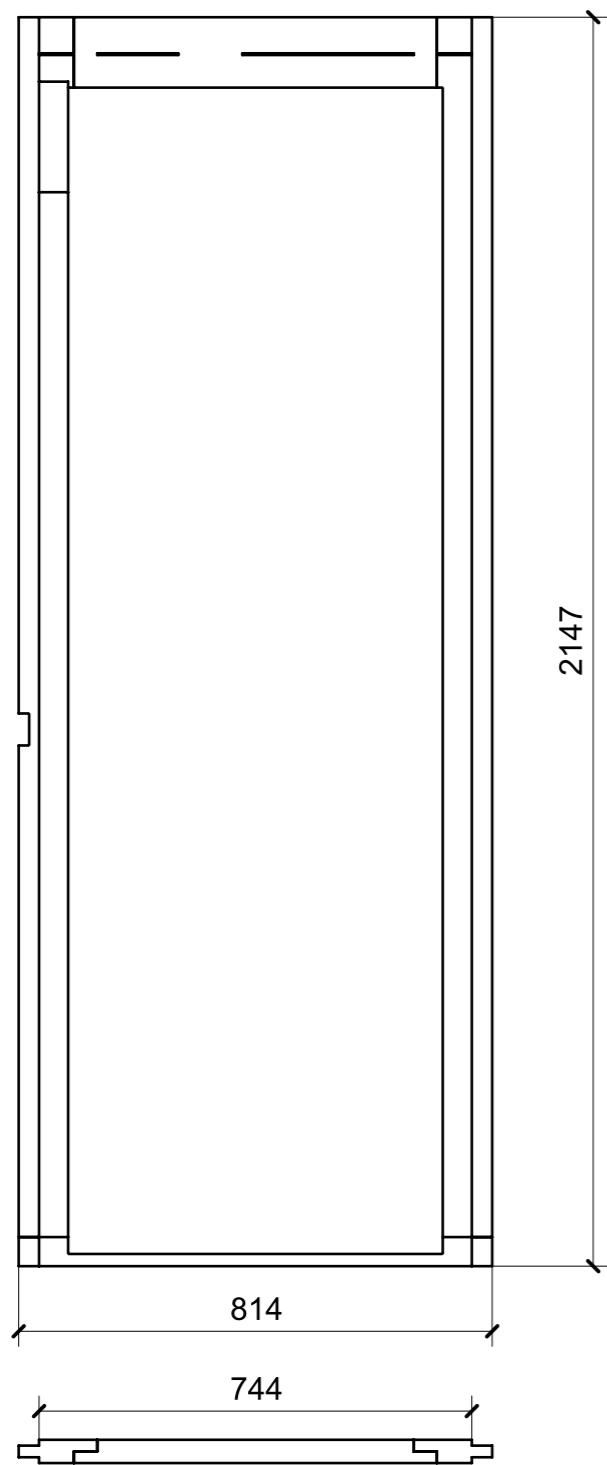

01
OKUME' GREZZO

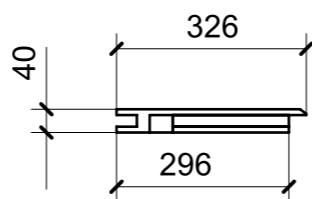
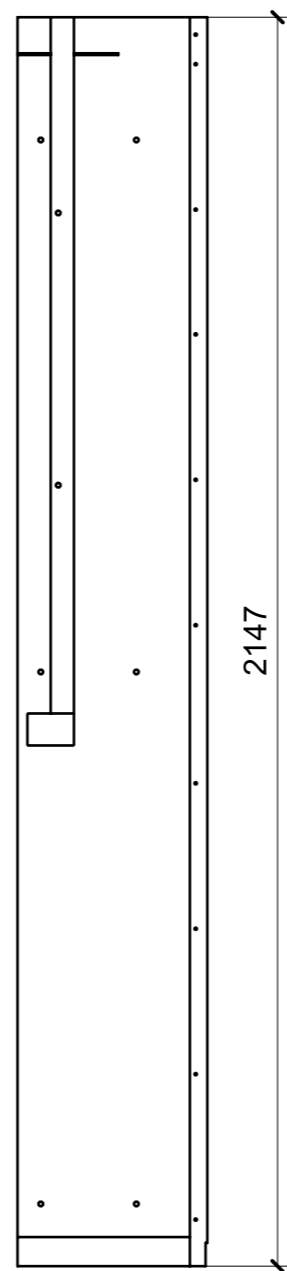

02
LARICROSS

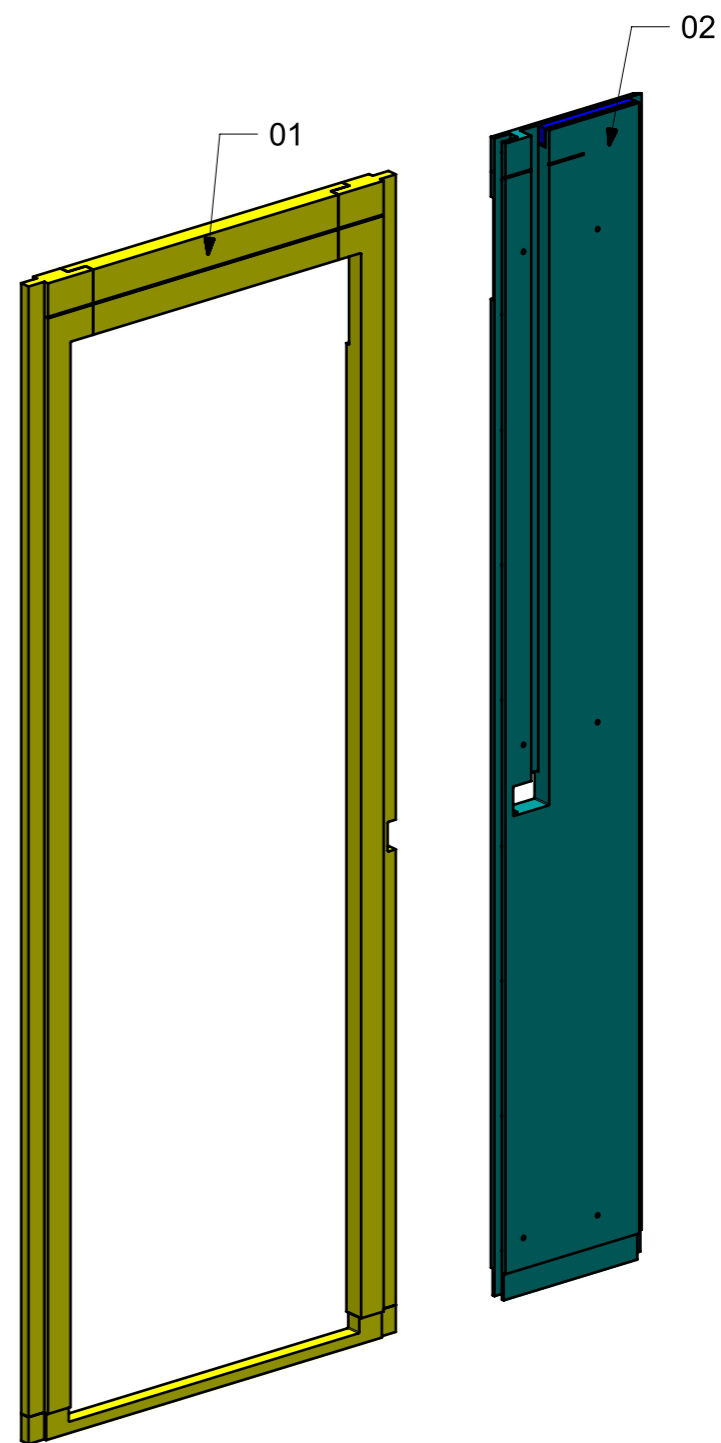

LOCALE	CODICE	DESCRIZIONE COMPONENTE	FINITURA	GR.
PARATIE LD	MD320_PR41	PARATIA PORTA BAGNO OSPITI DX A.C	LARICROSS/ GREZZO SPRUZZATO NERO	2

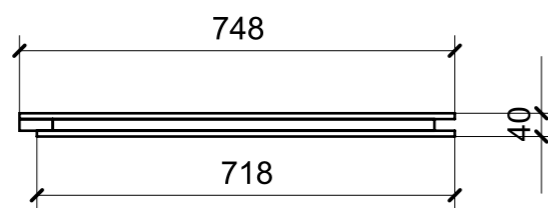
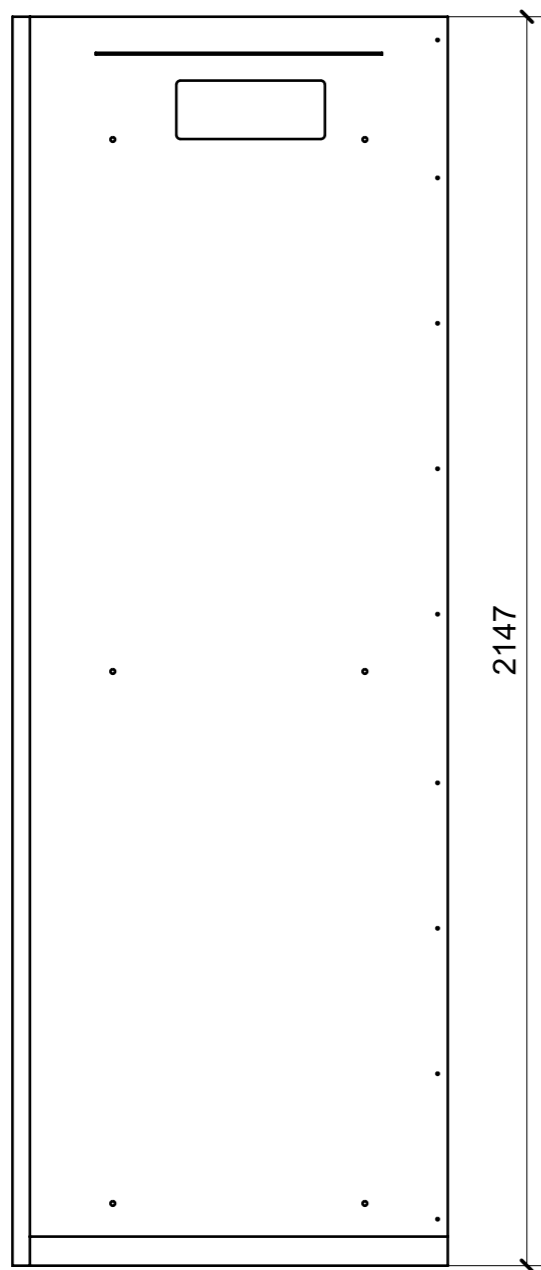

01
LARICROSS

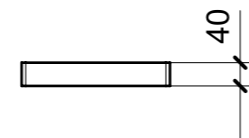
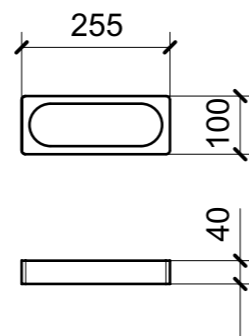

02
GREZZO SPRUZZATO NERO

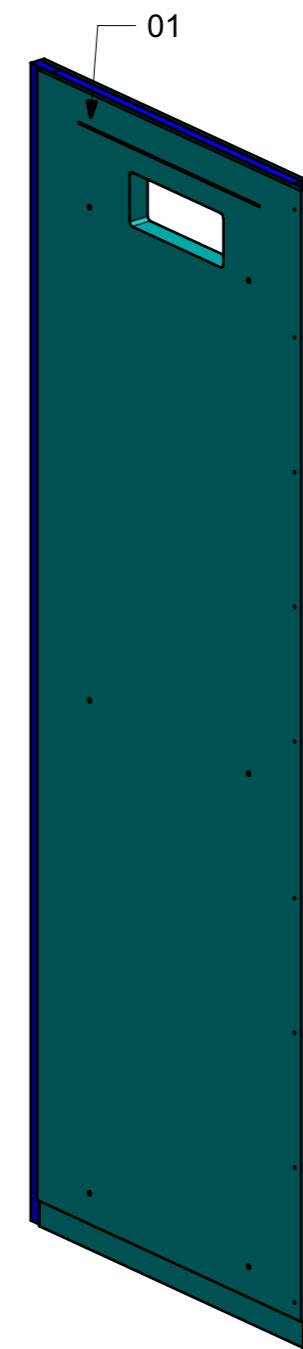
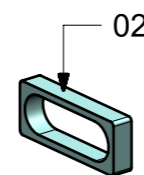

LOCALE	CODICE	DESCRIZIONE COMPONENTE	FINITURA	GR.
PARATIE LD	MD320_PR42	PARATIA CABINA OSPITI DX_LOBBY DX PRUA	LARICROSS	PTP

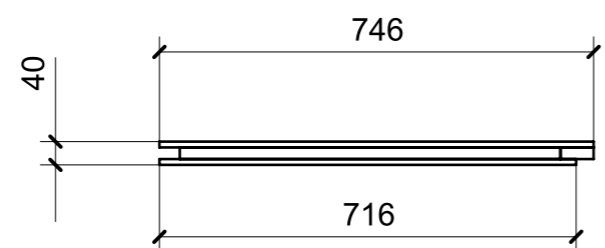
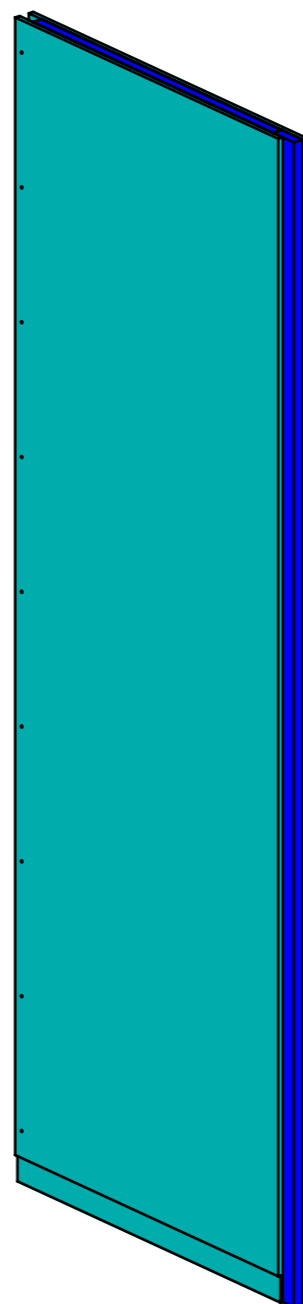
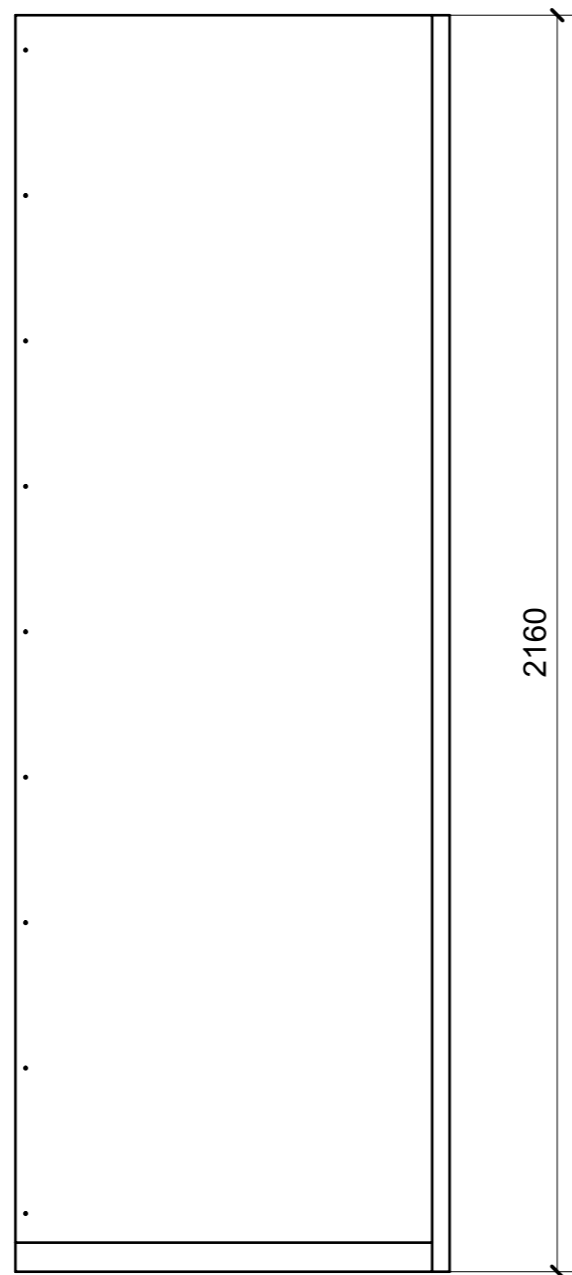

01

FERRAMENTA	QTY
BUSSOLA 6MA X 10 FORO DIAM.8	3

LOCALE	CODICE	DESCRIZIONE COMPONENTE	FINITURA	GR.
PARATIE LD	MD320_PR43	PARATIA CABINA OSPITI DX PRUA	LARICROSS / OKUME'	PTP

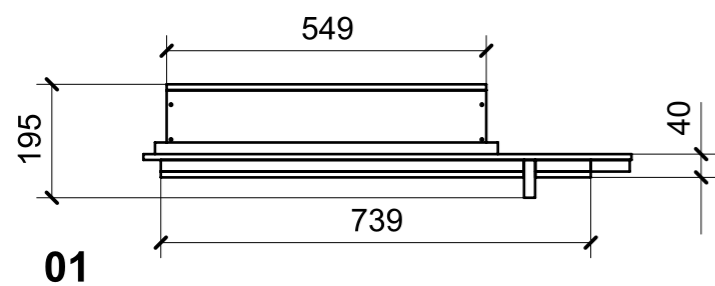
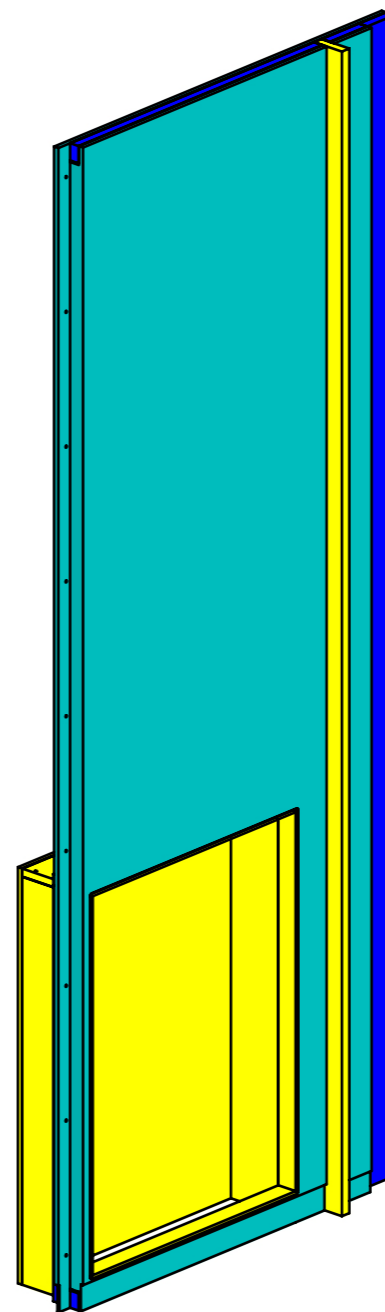
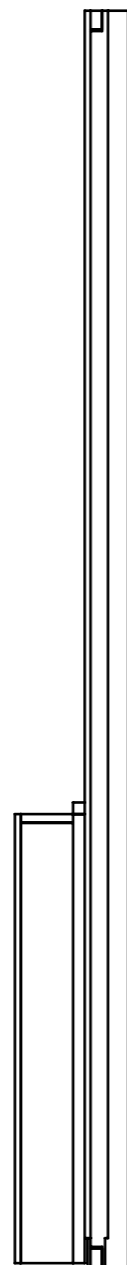
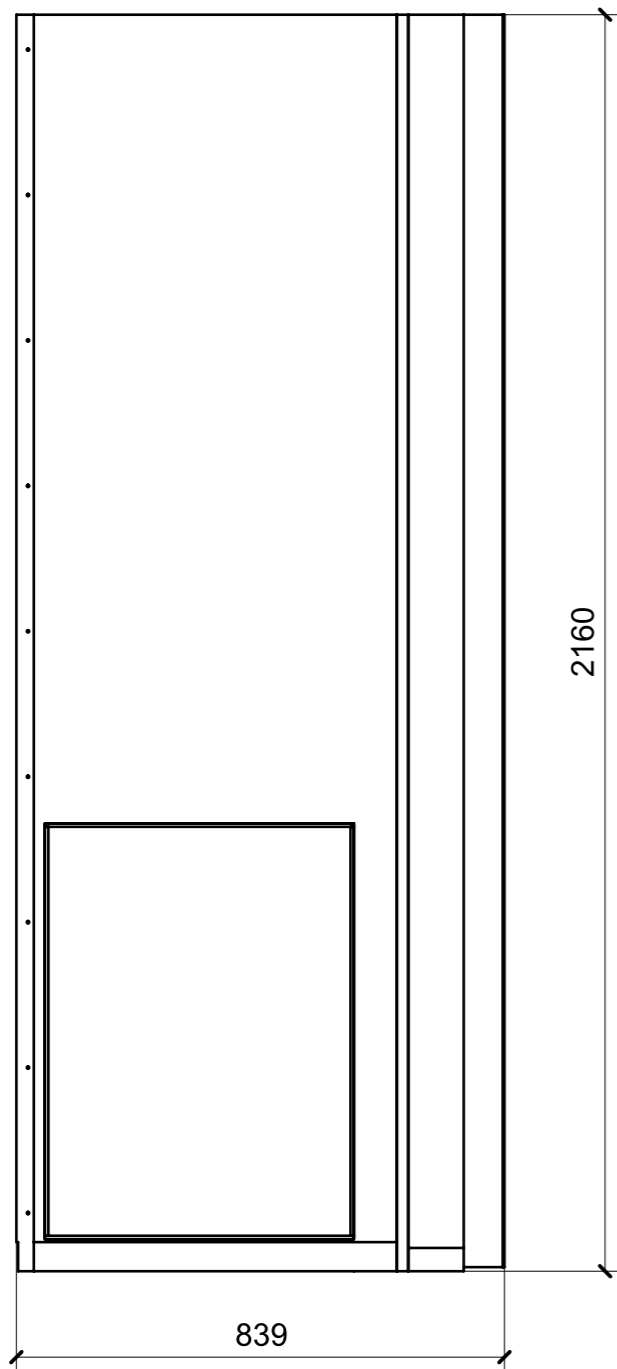

01

FERRAMENTA	QTY
BUSSOLA 6MA X 10 FORO DIAM.8	3

LOCALE	CODICE	DESCRIZIONE COMPONENTE	FINITURA	GR.
PARATIE LD	MD320__PR44	PARATIA PORTA DOCCIA BAGNO OSPITI DX	OKUME' GREZZO	PTP

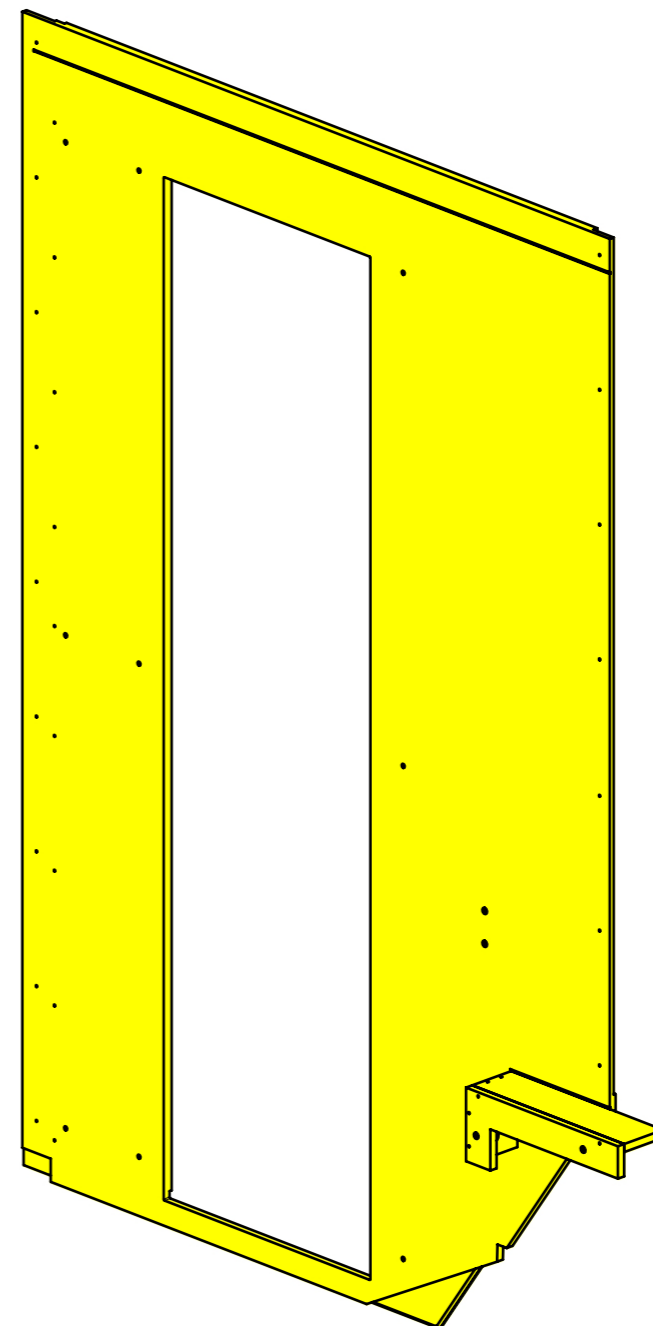
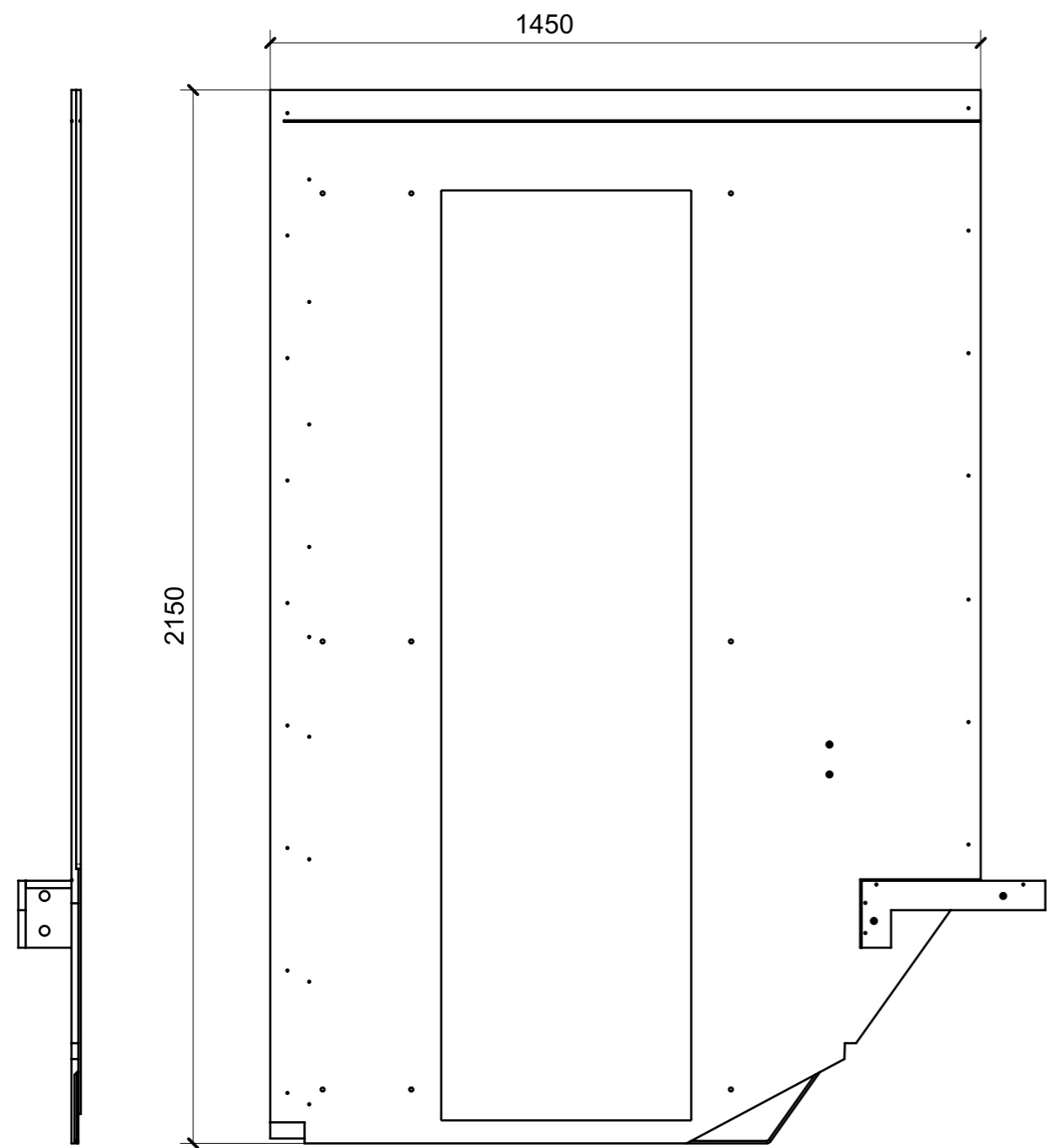

01

FERRAMENTA	QTY
BUSSOLA 6MA X 10 FORO DIAM.8	4

LOCALE	CODICE	DESCRIZIONE COMPONENTE	FINITURA	GR.
PARATIE LD	MD320_PR45	PARATIA BAGNO OSPITI DX CENTRO NAVE	OKUME' GREZZO	2

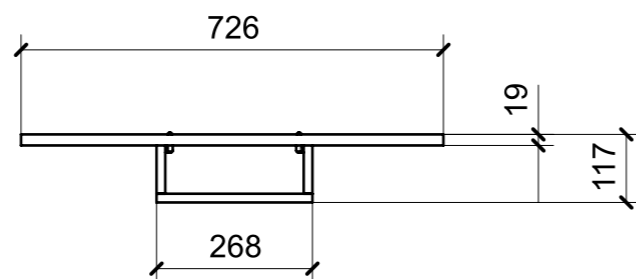
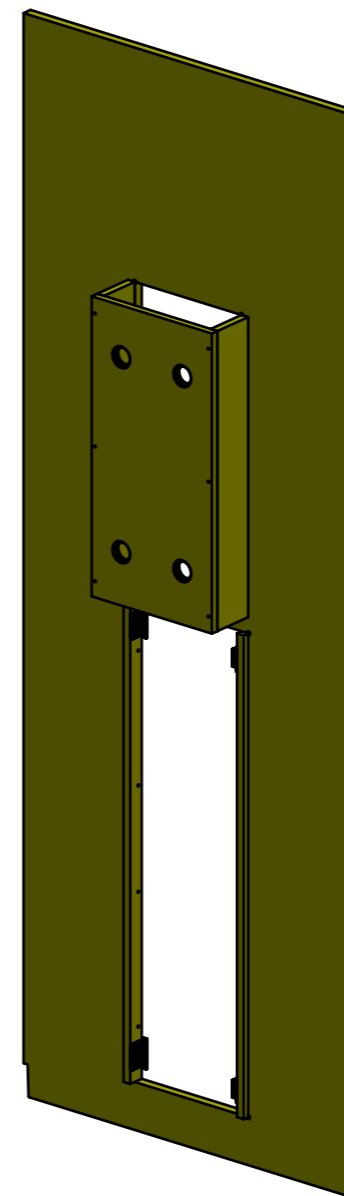
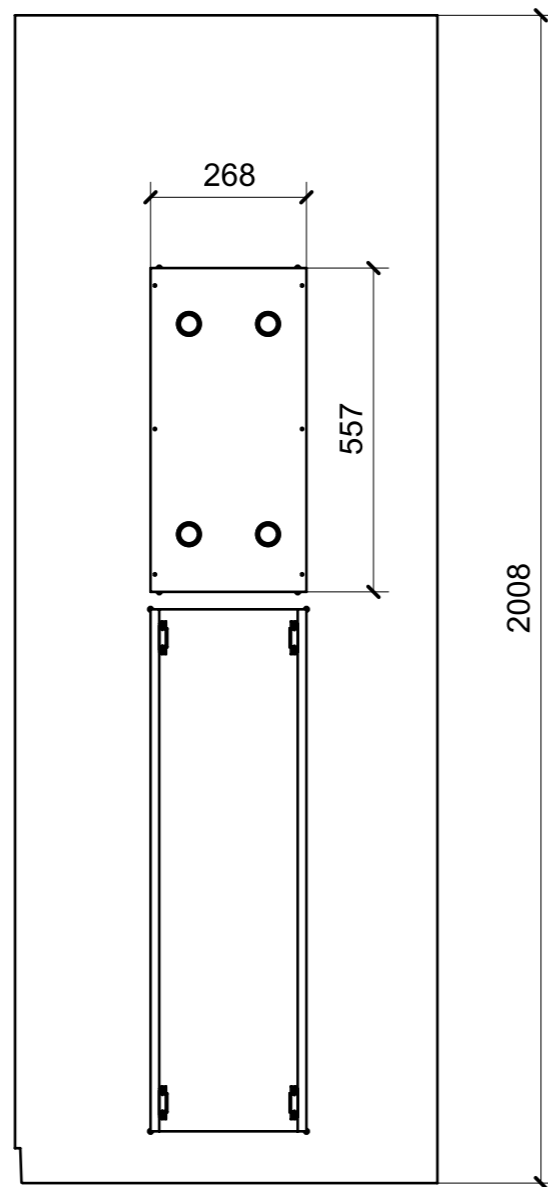

01

FERRAMENTA	QTY
CHIUSURA A SPINTA_TECHNOPARTNER_SOU C3-203	4
FITLOCK F_MASCHERPA_6020101102	4

LOCALE	CODICE	DESCRIZIONE COMPONENTE	FINITURA	GR.
PARATIE LD	MD320_PR46	PARATIA PORTA DOCCIA BAGNO OSPITI DX	OKUME' GREZZO	PTP

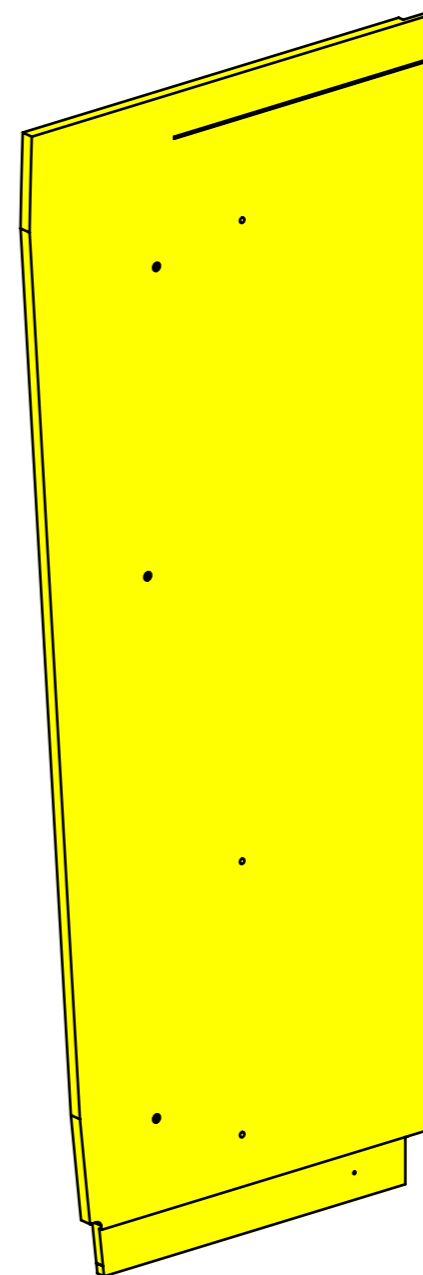
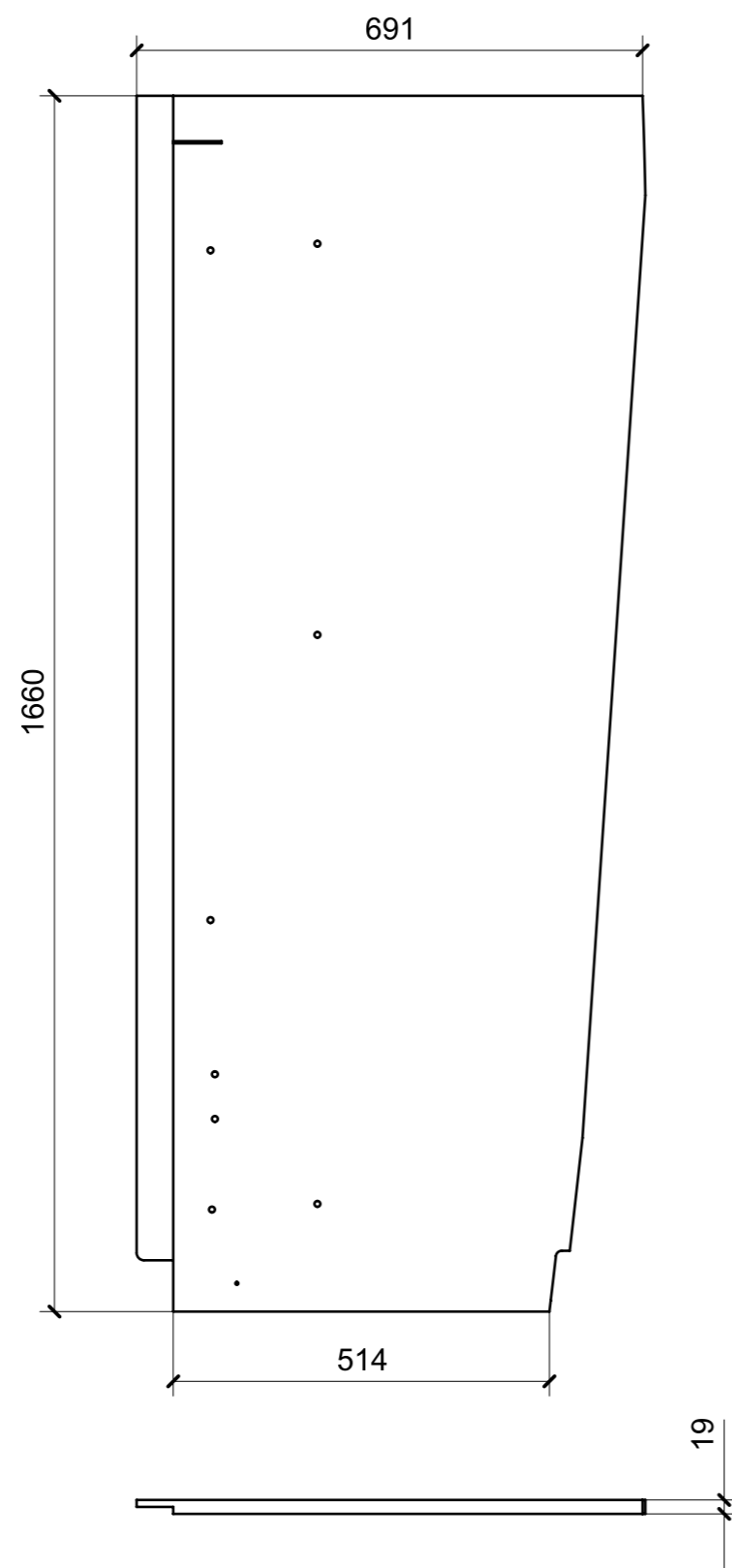

01

FERRAMENTA	QTY
BUSSOLA 6MA X 10 FORO DIAM.8	3