

LOCALE	CODICE	DESCRIZIONE COMPONENTE	FINITURA	GR
CABINA VIP SX	MD320_VVA01	STRUTTURA MURATA TESTATA LETTO	OKUME' GREZZO	2

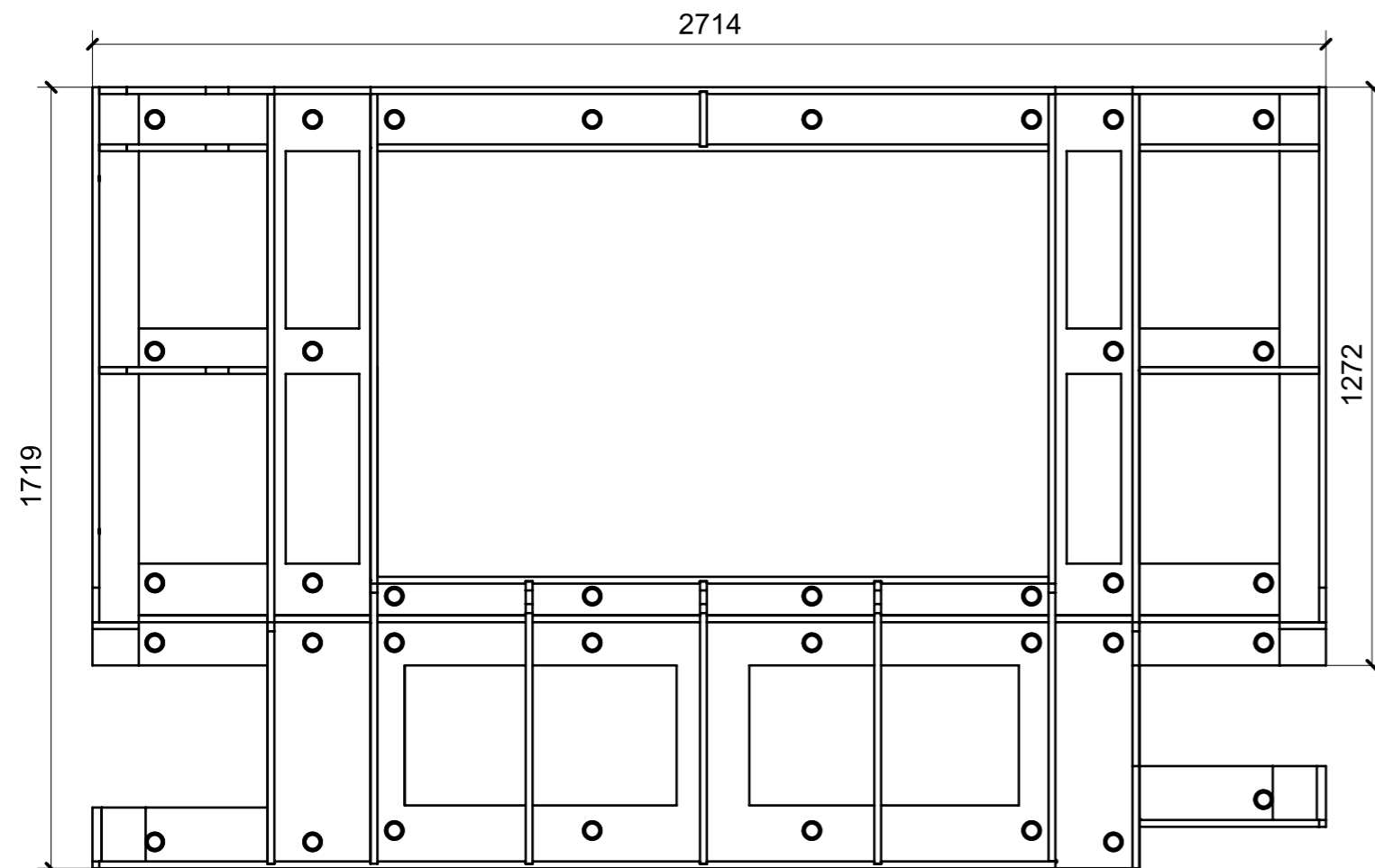

01

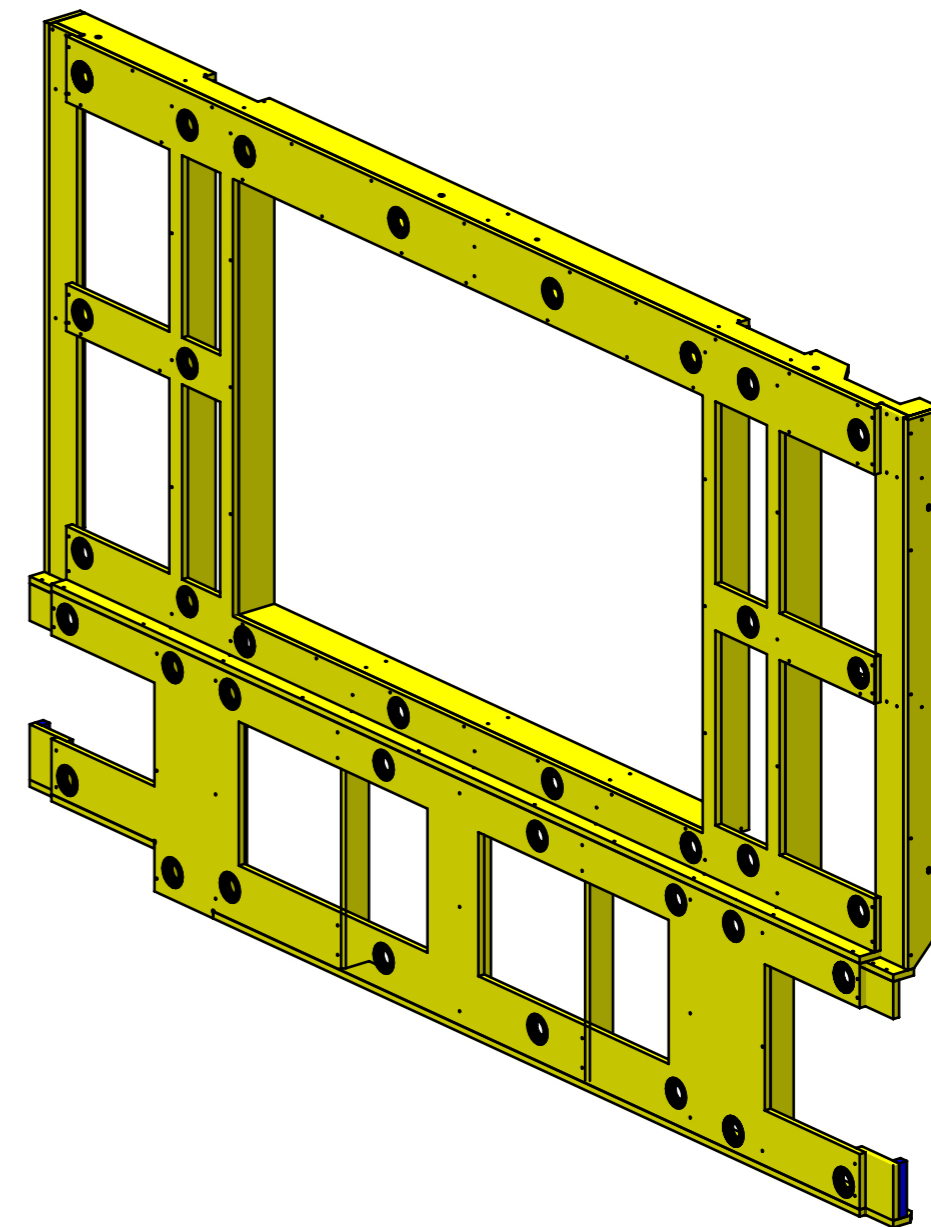
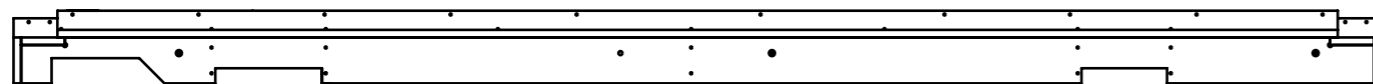

FERRAMENTA	QTY
BUSSOLA 6MA X 10 FORO DIAM.8	3
FITLOCK F_MASCHERPA_6020101102	36

LOCALE	CODICE	DESCRIZIONE COMPONENTE	FINITURA	Q.TA
CABINA VIP SX	MD320_VVB01	COMODINO PRUA	LAMINATO SMART 0180-2 JUNGLE	2

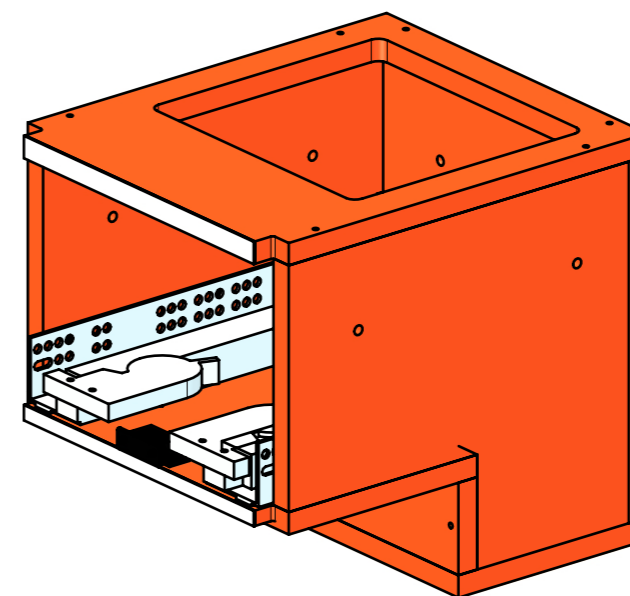
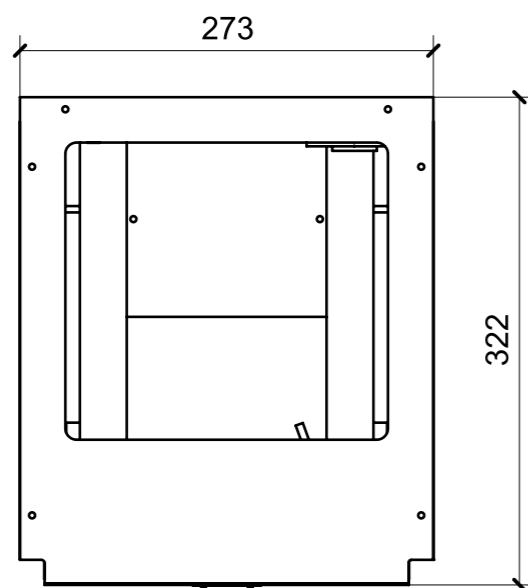
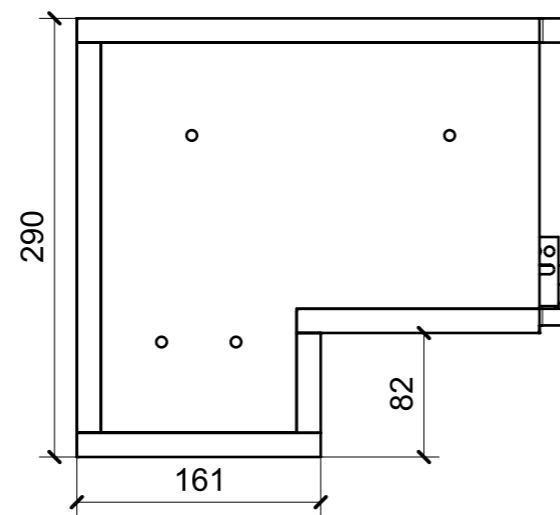
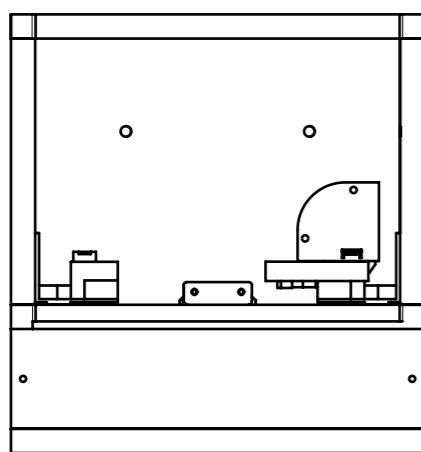

FERRAMENTA	QTY
GUIDA DYNAPRO SOFTCLOSE L300 L_FBC_F130107796 4D	1
GUIDA DYNAPRO ADJUSTMENT ADAPTER L_FBC_F134141746 4D	1
GUIDA DYNAPRO ADJUSTMENT ADAPTER R_FBC_F134141746 4D	1
GUIDA DYNAPRO SOFTCLOSE L300 R_FBC_F130107796 4D	1
GUIDA DYNAPRO FRONT LOCKING DEVICE L_FBC_F134108955 4D	1
GUIDA DYNAPRO FRONT LOCKING DEVICE R_FBC_F134108955 4D	1
PLACCHETTA COUNTER STEEL_TECHNOPARTNER_MC-JM49	1
CALAMITA SEALED MAGNETIC_TECNOPARTNER_MC-JM50-BL	1

LOCALE	CODICE	DESCRIZIONE COMPONENTE	FINITURA	Q.TA
CABINA VIP SX	MD320_VVC01	STRUTTURA LETTO	LAMINATO SMART 0180-2 JUNGLE	PTP

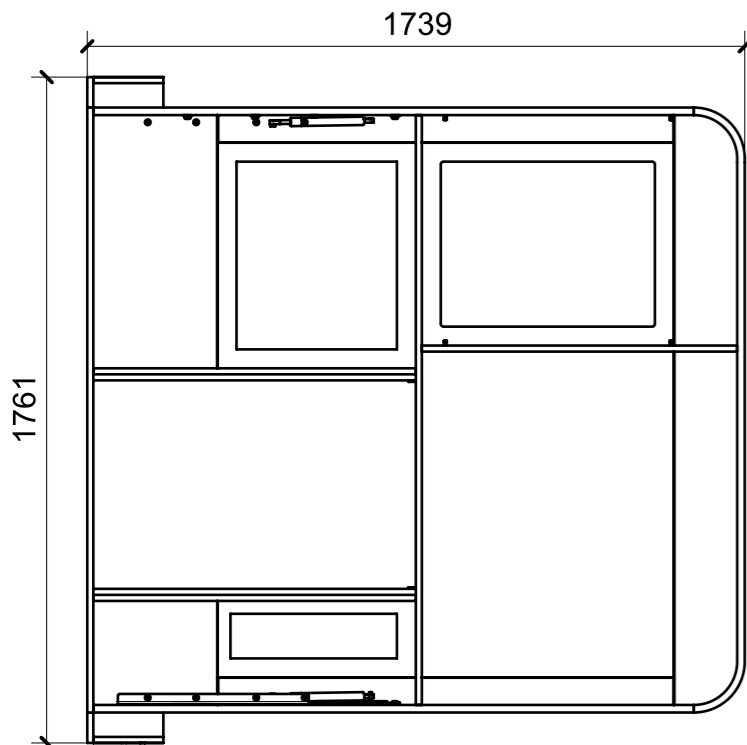

01

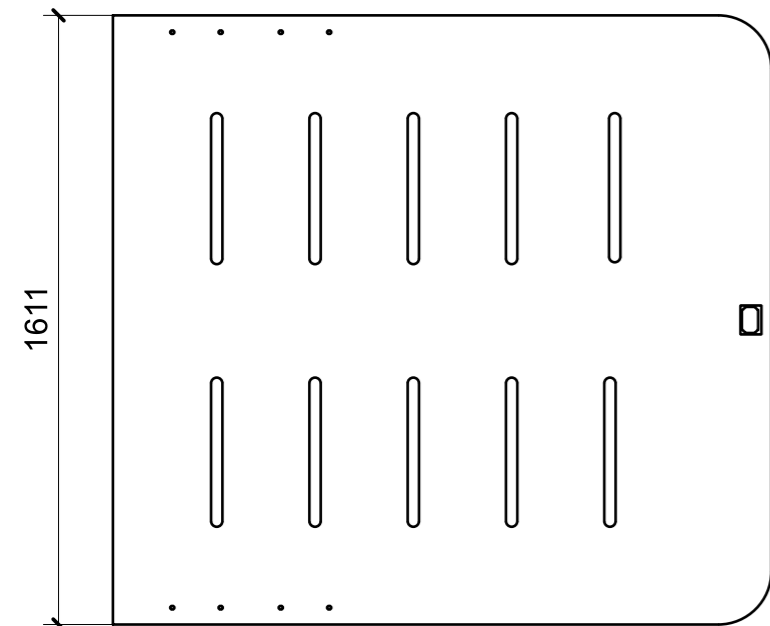

05

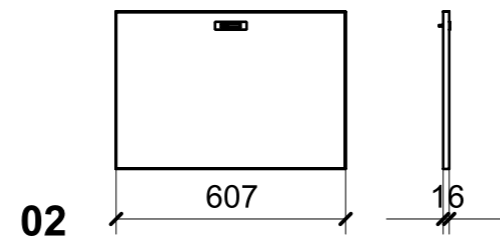

02

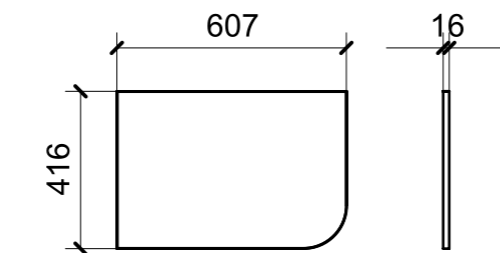

03

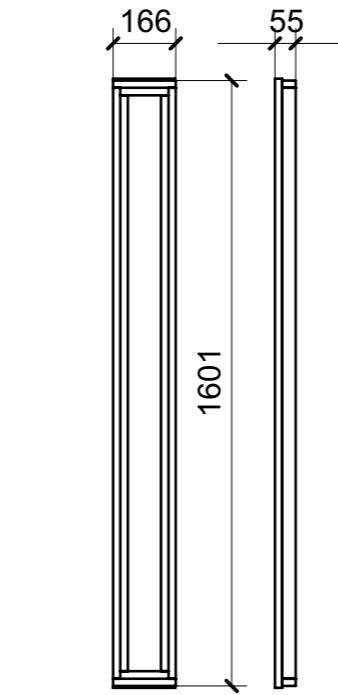

04

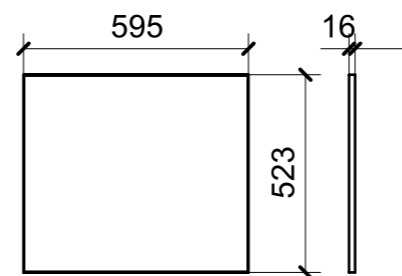

08

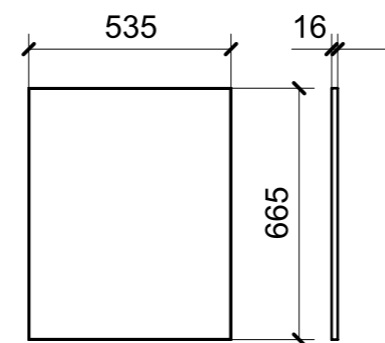

09

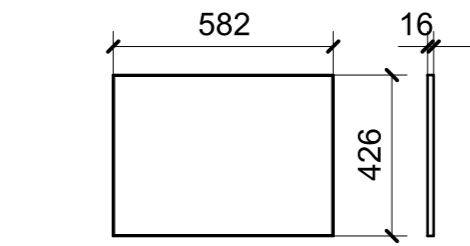

06

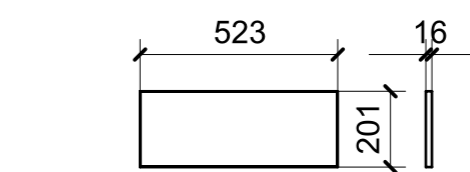

10

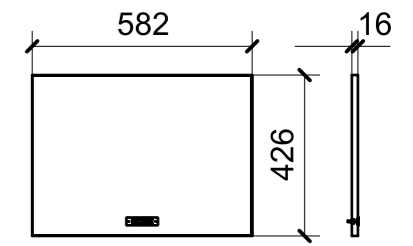

07

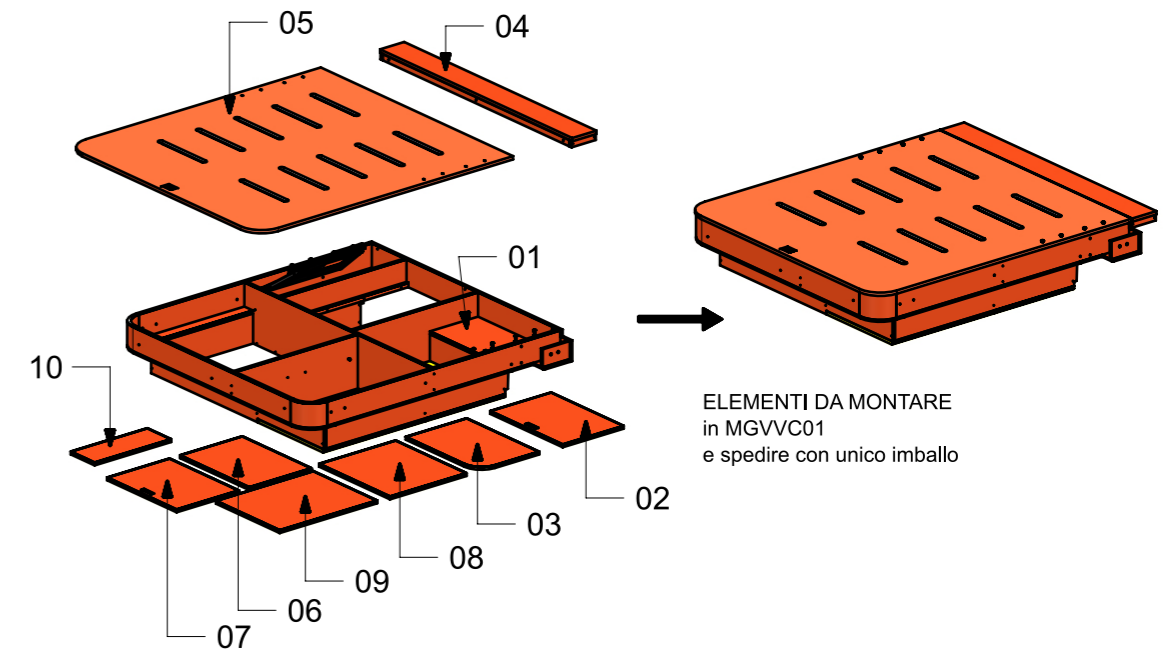

ELEMENTI DA MONTARE  
in MGVC01  
e spedire con unico imballo

FERRAMENTA	QTY
ALZAPAGLIOLI_FORESTI_164.C	2
BORCHIA PASSO 6MA_FBC	8
BUSSOLA 6MA X 10 FORO DIAM.8	4
BUSSOLA 8MA X 14_FBC	8
BUSSOLA RAPIDA_FBC BORGHI_00280877	4
CP TRAPEZI NERI STABILUS TZ 530 BTZ T2.A0_FBC_99999049	1
MANIGLIETTA ALZA LETTO_FORESTI_ART.76A.C	1
PISTONE A GAS STABILUS_456306_600NW-L385_FBC	1
PISTONE A GAS STABILUS_456306_600NW-L385_FBC_99999049	1
RANELLA SP.2 MM DIAM.24 FORO 8_FBC	8
REGGIRIPIANO PERNO RAPIDO X CR. CO-RING_FBC BORGHI_00073653	4
SEEGER PER MECC. LETTO_00407908	2
TBL 6MAX15_FBC	8
TBL 8MA X 20_FBC	8

LOCALE	CODICE	DESCRIZIONE COMPONENTE	FINITURA	Q.TA
CABINA VIP SX	MD320_VVD01	COMODINO POPPA	LAMINATO SMART 0180-2 JUNGLE	2

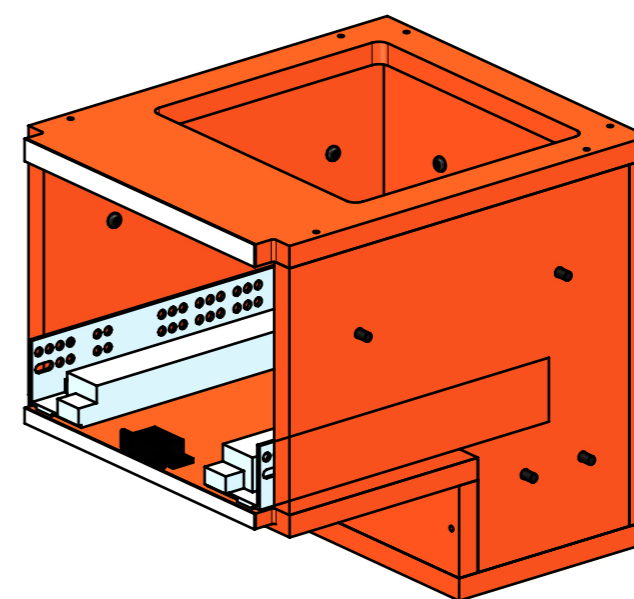
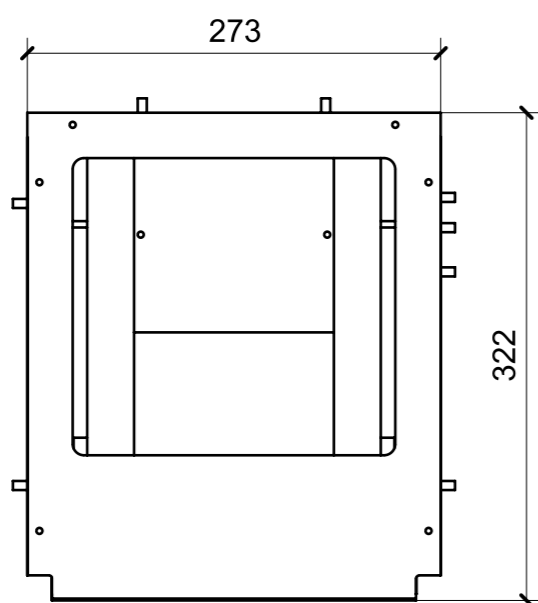
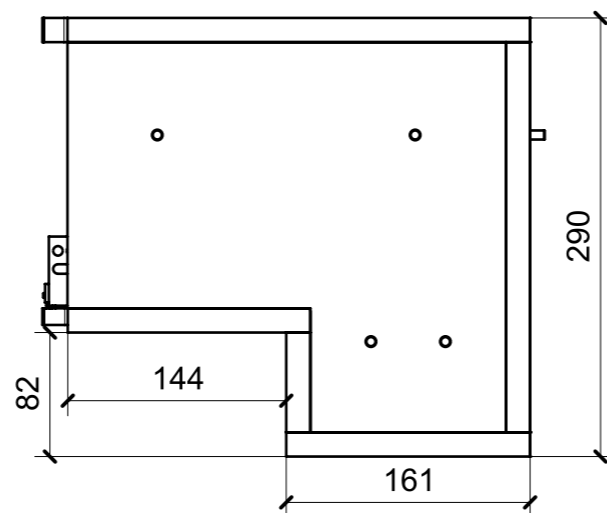
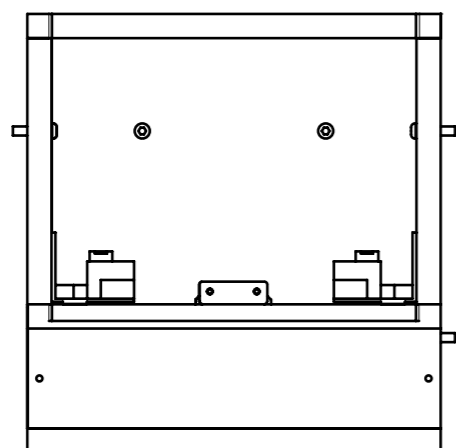

FERRAMENTA	QTY
GUIDA DYNAPRO SOFTCLOSE L300 R_FBC_F130107796 4D	1
GUIDA DYNAPRO SOFTCLOSE L300 L_FBC_F130107796 4D	1
VITE 6MA X 25 TESTA BOMBATA NERA BHCS 10.9 ISO 7380	8
PLACCHETTA COUNTER STEEL_TECHNOPARTNER_MC-JM49	1
CALAMITA SEALED MAGNETIC_TECNOPARTNER_MC-JM50-BL	1

LOCALE	CODICE	DESCRIZIONE COMPONENTE	FINITURA	GR.
CABINA VIP SX	MD320_VVH01	CORNICE TV	OKUME' GREZZO/GREZZO SPRUZZATO NERO/EULITE	2

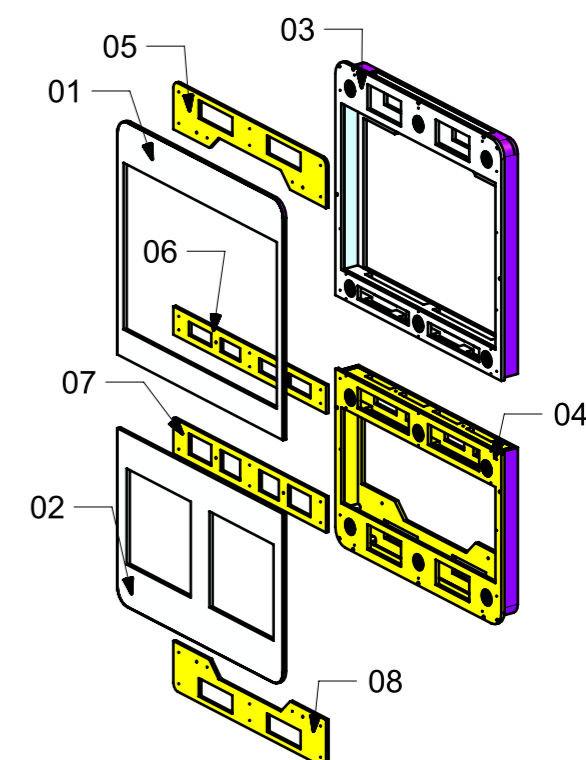
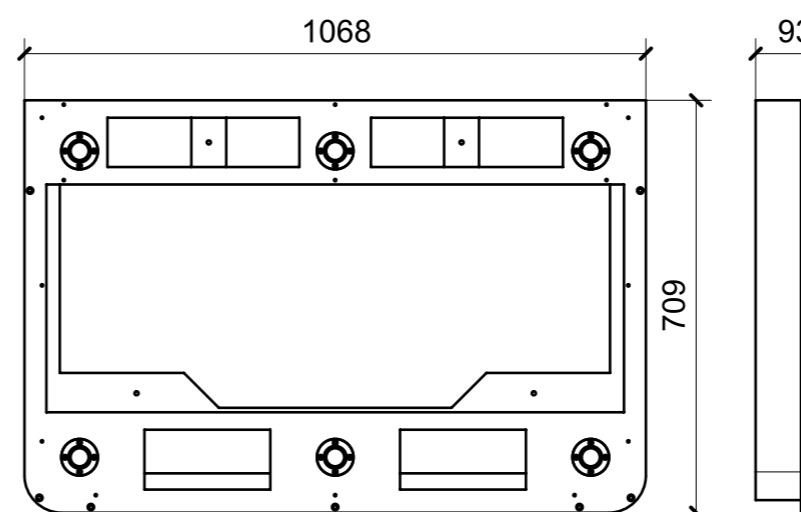
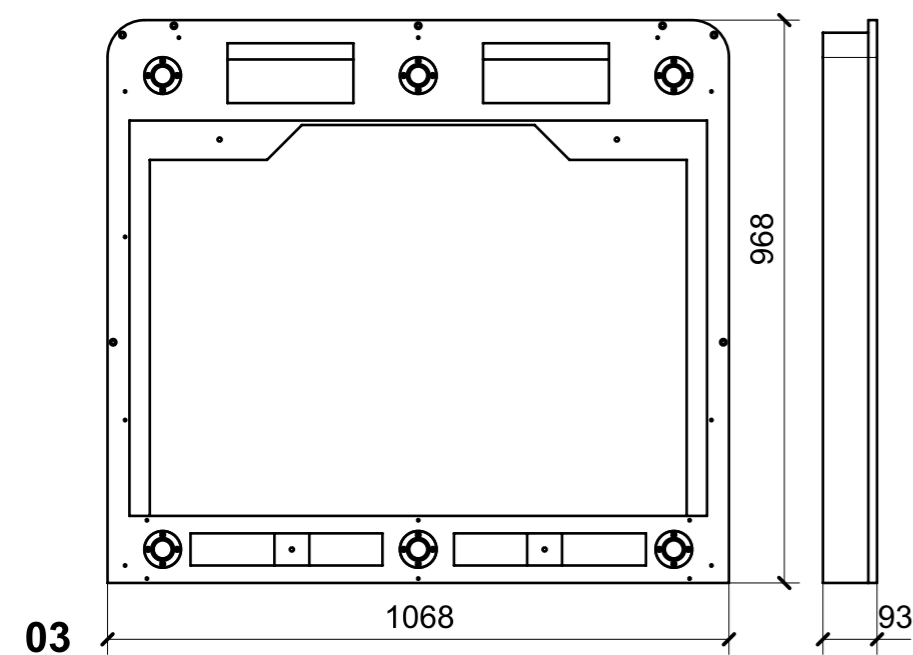
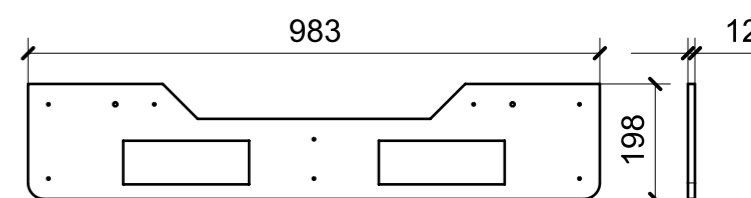
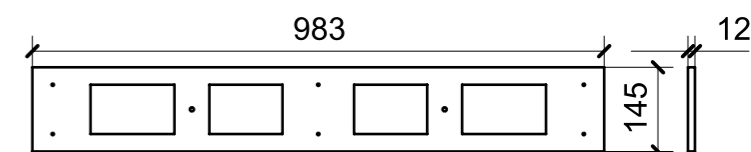
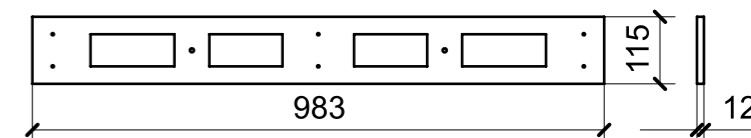
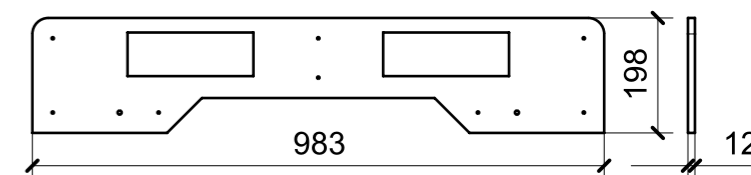
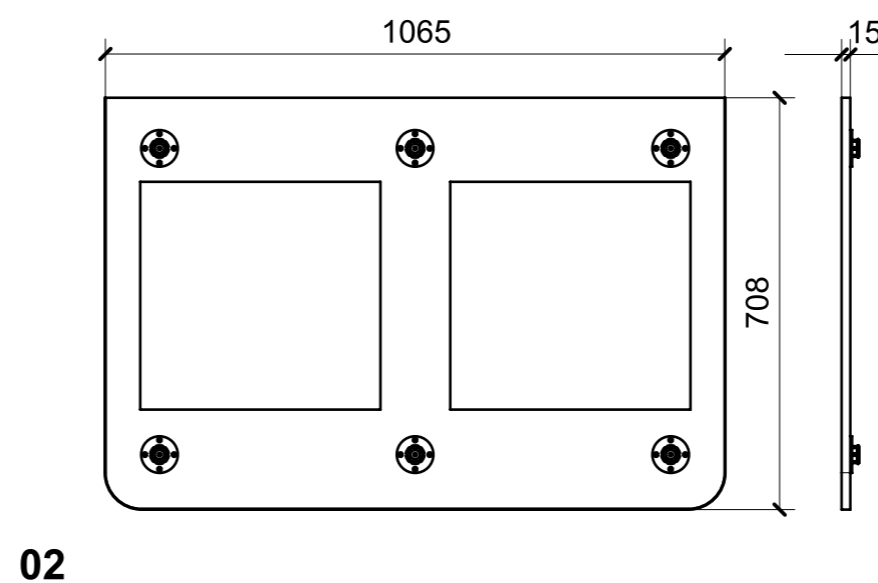
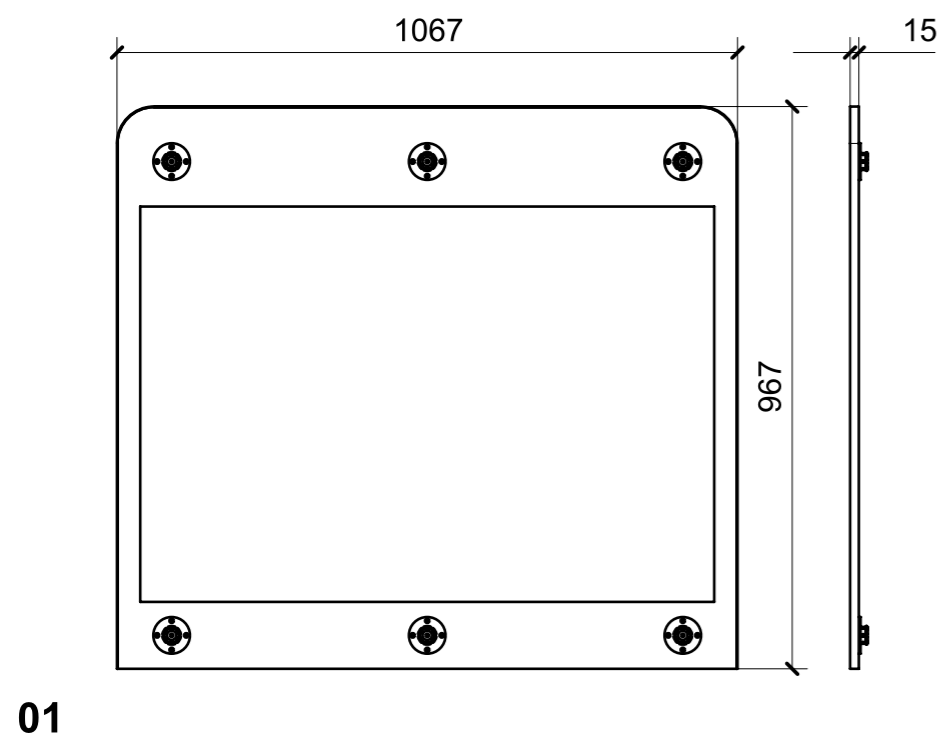

FERRAMENTA	QTY
FITLOCK M_MASCHERPA_3MM_6020202101	12
BUSSOLA 6MA X 10 FORO DIAM.8	2
FITLOCK F_MASCHERPA_6020101102	12

LOCALE	CODICE	DESCRIZIONE COMPONENTE	FINITURA	GR.
CABINA VIP SX	MD320_VVI01	ARMADIO	LAMINATO SMART 0180-2 JUNGLE	2

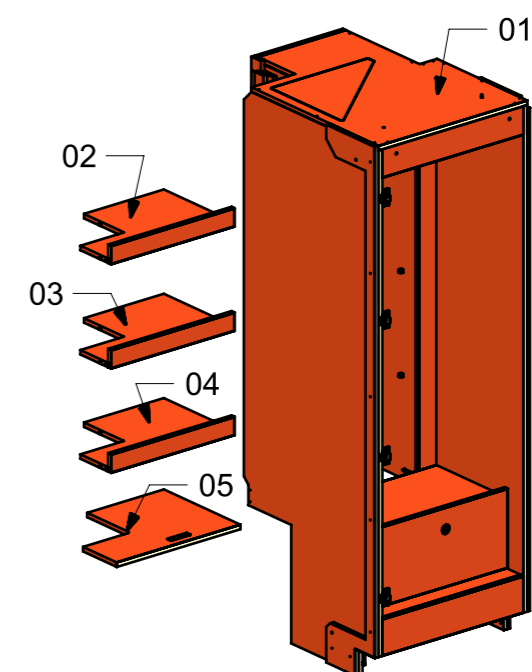
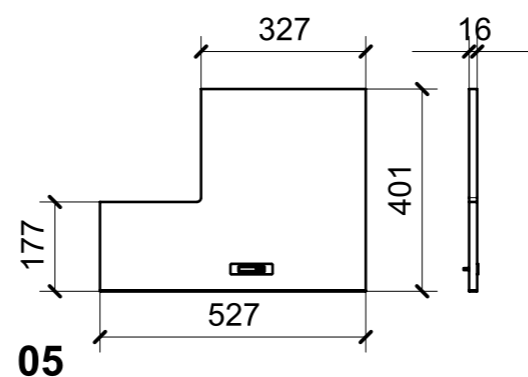
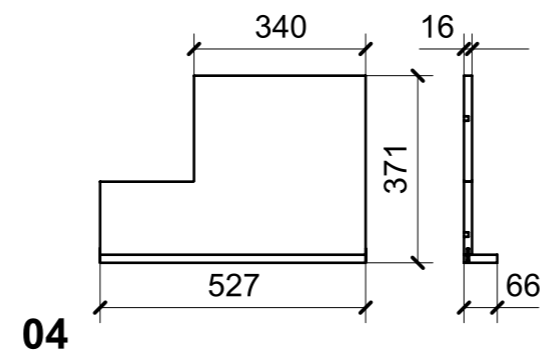
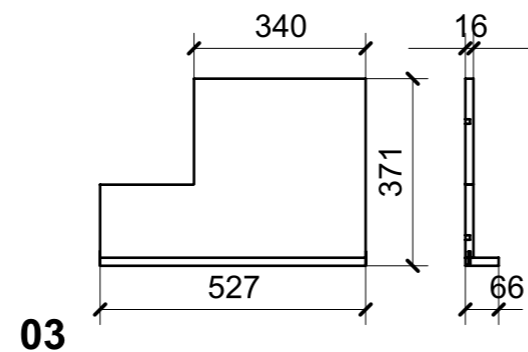
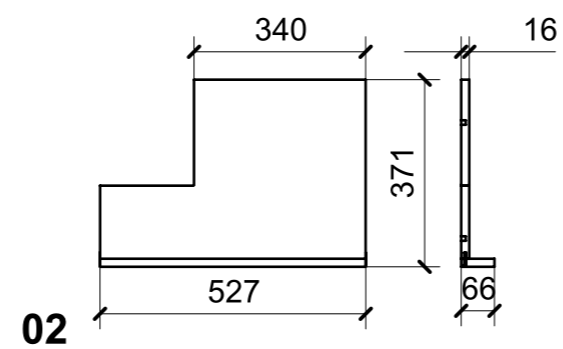
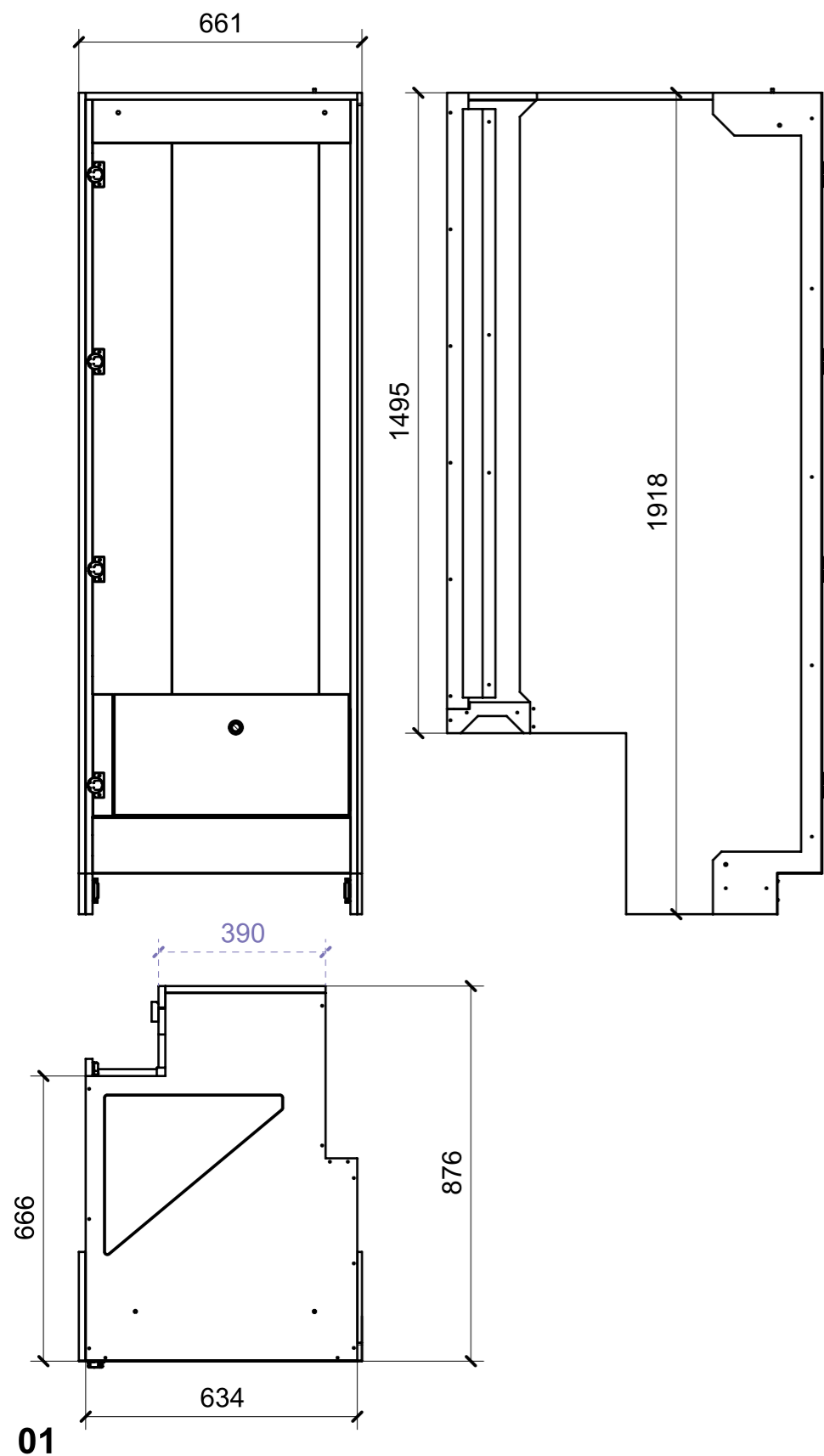

FERRAMENTA	QTY
KIT LED PER ARMADIO MD320 VI01-VVI01 MM 600_	1
GUIDA DYNAPRO ADJUSTAMENT ADAPTER L_FBC_F134141746 4D	1
GUIDA DYNAPRO FRONT LOCKING DEVICE R_FBC_F134108955 4D	1
GUIDA DYNAPRO SOFTCLOSE L300 L_FBC_F130107796 4D	1
GUIDA DYNAPRO ADJUSTAMENT ADAPTER R_FBC_F134141746 4D	1
GUIDA DYNAPRO FRONT LOCKING DEVICE L_FBC_F134108955 4D	1
GUIDA DYNAPRO SOFTCLOSE L300 R_FBC_F130107796 4D	1
ALZAPAGLIOLI_FORESTI_164.C	1
BASE_0-NERA_HAFELE_342.22.065-BLUM_175H3100.STP	4
BUSSOLA 5MA ANKOR BORGHI X BASE 0	8
BUSSOLA 5MA ANKOR BORGHI X CERNIERA PIANA	8
BUSSOLA 6MA X 10 FORO DIAM.8	10
CERNIERA 94°_PIANA-NERA_HAFELE_342.46.604-BLUM_71B9550.STP	4
CHIUSURA A SPINTA_TECHNOPARTNER_SOU C3-203	8
COPERTURA BRACCIO CERNIERA NERO-HAFELE_342.94.602-BLUM_70.1503.STP	4
COPERTURA GABBIA CERNIERA NERO_HAFE_342.45.032-BLUM_70T3504.STP	4
GIUNTO REGGIRIPIANO CON BORDO ANTISGANCIO_FBC BORGHI_1033XXB060902	12
KEEPER PUSH TO CLOSE_SOUTCHO-J-M1-519-4_TECHNOPARTNER	1
PERNO LISCIO PER SPALLA_FBC BORGHI_1033PXX050531	12
PUSH TO CLOSE_SOUTHCO-MP-05-312-55 NERA_TECHNOPARTNER	1
VITE 4MAX8 ANKOR BORGHI X BASE 0	8
VITE 4MAX8 ANKOR BORGHI X CERNIERA PIANA	8
VITE 6MA X 25 TESTA SVASATA	4
VITE 6MA X 25 TESTA BOMBATA DIN	7

LOCALE	CODICE	DESCRIZIONE COMPONENTE	FINITURA	Q.TA
CABINA VIP SX	MD320_VVL01	PLENUM ARMADIO	VERNICIATO ANTI ROMBO	PTP

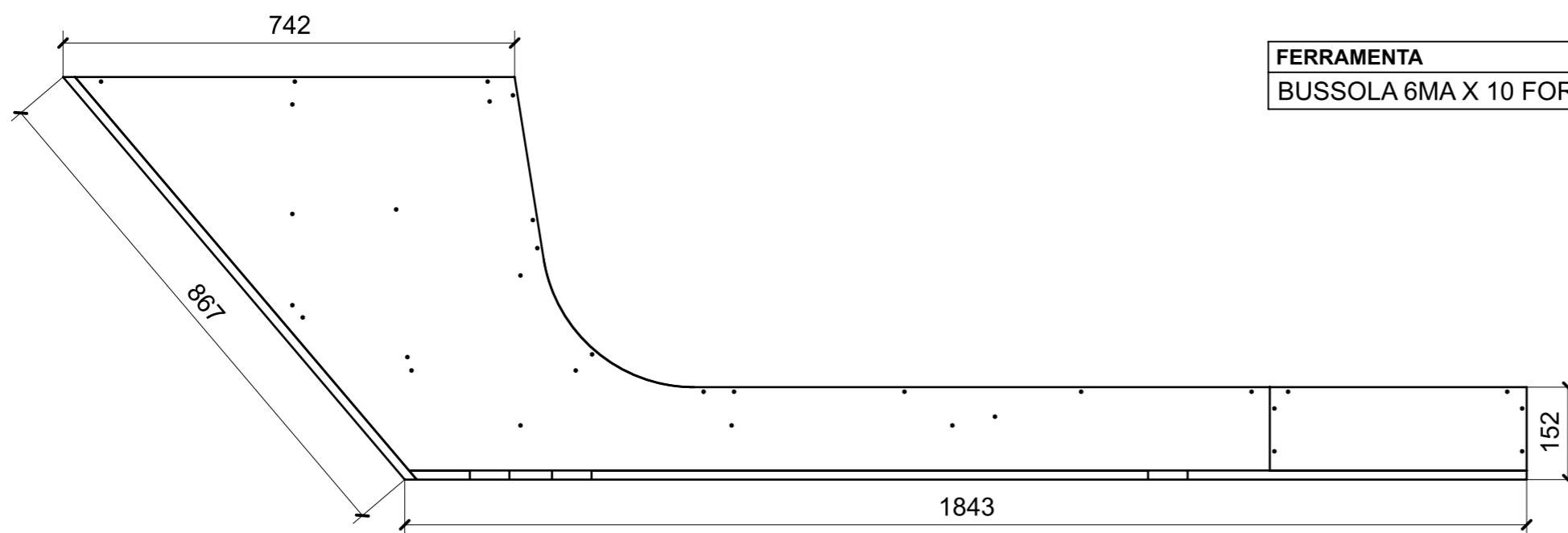
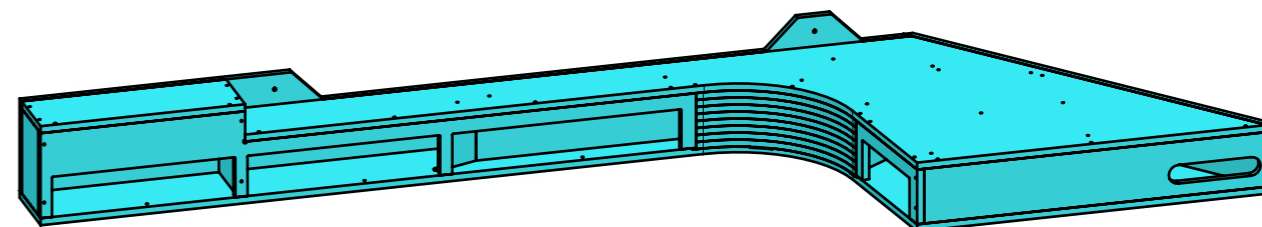

FERRAMENTA	QTY
BUSSOLA 6MA X 10 FORO DIAM.8	2

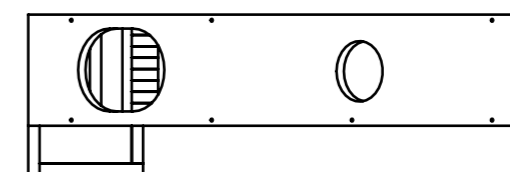
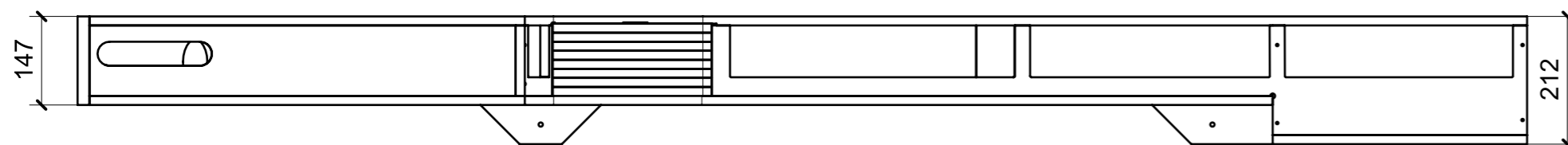

LOCALE	CODICE	DESCRIZIONE COMPONENTE	FINITURA	GR
CABINA VIP SX	MD320_VVO01	CIELINO	CARTA MELAMINICA NERA	2

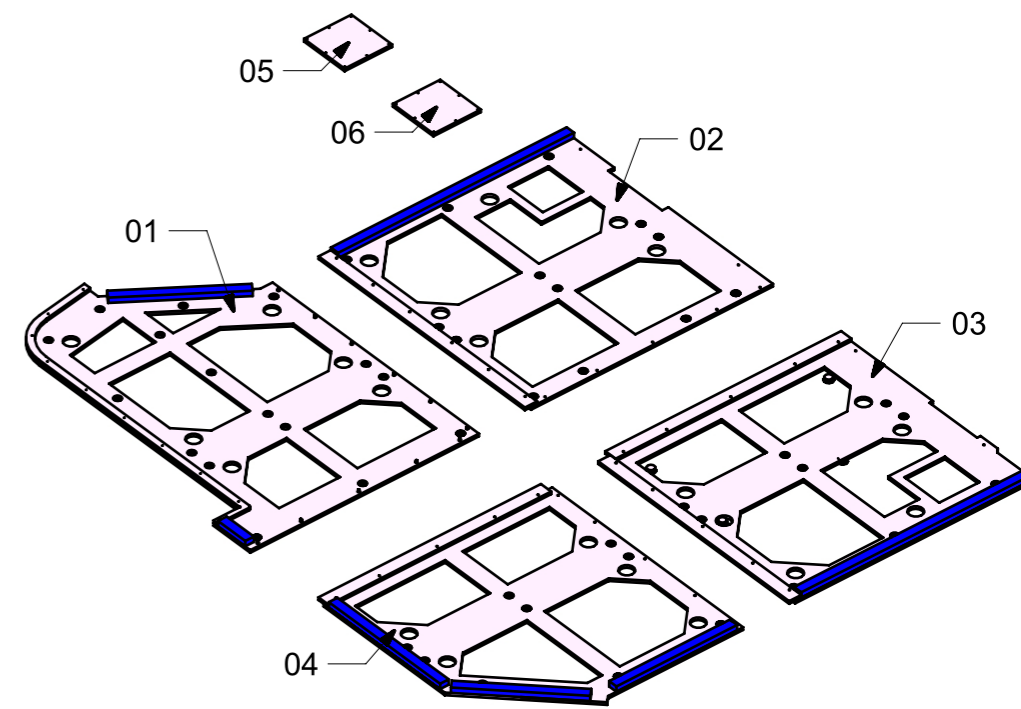
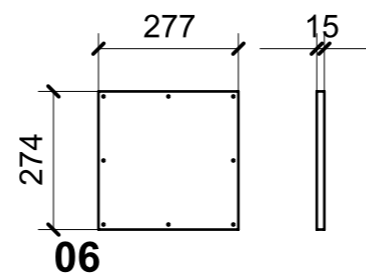
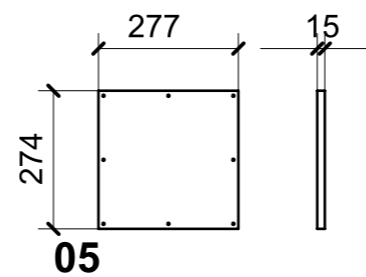
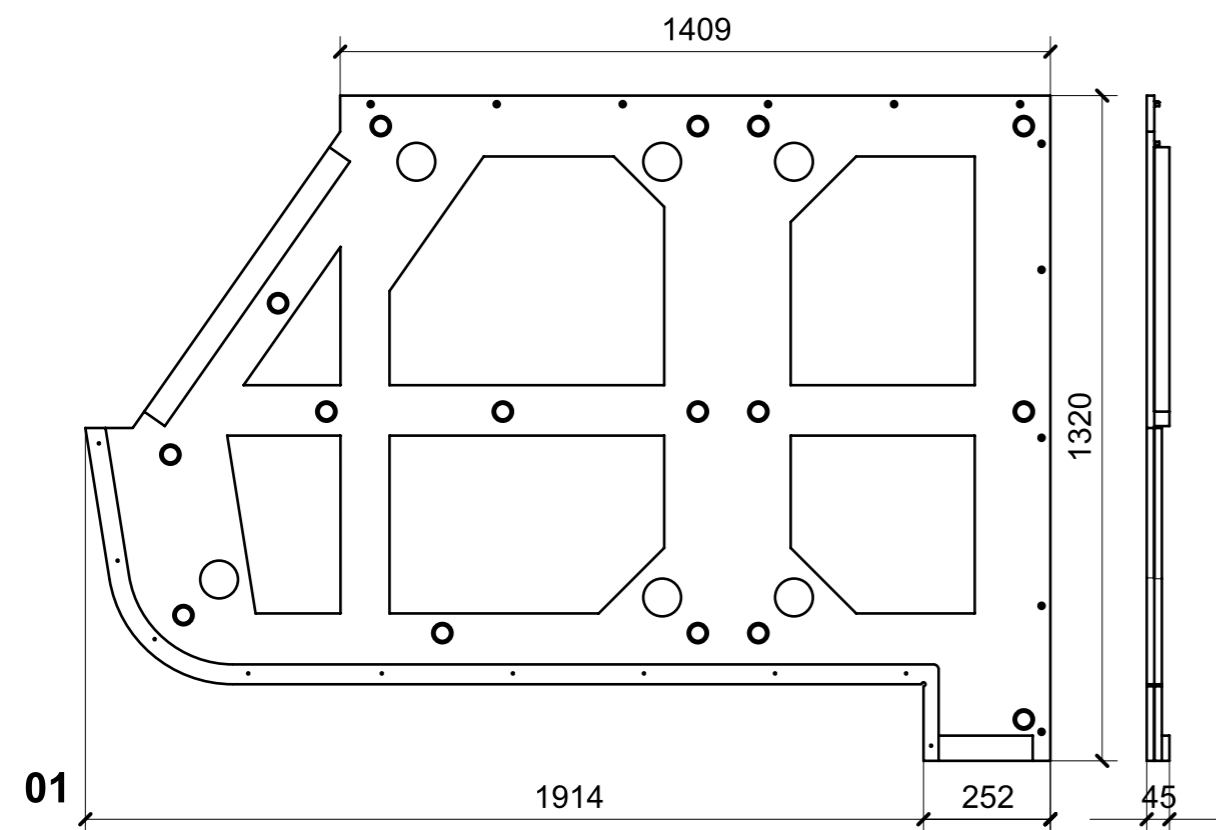
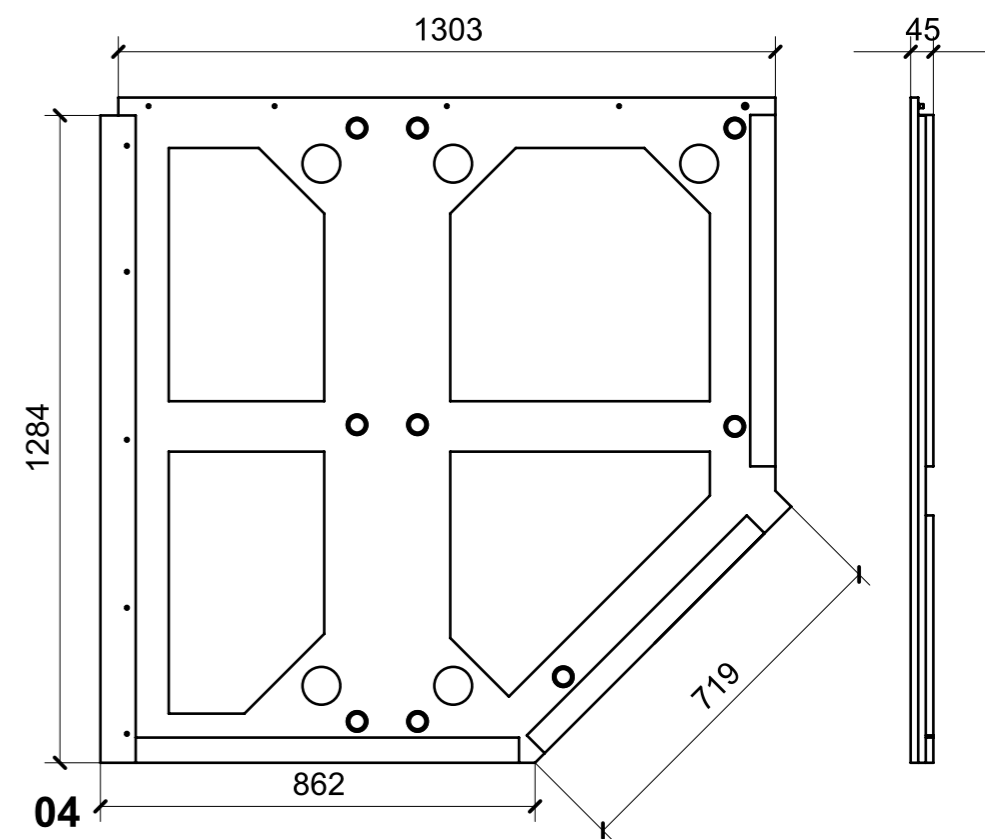
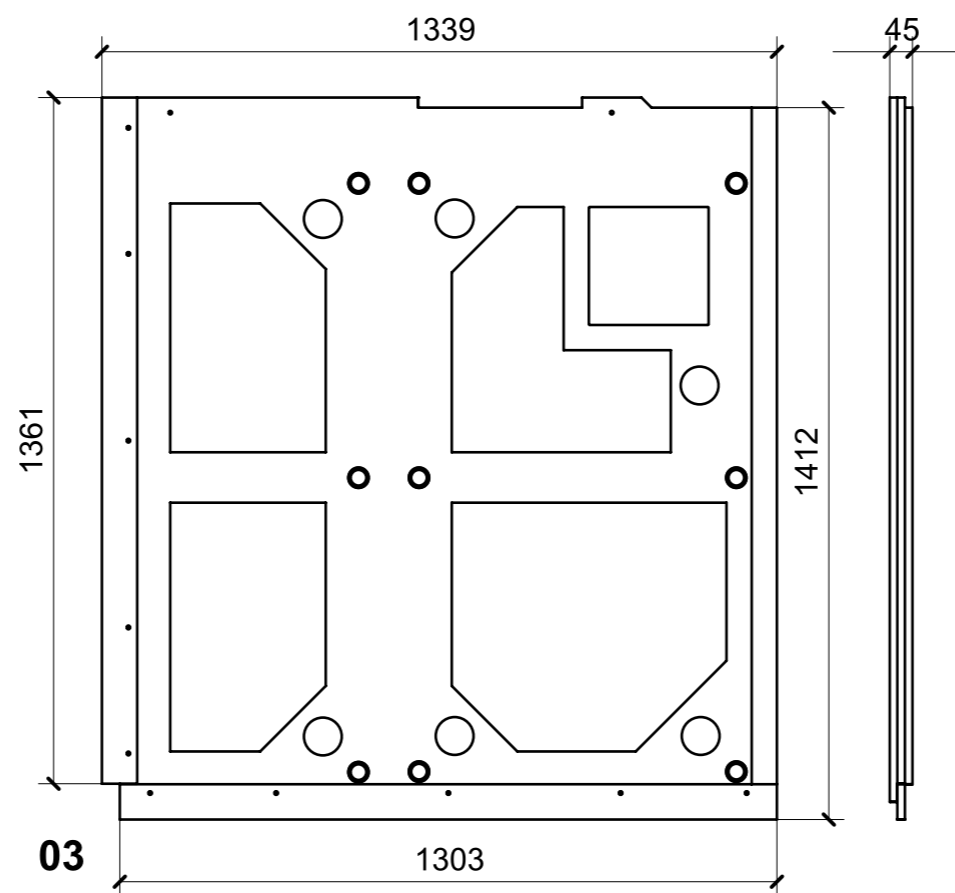
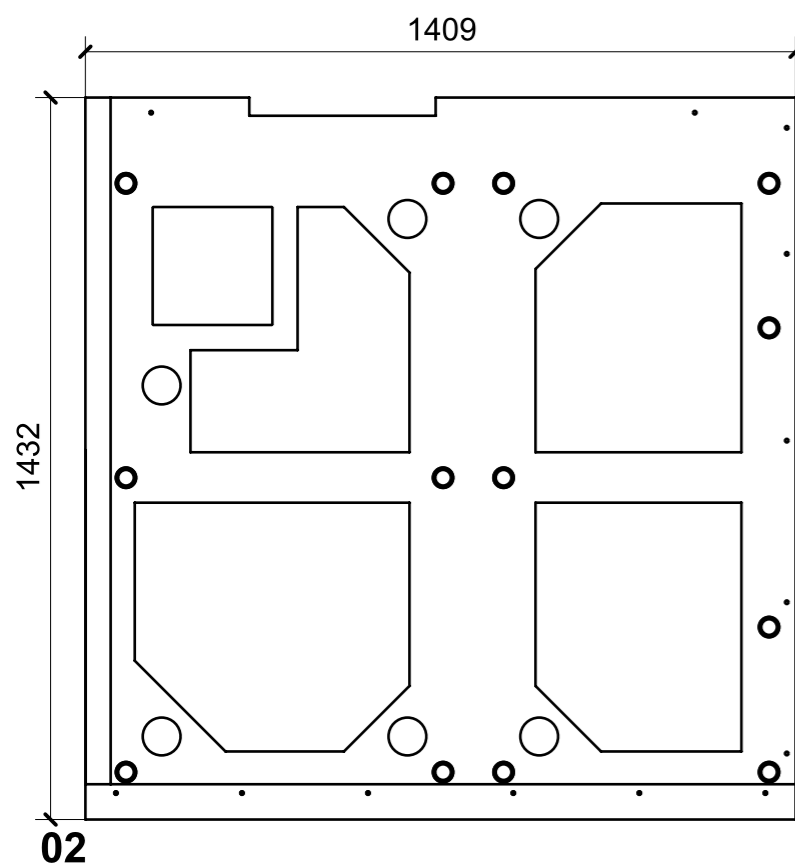

FERRAMENTA	QTY
BUSSOLA 6MA X 10 FORO DIAM.8	55
FITLOCK F_MASCHERPA_6020101102	47