

LOCALE	CODICE	DESCRIZIONE COMPONENTE	FINITURA	GR.
CABINA OSPITI DX	MD320_R02_RA01	STRUTTURA MURATA TESTATA LETTO	LASTRA CHIARA	2

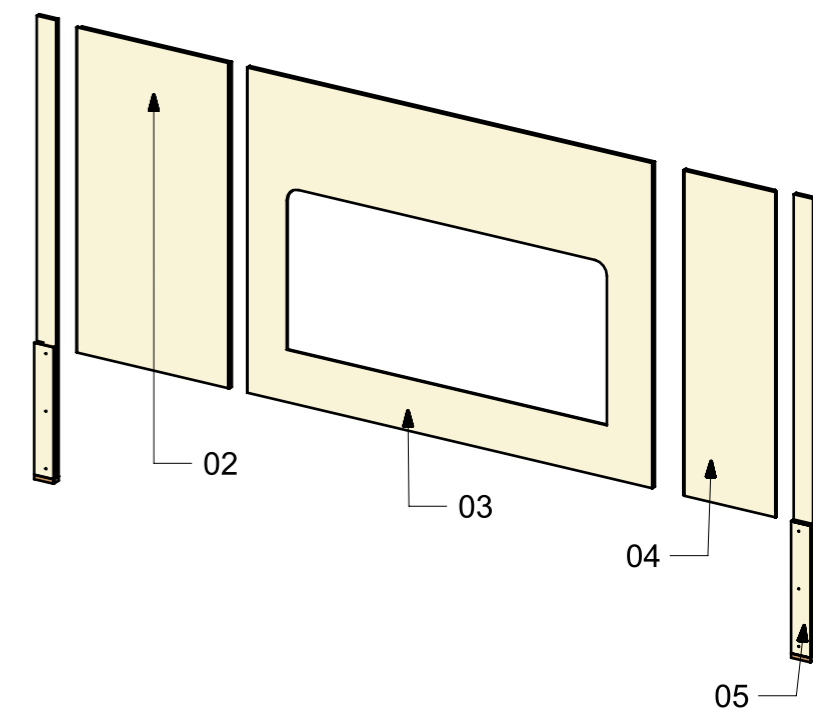
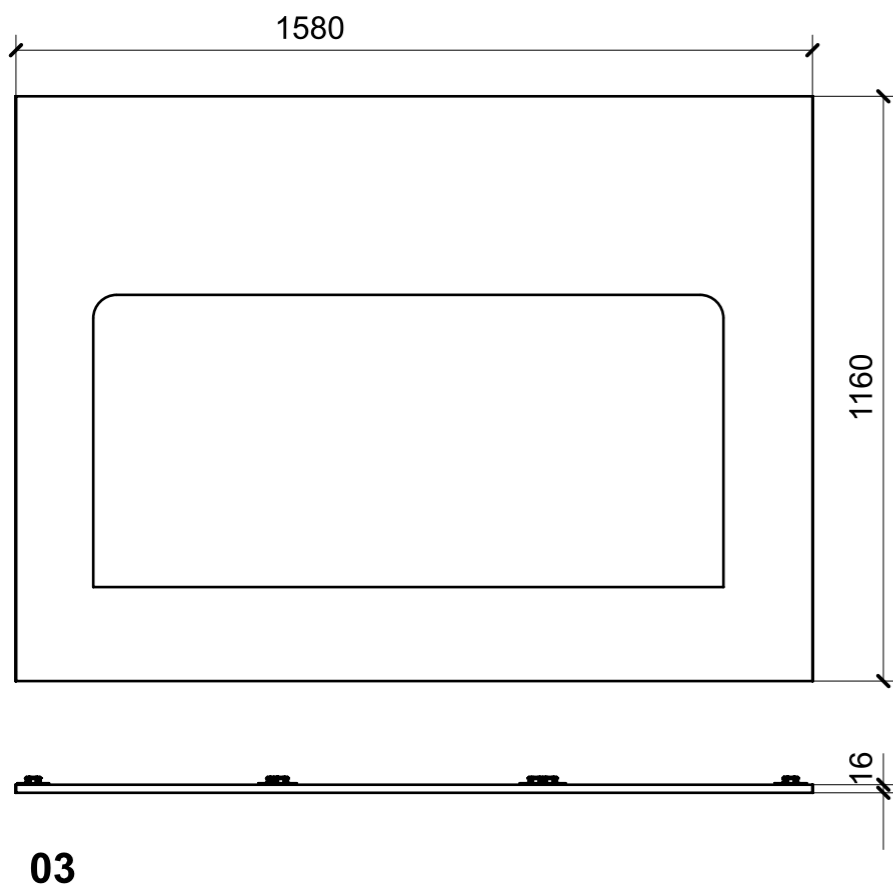
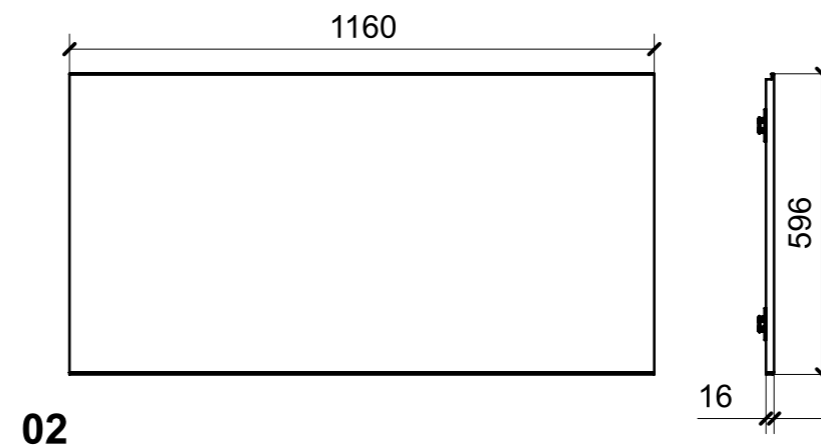
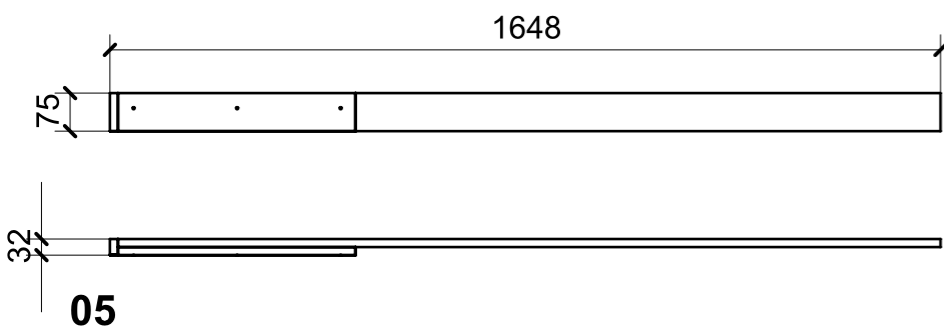
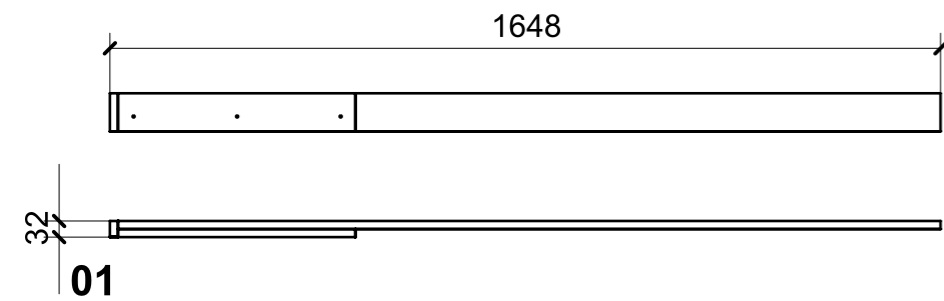

FERRAMENTA	QTY
FITLOCK M_MASCHERPA_3MM_6020202101	16

VERNICIATURA LASTRA/LACCATI:

● = VERNICIARE 1 LATO + FILI RASATI O BORDATI

NESSUN SIMBOLO = VERNICIARE 2 LATI + FILI RASATI O BORDATI

LOCALE	CODICE	DESCRIZIONE COMPONENTE	FINITURA	GR.
CABINA OSPITI DX	MD320_R01_RE01	RIV. PARETE CENTRO NAVE	LASTRA SCURA	2

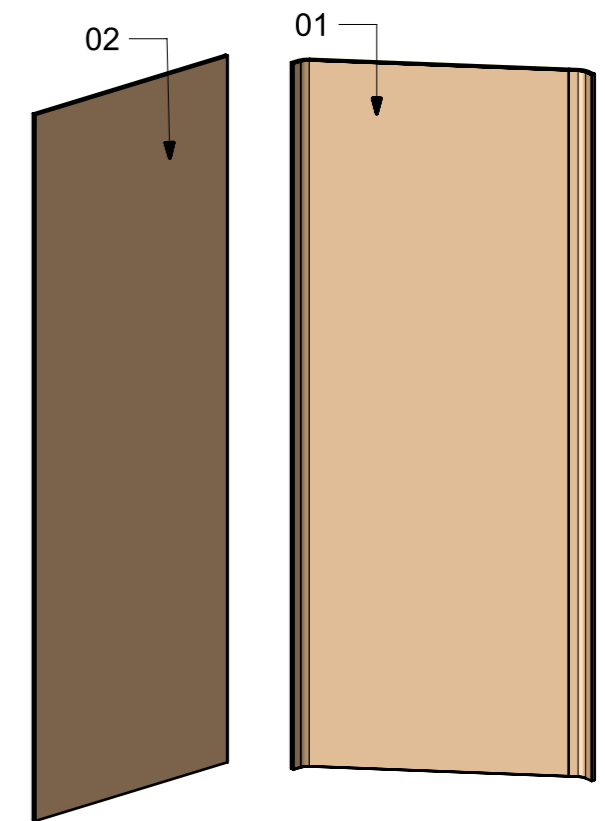
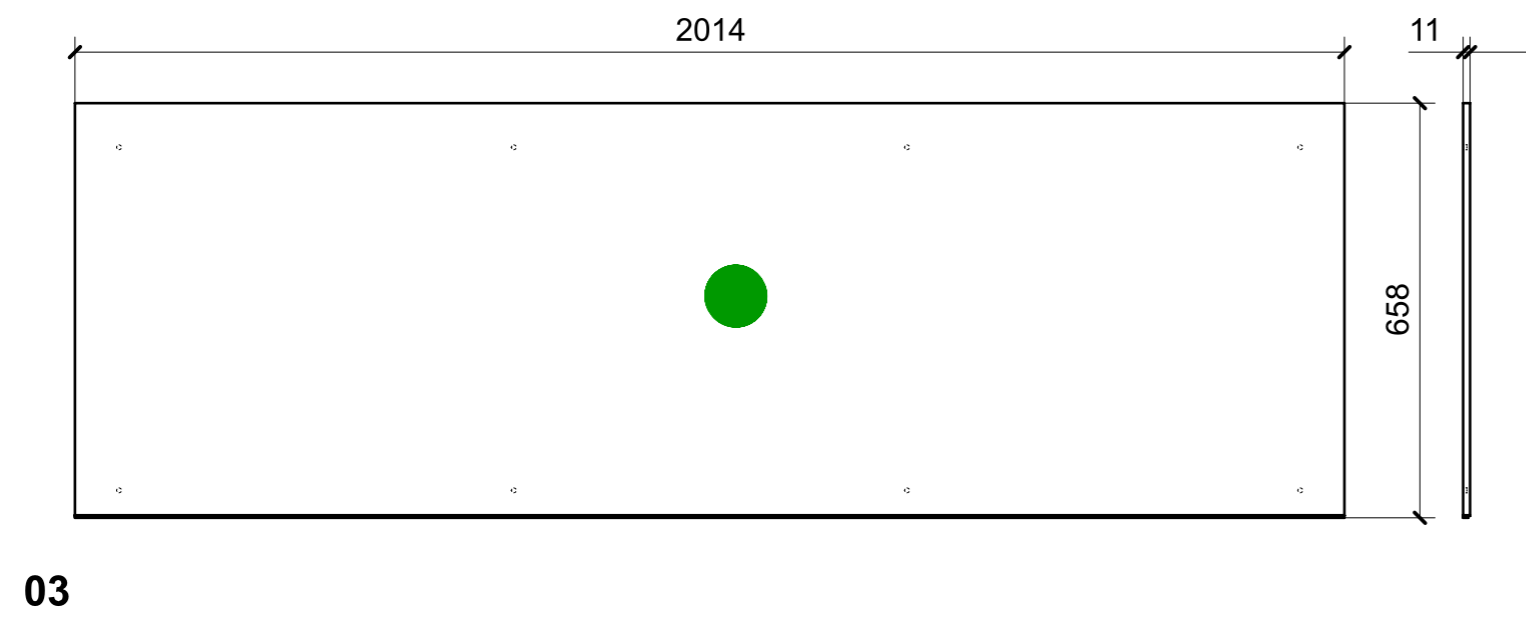
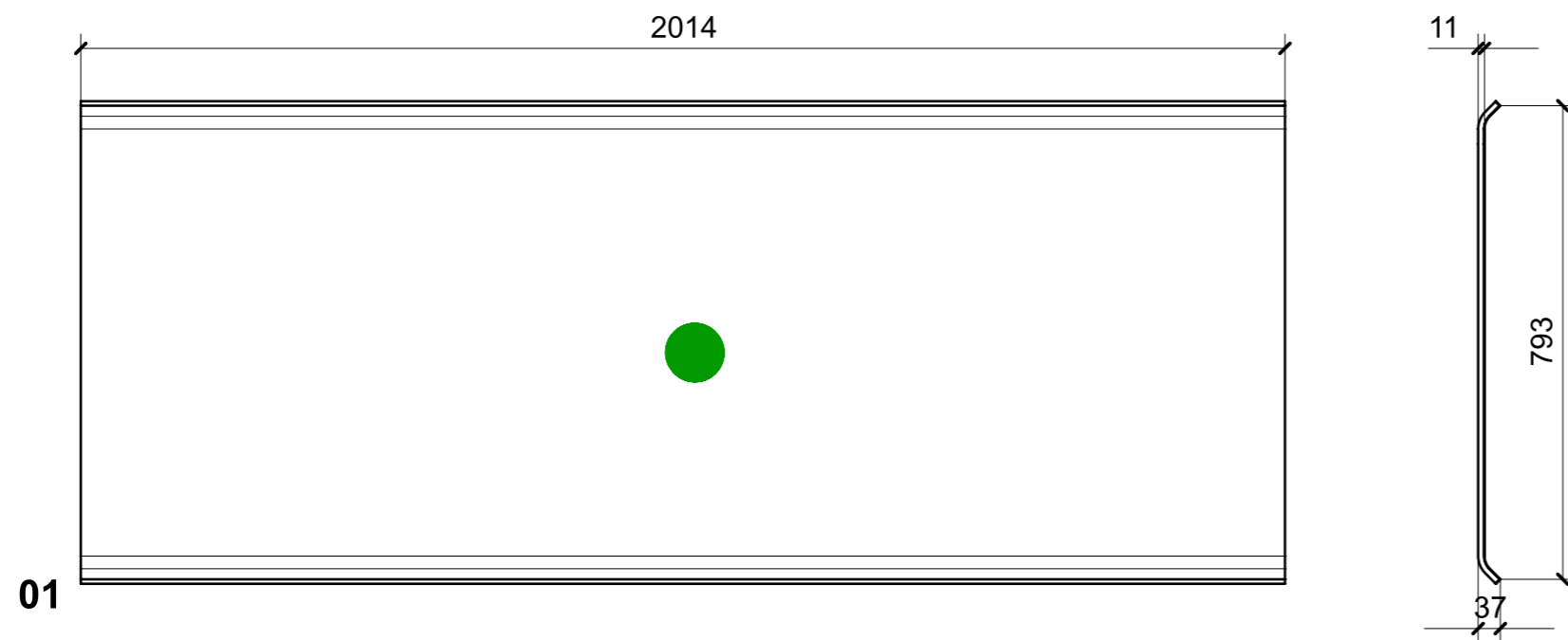

VERNICIATURA LASTRA/LACCATI:  
 ● = VERNICIARE 1 LATO + FILI RASATI O BORDATI      NESSUN SIMBOLO = VERNICIARE 2 LATI + FILI RASATI O BORDATI

LOCALE	CODICE	DESCRIZIONE COMPONENTE	FINITURA	GR.
CABINA OSPITI DX	MD320_R02_RE01	RIV. PARETE CENTRO NAVE	LASTRA CHIARA	2

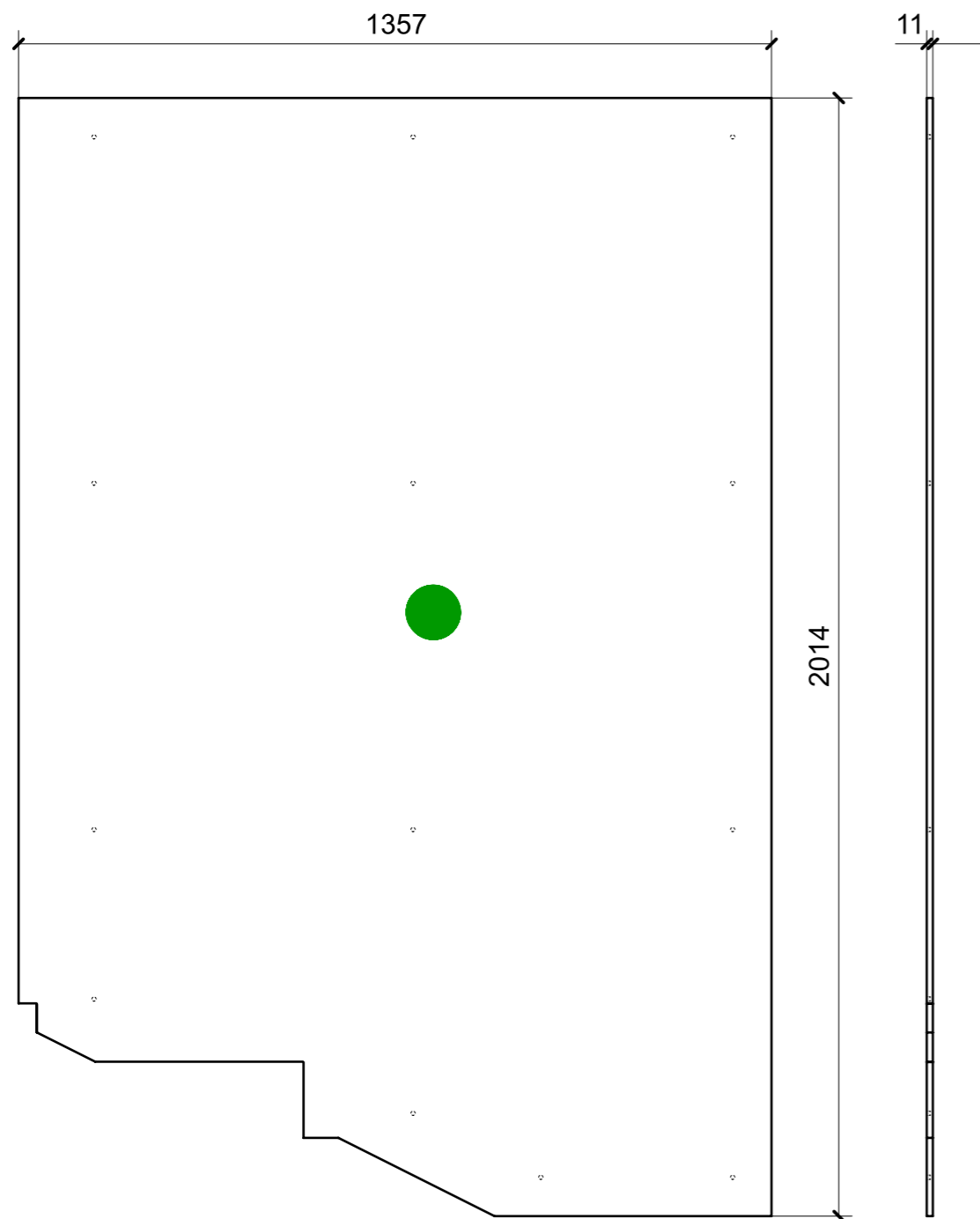

VERNICIATURA LASTRA/LACCATI:

● = VERNICIARE 1 LATO + FILI RASATI O BORDATI

NESSUN SIMBOLO = VERNICIARE 2 LATI + FILI RASATI O BORDATI

LOCALE	CODICE	DESCRIZIONE COMPONENTE	FINITURA	GR.
CABINA OSPITI DX	MD320_R01_RF01	RIV. PARETE CENTRO NAVE	LASTRA SCURA	2

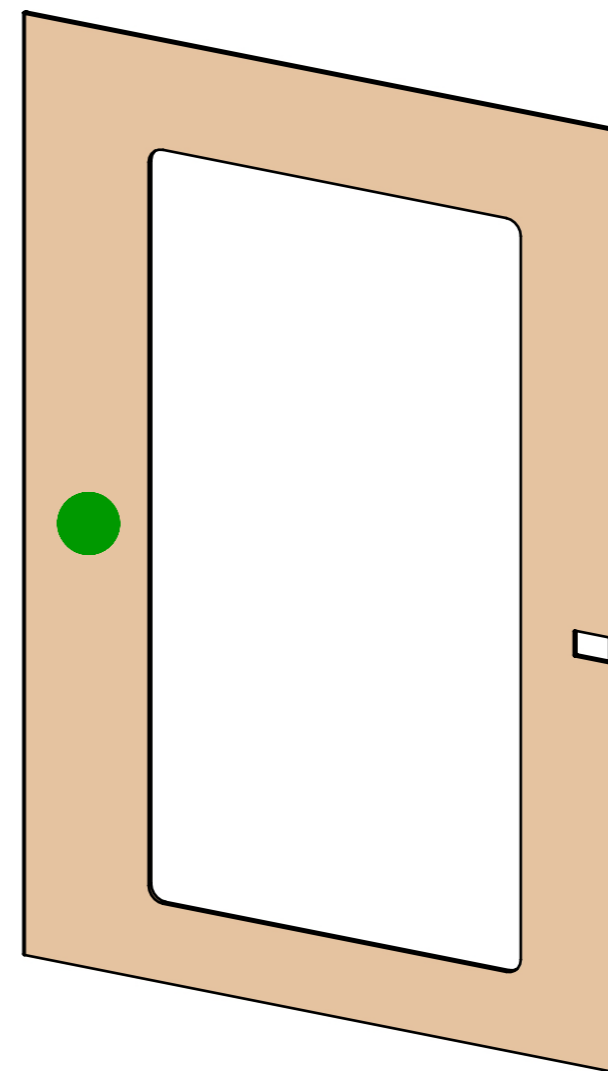
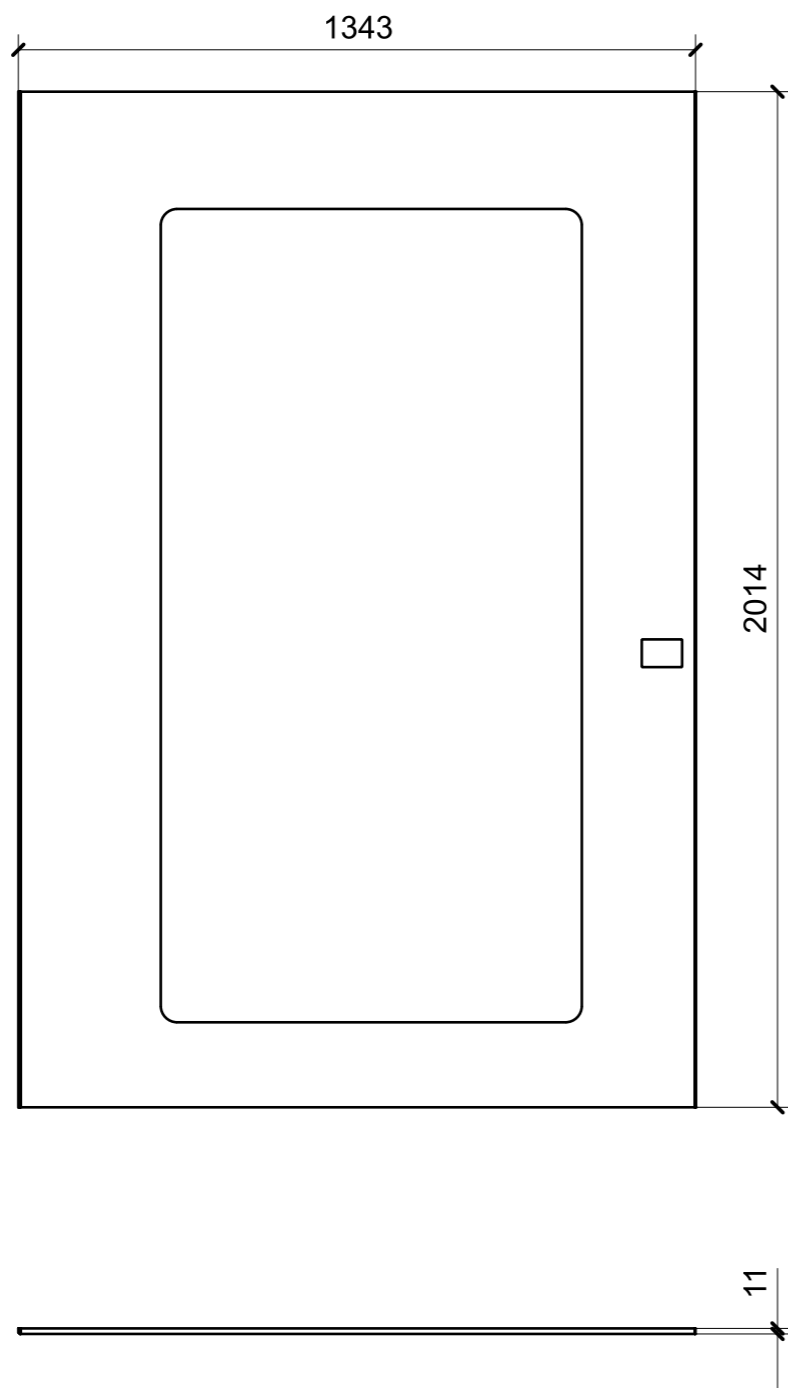

VERNICIATURA LASTRA/LACCATI:

● = VERNICIARE 1 LATO + FILI RASATI O BORDATI

NESSUN SIMBOLO = VERNICIARE 2 LATI + FILI RASATI O BORDATI

LOCALE	CODICE	DESCRIZIONE COMPONENTE	FINITURA	GR.
CABINA OSPITI DX	MD320_R01_RG01	RIV. PARETE PRUA	LASTRA SCURA	PTP

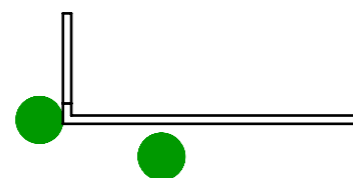
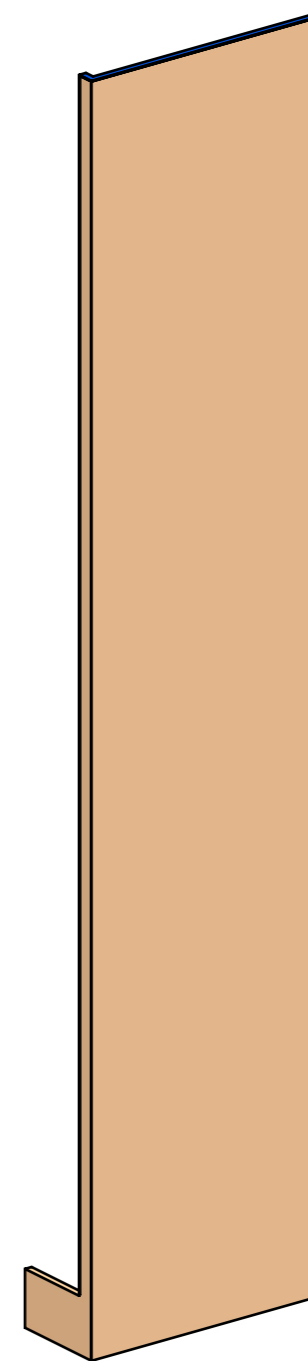
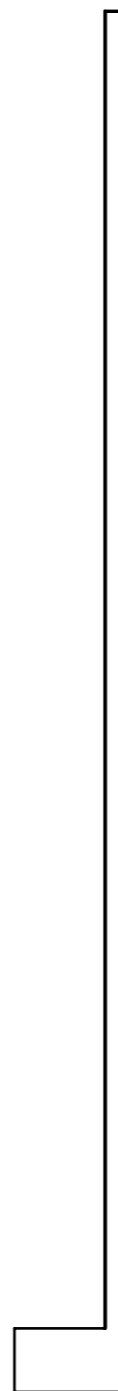
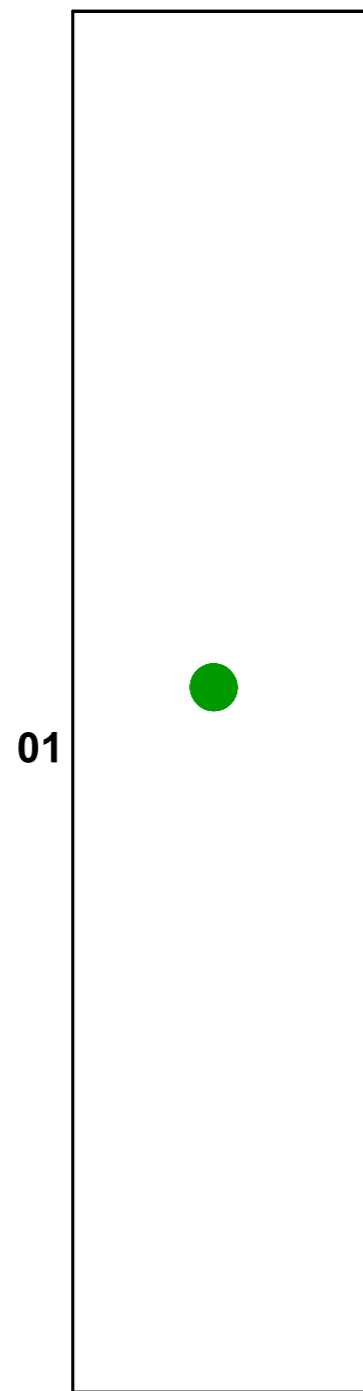

VERNICIATURA LASTRA/LACCATI:

● = VERNICIARE 1 LATO + FILI RASATI O BORDATI

NESSUN SIMBOLO = VERNICIARE 2 LATI + FILI RASATI O BORDATI

LOCALE	CODICE	DESCRIZIONE COMPONENTE	FINITURA	GR.
CABINA OSPITI DX	MD320_R02_RG01	RIV. PARETE PRUA	LASTRA CHIARA	PTP

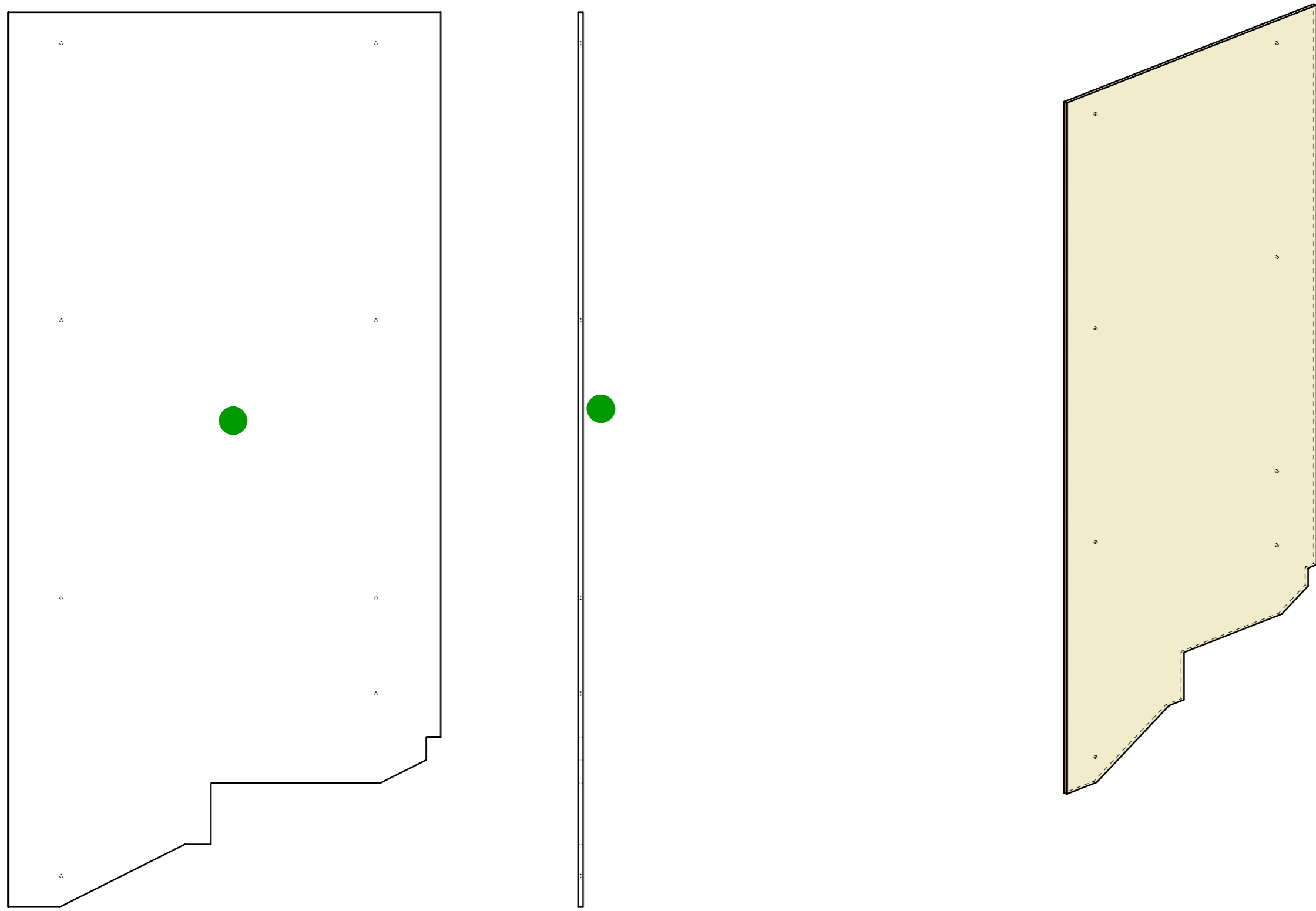

VERNICIATURA LASTRA/LACCATI:

● = VERNICIARE 1 LATO + FILI RASATI O BORDATI

NESSUN SIMBOLO = VERNICIARE 2 LATI + FILI RASATI O BORDATI

LOCALE	CODICE	DESCRIZIONE COMPONENTE	FINITURA	GR.
CABINA OSPITI DX	MD320_R01_RI01	ARMADIO	LASTRA SCURA	2

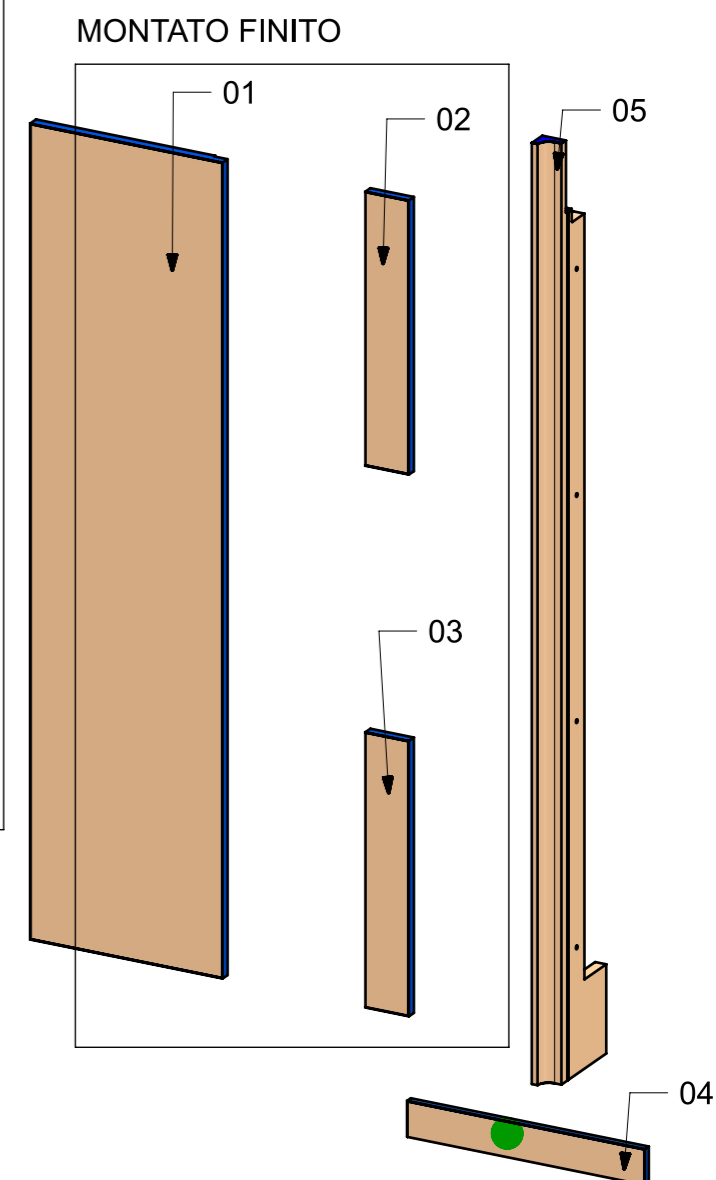
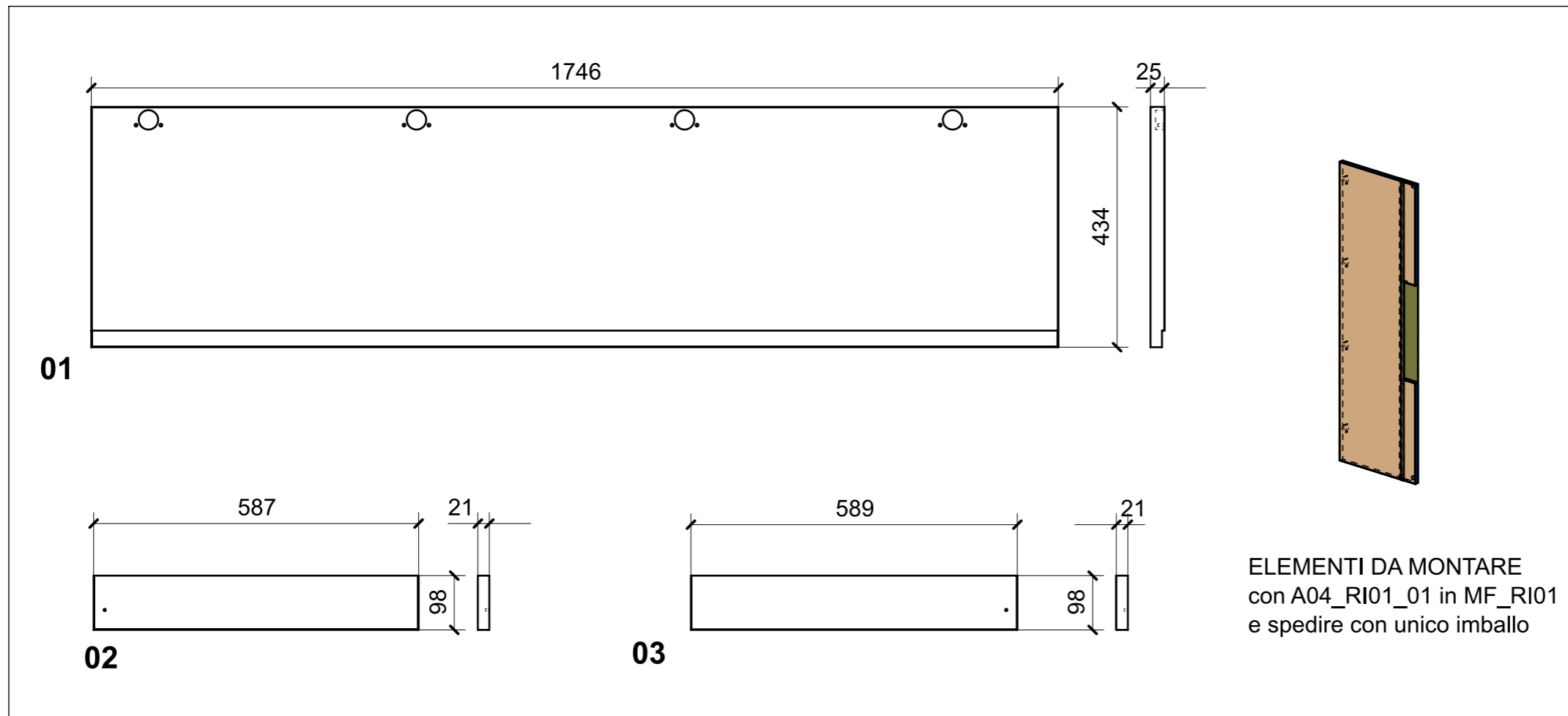

ELEMENTI DA MONTARE  
con A04\_RI01\_01 in MF\_RI01  
e spedire con unico imballo

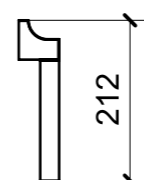
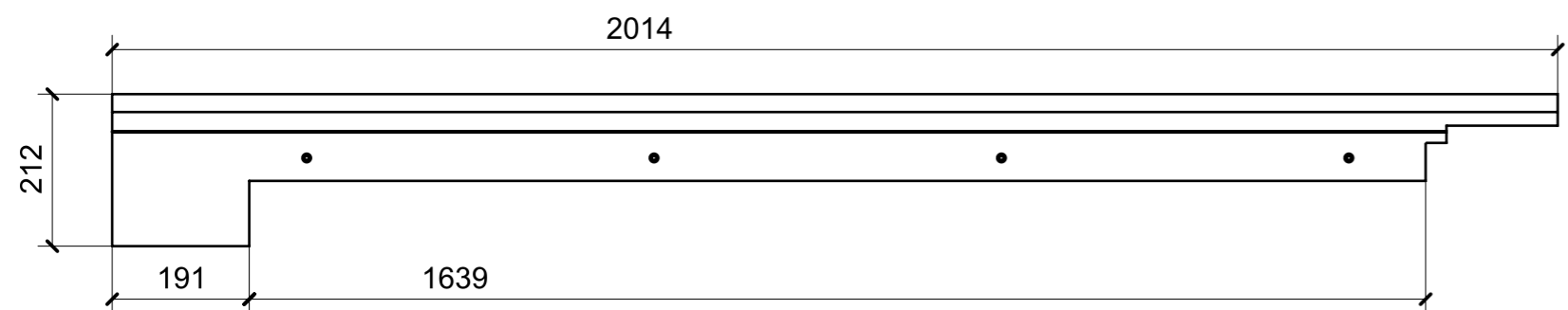
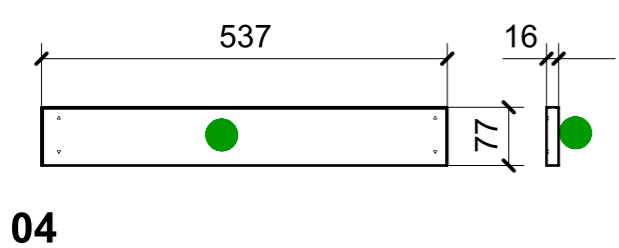

FERRAMENTA	QTY
BUSSOLA 6MA X 10 FORO DIAM.8	4
MAGNETE FORZA MAGNETICA1-5 10KG_HAFELE_246.87.112	2
BUSSOLA 5MA ANKOR BORGHI X CERNIERA PIANA	8
BUSSOLA AD ESPANSIONE_HAFELE_042.98.051	4

VERNICIATURA LASTRA/LACCATI:  
● = VERNICIARE 1 LATO + FILI RASATI O BORDATI      NESSUN SIMBOLO = VERNICIARE 2 LATI + FILI RASATI O BORDATI

05

LOCALE	CODICE	DESCRIZIONE COMPONENTE	FINITURA	GR.
CABINA OSPITI DX	MD320_R01_RM01	PLENUM ARMADIO	LASTRA SCURA	2

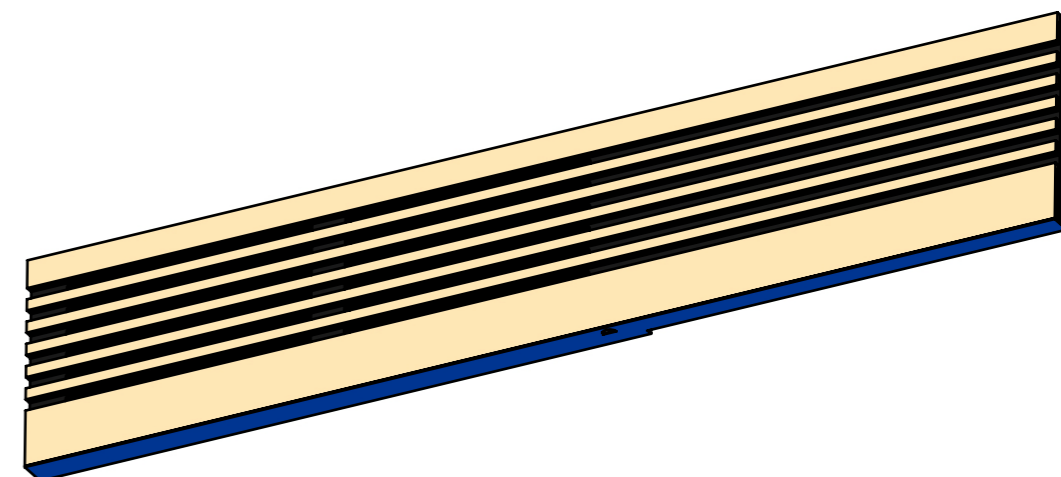
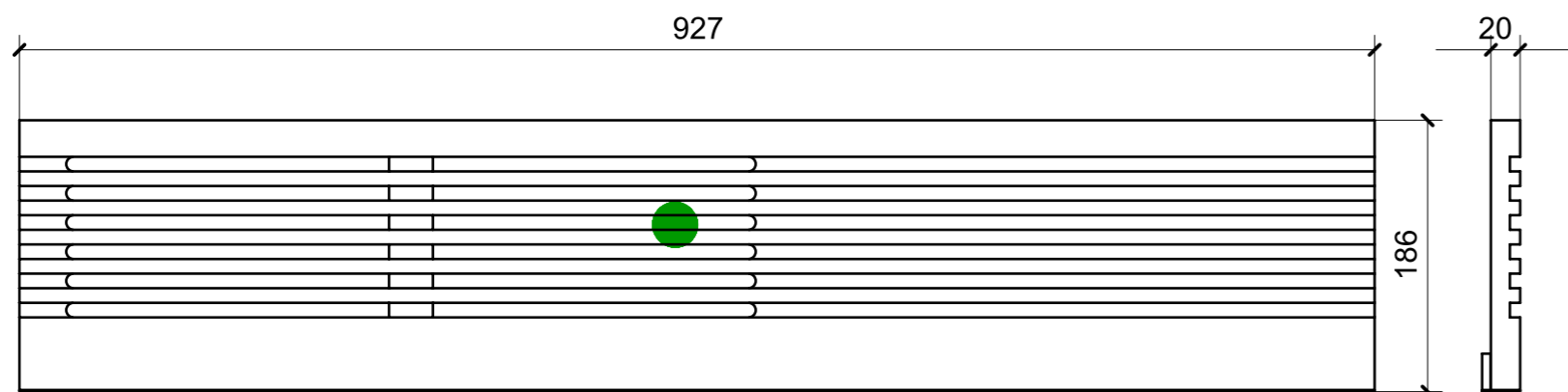

VERNICIATURA LASTRA/LACCATI:

● = VERNICIARE 1 LATO + FILI RASATI O BORDATI

NESSUN SIMBOLO = VERNICIARE 2 LATI + FILI RASATI O BORDATI