

LOCALE	CODICE	DESCRIZIONE COMPONENTE	FINITURA	GR.
CABINA OSPITI SX	MD320_R01_LA01	ARMADIO	LASTRA SCURA	2

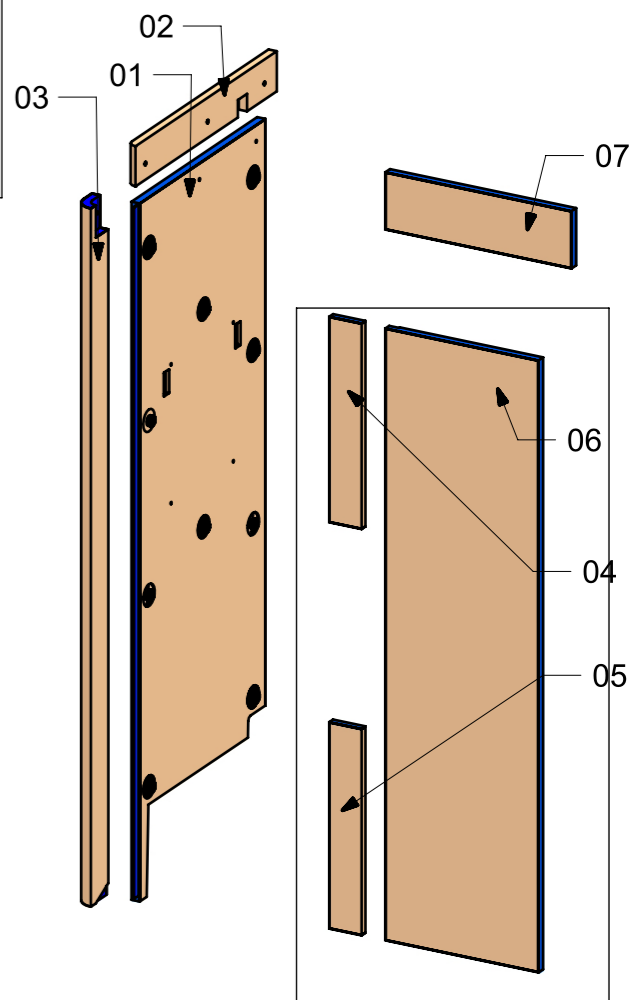
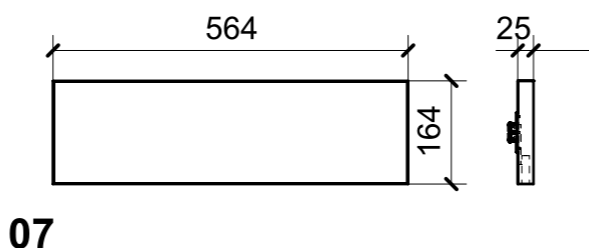
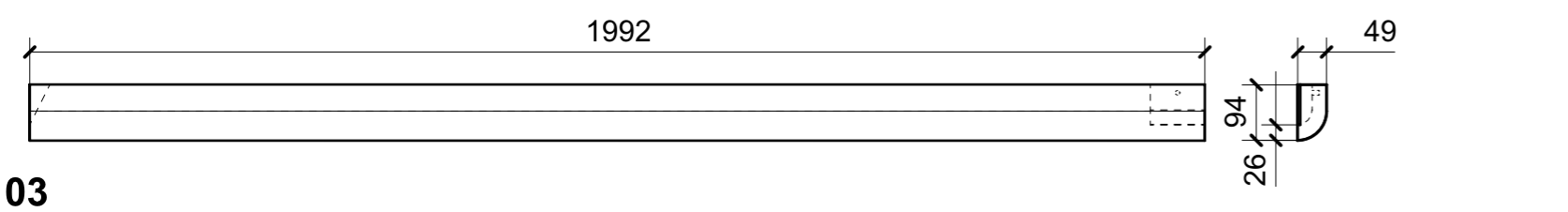
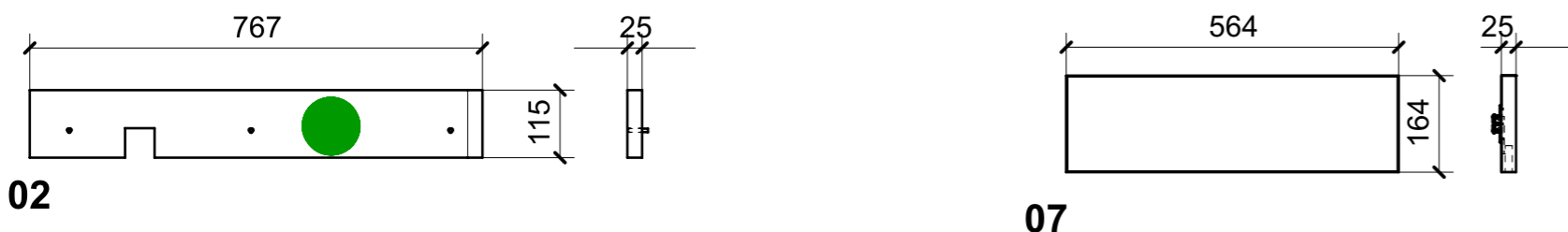
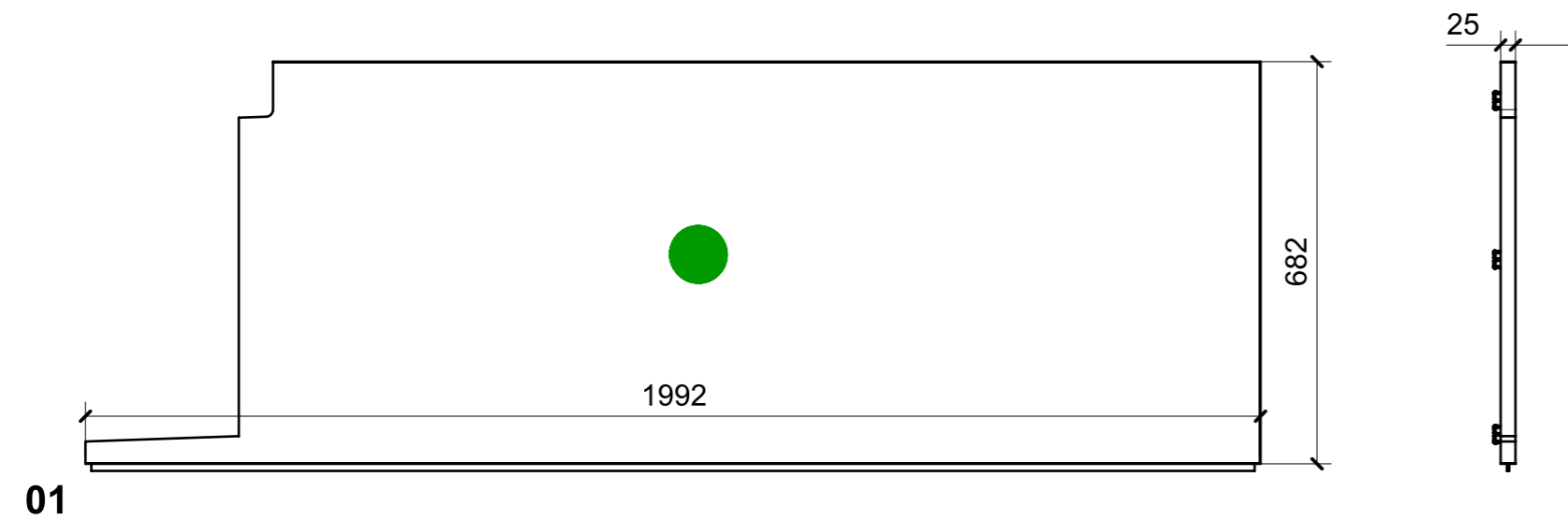
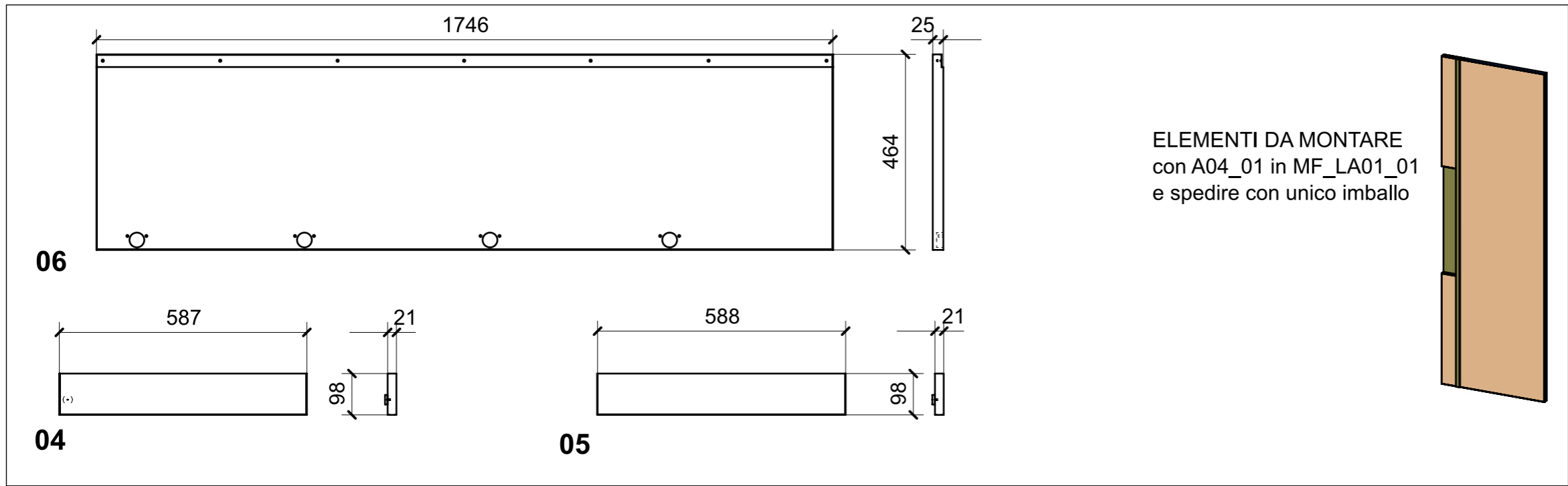

FERRAMENTA	QTY
FITLOCK M_MASCHERPA_3MM_6020202101	12
MAGNETE FORZA MAGNETICA1-5 10KG_HAFELE_246.87.112	2
VITE 6MA X 35 TESTA SVASATA	3
BUSSOLA AD ESPANSIONE_HAFELE_042.98.051	7

VERNICIATURA LASTRA/LACCATI:
● = VERNICIARE 1 LATO + FILI RASATI O BORDATI NESSUN SIMBOLO = VERNICIARE 2 LATI + FILI RASATI O BORDATI

LOCALE	CODICE	DESCRIZIONE COMPONENTE	FINITURA	GR.
CABINA OSPITI SX	MD320_R01_LC01	STRUTTURA MURATA	LASTRA SCURA	2

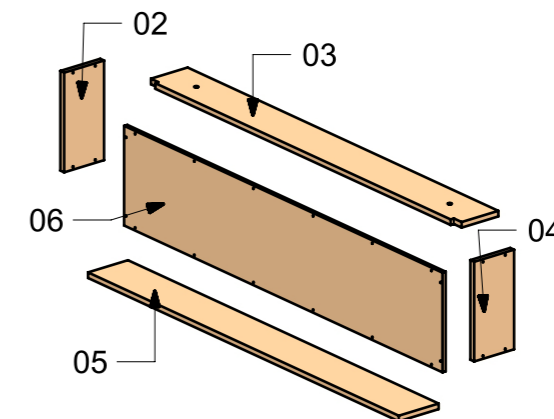
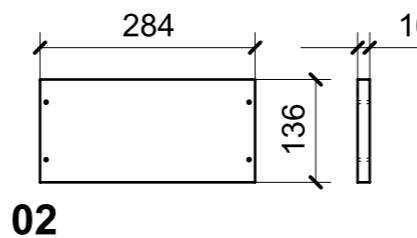
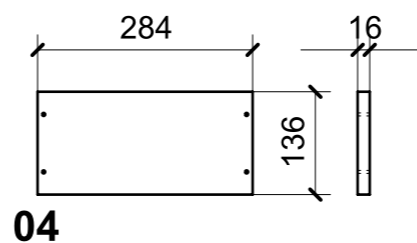
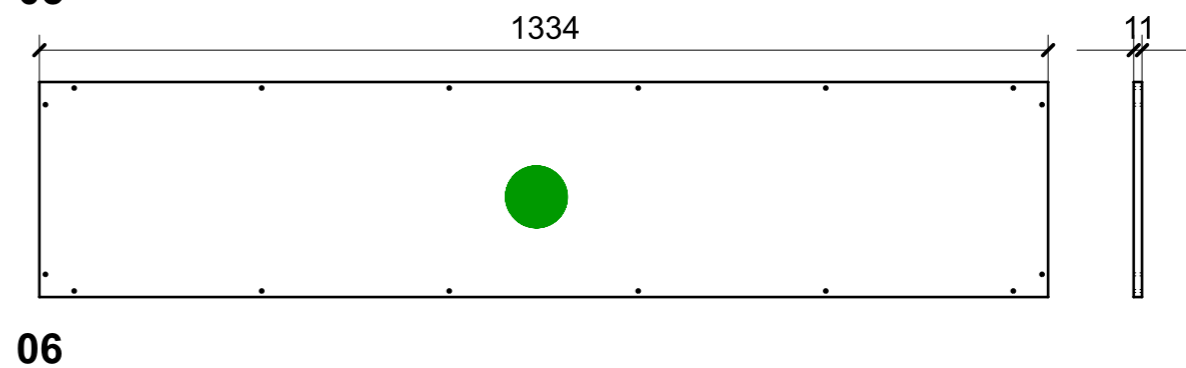
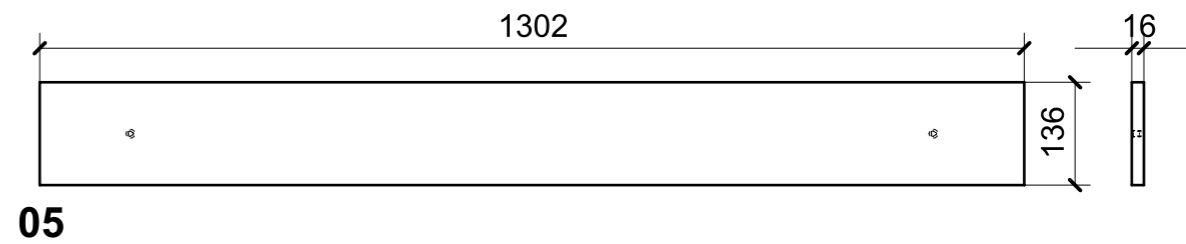
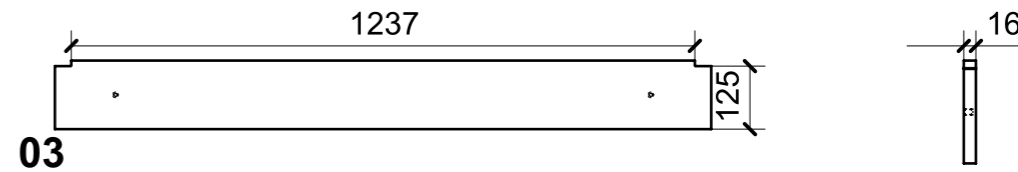
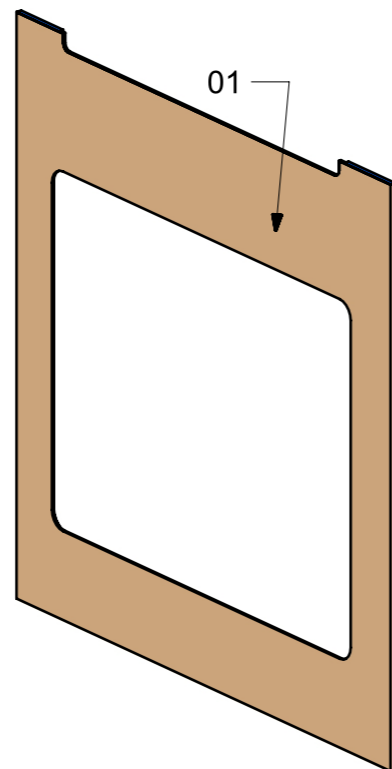
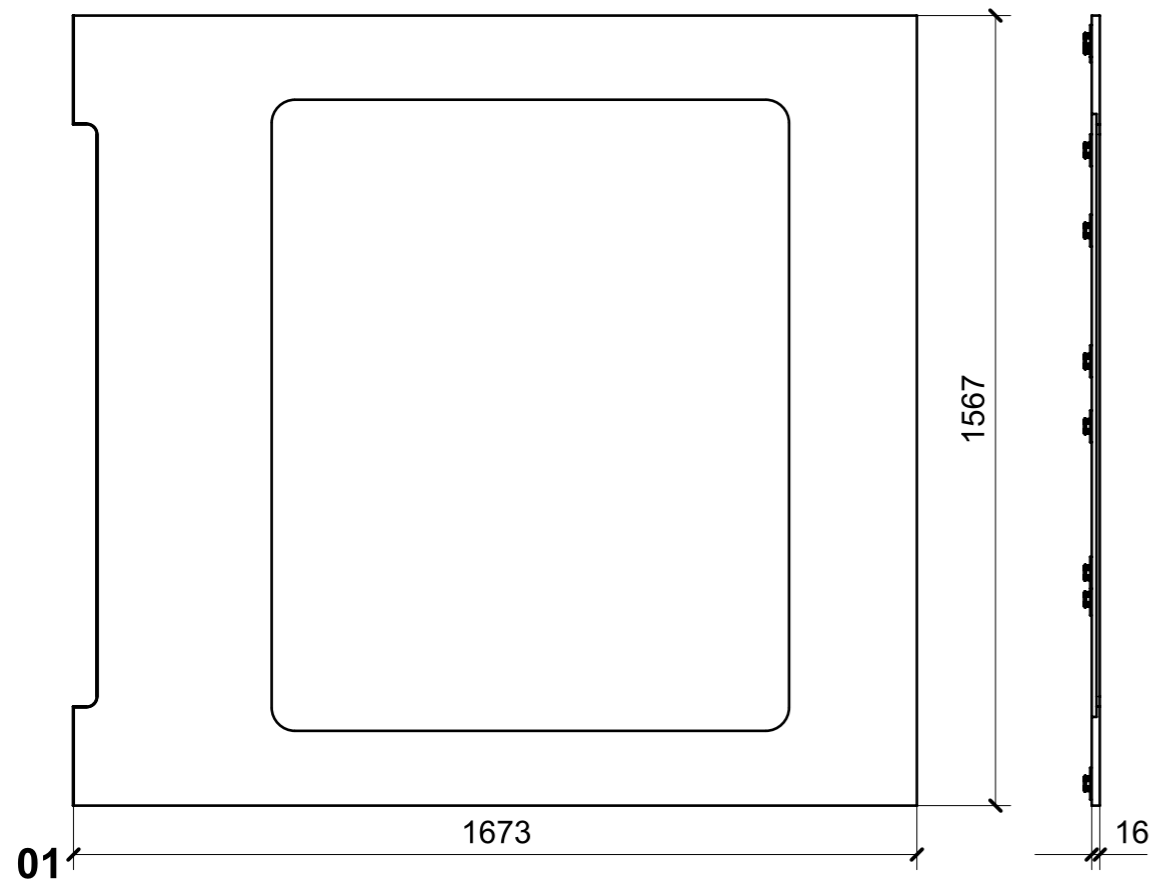

ELEMENTI DA MONTARE
in MG_LC01
spedire con unico imballo

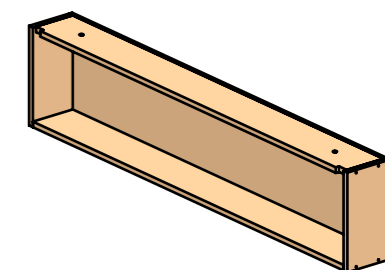

FERRAMENTA	QTY
BUSSOLA 6MA X 10 FORO DIAM.8	4
FITLOCK M_MASCHERPA_3MM_6020202101	17

VERNICIATURA LASTRA/LACCATI:

● = VERNICIARE 1 LATO + FILI RASATI O BORDATI

NESSUN SIMBOLO = VERNICIARE 2 LATI + FILI RASATI O BORDATI

LOCALE	CODICE	DESCRIZIONE COMPONENTE	FINITURA	GR.
CABINA OSPITI SX	MD320_R02_LC01	STRUTTURA MURATA	LASTRA CHIARA	2

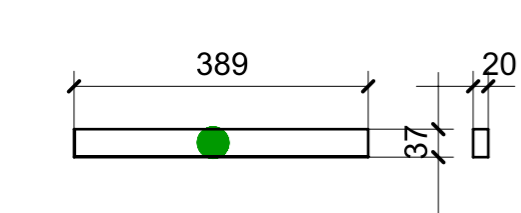

03

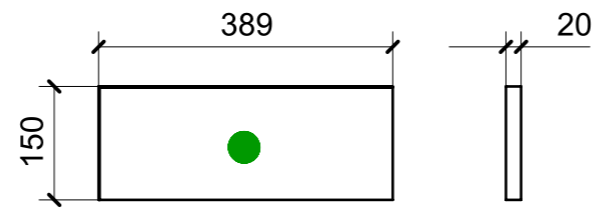

04

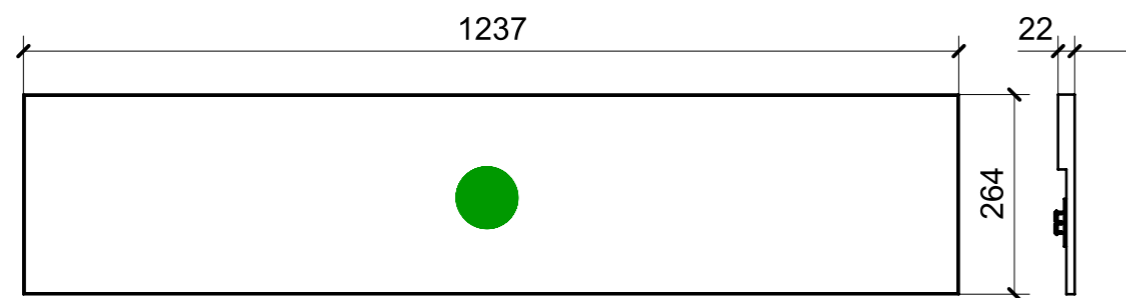

02

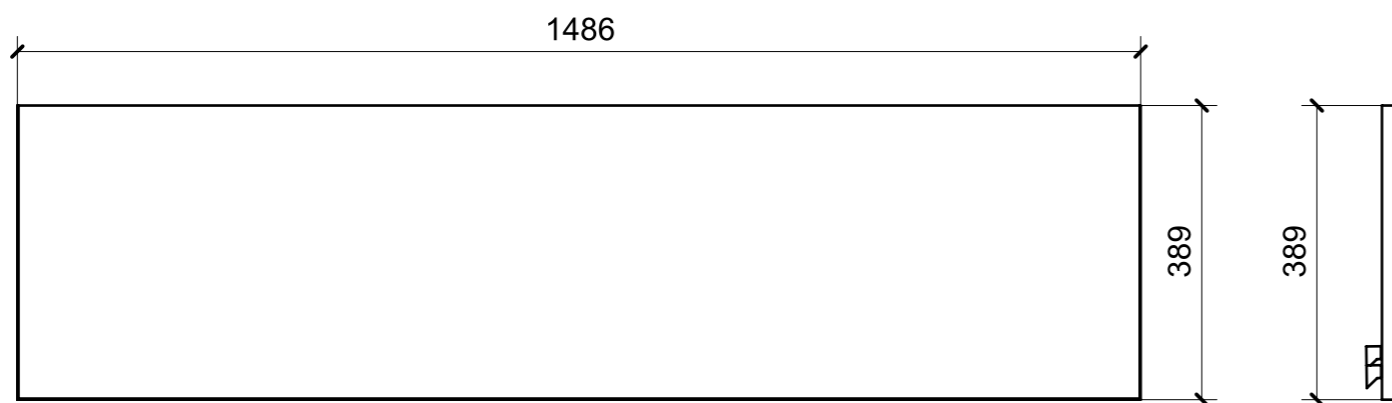

01

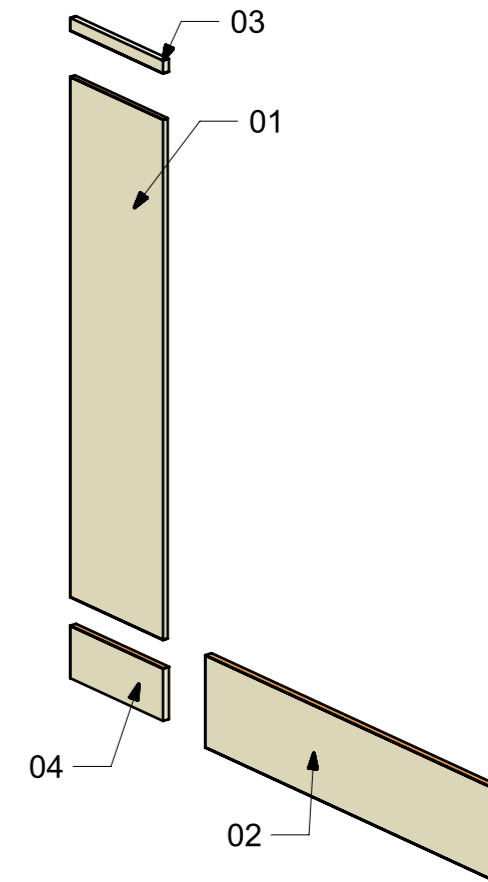

FERRAMENTA	QTY
FITLOCK M_MASCHERPA_3MM_6020202101	4

VERNICIATURA LASTRA/LACCATI:

● = VERNICIARE 1 LATO + FILI RASATI O BORDATI

NESSUN SIMBOLO = VERNICIARE 2 LATI + FILI RASATI O BORDATI

LOCALE	CODICE	DESCRIZIONE COMPONENTE	FINITURA	GR.
CABINA OSPITI SX	MD320_R02_LE01	STRUTTURA TESTATA LETTO	LASTRA CHIARA	2

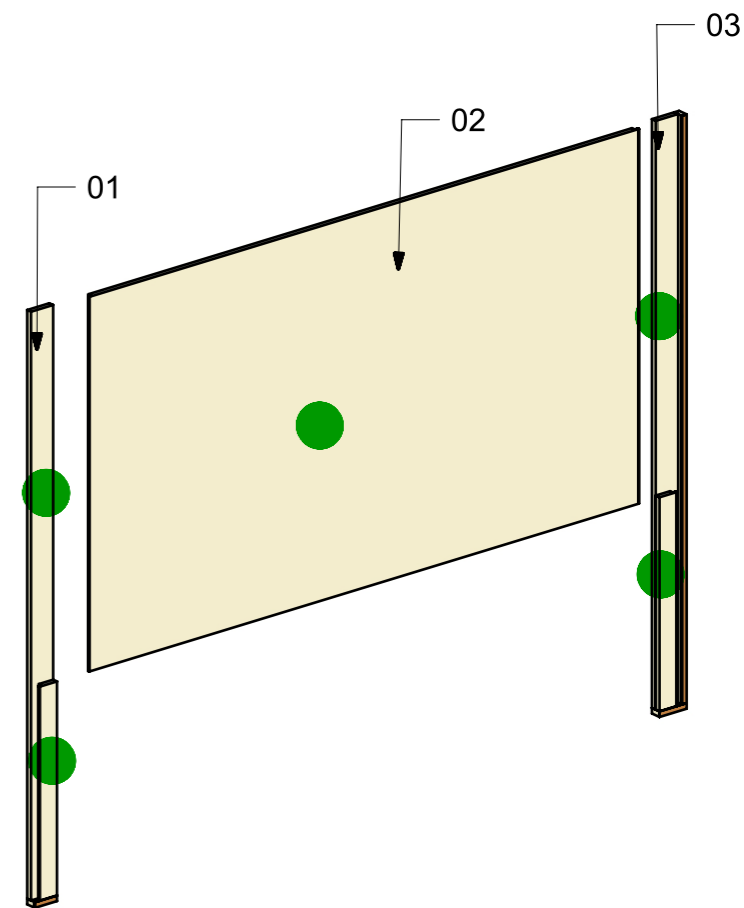
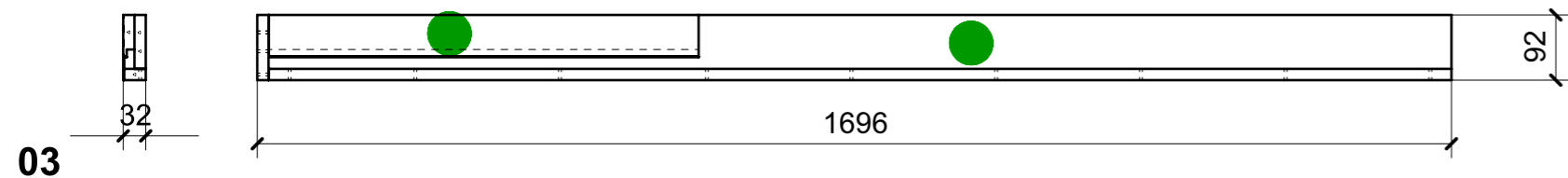
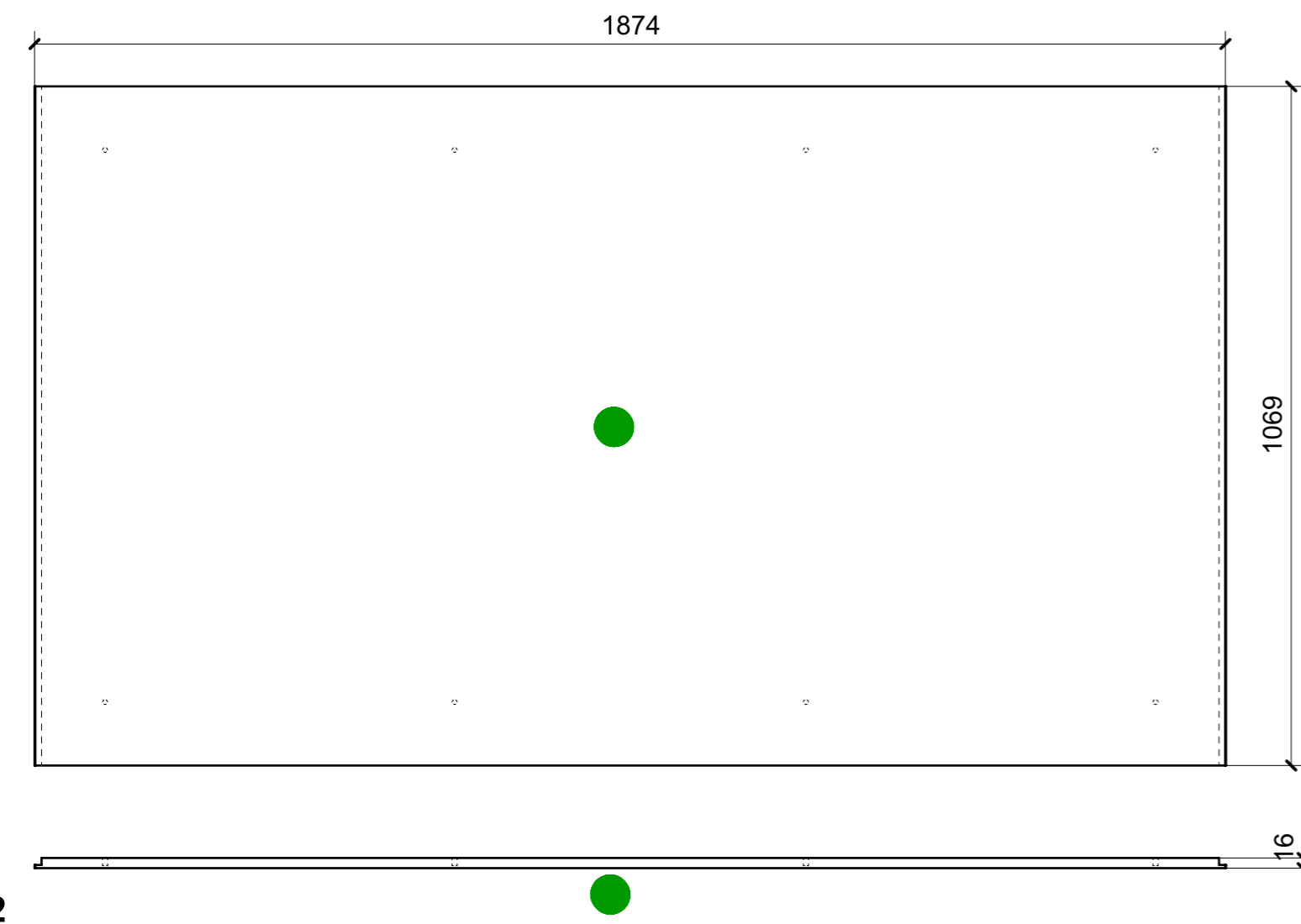
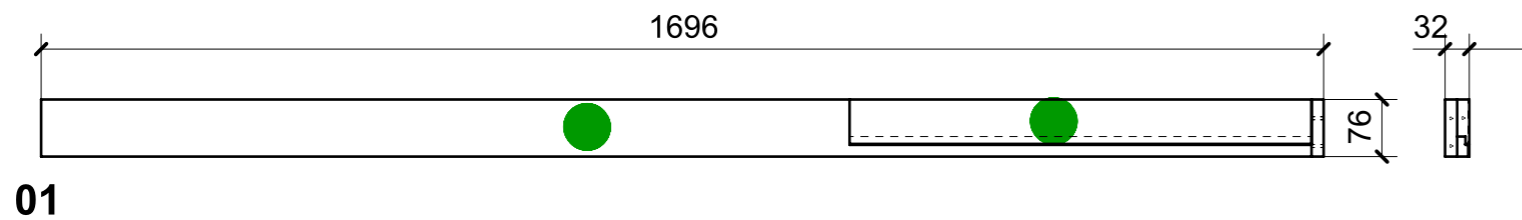

VERNICIATURA LASTRA/LACCATI:

● = VERNICIARE 1 LATO + FILI RASATI O BORDATI

NESSUN SIMBOLO = VERNICIARE 2 LATI + FILI RASATI O BORDATI

LOCALE	CODICE	DESCRIZIONE COMPONENTE	FINITURA	GR.
CABINA OSPITI SX	MD320_R02_LF01	RIV. PARETI CENTRO NAVE	LASTRA CHIARA	2

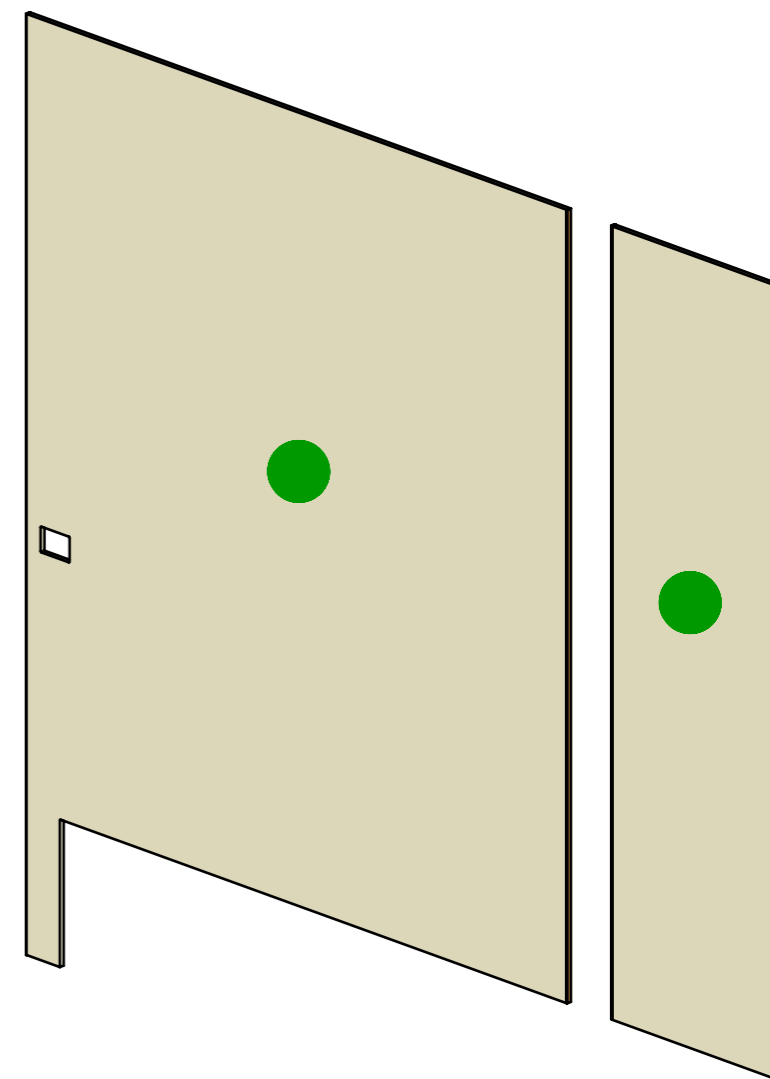
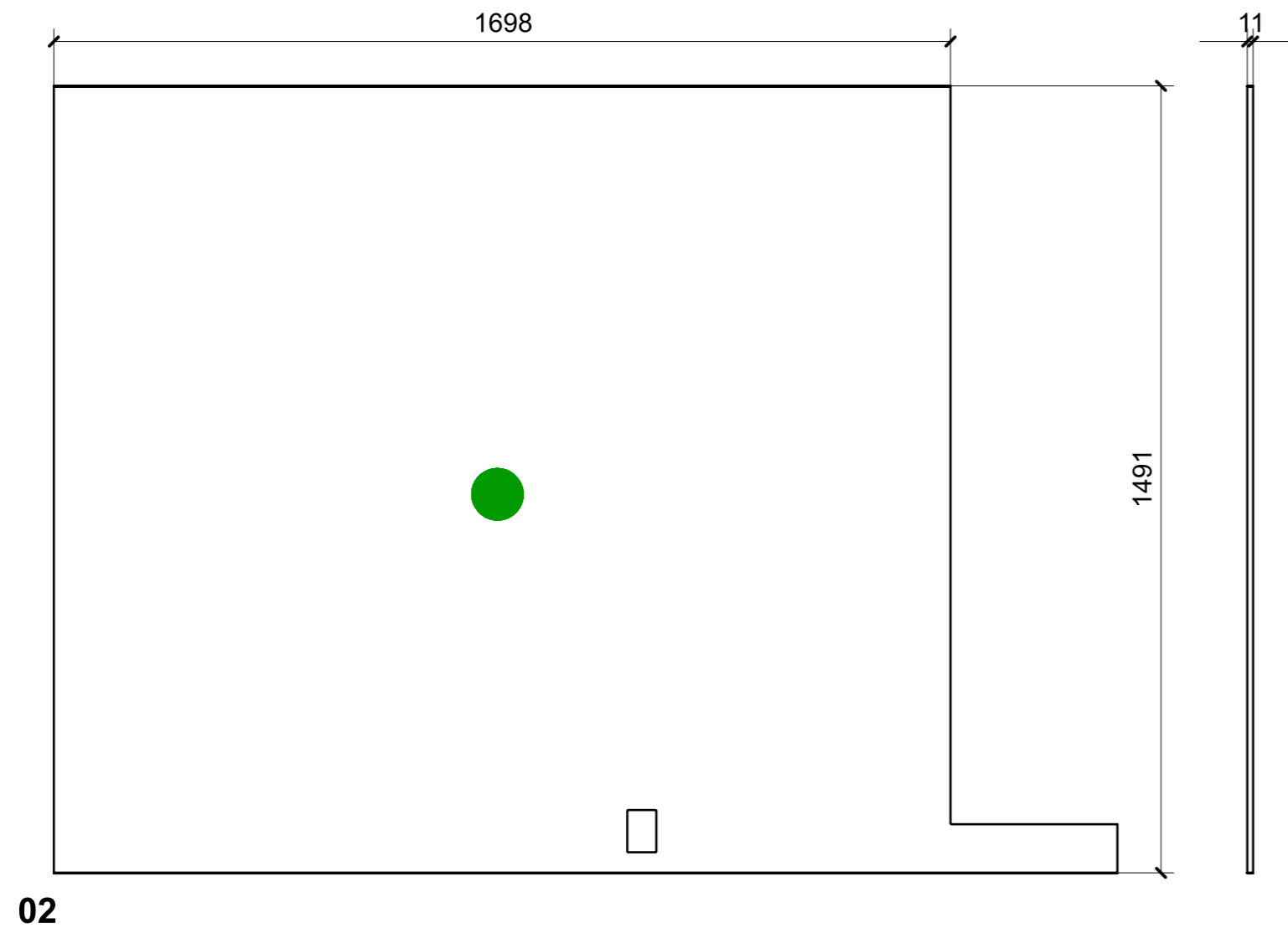
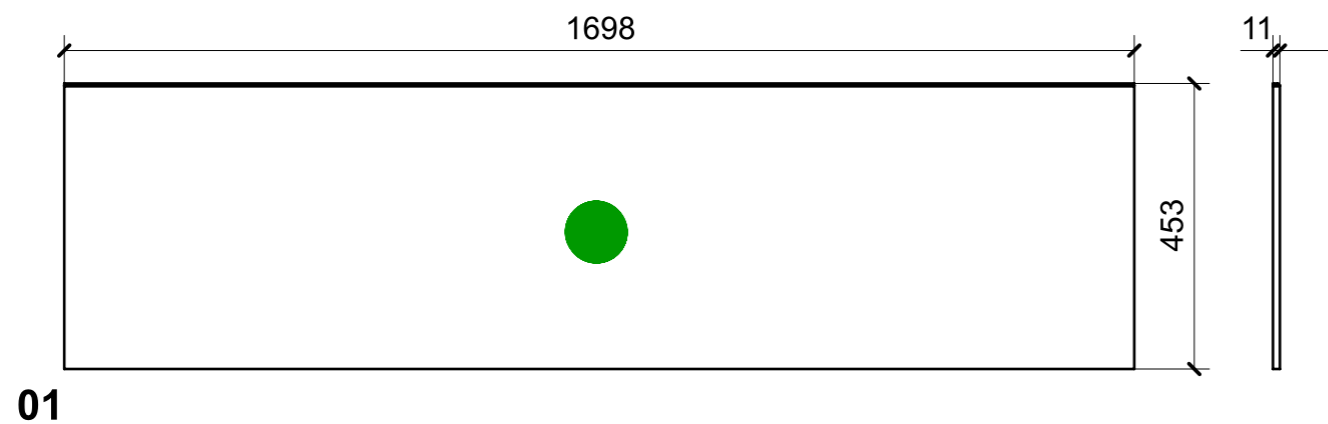

VERNICIATURA LASTRA/LACCATI:

● = VERNICIARE 1 LATO + FILI RASATI O BORDATI

NESSUN SIMBOLO = VERNICIARE 2 LATI + FILI RASATI O BORDATI

LOCALE	CODICE	DESCRIZIONE COMPONENTE	FINITURA	GR.
CABINA OSPITI SX	MD320_R01_LL01	RIV. PARETI PRUA	LASTRA SCURA	2

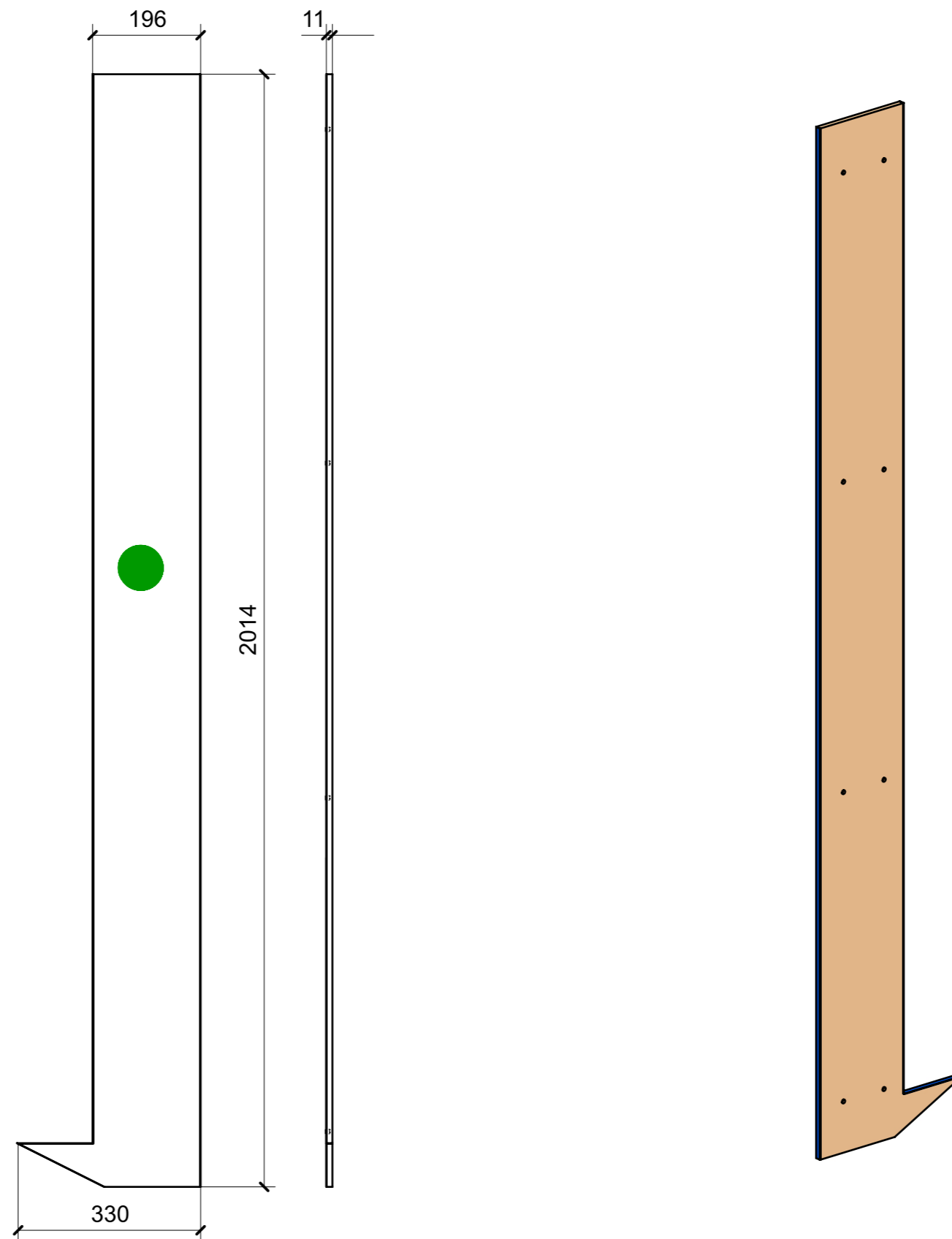

VERNICIATURA LASTRA/LACCATI:

● = VERNICIARE 1 LATO + FILI RASATI O BORDATI

NESSUN SIMBOLO = VERNICIARE 2 LATI + FILI RASATI O BORDATI

LOCALE	CODICE	DESCRIZIONE COMPONENTE	FINITURA	GR.
CABINA OSPITI SX	MD320_R02_LL01	RIV. PARETI PRUA	LASTRA CHIARA	2

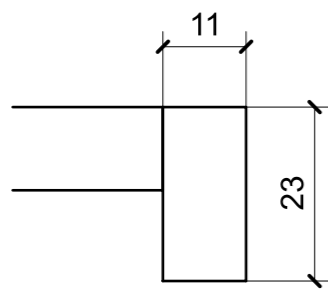

DETAIL B
SCALE 1:1

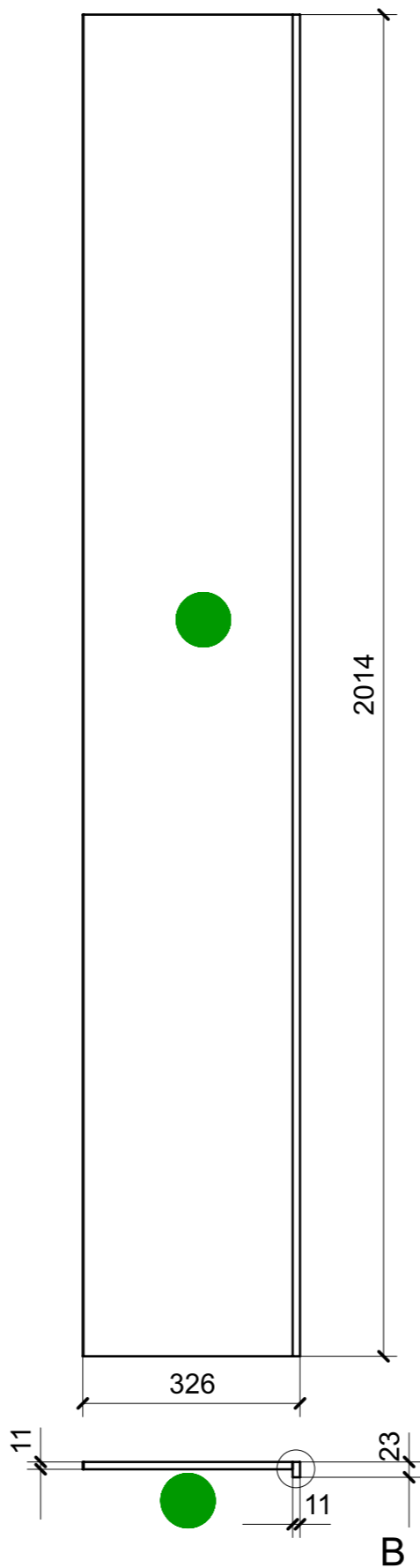

VERNICIATURA LASTRA/LACCATI:

● = VERNICIARE 1 LATO + FILI RASATI O BORDATI

NESSUN SIMBOLO = VERNICIARE 2 LATI + FILI RASATI O BORDATI

LOCALE	CODICE	DESCRIZIONE COMPONENTE	FINITURA	GR.
CABINA OSPITI SX	MD320_R02_LP01	LETTO PULLMAN OPT	LASTRA CHIARA	PTP

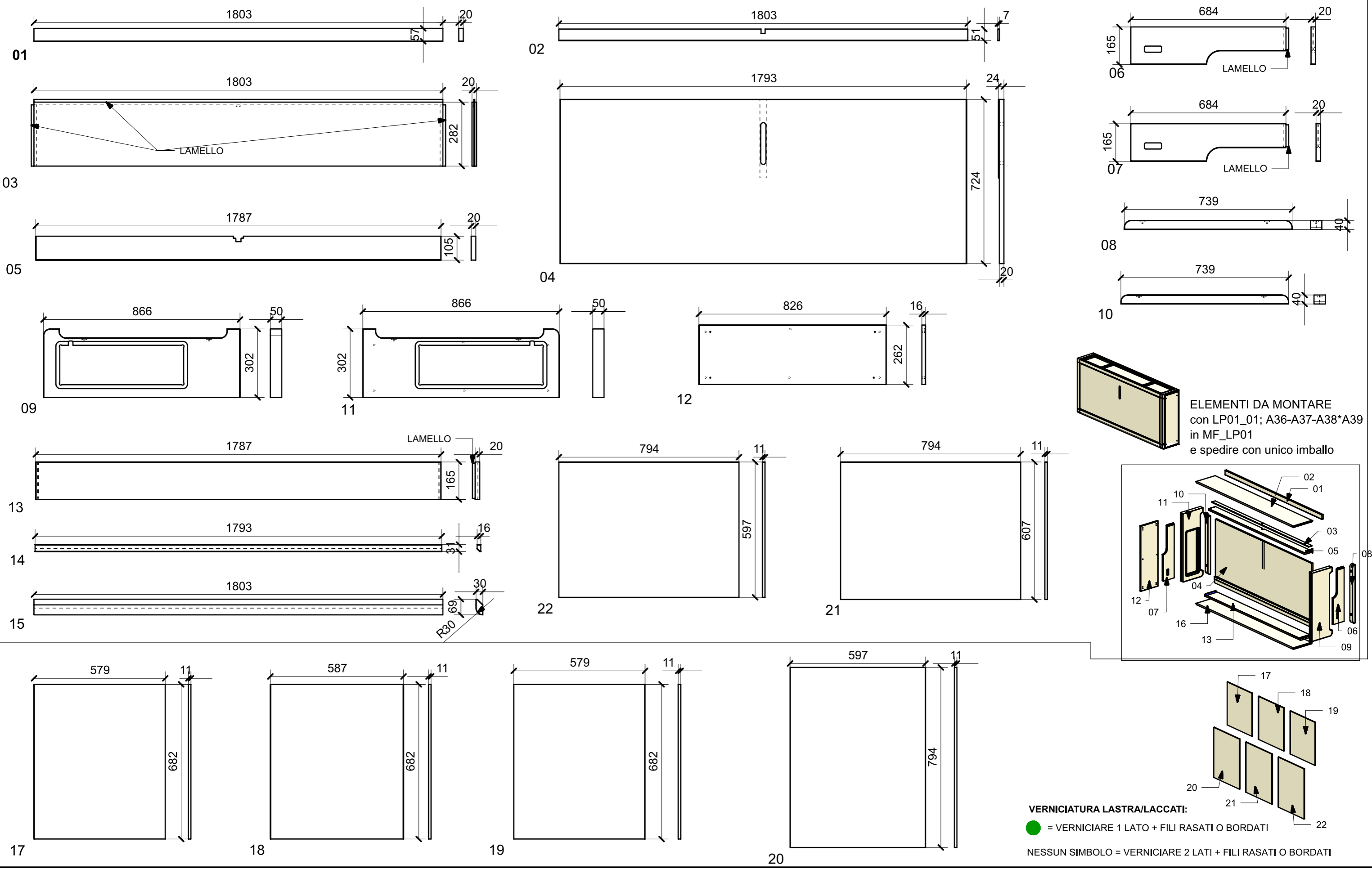

ELEMENTI DA MONTARE
 con LP01_01; A36-A37-A38*A39
 in MF_LP01
 e spedire con unico imballo

VERNICIATURA LASTRA/LACCATI:
 ● = VERNICIARE 1 LATO + FILI RASATI O BORDATI
 NESSUN SIMBOLO = VERNICIARE 2 LATI + FILI RASATI O BORDATI