

LOCALE	CODICE	DESCRIZIONE COMPONENTE	FINITURA	GR
PARATIE	MD298_MF_PR01	PARATIA BLOCCO BAGNO		5

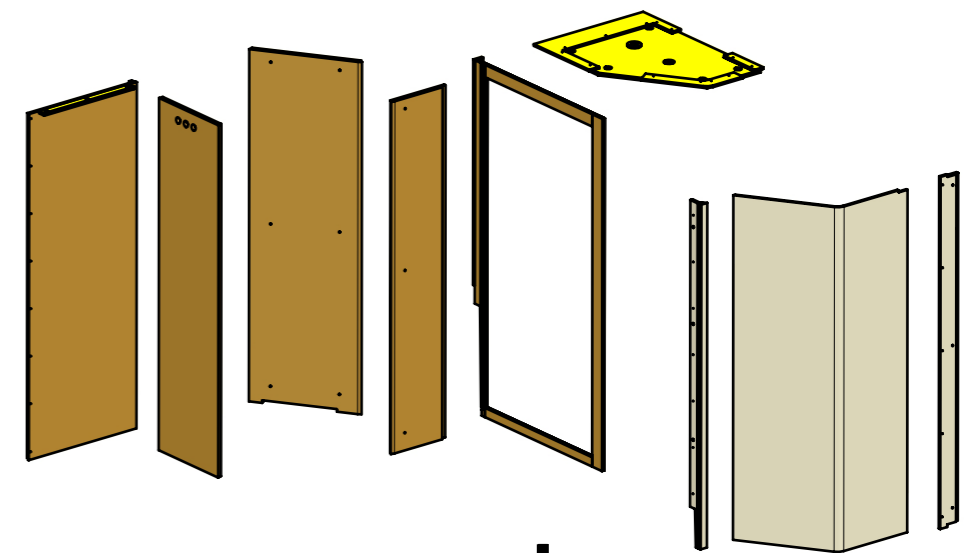

ELEMENTI DA MONTARE  
in MF\_PR01  
e spedire con unico imballo

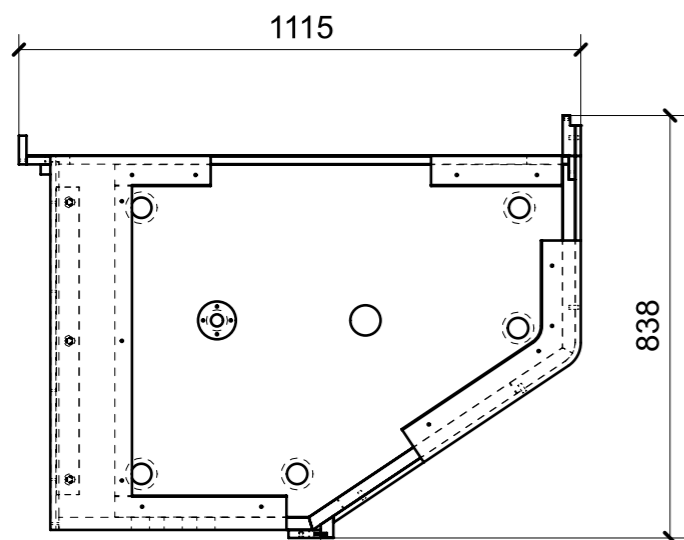
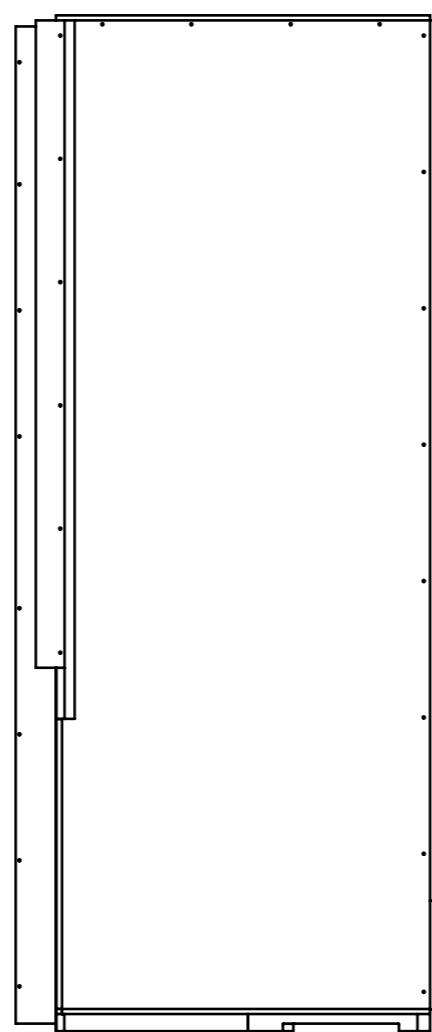
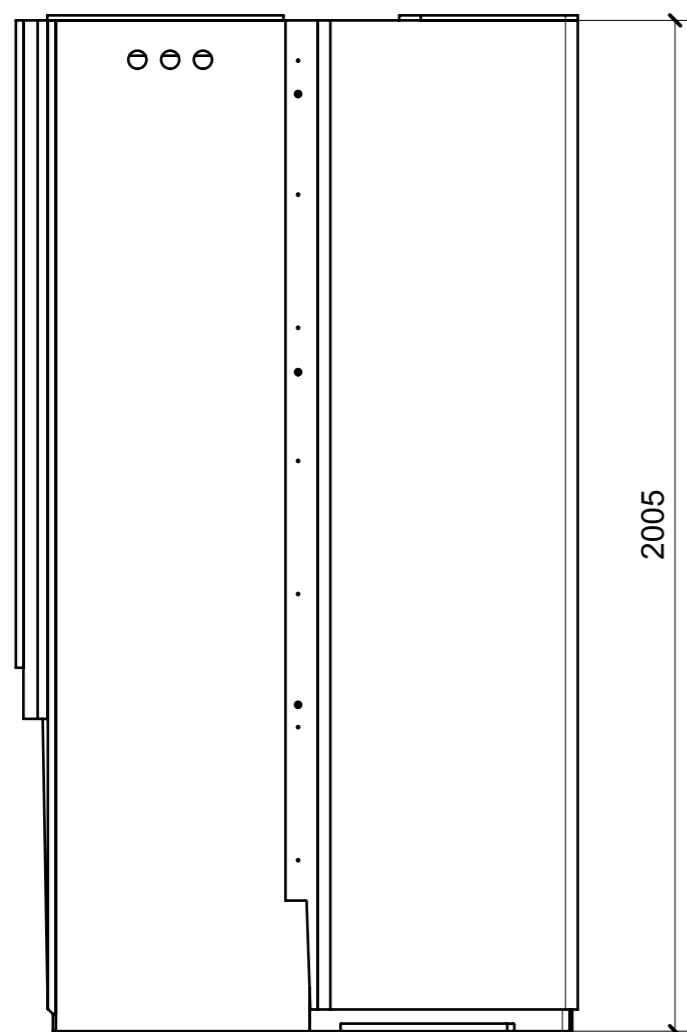
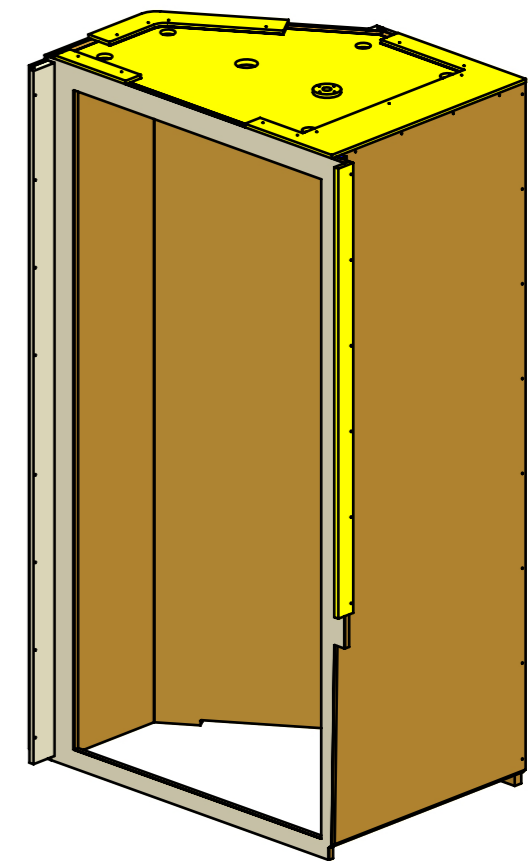
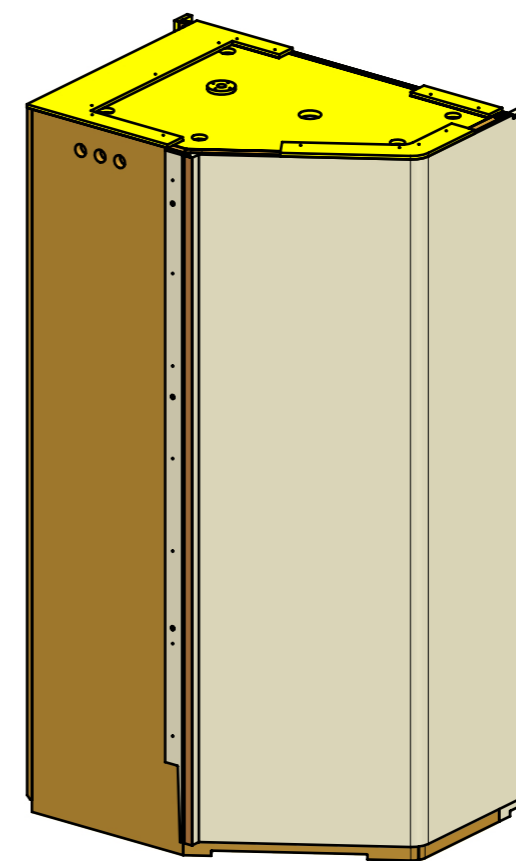

FERRAMENTA	QTY
FM INCASSO_ITALVIPLA_973_FMPC_F1A	3
BUSSOLA 6MA X 10 FORO DIAM.8	3

LOCALE	CODICE	DESCRIZIONE COMPONENTE	FINITURA	GR
PARATIE	MD298_PR01	PARATIA BLOCCO BAGNO	LAMINATO LG23 PORO ROVERE\LASTRA CHIARA\ GREZZO	5

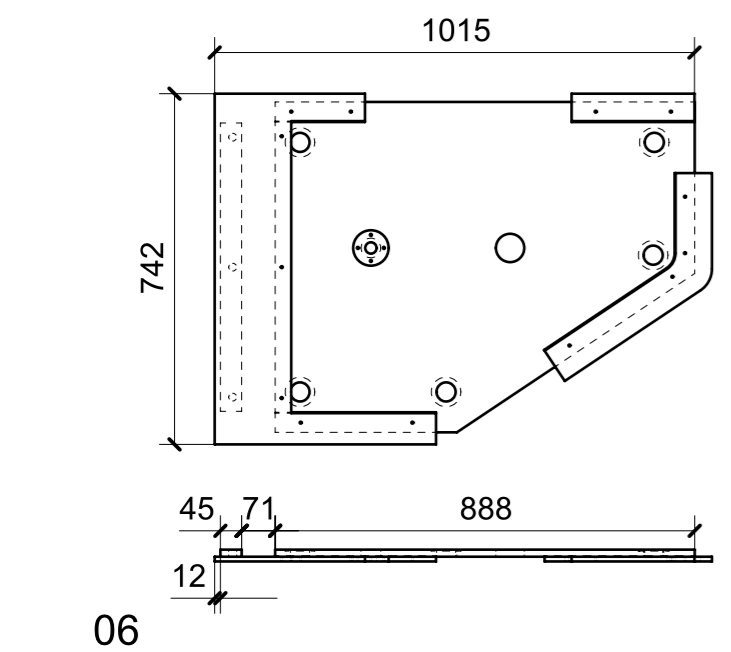
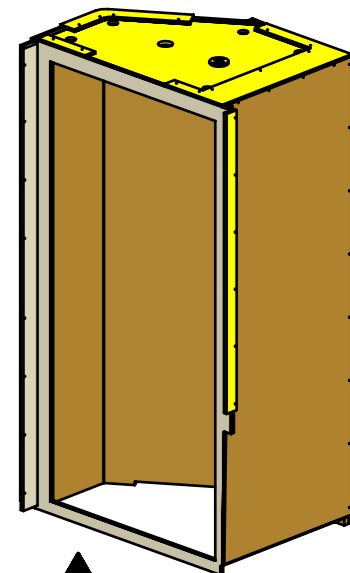
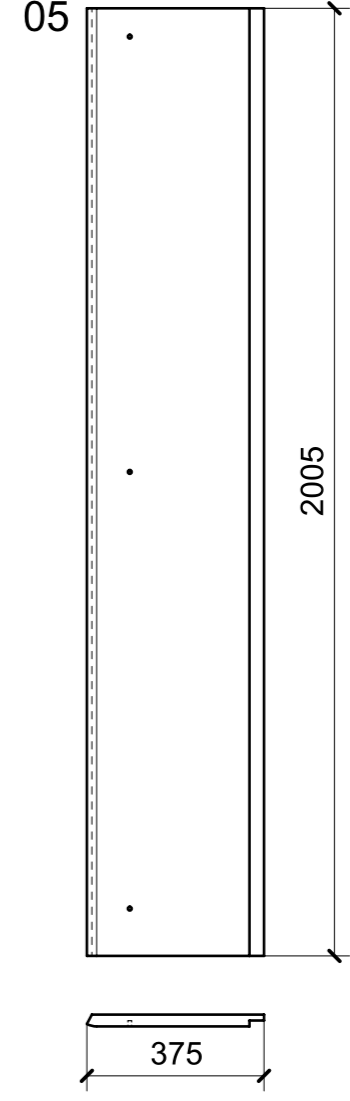
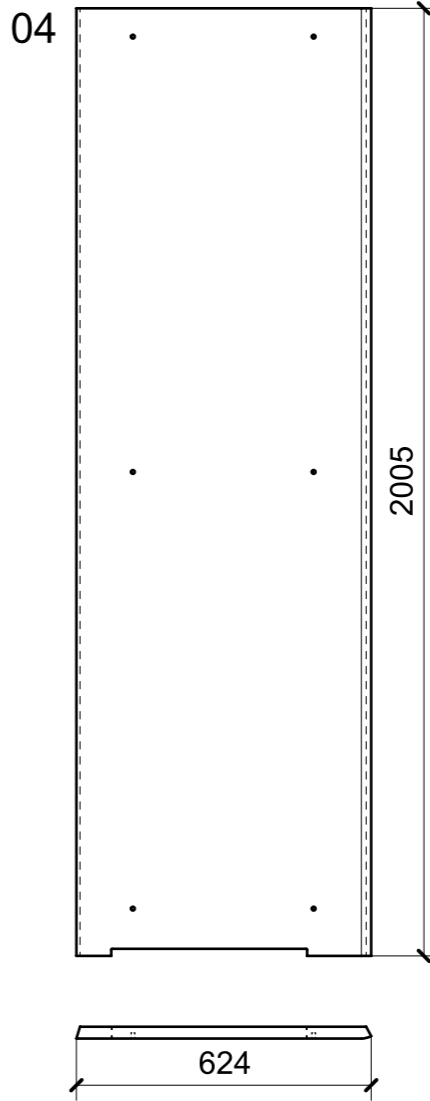
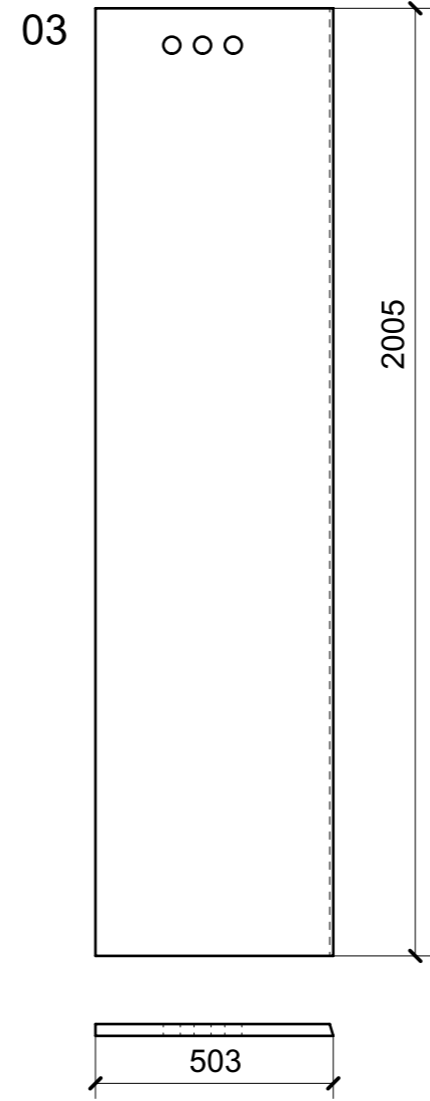
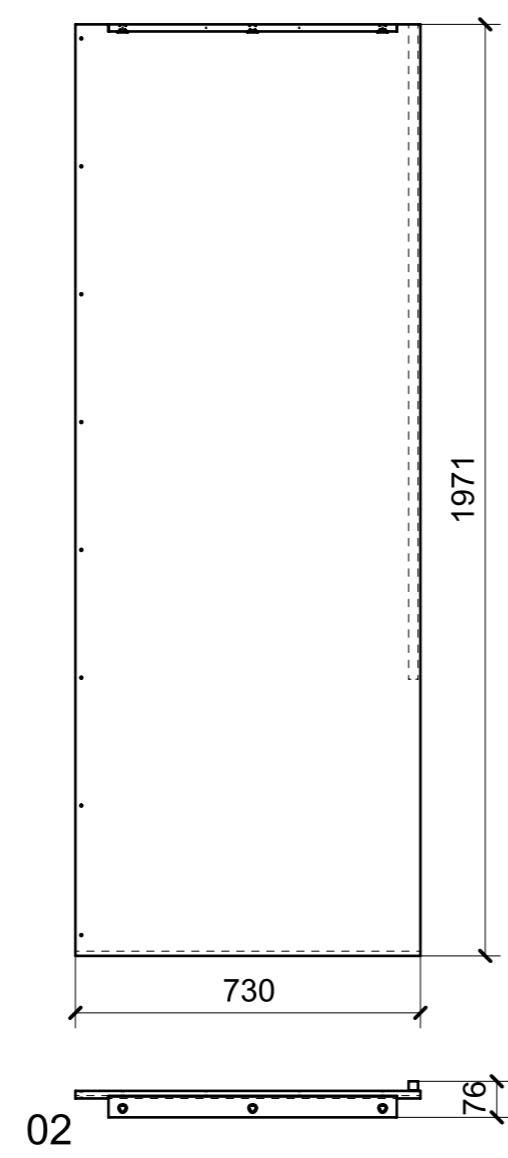
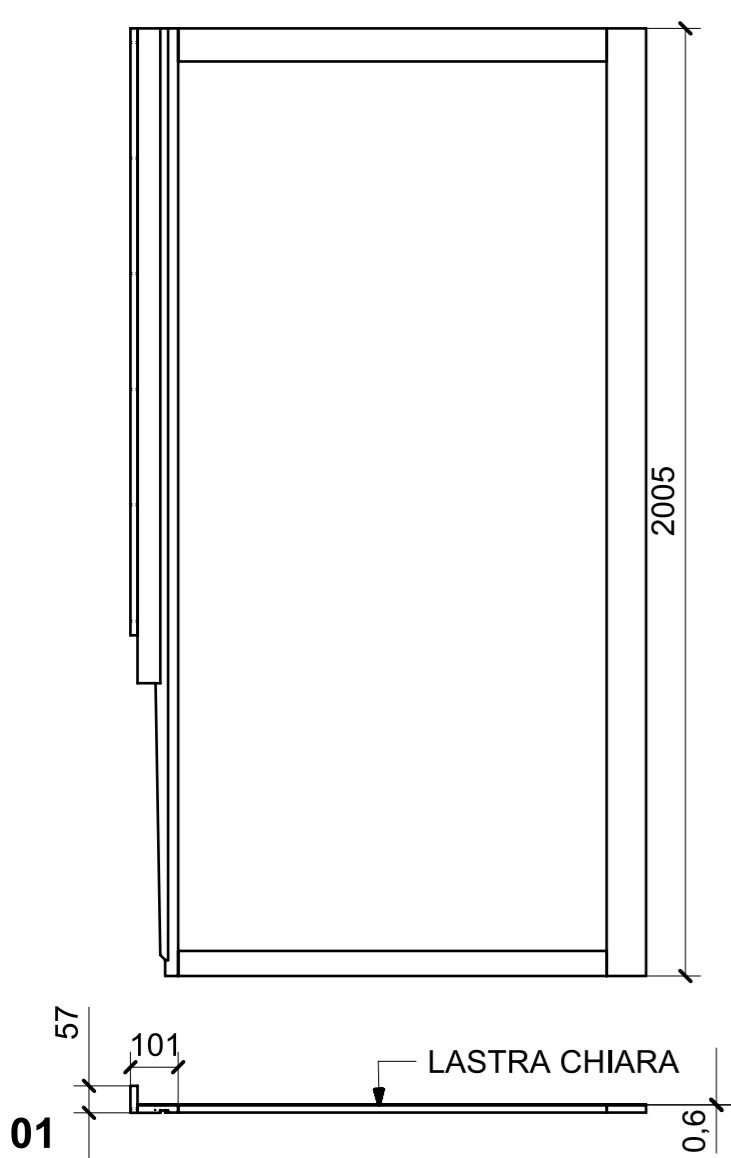

ELEMENTI DA MONTARE con R01\_PR01\_01/03 in MF\_PR01 e spedire con unico imballo

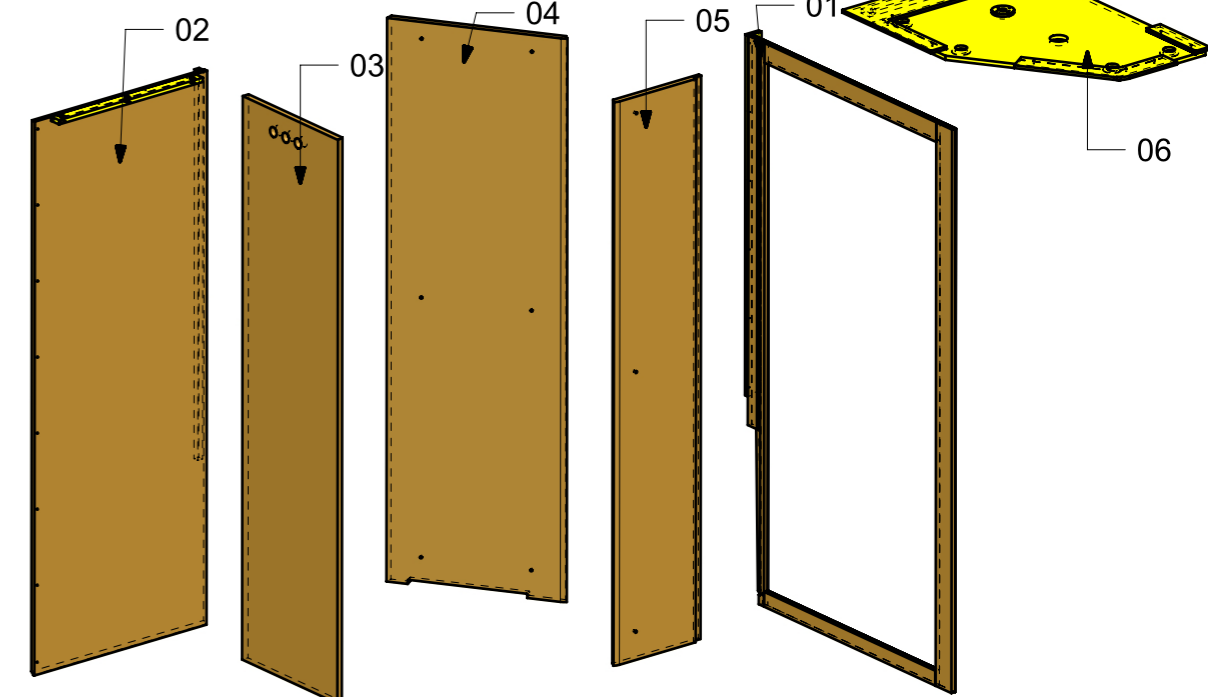

FERRAMENTA	QTY
FM INCASSO_ITALVIPLA_973_FMPC_F1A	3

LOCALE	CODICE	DESCRIZIONE COMPONENTE	FINITURA	GR
PARATIE	MD298_R01_PR01	PARATIA BLOCCO BAGNO	LASTRA CHIARA	5

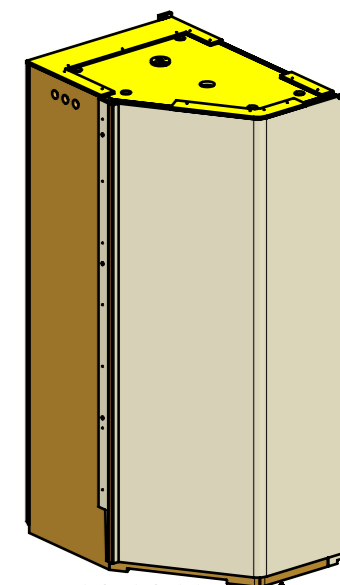
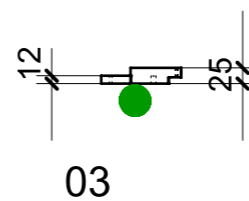
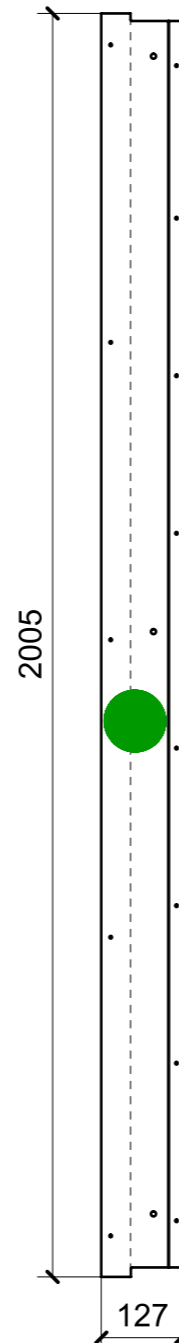
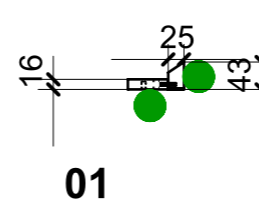
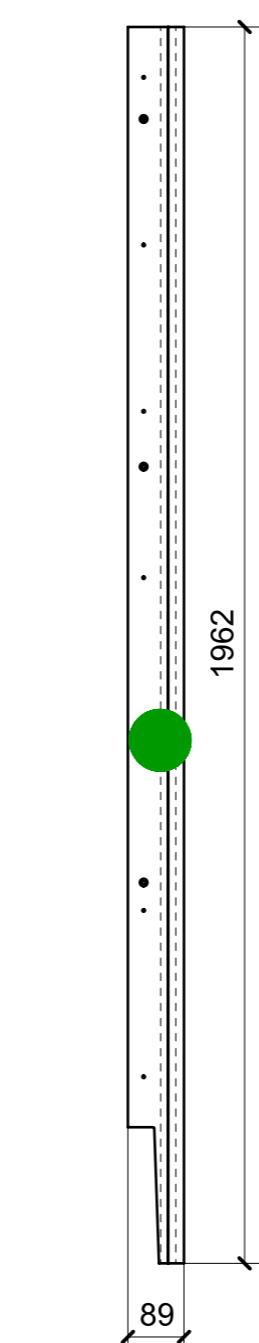
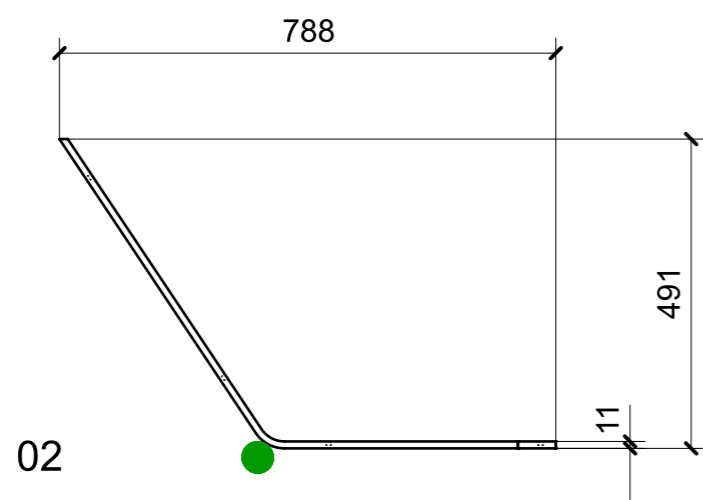
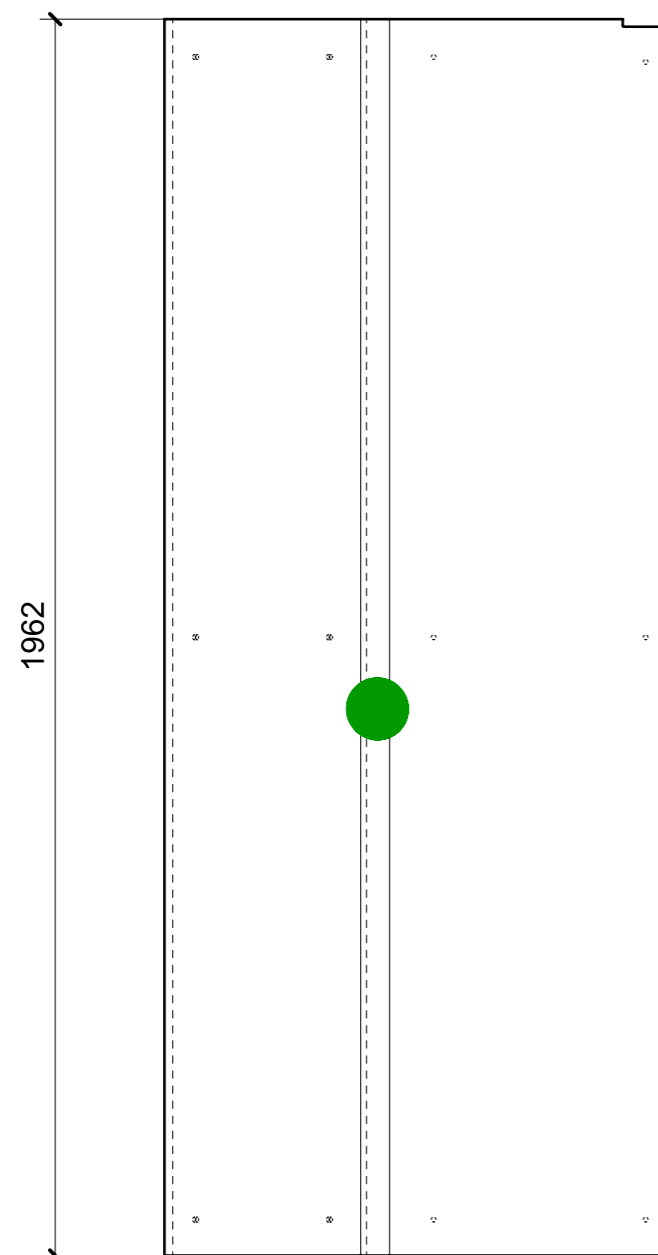

ELEMENTI DA MONTARE con PR01\_01/06  
in MF\_PR01  
e spedire con unico imballo

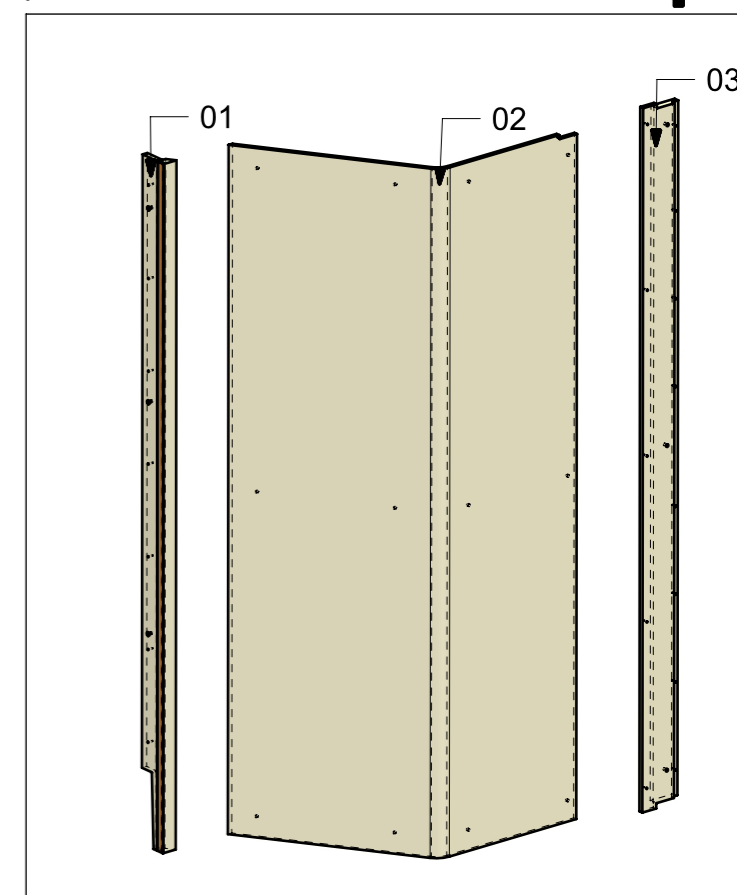

FERRAMENTA	QTY
BUSSOLA 6MA X 10 FORO DIAM.8	3

VERNICIATURA LASTRA/LACCATI:

● = VERNICIARE 1 LATO + FILI RASATI O BORDATI

NESSUN SIMBOLO = VERNICIARE 2 LATI + FILI RASATI O BORDATI