

LOCALE	CODICE	DESCRIZIONE COMPONENTE	FINITURA	GR
CUCINA	MD298_MG_KF01	PORTA OGGETTI CUCINA	LACCATO SERIE 90 MFY-01.02	8

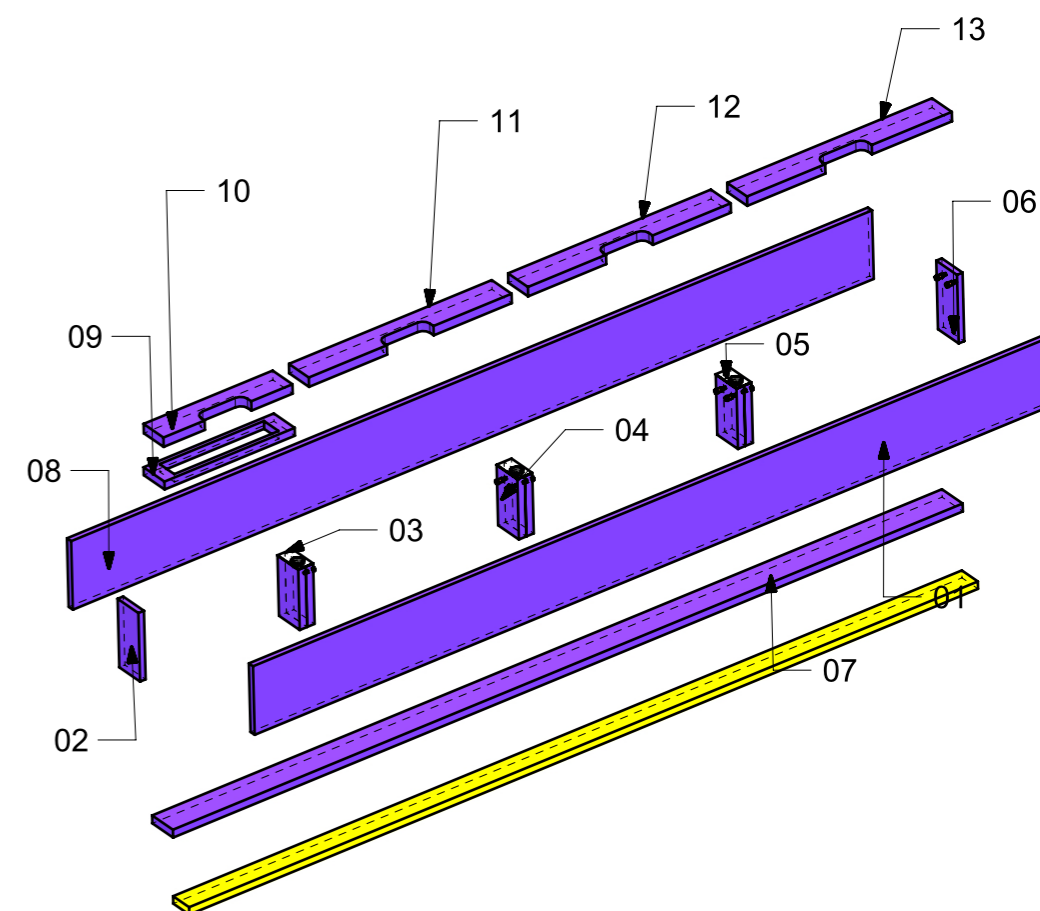

FERRAMENTA	QTY
MAGNETE FORZA MAGNETICA1-5 10KG_HAFELE_246.87.112	3
BUSSOLA RAPIDA_FBC BORGHI_00280877	12
REGGIRIPIANO PERNO RAPIDO X CR. CO-RING_FBC BORGHI_00073653	12

LOCALE	CODICE	DESCRIZIONE COMPONENTE	FINITURA	GR
CUCINA	MD298_L01_KF01	PORTA OGGETTI CUCINA	LACCATO SERIE 90 MFY-01.02	8

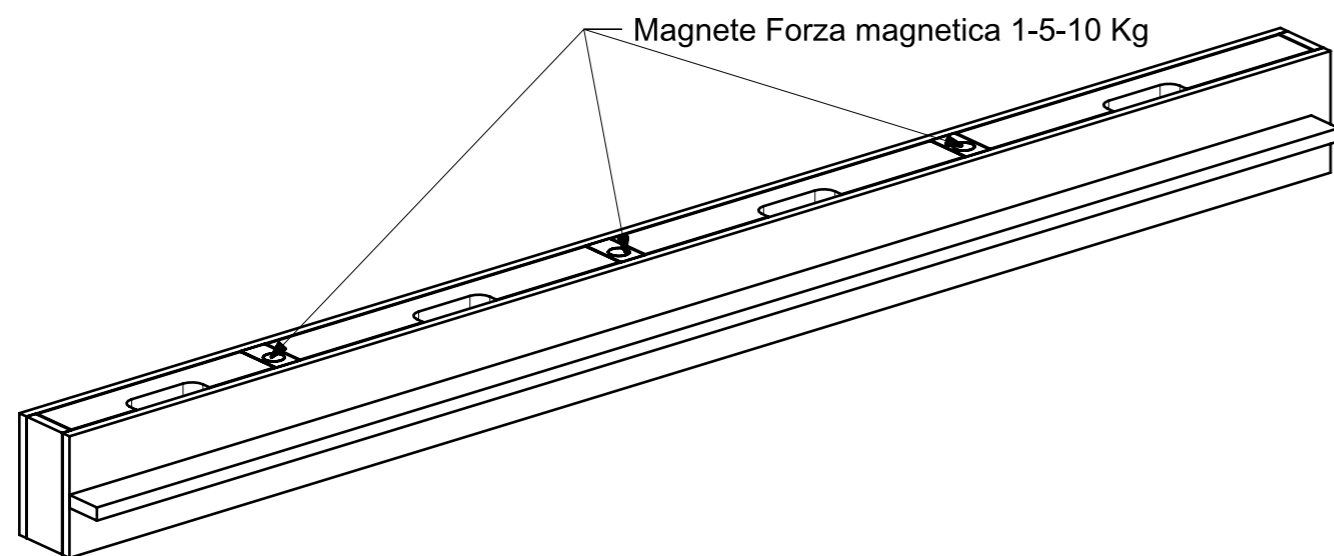
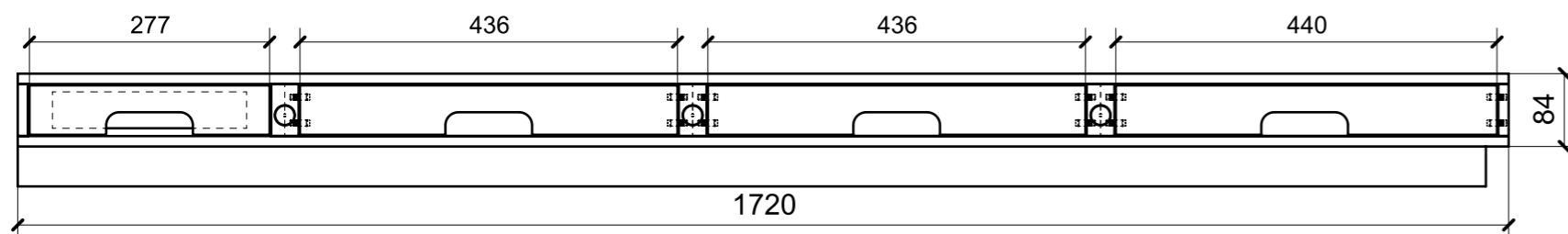
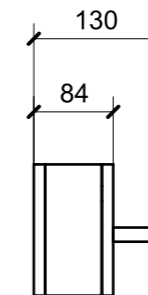
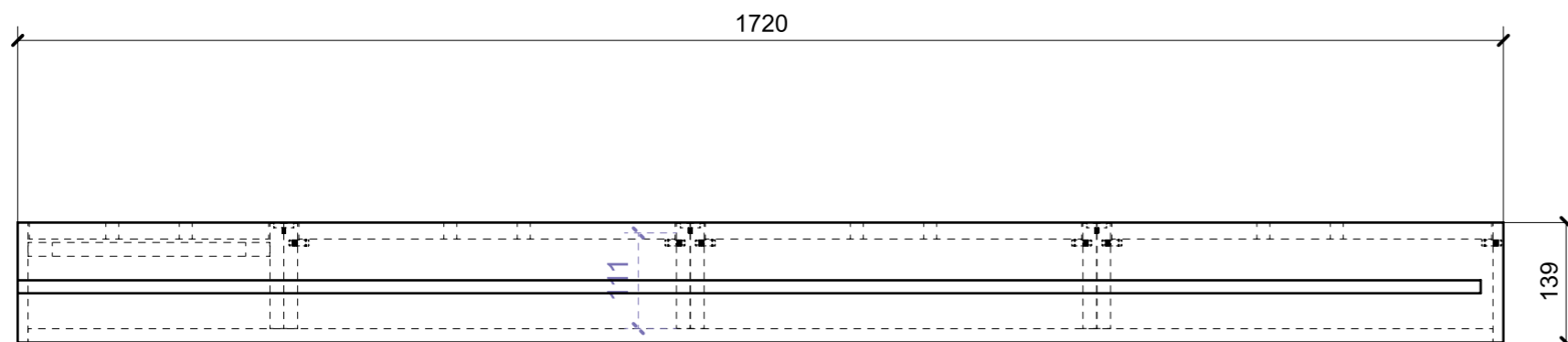
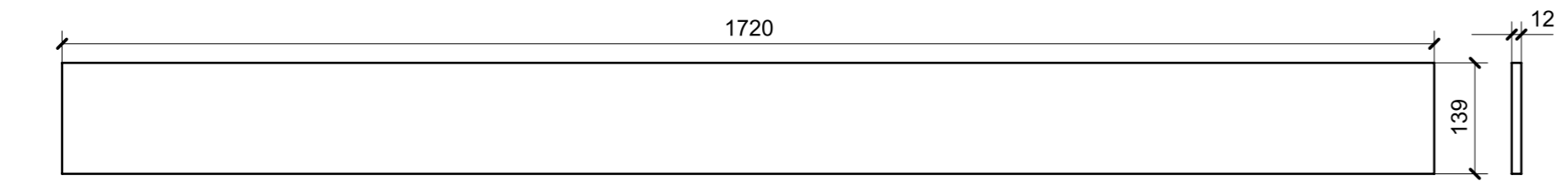

01

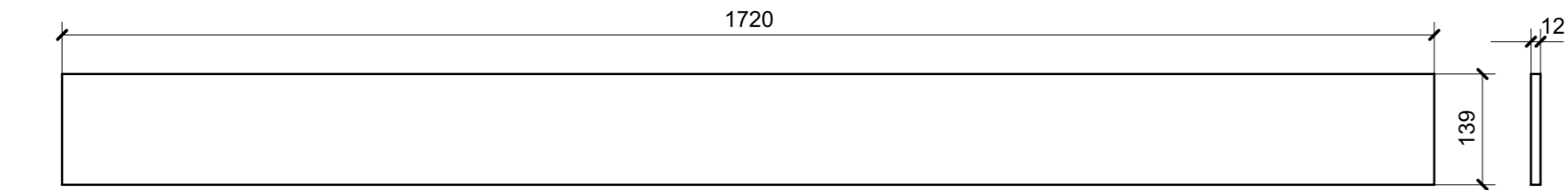

08

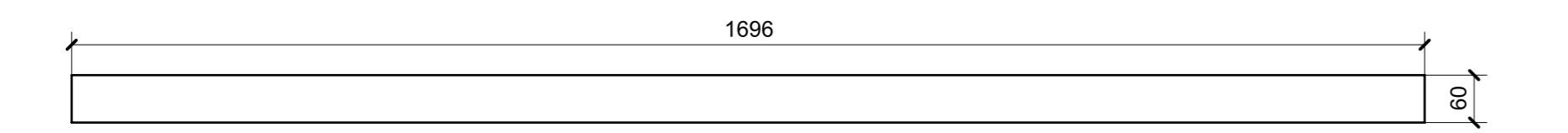

07

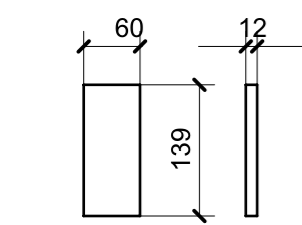

02

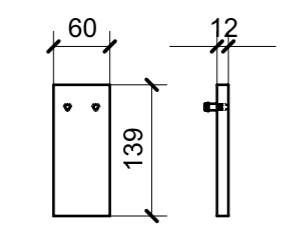

06

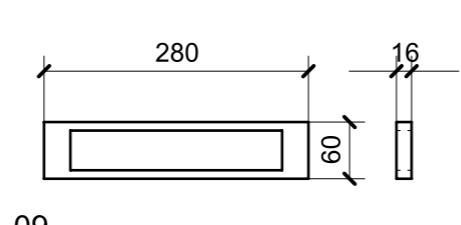

09

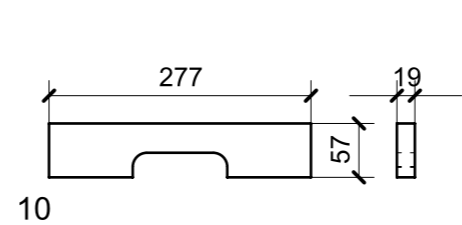

10

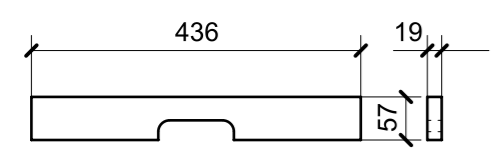

11

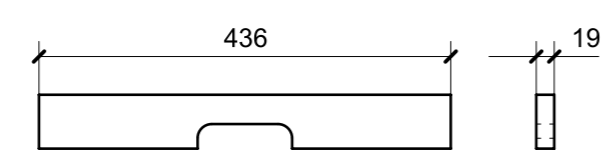

12

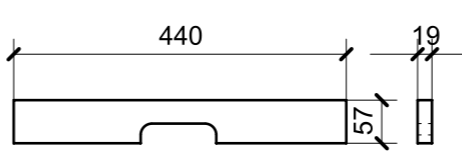

13

ELEMENTI DA MONTARE
con KF01_01 in MG_KF01
e spedire con unico imballo

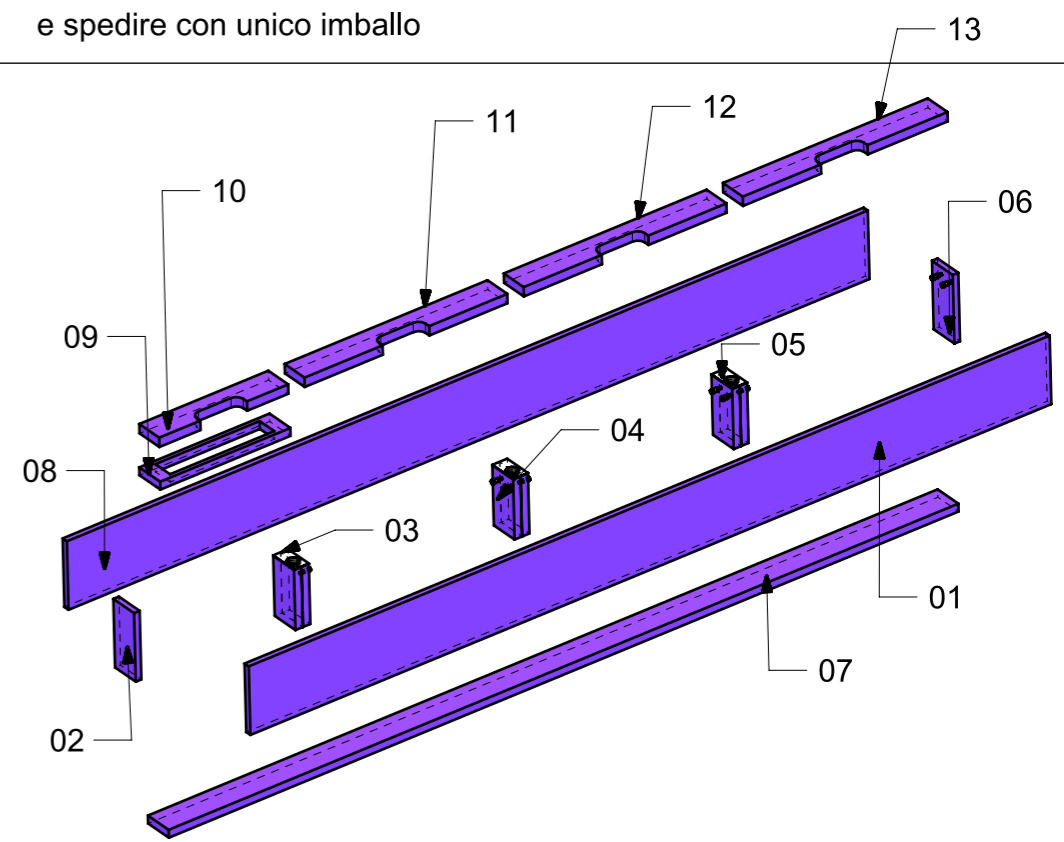
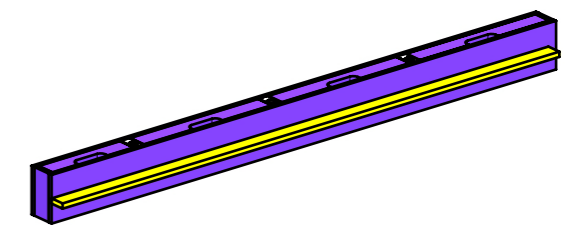

spessore 32

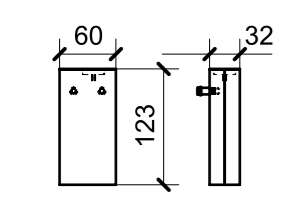

03

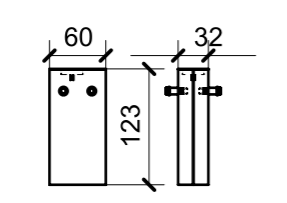

04

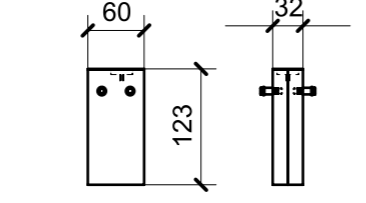

05

FERRAMENTA	QTY
MAGNETE FORZA MAGNETICA1-5 10KG_HAFELE_246.87.112	3
BUSSOLA RAPIDA_FBC BORGHI_00280877	12
REGGIRIPIANO PERNO RAPIDO X CR. CO-RING_FBC BORGHI_00073653	12