

LOCALE	CODICE	DESCRIZIONE COMPONENTE	FINITURA	Q.TA
BAGNO ARMATORE	MD298_X01_WI01	PAVIMENTO BAGNO	LAMINATO SM'ART A025 MAGNOLIA ANNAPURNA	1

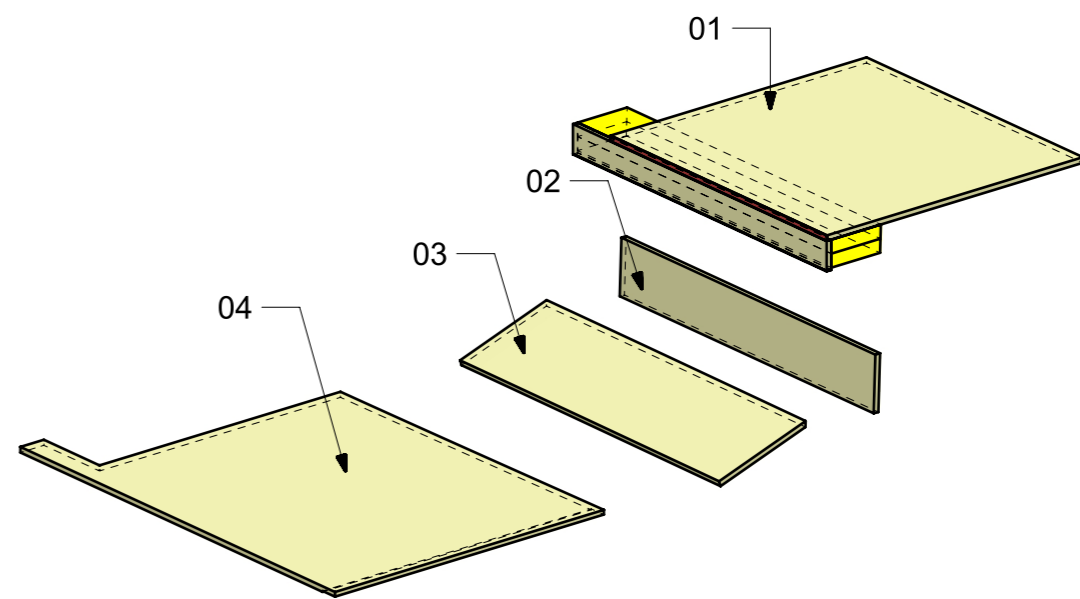

LOCALE	CODICE	DESCRIZIONE COMPONENTE	FINITURA	Q.TA
BAGNO ARMATORE	MD298_X01_WL01	CARABOTTINO DOCCIA	LAMINATO SM'ART A025 MAGNOLIA ANNAPURNA	1

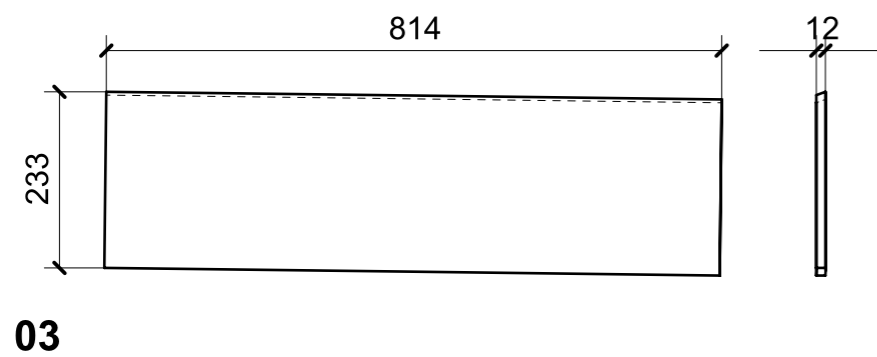
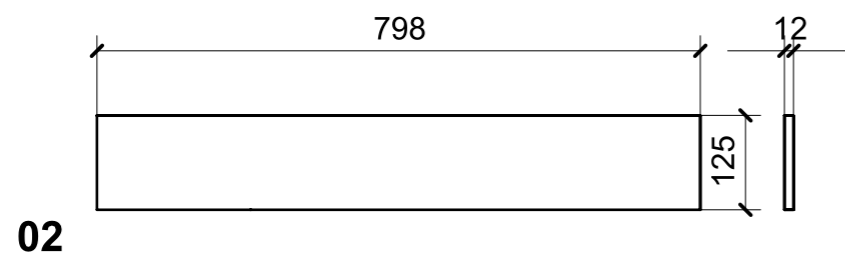
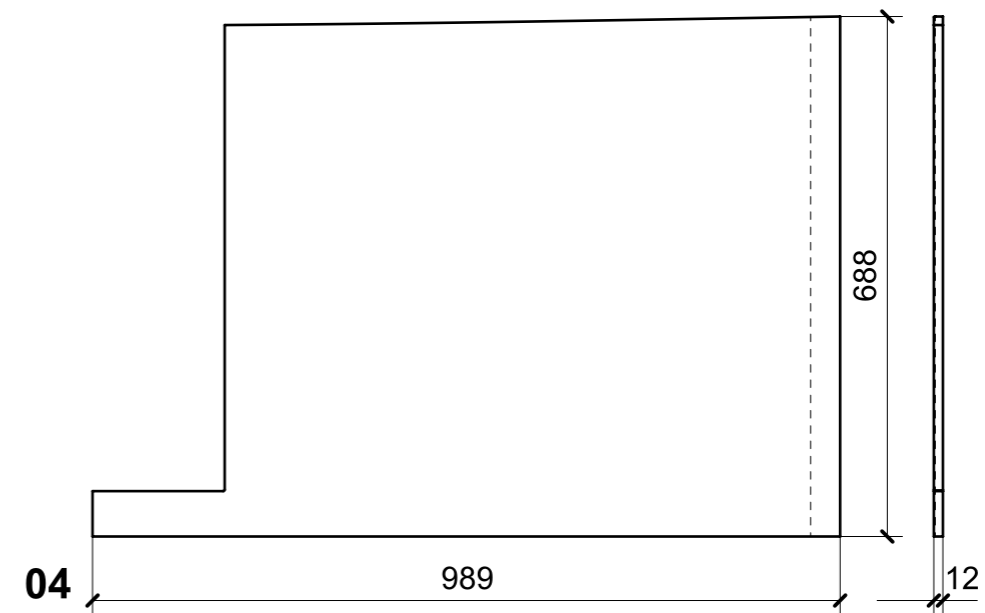
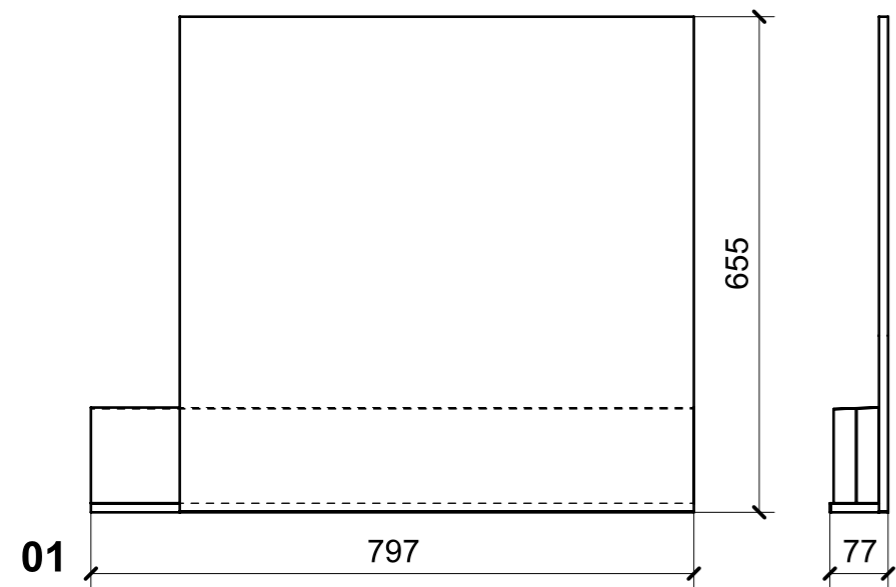
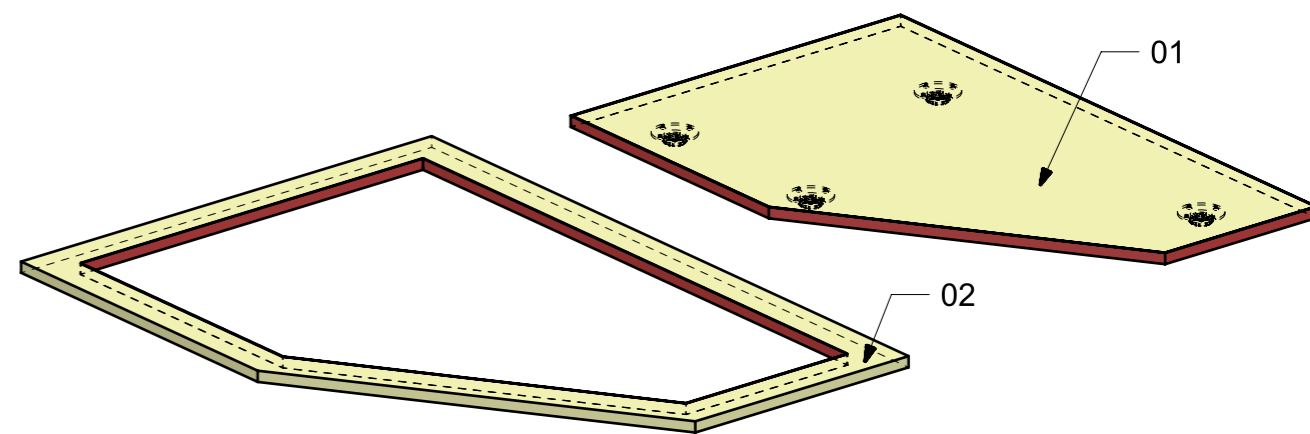
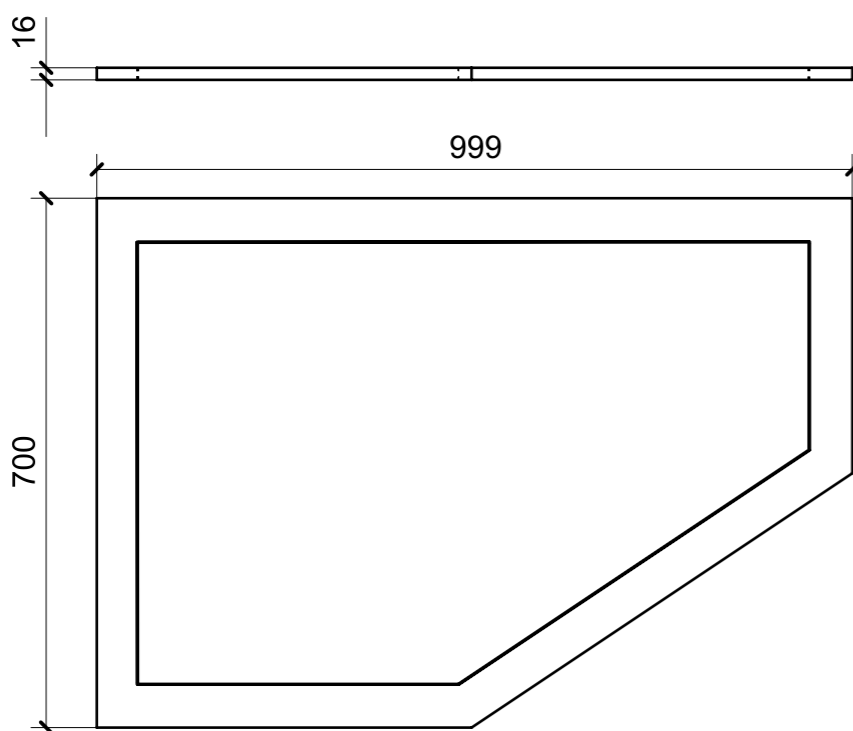
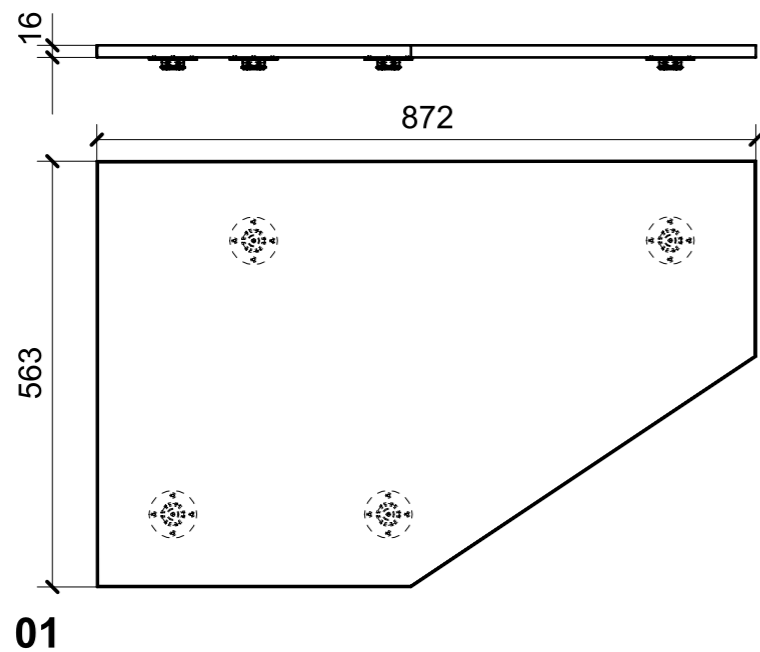

FERRAMENTA	QTY
FITLOCK M_MASCHERPA_3MM_6020202101	4

02