

LOCALE	CODICE	DESCRIZIONE COMPONENTE	FINITURA	Q.TA
CABINA OSPITI	MD298_X01_RD01	STRUTTURA MURATA	LAMINATO SM'ART 3104 CORDA LACCATA	1

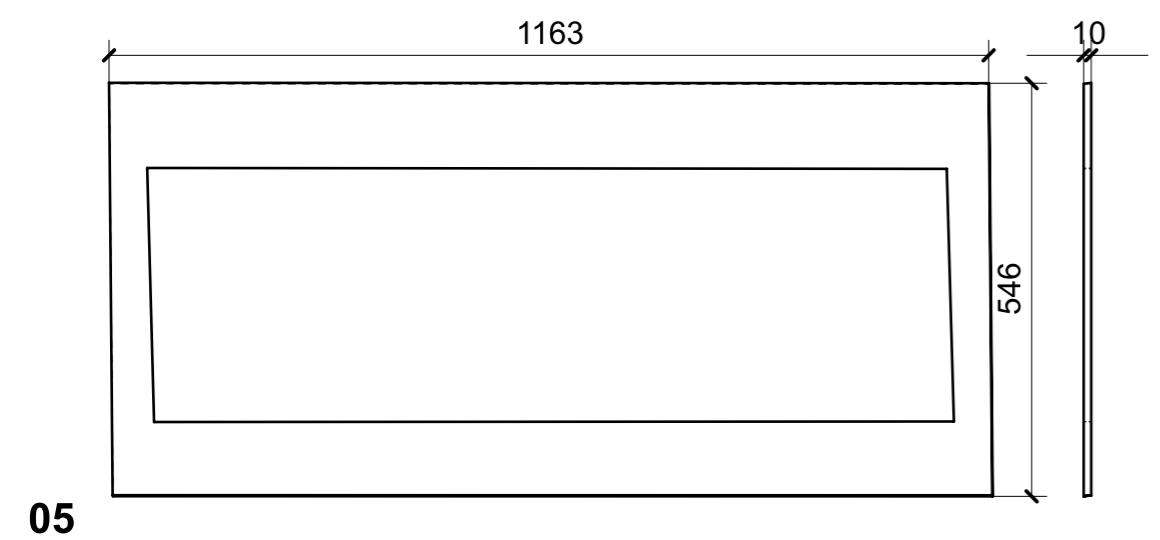

LOCALE	CODICE	DESCRIZIONE COMPONENTE	FINITURA	Q.TA
CABINA OSPITI	MD298_X01_RL01	CIELINO	LAMINATO SM'ART 3104 CORDA LACCATA	1

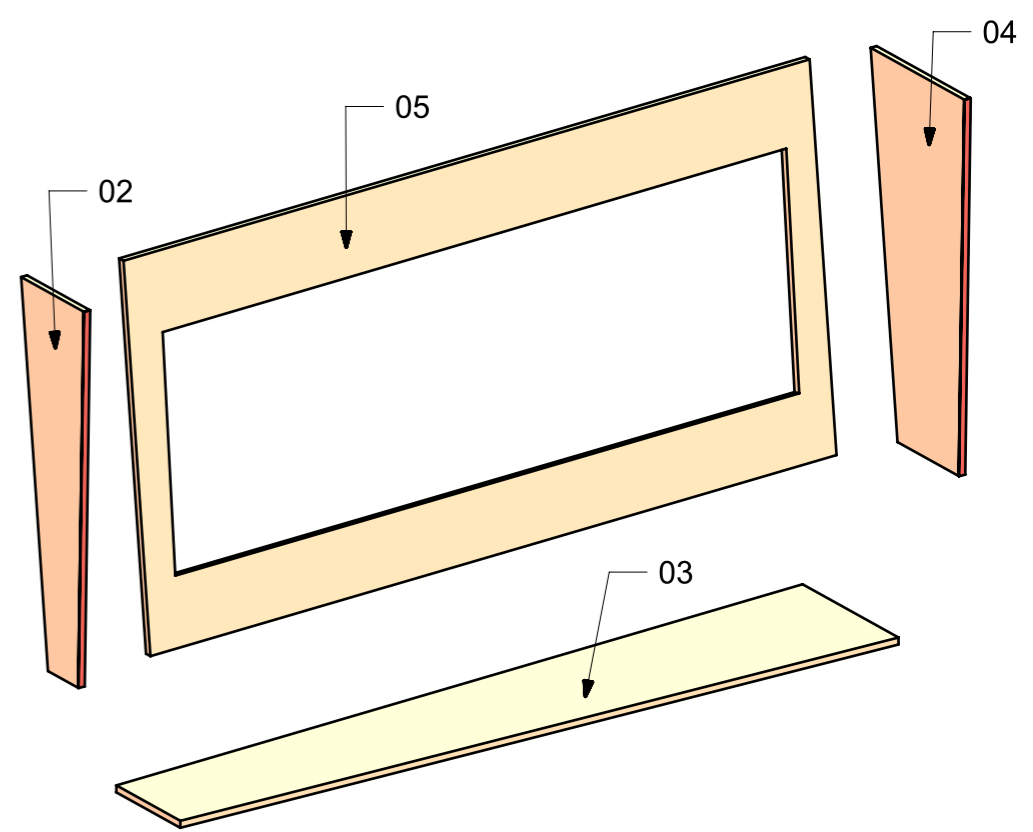
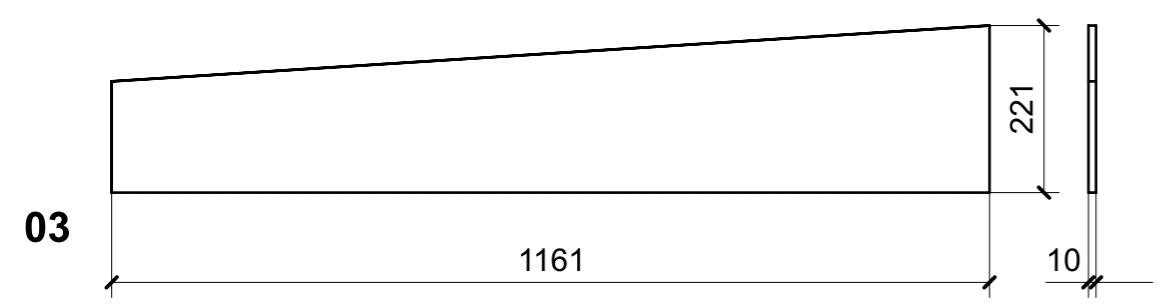
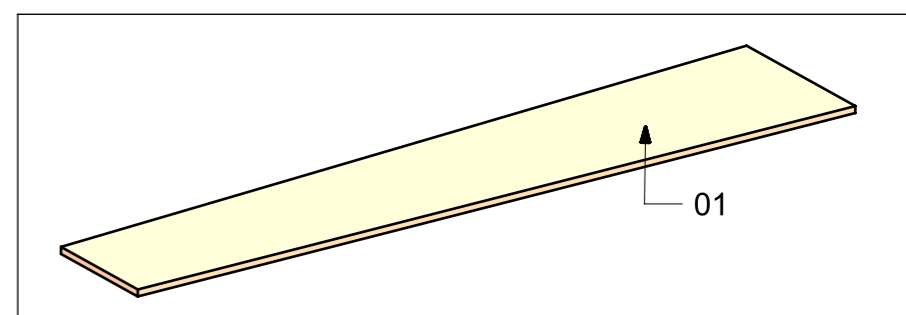
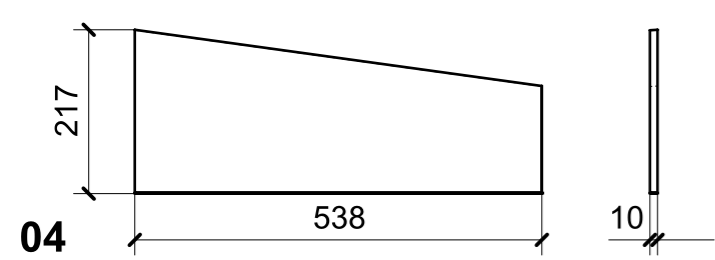
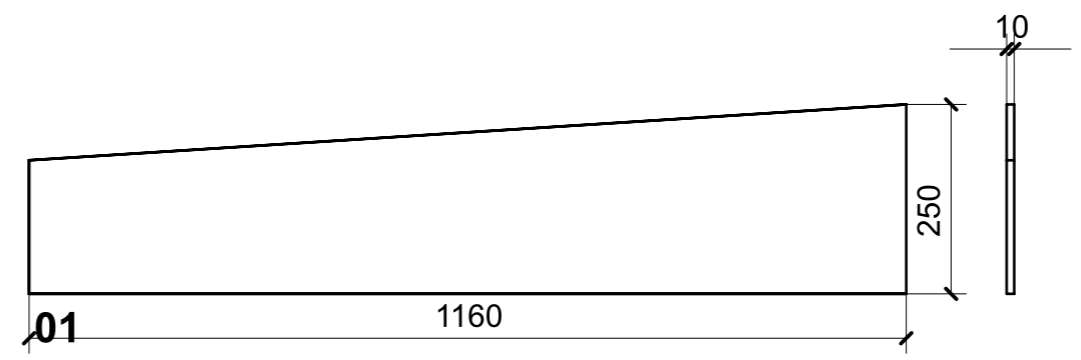
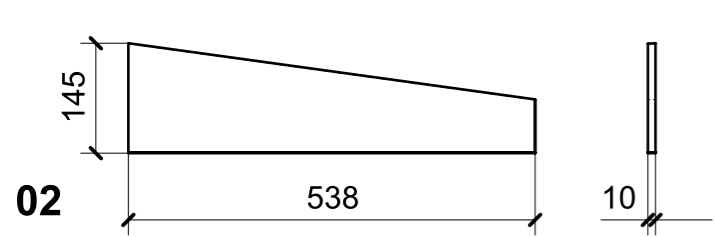