

LOCALE	CODICE	DESCRIZIONE COMPONENTE	FINITURA	GR
LOBBY	MD298_L01_CF01	MOBILE WINE COOLER	LACCATO BIANCO PERLA RAL 1013	8

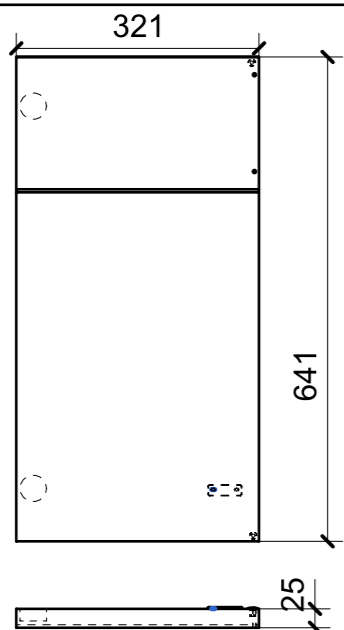

01

FERRAMENTA	QTY
GOMMINO PARACOLPO ANTA	2
PLACCHETTA COUNTER STEEL_TECHNOPARTNER_MC-JM49	1

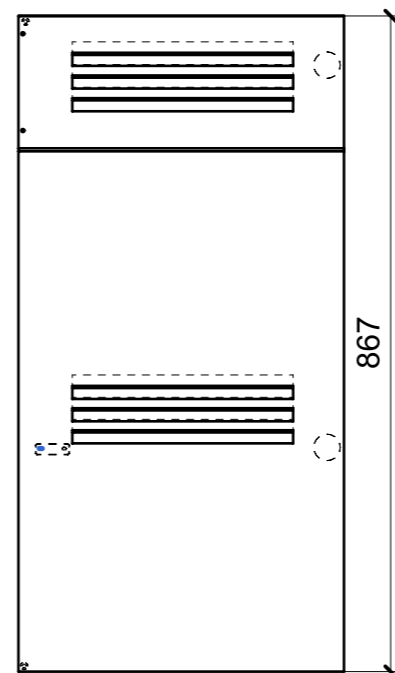

02

FERRAMENTA	QTY
GOMMINO PARACOLPO ANTA	2
PLACCHETTA COUNTER STEEL_TECHNOPARTNER_MC-JM49	1

01 02
ELEMENTI DA MONTARE
con CF01_01-->05 in MF_CF01
e spedire con unico imballo

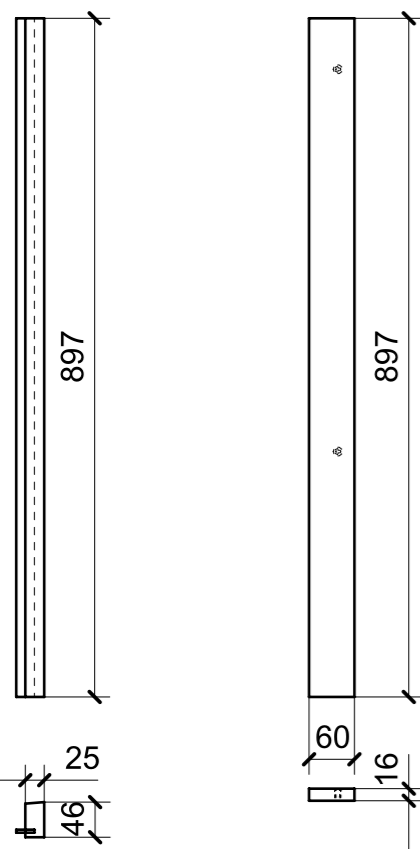
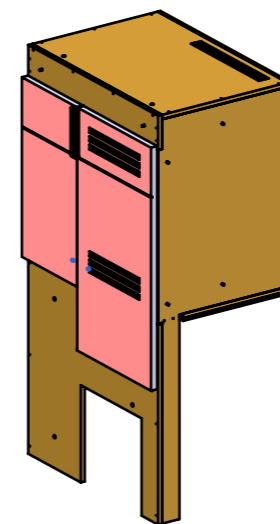

04

05

FERRAMENTA	QTY
BUSSOLA 5MA X 10 FORO DIAM.8	2

ELEMENTI DA MONTARE
in MG_CF01
e spedire con unico imballo

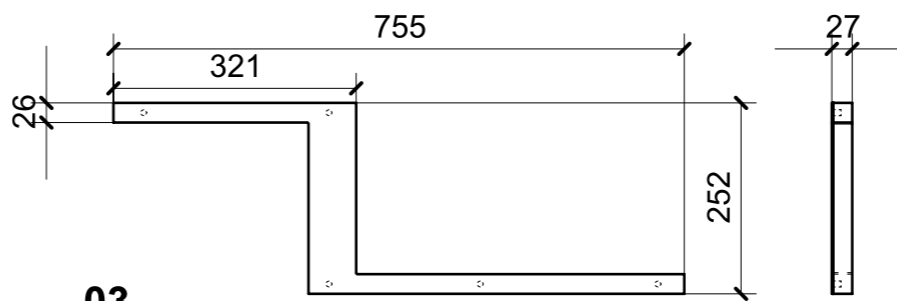

03

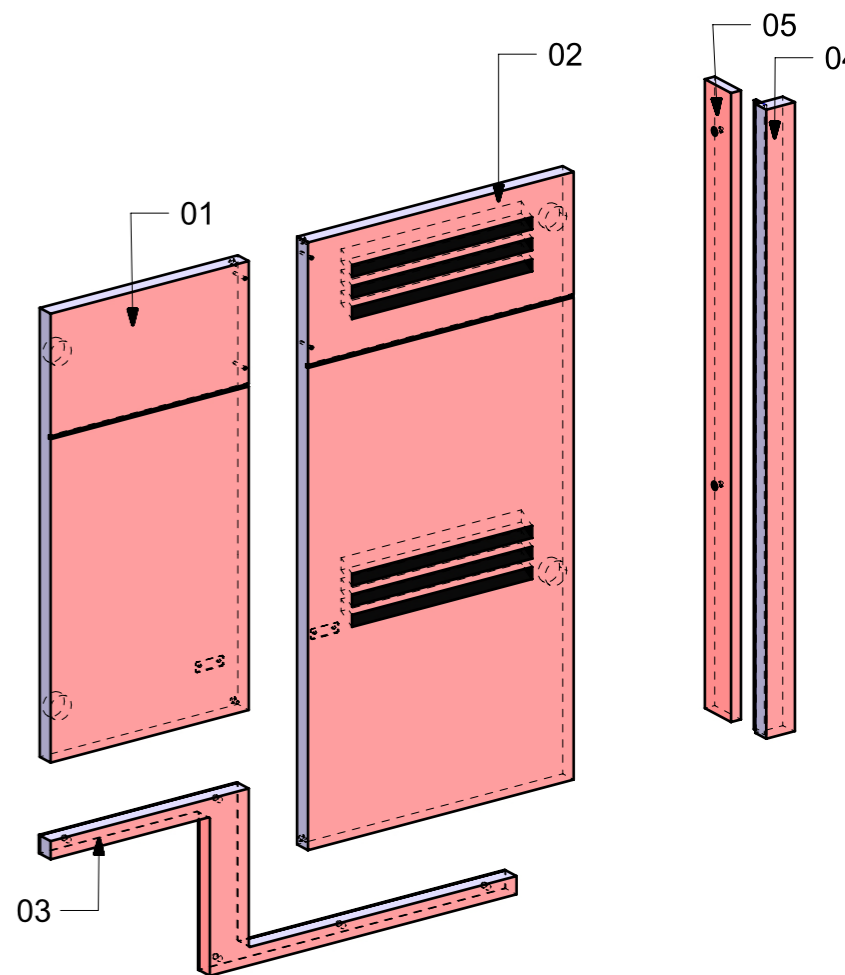

VERNICIATURA LASTRA/LACCATI:

● = VERNICIARE 1 LATO + FILI RASATI O BORDATI

NESSUN SIMBOLO = VERNICIARE 2 LATI + FILI RASATI O BORDATI

LOCALE	CODICE	DESCRIZIONE COMPONENTE	FINITURA	Q.TA
LOBBY	MD298_L01_CG01	MONTANTE VERTICALE MOBILE SOTTOSCALA	LACCATO BIANCO PERLA RAL 1013	1

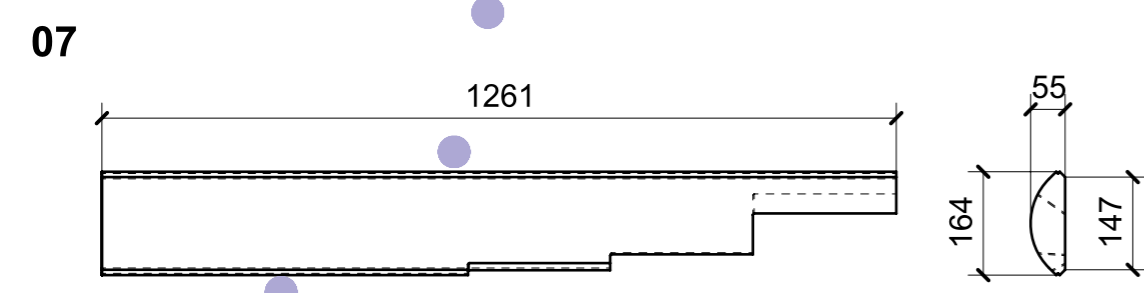
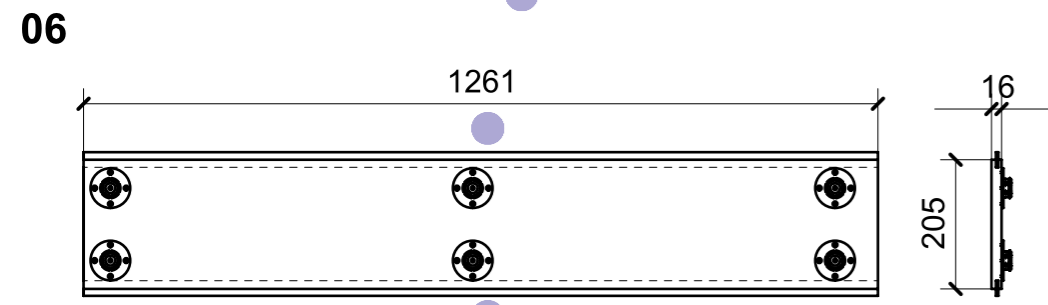
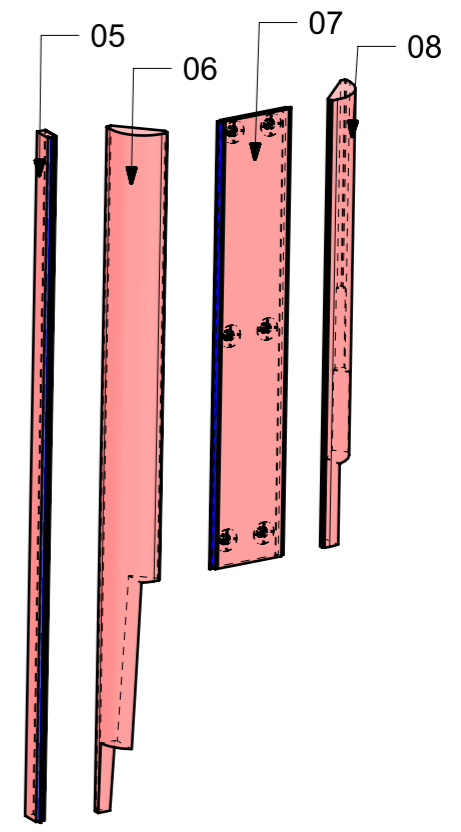
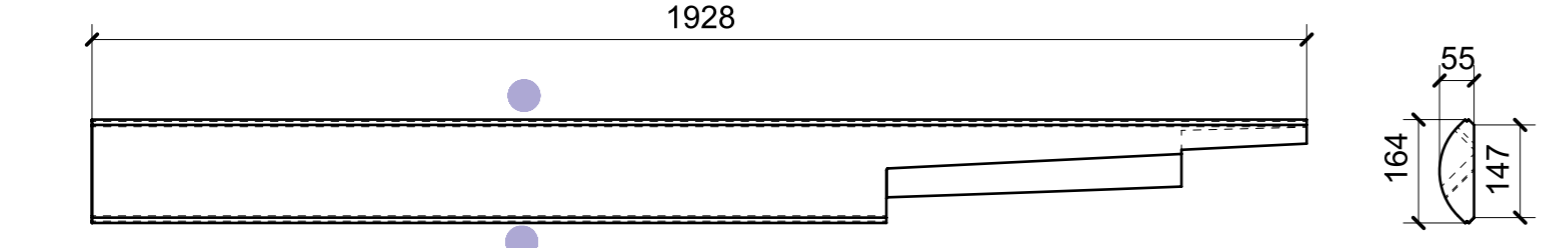
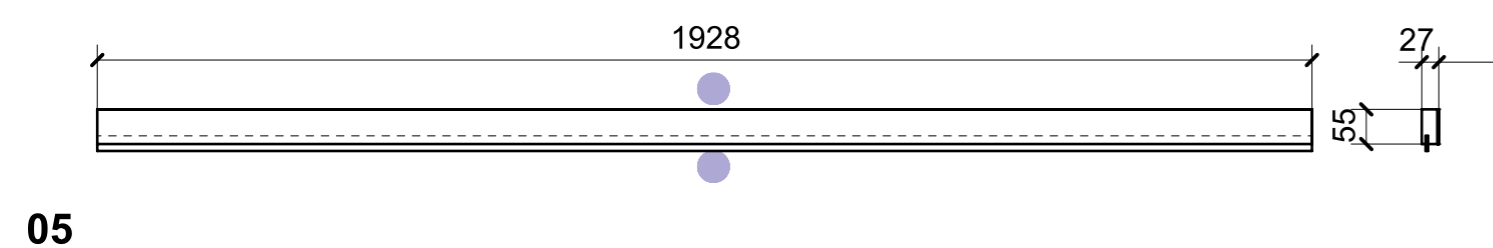
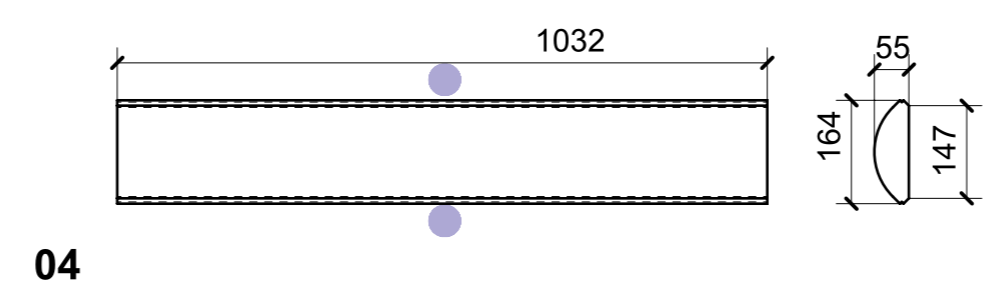
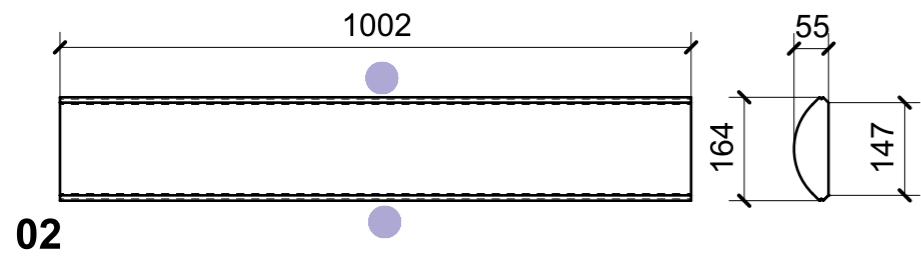
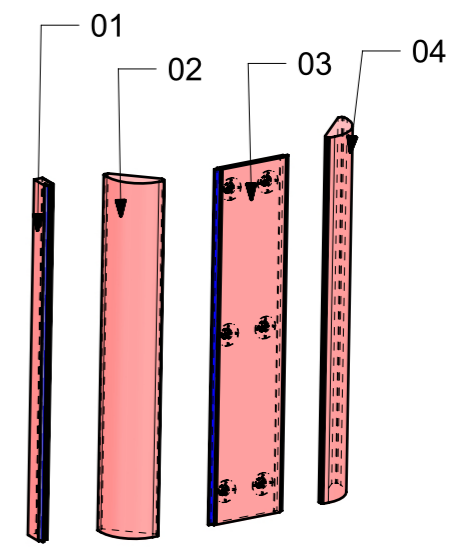
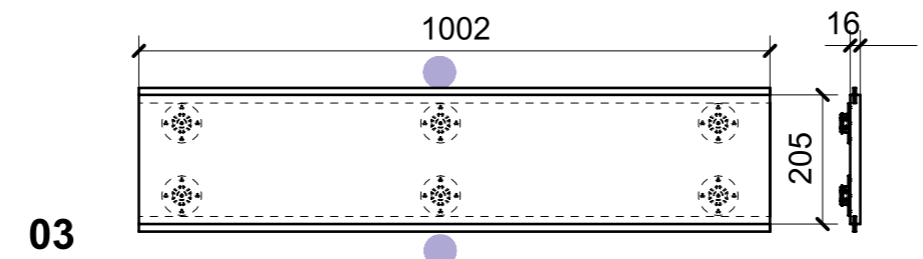
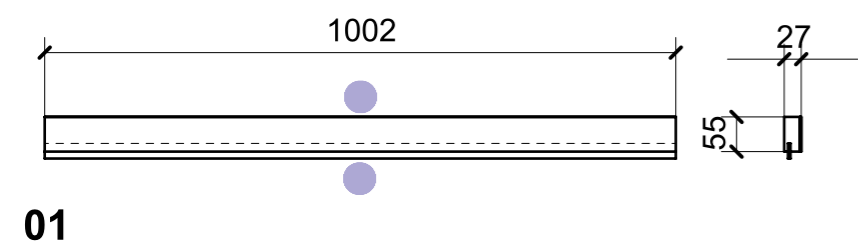

VERNICIATURA LASTRA/LACCATI:
 ● = VERNICIARE 1 LATO + FILI RASATI O BORDATI
 NESSUN SIMBOLO = VERNICIARE 2 LATI + FILI RASATI O BORDATI

LOCALE	CODICE	DESCRIZIONE COMPONENTE	FINITURA	Q.TA
LOBBY	MD298_L01_CI01	RIV. PARETE SX DISCESA SCALA	LACCATO BIANCO PERLA RAL 1013	1

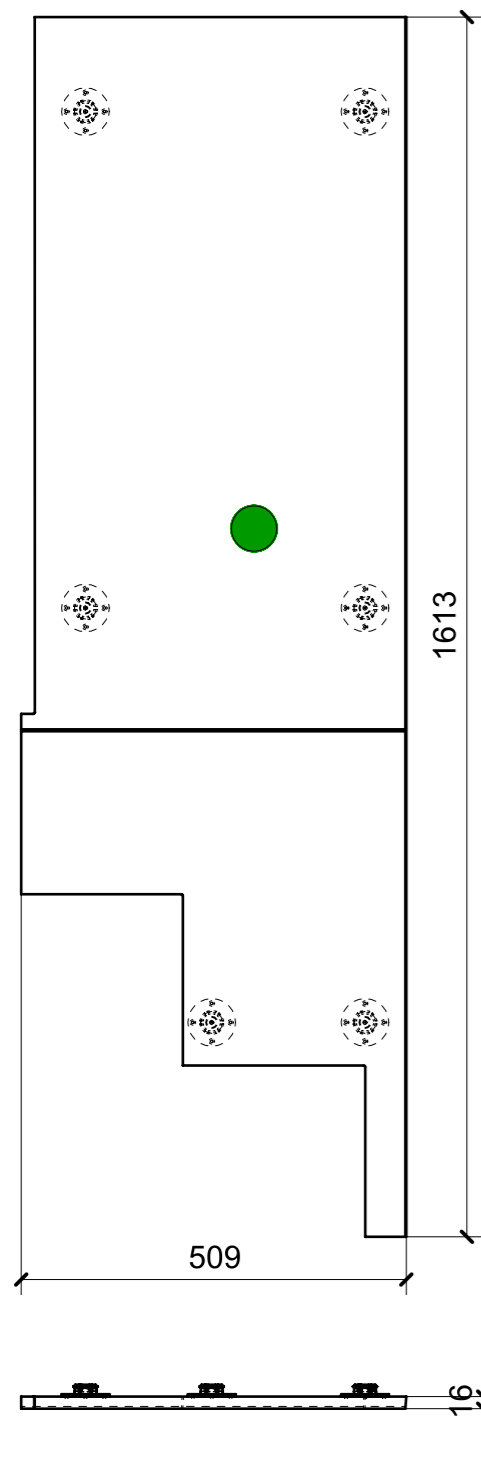

01

FERRAMENTA	QTY
FITLOCK M_MASCHERPA_3MM_6020202101	6

02

FERRAMENTA	QTY
BUSSOLA 5MA X 10 FORO DIAM.8	2

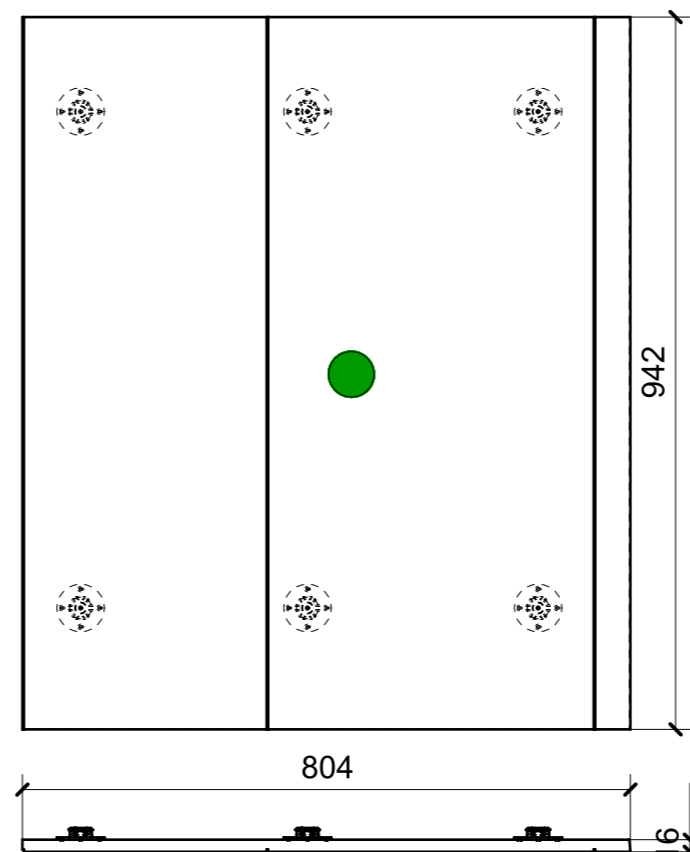
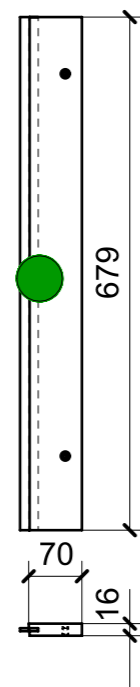

03

FERRAMENTA	QTY
FITLOCK M_MASCHERPA_3MM_6020202101	6

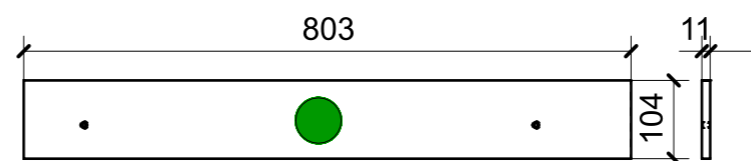

04

FERRAMENTA	QTY
BUSSOLA 5MA X 10 FORO DIAM.8	2

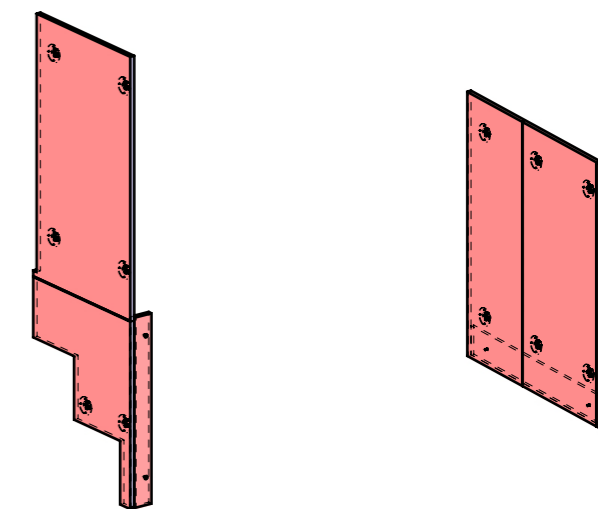

ELEMENTI DA MONTARE
in MG_CI01
e spedire con unico imballo

ELEMENTI DA MONTARE
in MG_CI02
e spedire con unico imballo

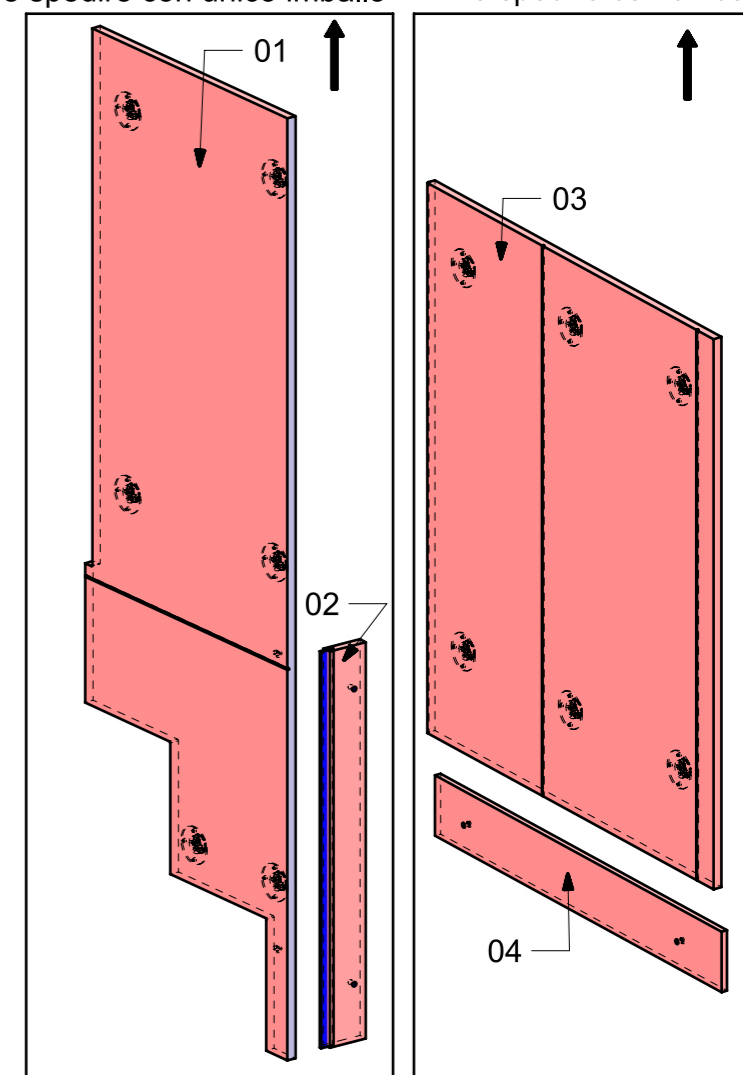

VERNICIATURA LASTRA/LACCATI:

● = VERNICIARE 1 LATO + FILI RASATI O BORDATI

NESSUN SIMBOLO = VERNICIARE 2 LATI + FILI RASATI O BORDATI

LOCALE	CODICE	DESCRIZIONE COMPONENTE	FINITURA	Q.TA
LOBBY	MD298_L01_CL01	RIV. PARETE DX DISCESA SCALA	LACCATO BIANCO PERLA RAL 1013	1

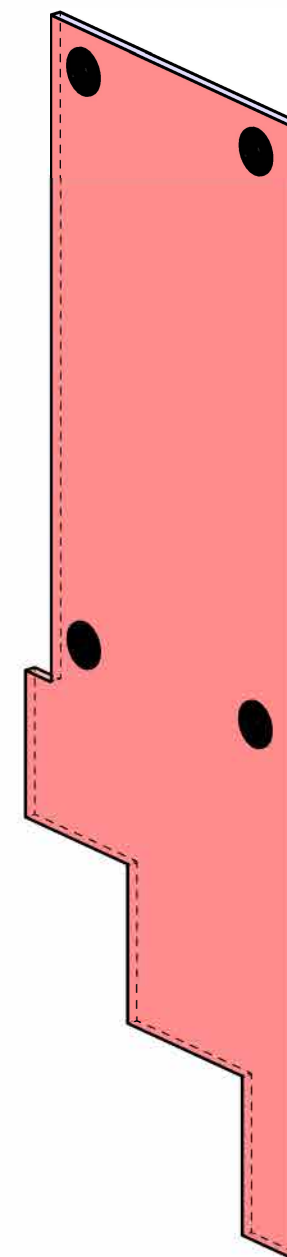
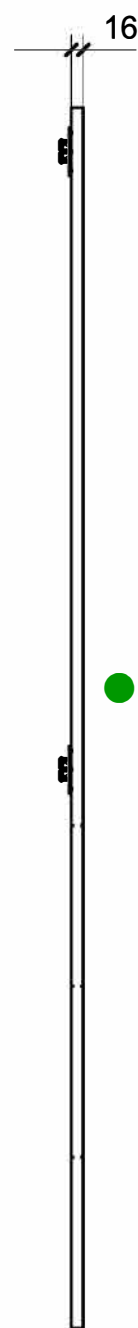
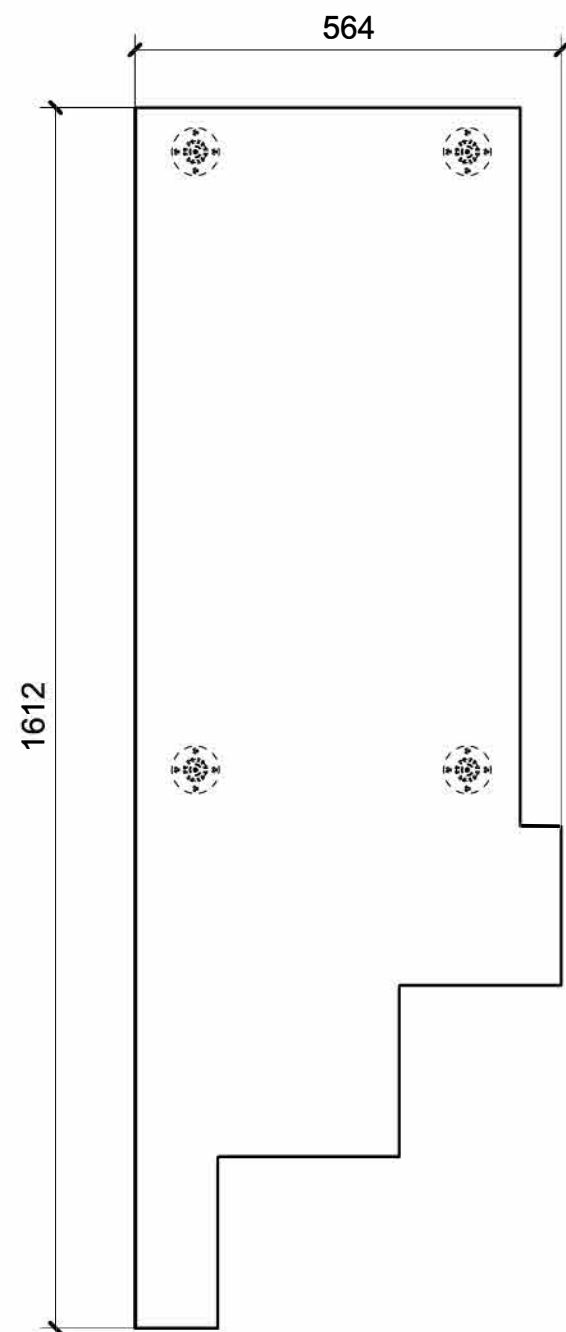

FERRAMENTA	QTY
FITLOCK M_MASCHERPA_3MM_6020202101	4

VERNICIATURA LASTRA/LACCATI:

● = VERNICIARE 1 LATO + FILI RASATI O BORDATI

NESSUN SIMBOLO = VERNICIARE 2 LATI + FILI RASATI O BORDATI

LOCALE	CODICE	DESCRIZIONE COMPONENTE	FINITURA	Q.TA
LOBBY	MD298_L01_CM01	RIV. PARETE FRONTE DISCESA SCALA	LACCATO BIANCO PERLA RAL 1013	1

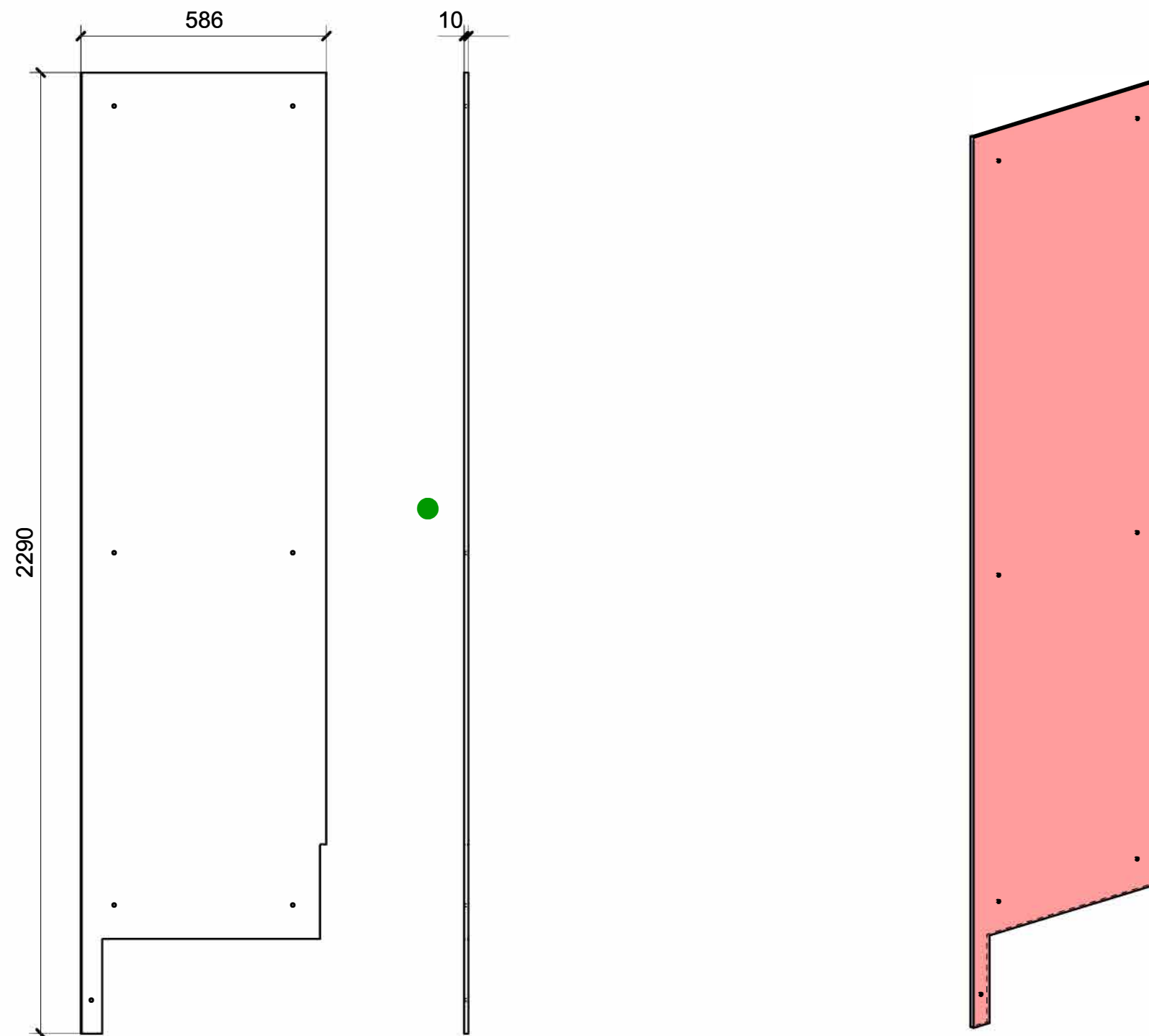

VERNICIATURA LASTRA/LACCATI:

● = VERNICIARE 1 LATO + FILI RASATI O BORDATI

NESSUN SIMBOLO = VERNICIARE 2 LATI + FILI RASATI O BORDATI