

LOCALE	CODICE	DESCRIZIONE COMPONENTE	FINITURA	Q.TA
CUCINA	MD298_L01_KA01	BASE CUCINA	LACCATO SERIE 90 MFY-01.02	1

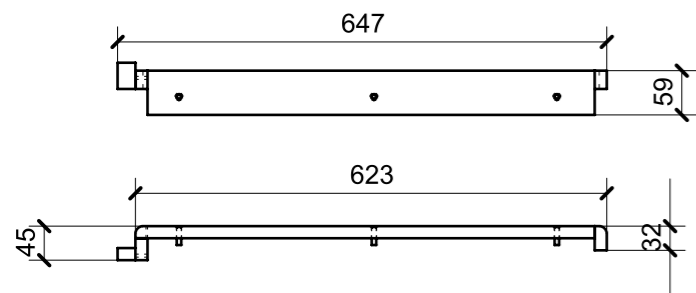

FERRAMENTA	QTY
VITE 6MA X 25 TESTA SVASATA	3

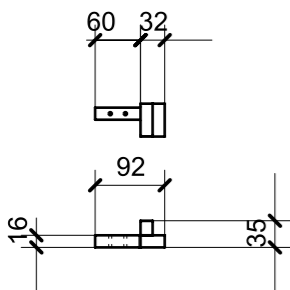

02

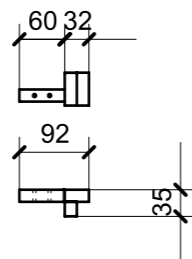

03

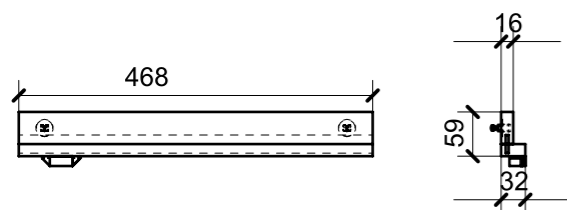

FERRAMENTA	QTY
MS INCASSO_ITALVIPLA_972_FMPC_M1B	2
CALAMITA SEALED MAGNETIC_TECNOPARTNER_MC-JM50-BL	1

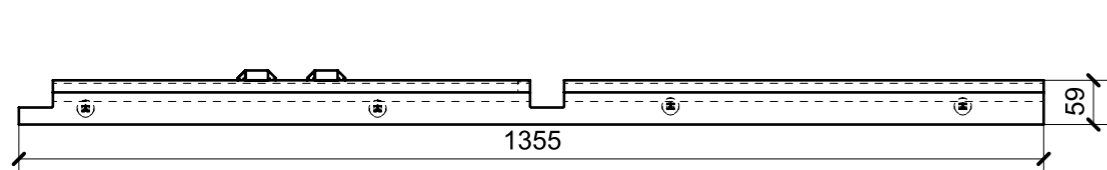

FERRAMENTA	QTY
MS INCASSO_ITALVIPLA_972_FMPC_M1B	4
CALAMITA SEALED MAGNETIC_TECNOPARTNER_MC-JM50-BL	2

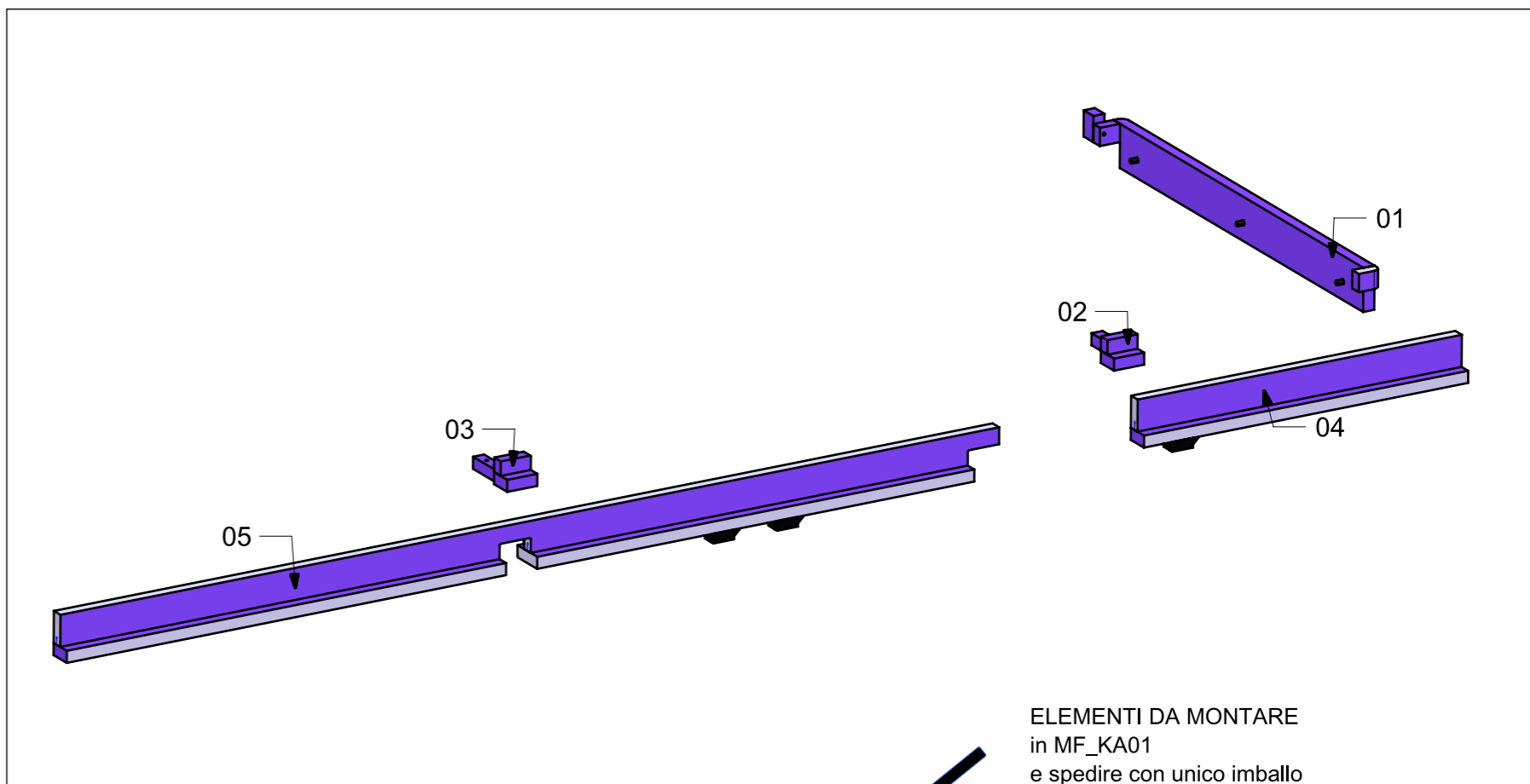

ELEMENTI DA MONTARE
in MF_KA01
e spedire con unico imballo

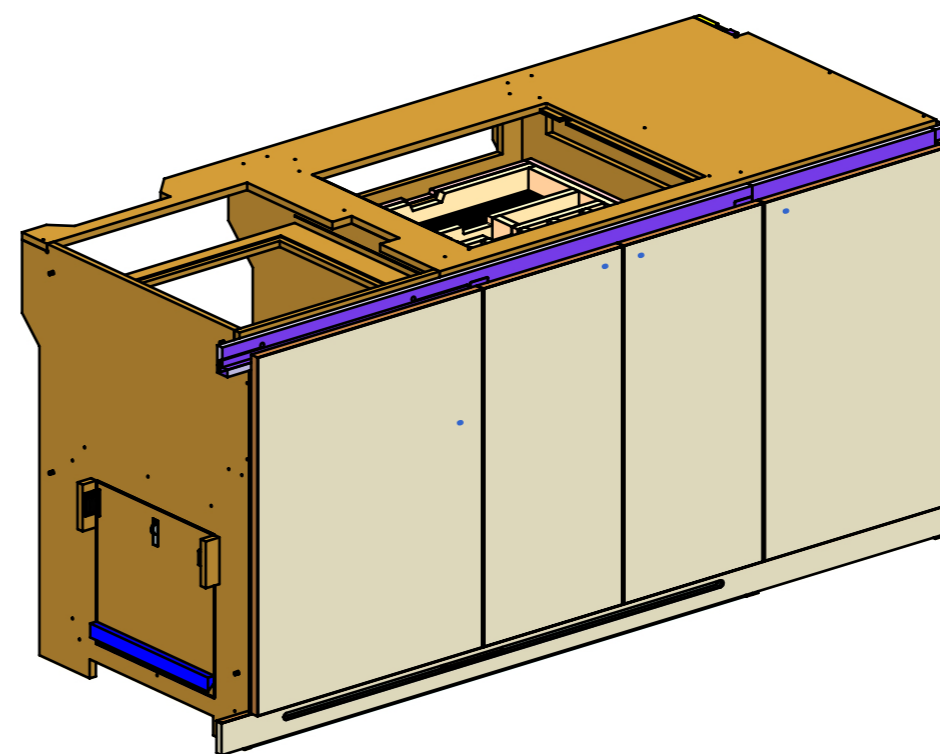

VERNICIATURA LASTRA/LACCATI:

● = VERNICIARE 1 LATO + FILI RASATI O BORDATI

NESSUN SIMBOLO = VERNICIARE 2 LATI + FILI RASATI O BORDATI

LOCALE	CODICE	DESCRIZIONE COMPONENTE	FINITURA	GR
CUCINA	MD298_L01_KF01	PORTA OGGETTI CUCINA	LACCATO SERIE 90 MFY-01.02	8

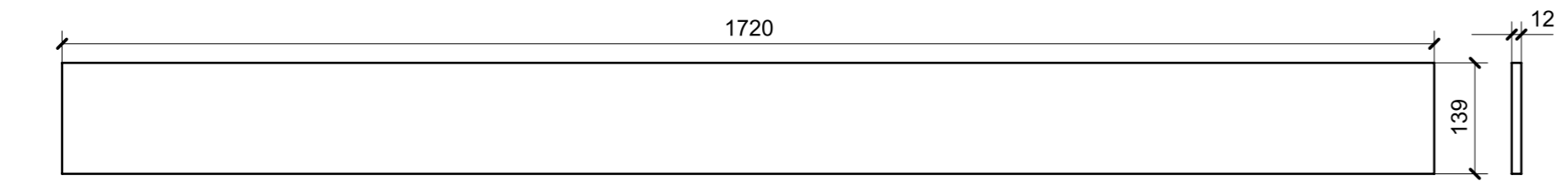

01

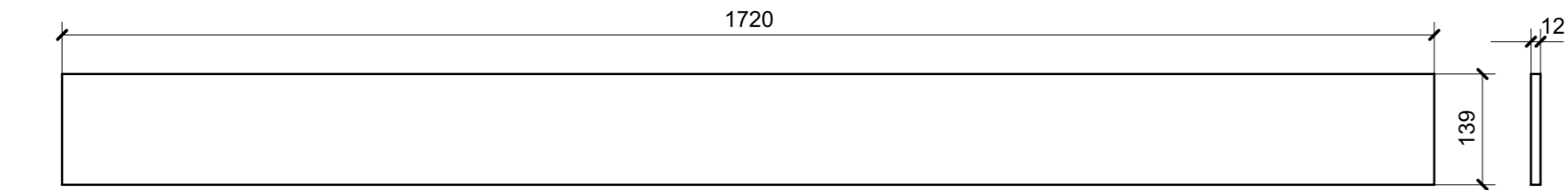

08

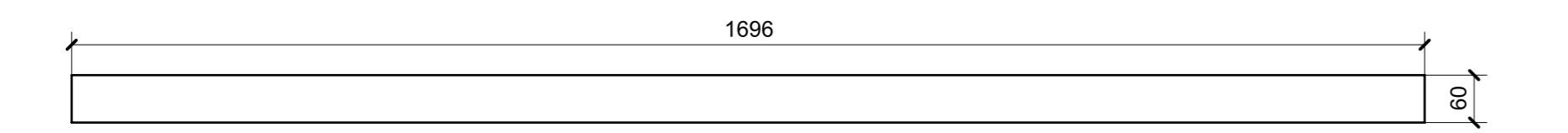

07

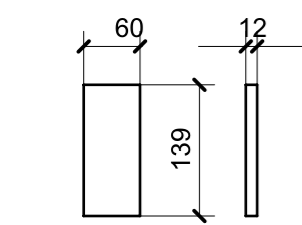

02

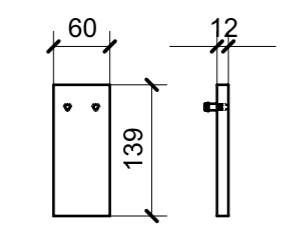

06

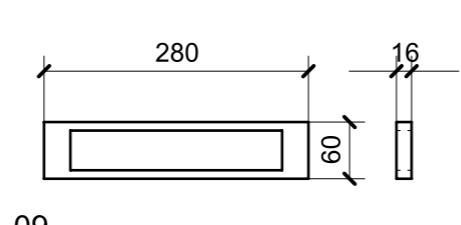

09

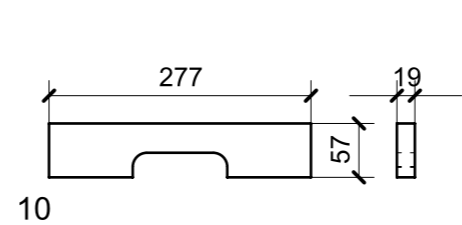

10

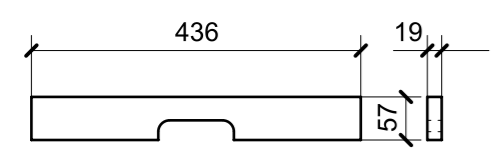

11

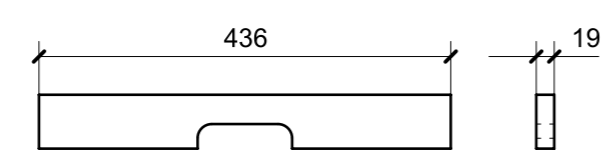

12

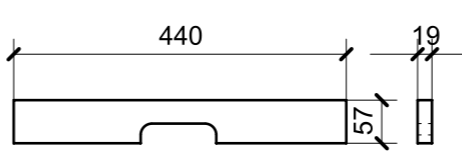

13

spessore 32

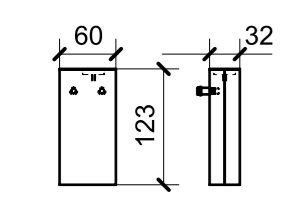

03

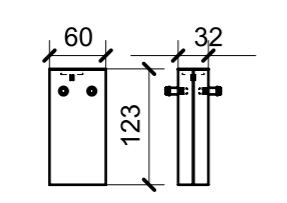

04

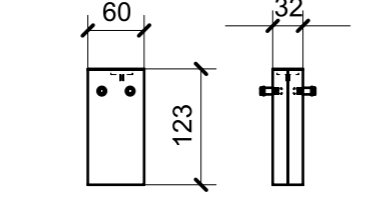

05

ELEMENTI DA MONTARE
con KF01_01 in MG_KF01
e spedire con unico imballo

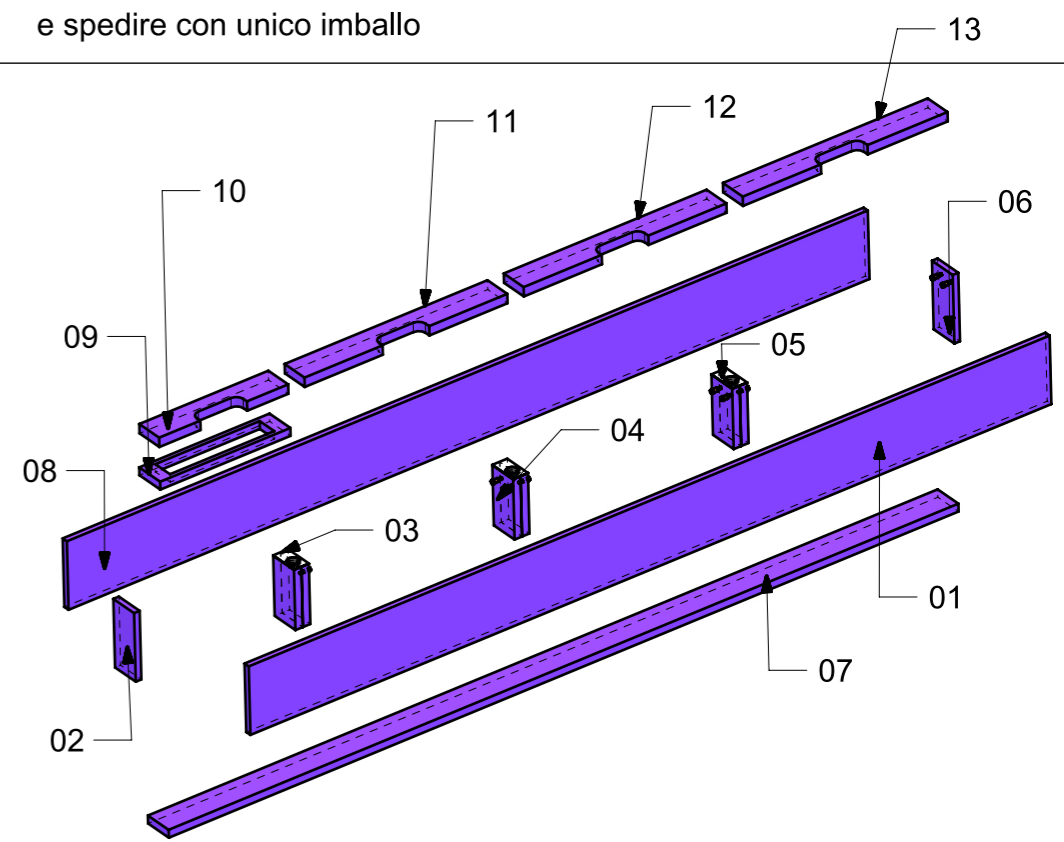
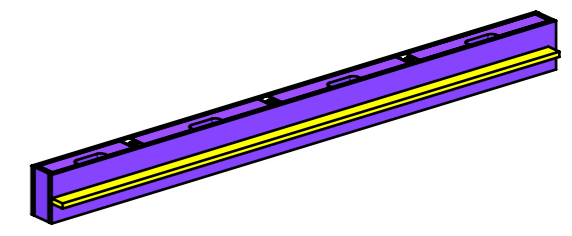

FERRAMENTA	QTY
MAGNETE FORZA MAGNETICA1-5 10KG_HAFELE_246.87.112	3
BUSSOLA RAPIDA_FBC BORGHI_00280877	12
REGGIRIPIANO PERNO RAPIDO X CR. CO-RING_FBC BORGHI_00073653	12