

| LOCALE          | CODICE            | DESCRIZIONE COMPONENTE | FINITURA                       | Q.TA |
|-----------------|-------------------|------------------------|--------------------------------|------|
| CABINA ARMATORE | MD299_A04_AA01_01 | ARMADIO SX PRUA        | ACCIAIO SATINATO BRONZO AUDREY | 1    |

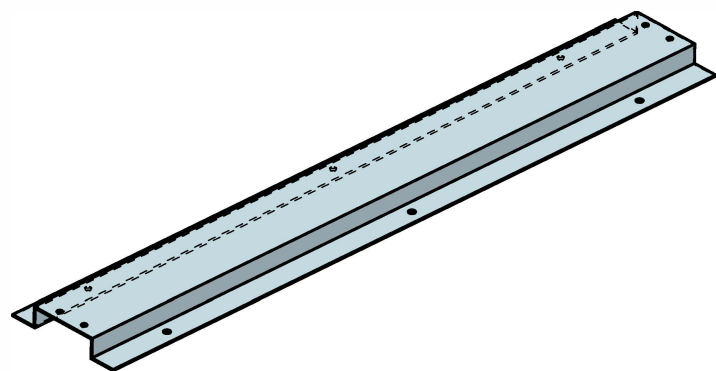

| LOCALE | CODICE      | DESCRIZIONE COMPONENTE | FINITURA     | Q.TA |
|--------|-------------|------------------------|--------------|------|
| PORTE  | MD299_MG_P1 | PORTA CAB ARMATORE     | LASTRA SCURA | 1    |

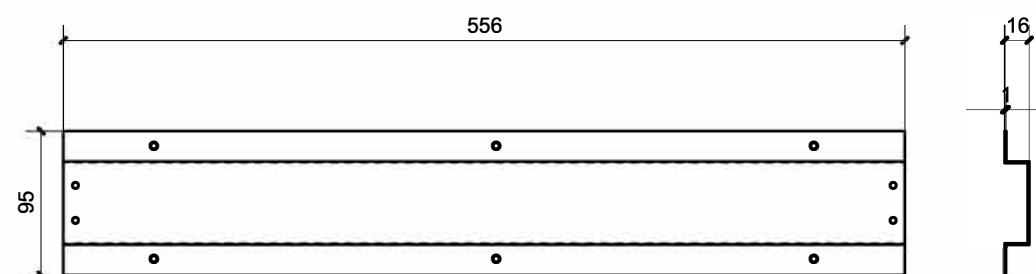
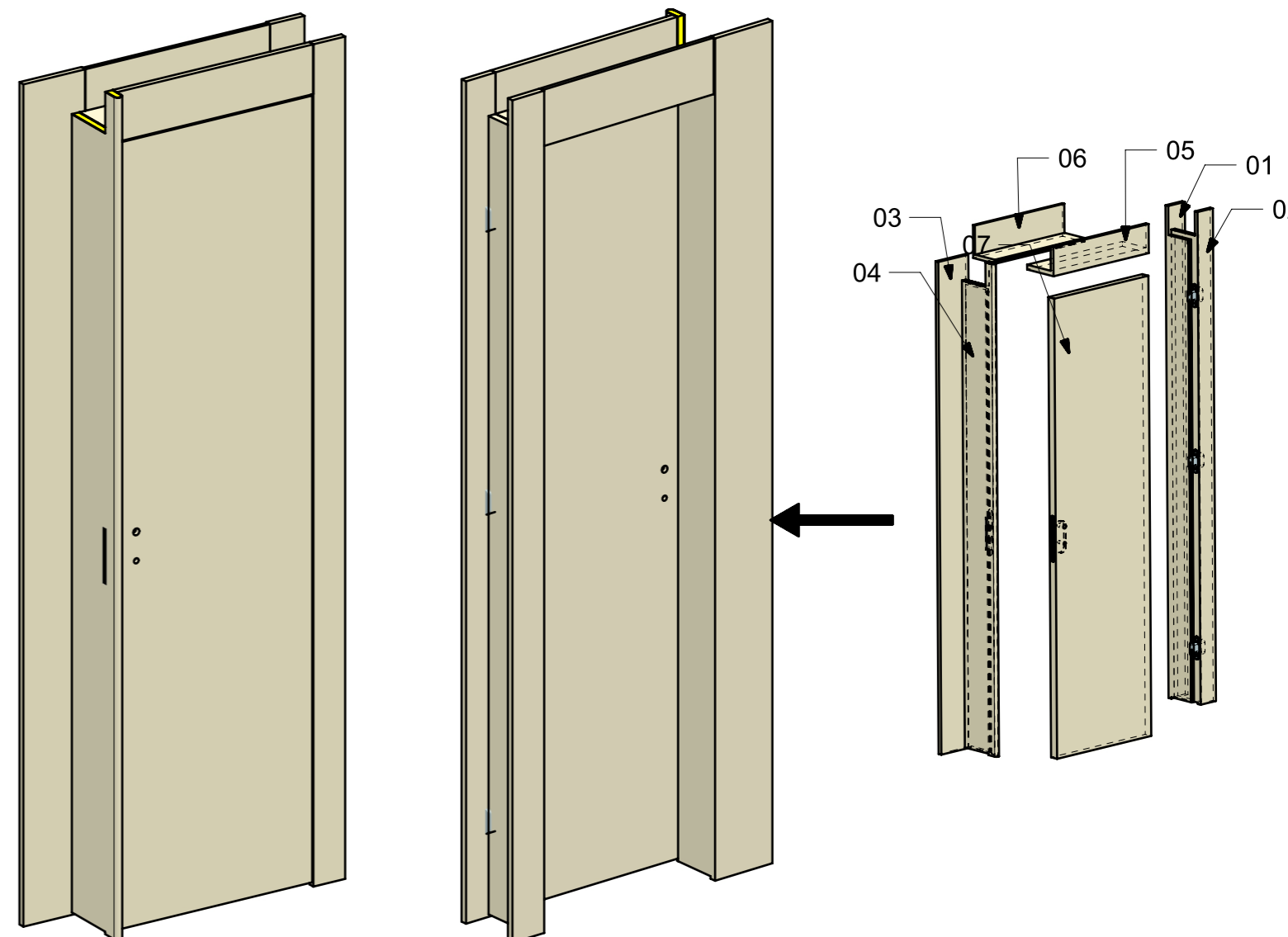
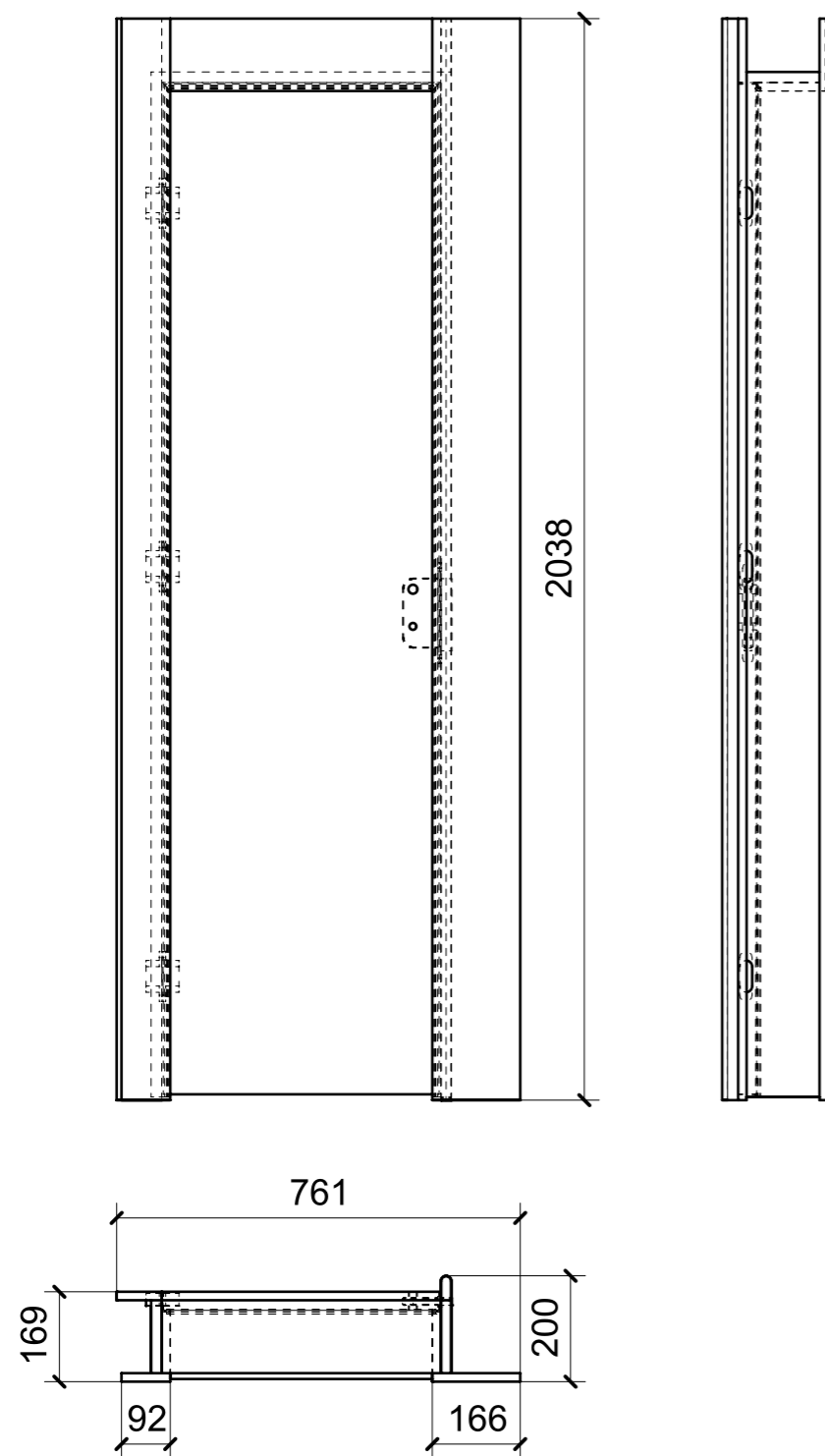

| FERRAMENTA  | QTY |
|---|-----|
| CERNIERA INVISIBILE KOBLENZ_FBC_COD K6200 20 CL                 | 3   |
| CONTROPIASTRA MAGNETICA CROMO LUCIDO 992 CR L_FBC               | 1   |
| SERRATURA MAGNETICA B-ONE CROMATO LUCIDO 901 (INTERASSE 70)_FBC | 1   |

VERNICIATURA LASTRA/LACCATI:

● = VERNICIARE 1 LATO + FILI RASATI O BORDATI

NESSUN SIMBOLO = VERNICIARE 2 LATI + FILI RASATI O BORDATI

| LOCALE | CODICE       | DESCRIZIONE COMPONENTE | FINITURA     | Q.TA |
|--------|--------------|------------------------|--------------|------|
| PORTE  | MD299_R01_P1 | PORTA CAB ARMATORE     | LASTRA SCURA | 1    |

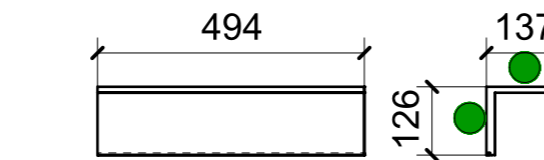
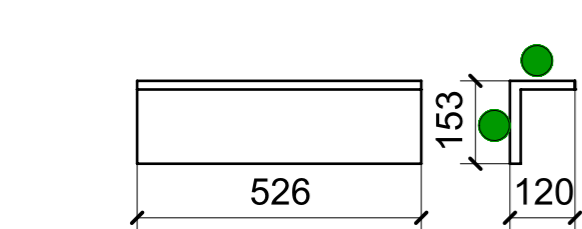
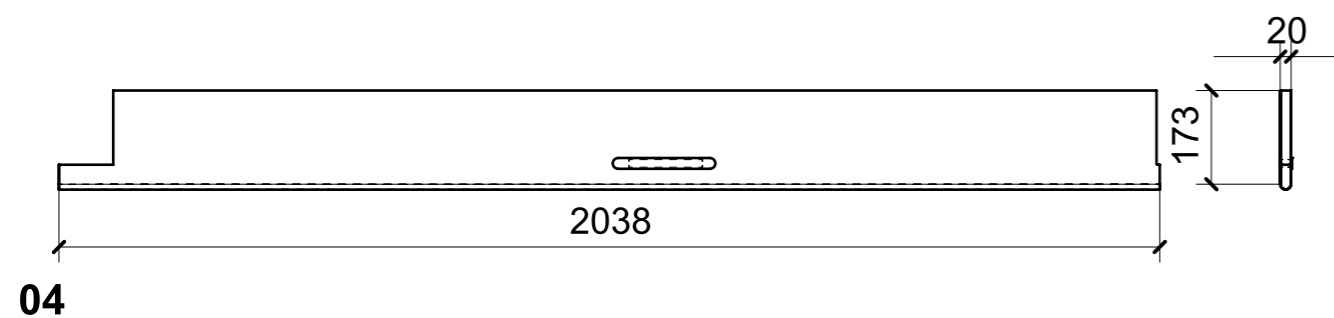
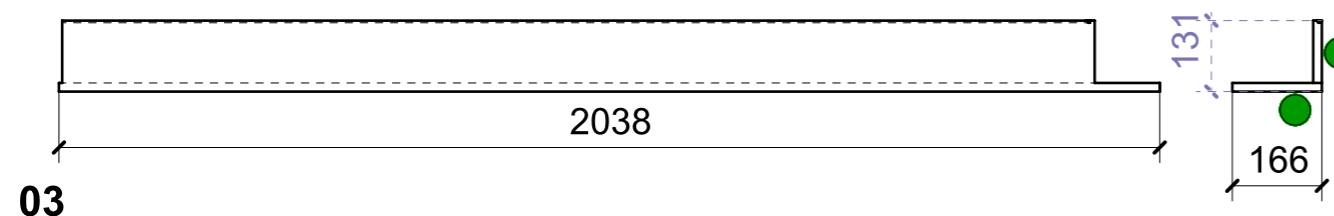
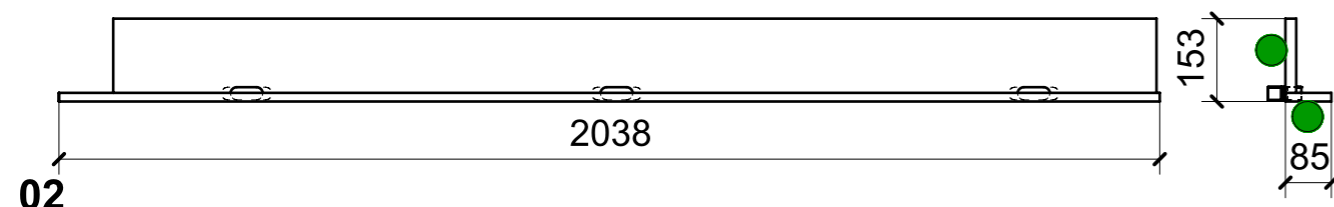
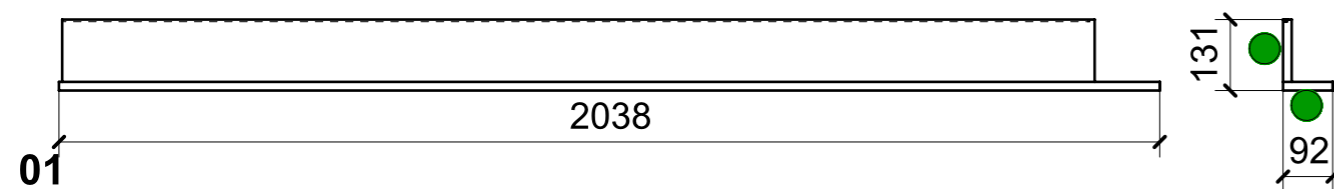

05

06

07

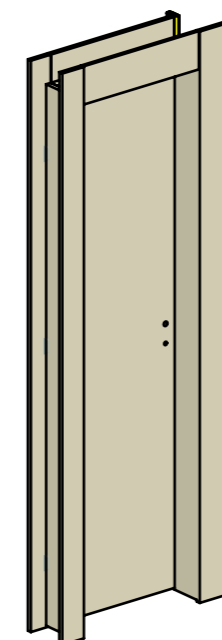
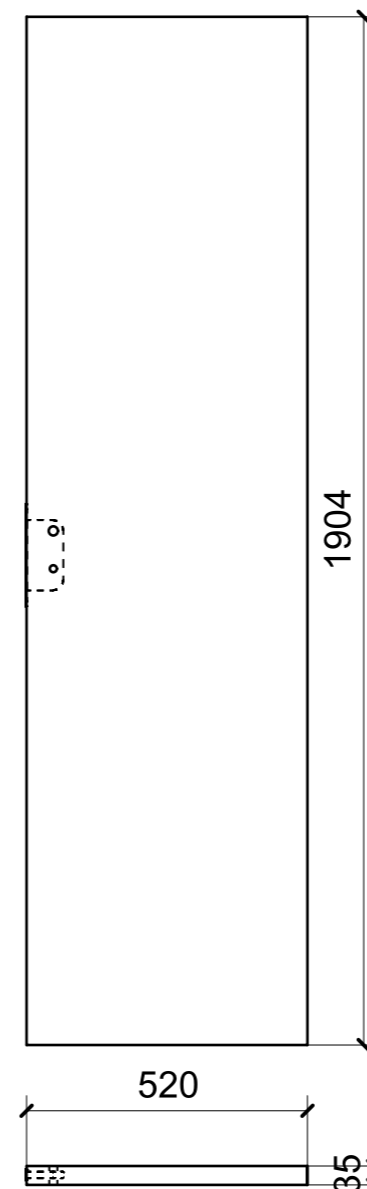

ELEMENTI DA MONTARE IN MG\_P1  
e spedire con unico imballo

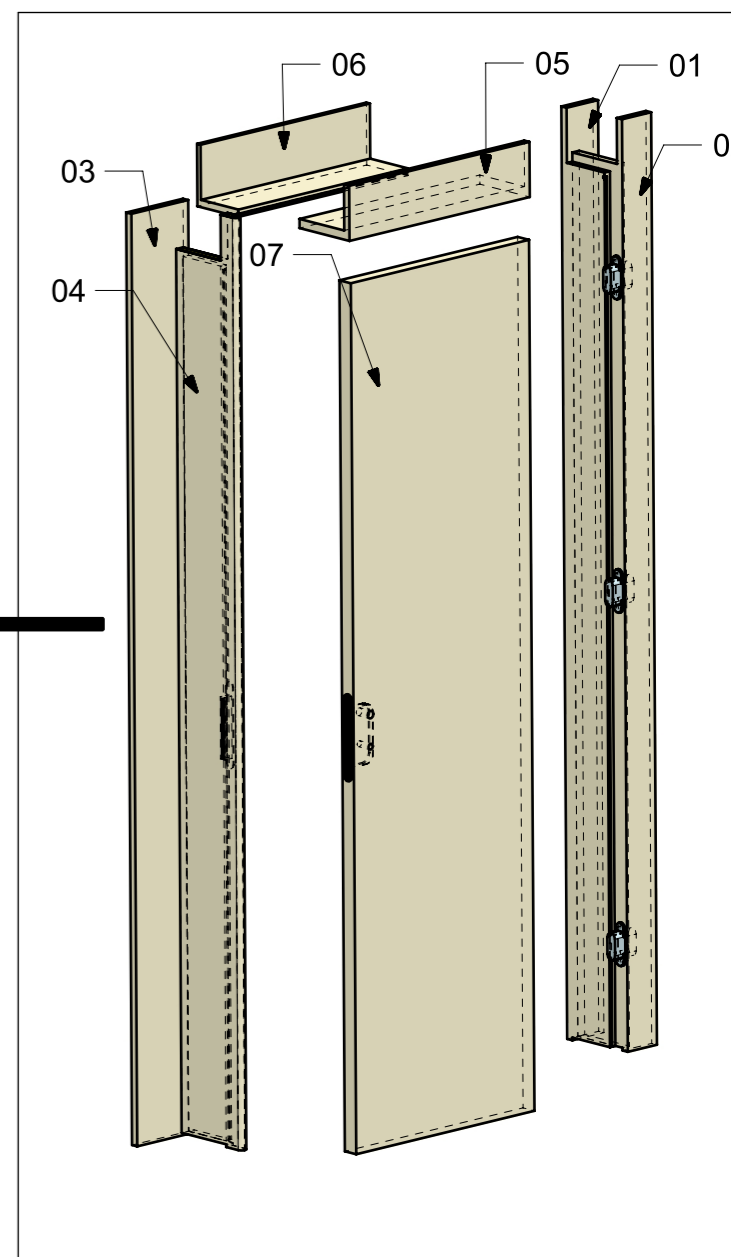

| FERRAMENTA  | QTY |
|---|-----|
| GUARNIZIONE X PORTE MARRONE_FBC_ART_A106K                       | 1   |
| CERNIERA INVISIBILE KOBLENZ_FBC_COD K6200 20 CL                 | 3   |
| CONTROPIASTRA MAGNETICA CROMO LUCIDO 992 CR L_FBC               | 1   |
| SERRATURA MAGNETICA B-ONE CROMATO LUCIDO 901 (INTERASSE 70)_FBC | 1   |

VERNICIATURA LASTRA/LACCATI:

● = VERNICIARE 1 LATO + FILI RASATI O BORDATI

NESSUN SIMBOLO = VERNICIARE 2 LATI + FILI RASATI O BORDATI

| LOCALE | CODICE       | DESCRIZIONE COMPONENTE | FINITURA | Q.TA |
|--------|--------------|------------------------|----------|------|
| PORTE  | MD299_A01_P1 | PORTA CAB ARMATORE     | ACCIAIO  | 1    |

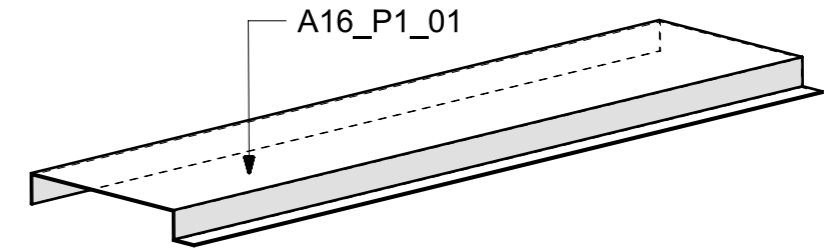
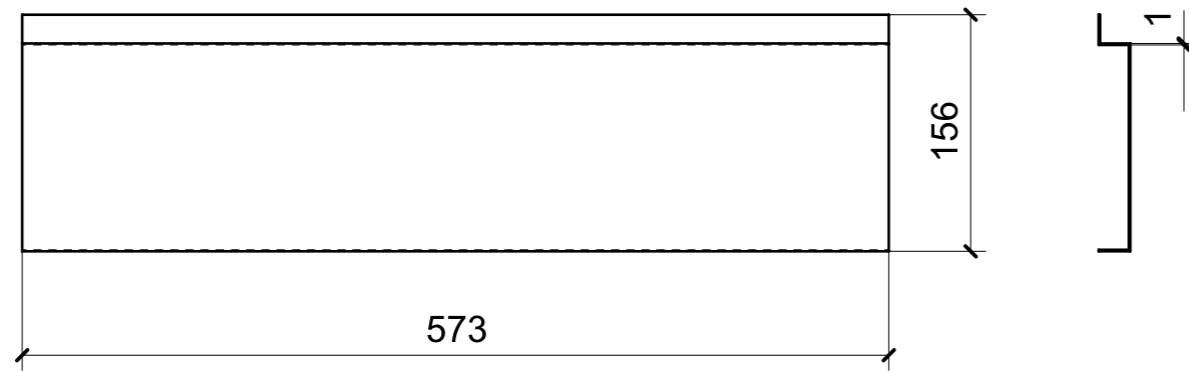

A16\_P1\_01

| LOCALE | CODICE      | DESCRIZIONE COMPONENTE | FINITURA     | Q.TA |
|--------|-------------|------------------------|--------------|------|
| PORTE  | MD299_MG_P2 | PORTA BAGNO ARMATORE   | LASTRA SCURA | 1    |

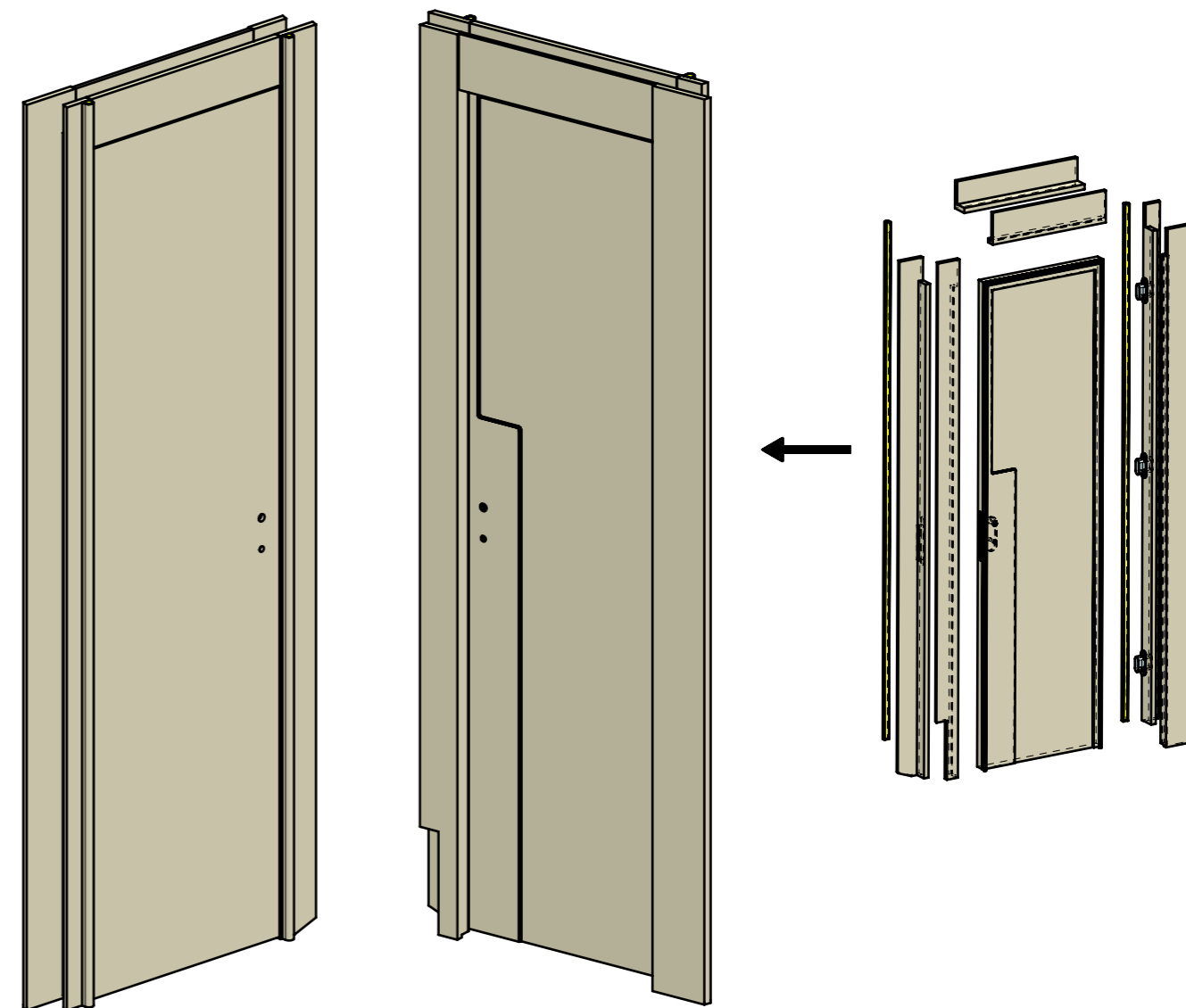
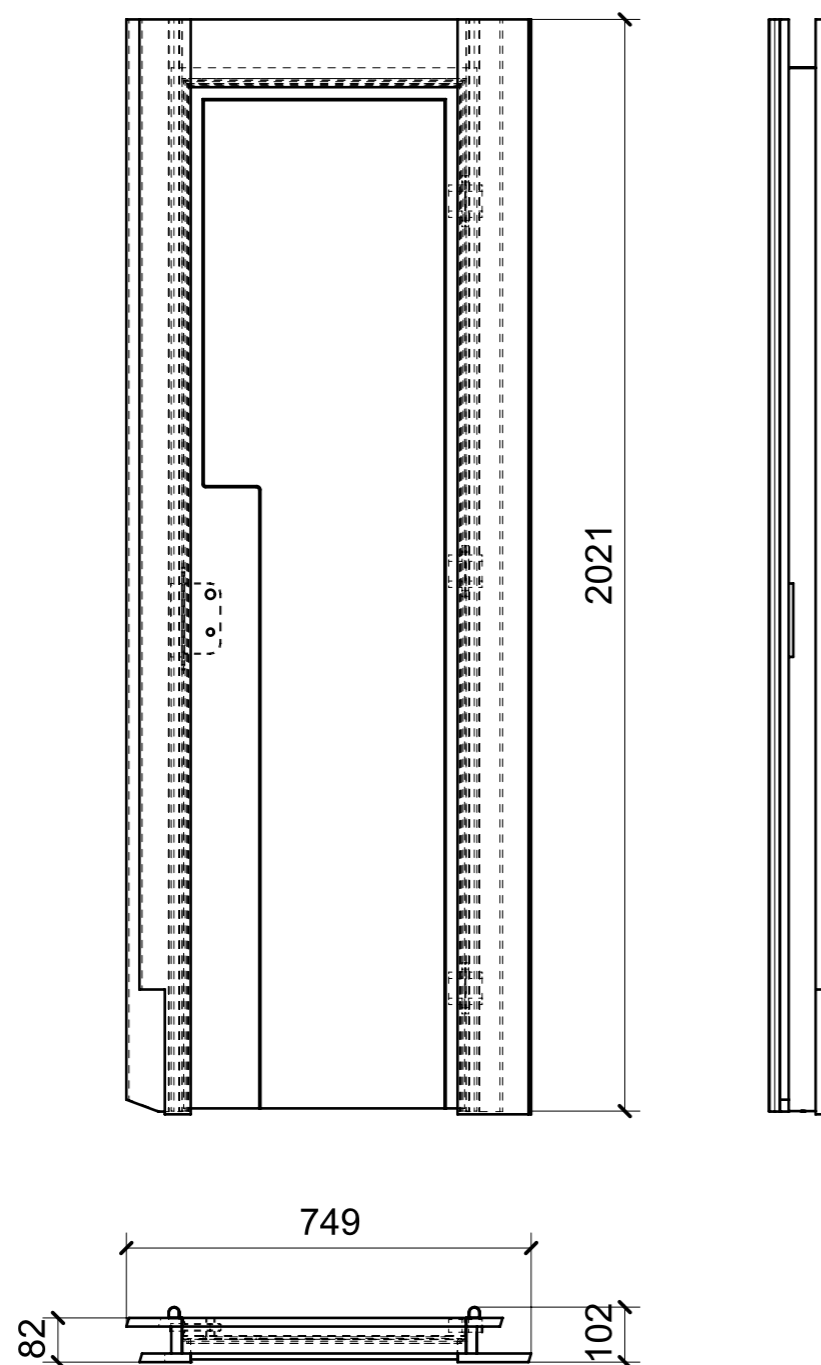

| FERRAMENTA  | QTY |
|---|-----|
| GUARNIZIONE X PORTE MARRONE_FBC_ART_A106K                       | 1   |
| CERNIERA INVISIBILE KOBLENZ_FBC_COD K6200 20 CL                 | 3   |
| CONTROPIASTRA MAGNETICA CROMO LUCIDO 992 CR L_FBC               | 1   |
| SERRATURA MAGNETICA B-ONE CROMATO LUCIDO 901 (INTERASSE 70)_FBC | 1   |

| LOCALE | CODICE       | DESCRIZIONE COMPONENTE | FINITURA     | Q.TA |
|--------|--------------|------------------------|--------------|------|
| PORTE  | MD299_R01_P2 | PORTA BAGNO ARMATORE   | LASTRA SCURA | 1    |

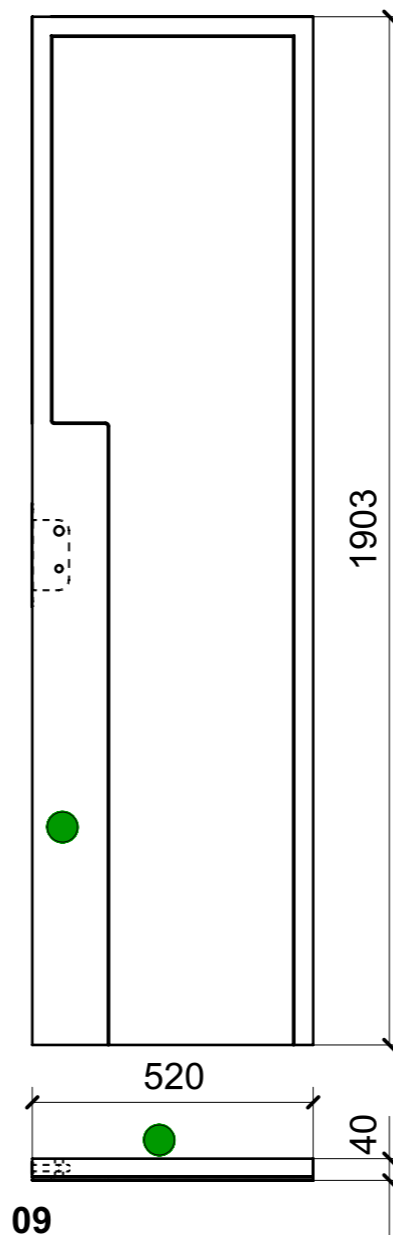
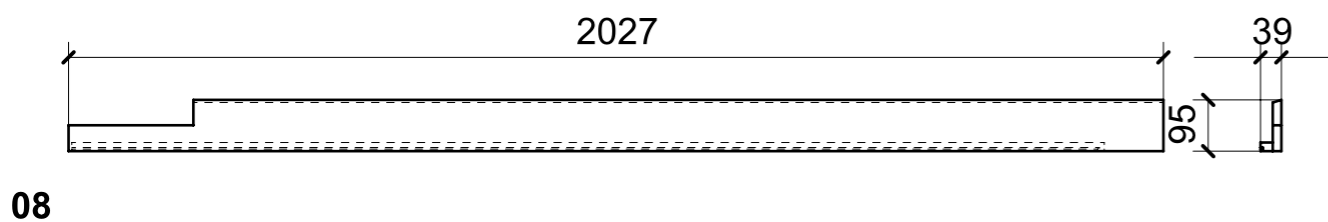
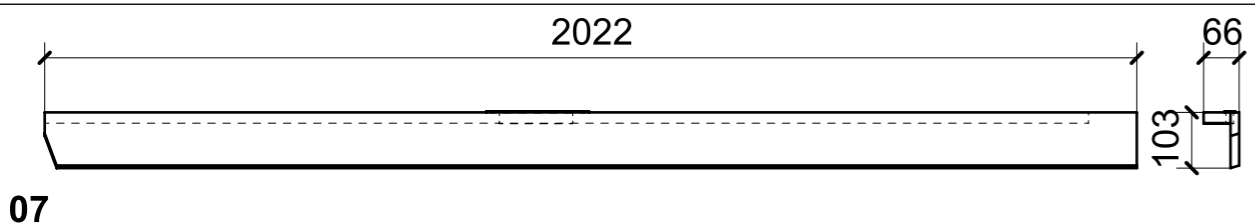
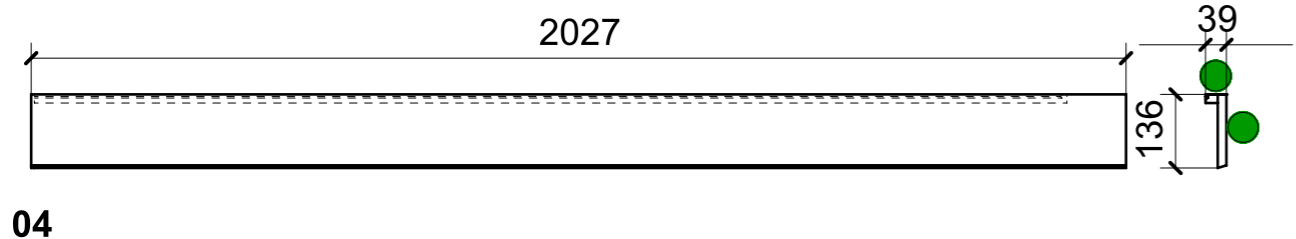
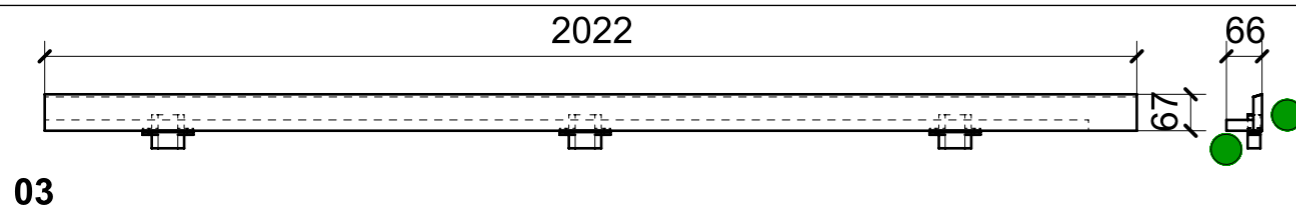
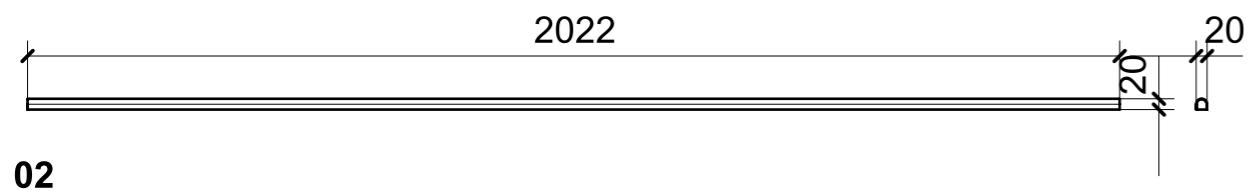
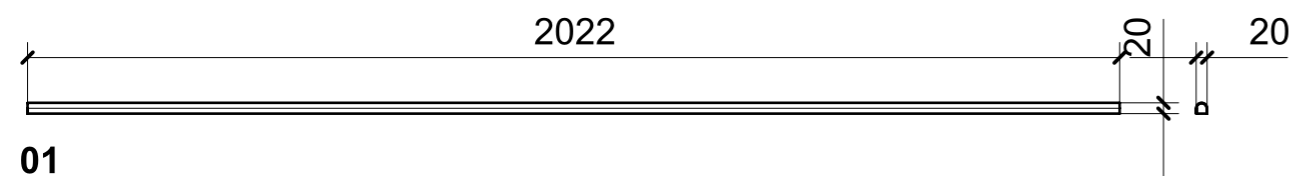

ELEMENTI DA MONTARE IN MG\_P2  
e spedire con unico imballo

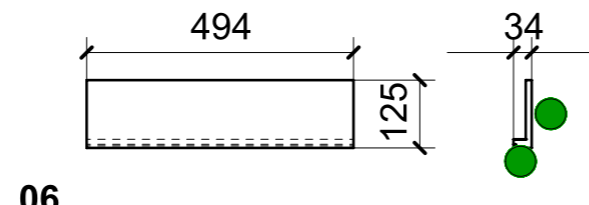
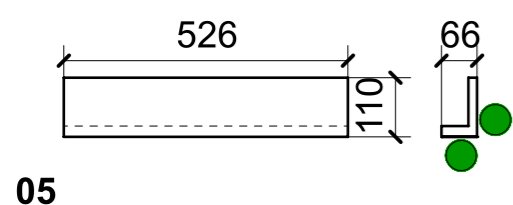
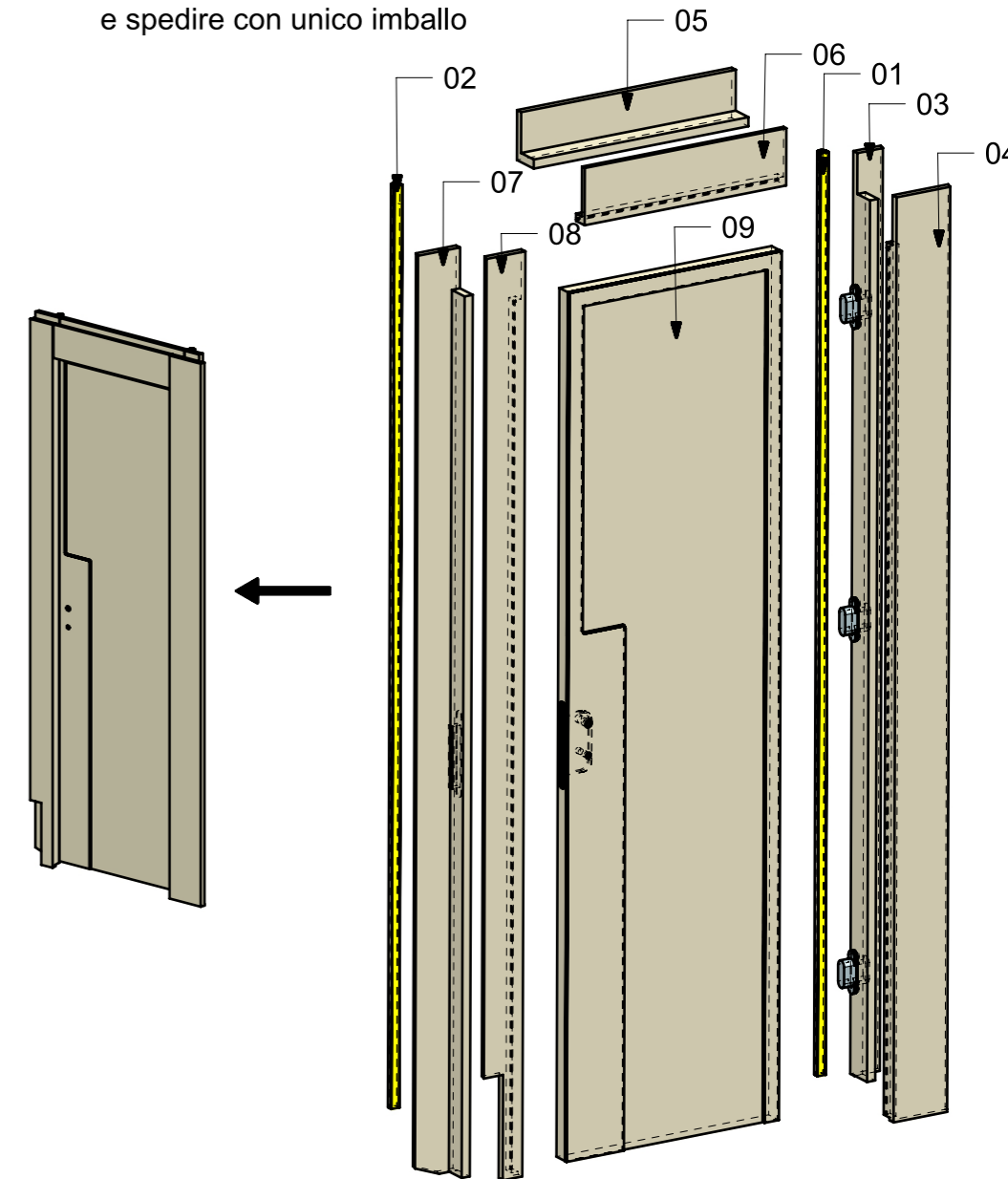

| FERRAMENTA  | QTY |
|---|-----|
| GUARNIZIONE X PORTE MARRONE_FBC_ART_A106K                       | 1   |
| CERNIERA INVISIBILE KOBLENZ_FBC_COD K6200 20 CL                 | 3   |
| CONTROPIASTRA MAGNETICA CROMO LUCIDO 992 CR L_FBC               | 1   |
| SERRATURA MAGNETICA B-ONE CROMATO LUCIDO 901 (INTERASSE 70)_FBC | 1   |

VERNICIATURA LASTRA/LACCATI:

● = VERNICIARE 1 LATO + FILI RASATI O BORDATI

NESSUN SIMBOLO = VERNICIARE 2 LATI + FILI RASATI O BORDATI

| LOCALE | CODICE       | DESCRIZIONE COMPONENTE | FINITURA | Q.TA |
|--------|--------------|------------------------|----------|------|
| PORTE  | MD299_A01_P2 | PORTA BAGNO ARMATORE   | ACCIAIO  | 1    |

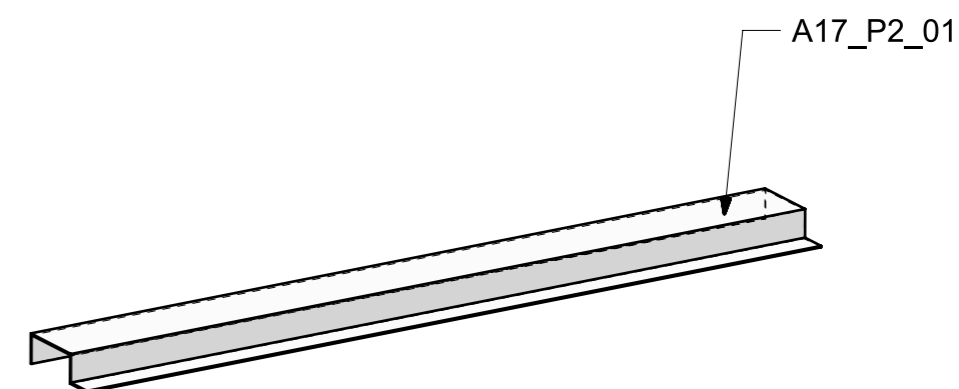
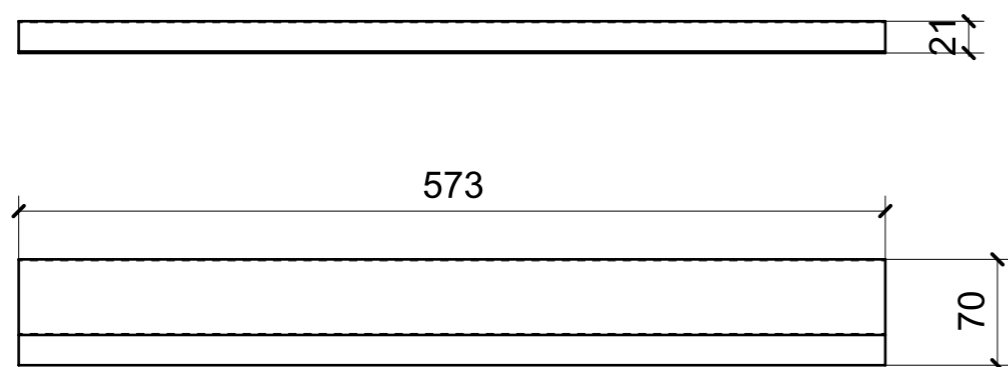

A17\_P2\_01

| LOCALE | CODICE      | DESCRIZIONE COMPONENTE       | FINITURA     | Q.TA |
|--------|-------------|------------------------------|--------------|------|
| PORTE  | MD299_MG_P3 | PORTA BAGNO CABINA OSPITI SX | LASTRA SCURA | 1    |

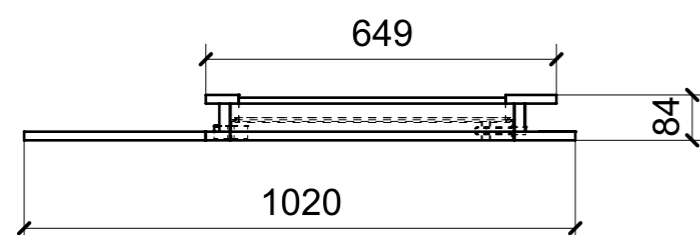
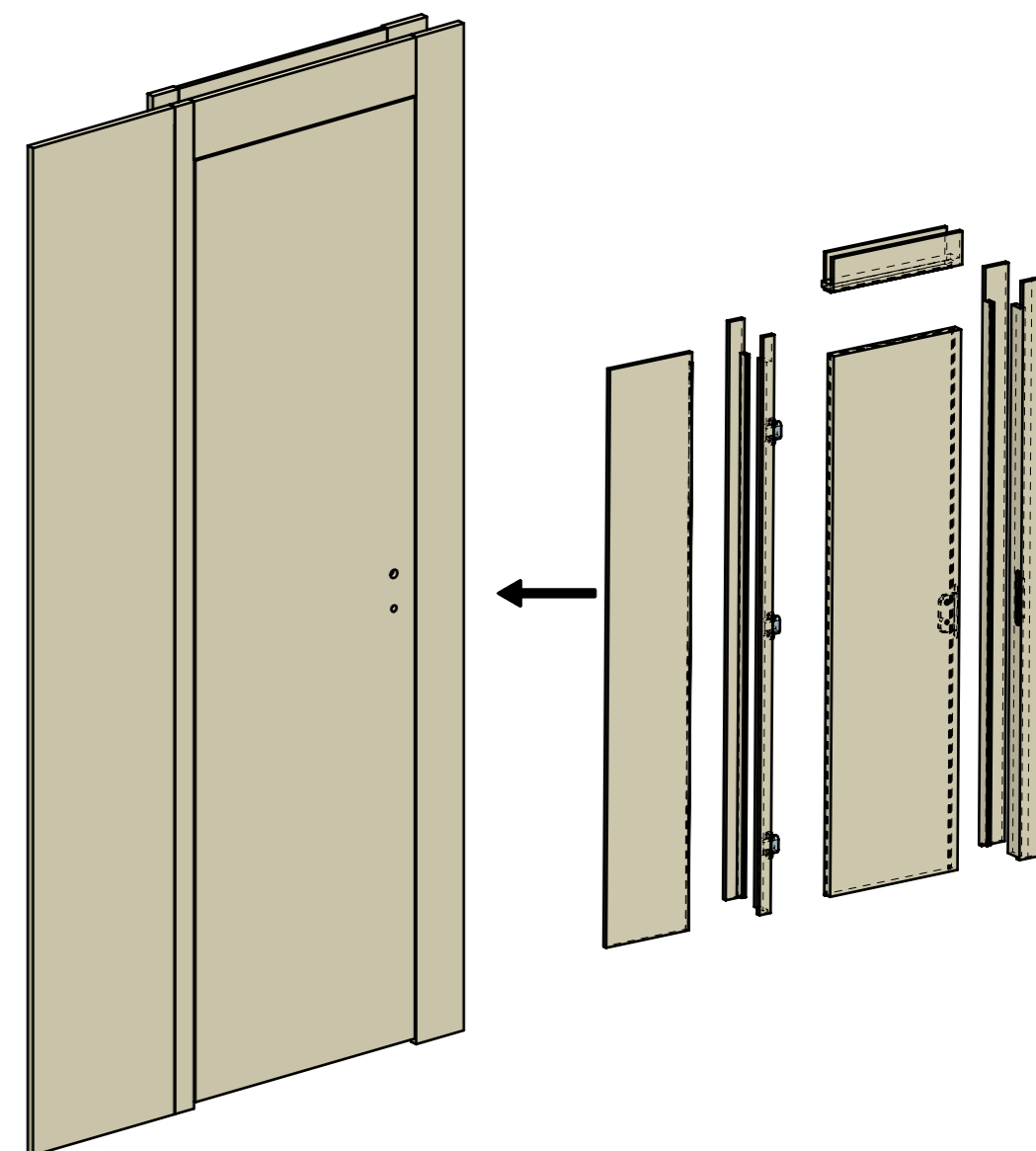
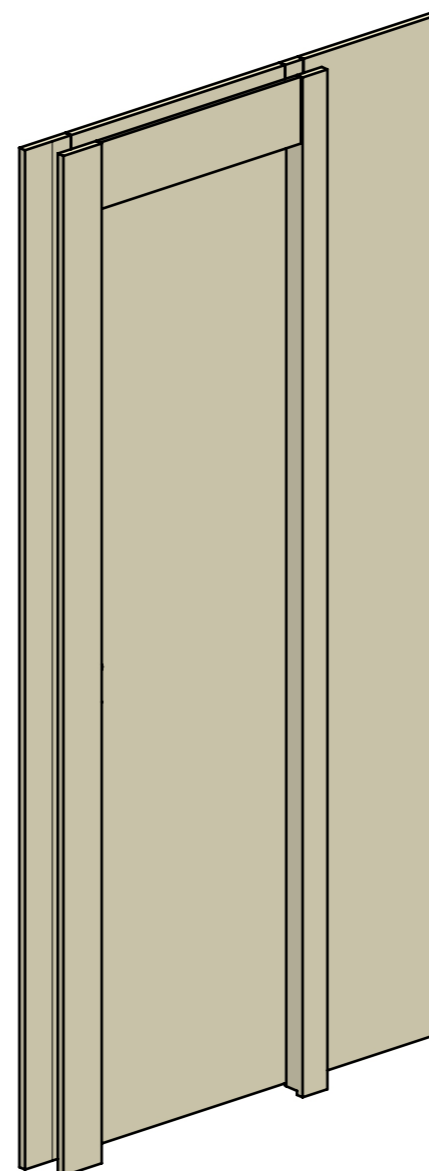
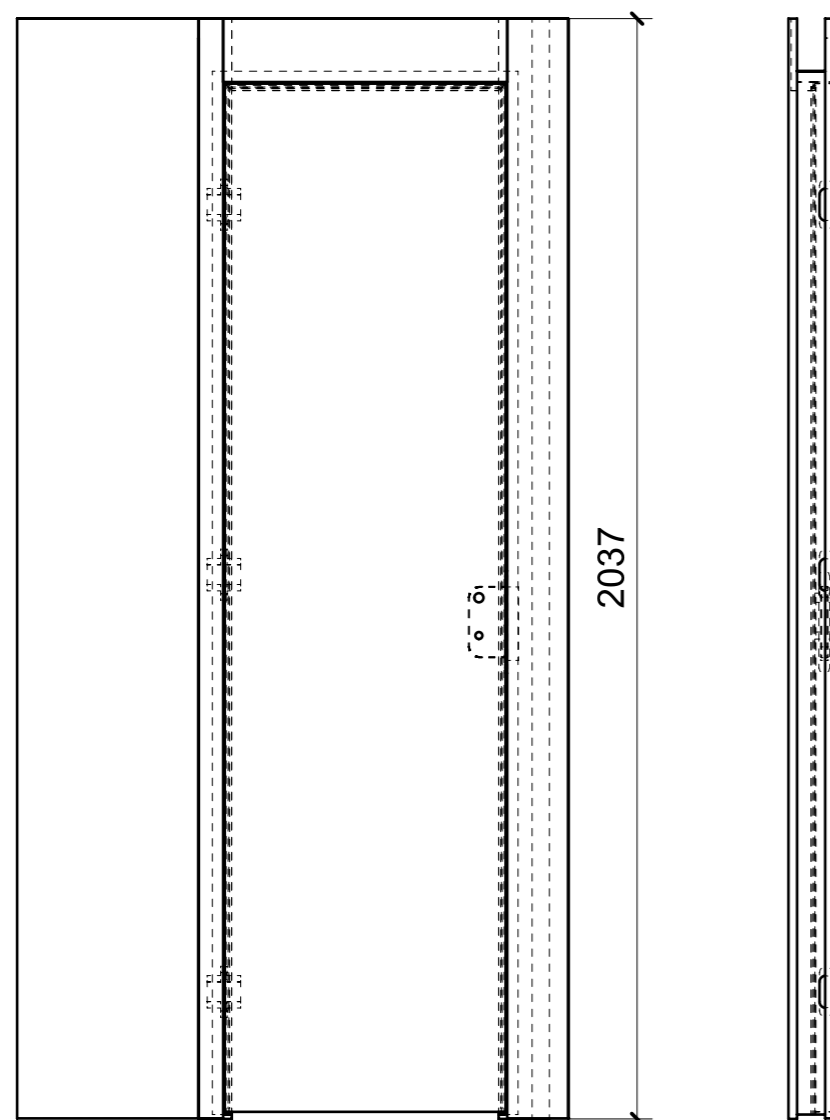

| FERRAMENTA  | QTY |
|---|-----|
| GUARNIZIONE X PORTE MARRONE_FBC_ART_A106K                       | 1   |
| CERNIERA INVISIBILE KOBLENZ_FBC_COD K6200 20 CL                 | 3   |
| CONTROPIASTRA MAGNETICA CROMO LUCIDO 992 CR L_FBC               | 1   |
| SERRATURA MAGNETICA B-ONE CROMATO LUCIDO 901 (INTERASSE 70)_FBC | 1   |

| LOCALE | CODICE       | DESCRIZIONE COMPONENTE       | FINITURA     | Q.TA |
|--------|--------------|------------------------------|--------------|------|
| PORTE  | MD299_R01_P3 | PORTA BAGNO CABINA OSPITI SX | LASTRA SCURA | 1    |

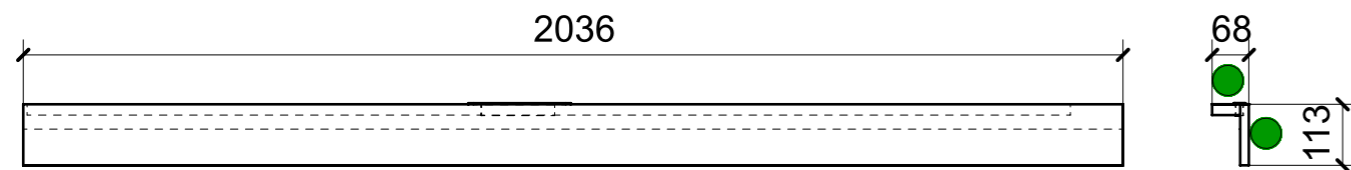

01

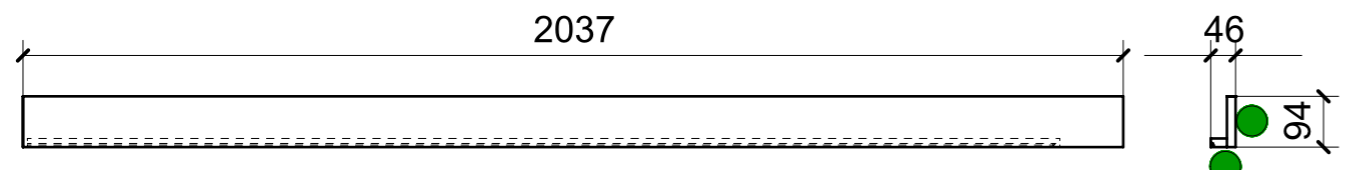

02

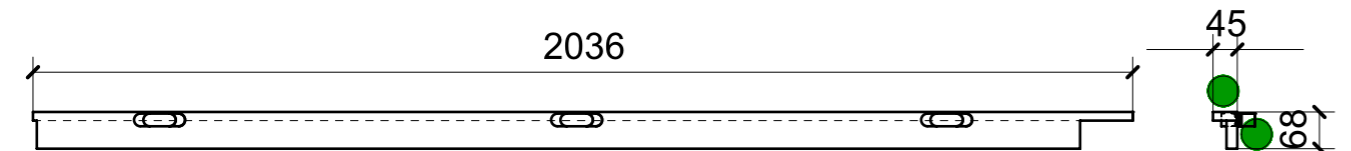

05

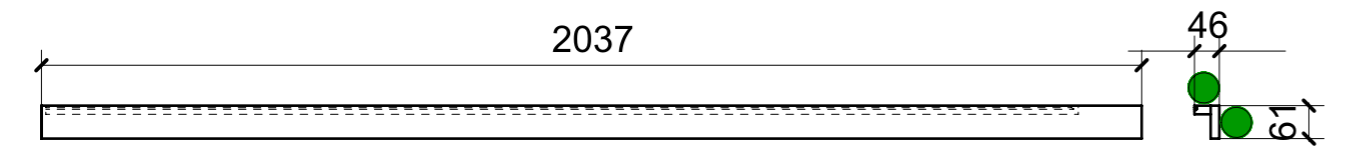

06

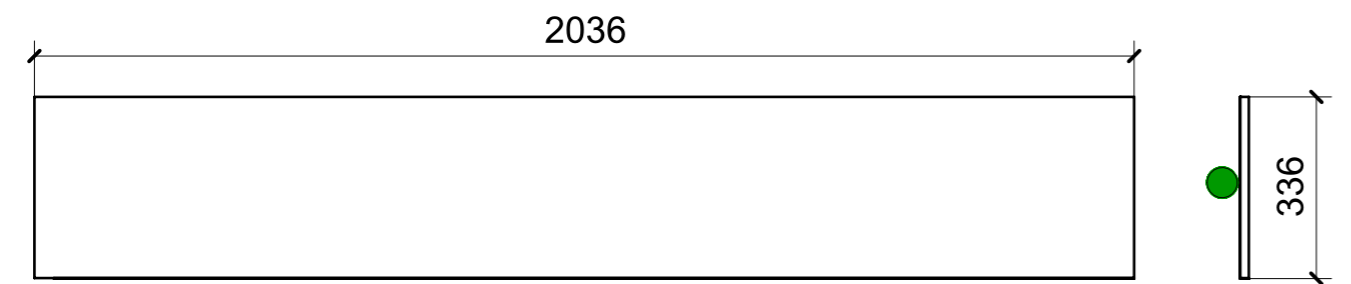

08

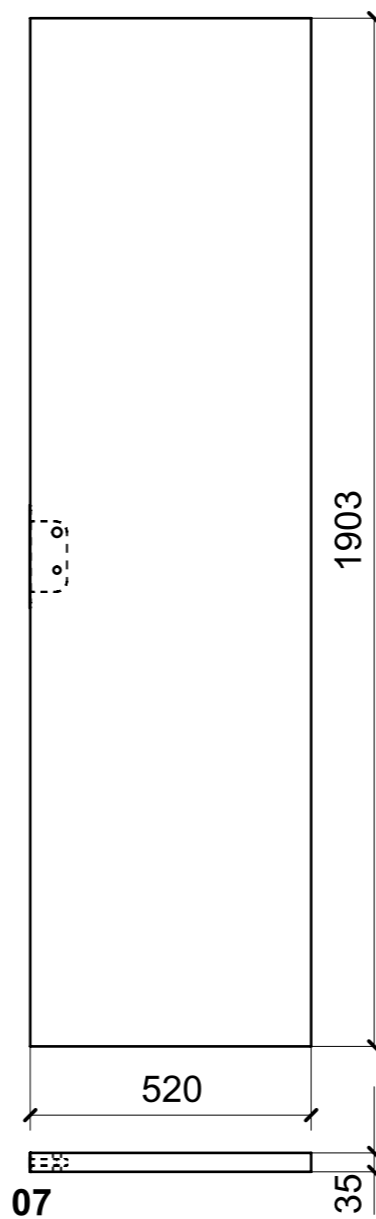

07

35

ELEMENTI DA MONTARE IN MG\_P3  
e spedire con unico imballo

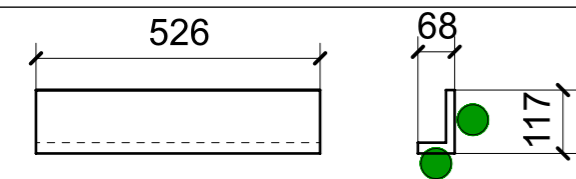
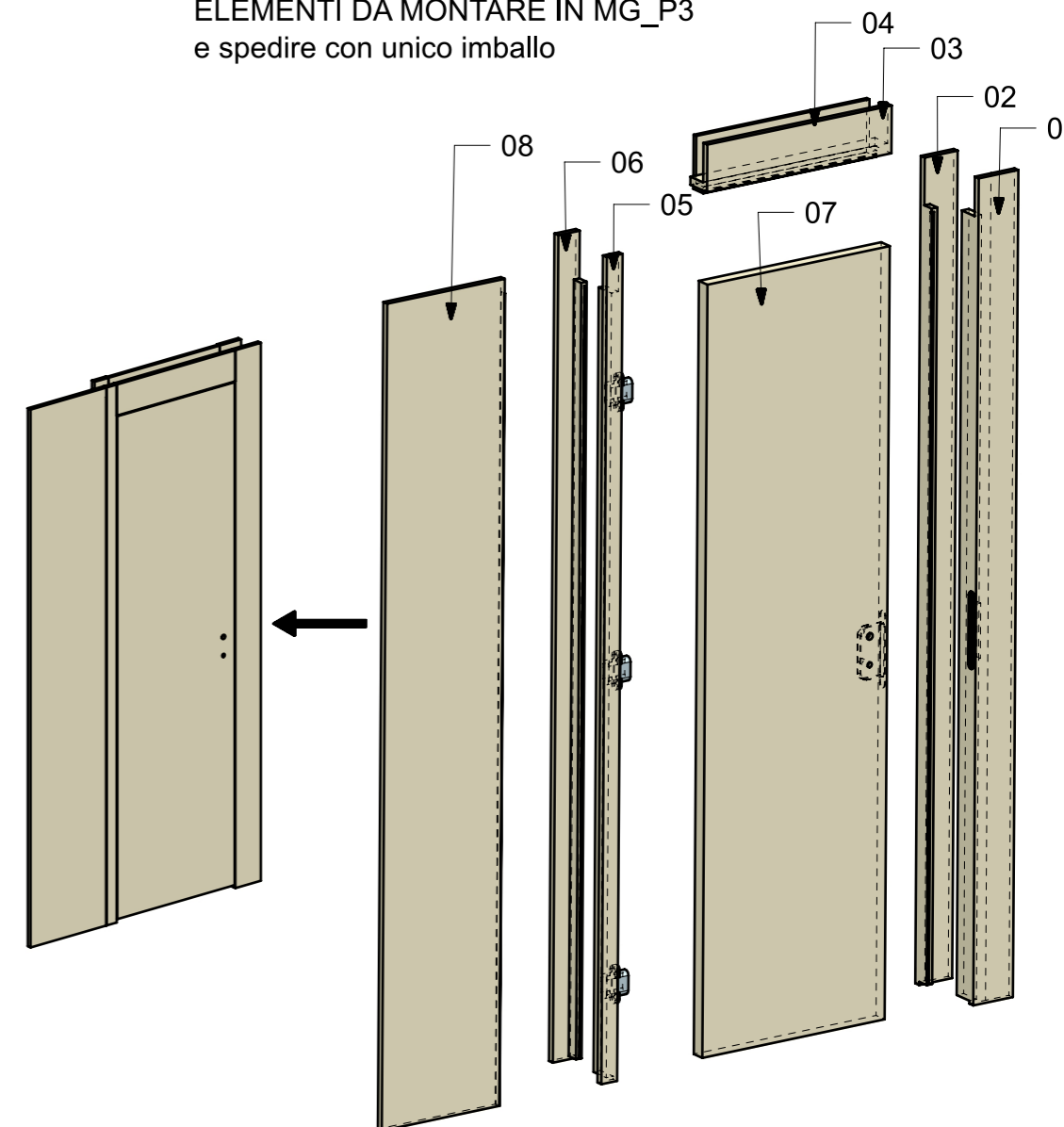

03

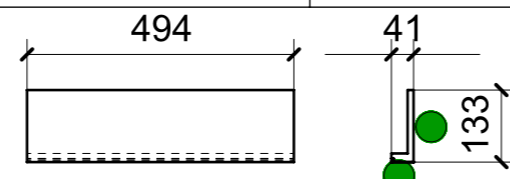

04

| FERRAMENTA  | QTY |
|---|-----|
| GUARNIZIONE X PORTE MARRONE_FBC_ART_A106K                       | 1   |
| CERNIERA INVISIBILE KOBLENZ_FBC_COD K6200 20 CL                 | 3   |
| CONTROPIASTRA MAGNETICA CROMO LUCIDO 992 CR L_FBC               | 1   |
| SERRATURA MAGNETICA B-ONE CROMATO LUCIDO 901 (INTERASSE 70)_FBC | 1   |

VERNICIATURA LASTRA/LACCATI:

● = VERNICIARE 1 LATO + FILI RASATI O BORDATI

NESSUN SIMBOLO = VERNICIARE 2 LATI + FILI RASATI O BORDATI

| LOCALE | CODICE       | DESCRIZIONE COMPONENTE       | FINITURA | Q.TA |
|--------|--------------|------------------------------|----------|------|
| PORTE  | MD299_A01_P3 | PORTA BAGNO CABINA OSPITI SX | ACCIAIO  | 1    |

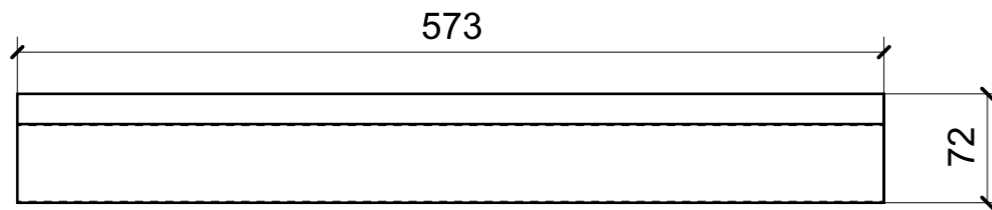
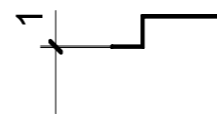
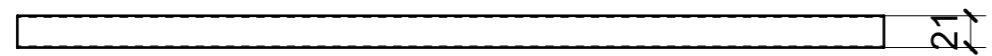

A18\_P3\_01

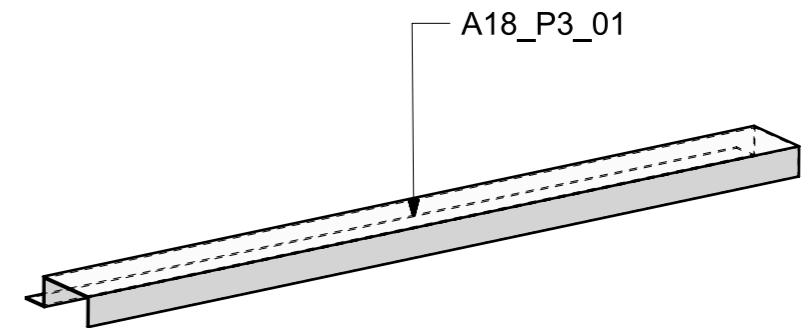

| LOCALE | CODICE      | DESCRIZIONE COMPONENTE | FINITURA     | Q.TA |
|--------|-------------|------------------------|--------------|------|
| PORTE  | MD299_MG_P4 | PORTA CABINA OSPITI SX | LASTRA SCURA | 1    |

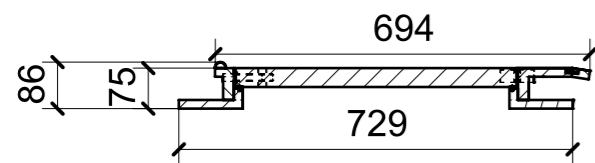
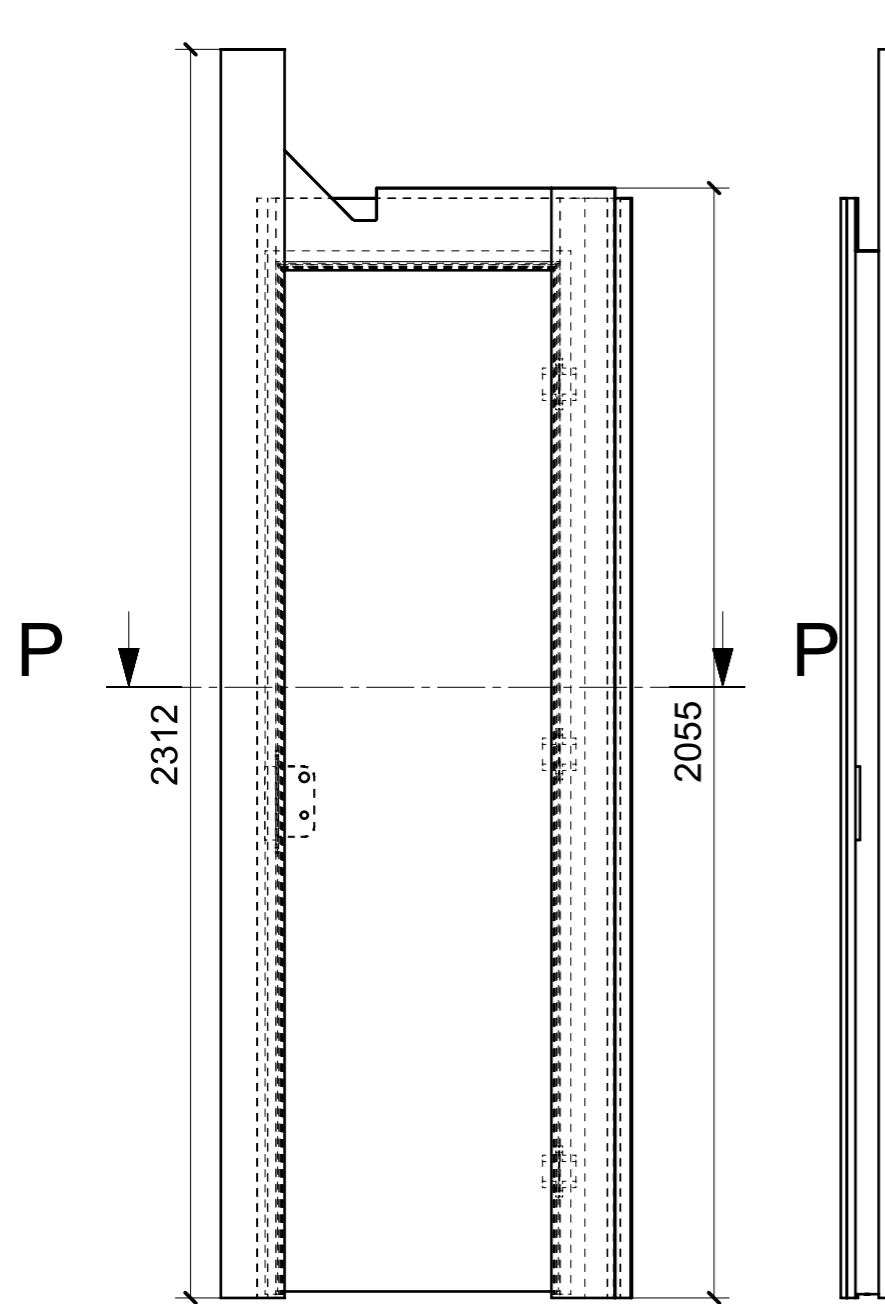

SECTION P-P

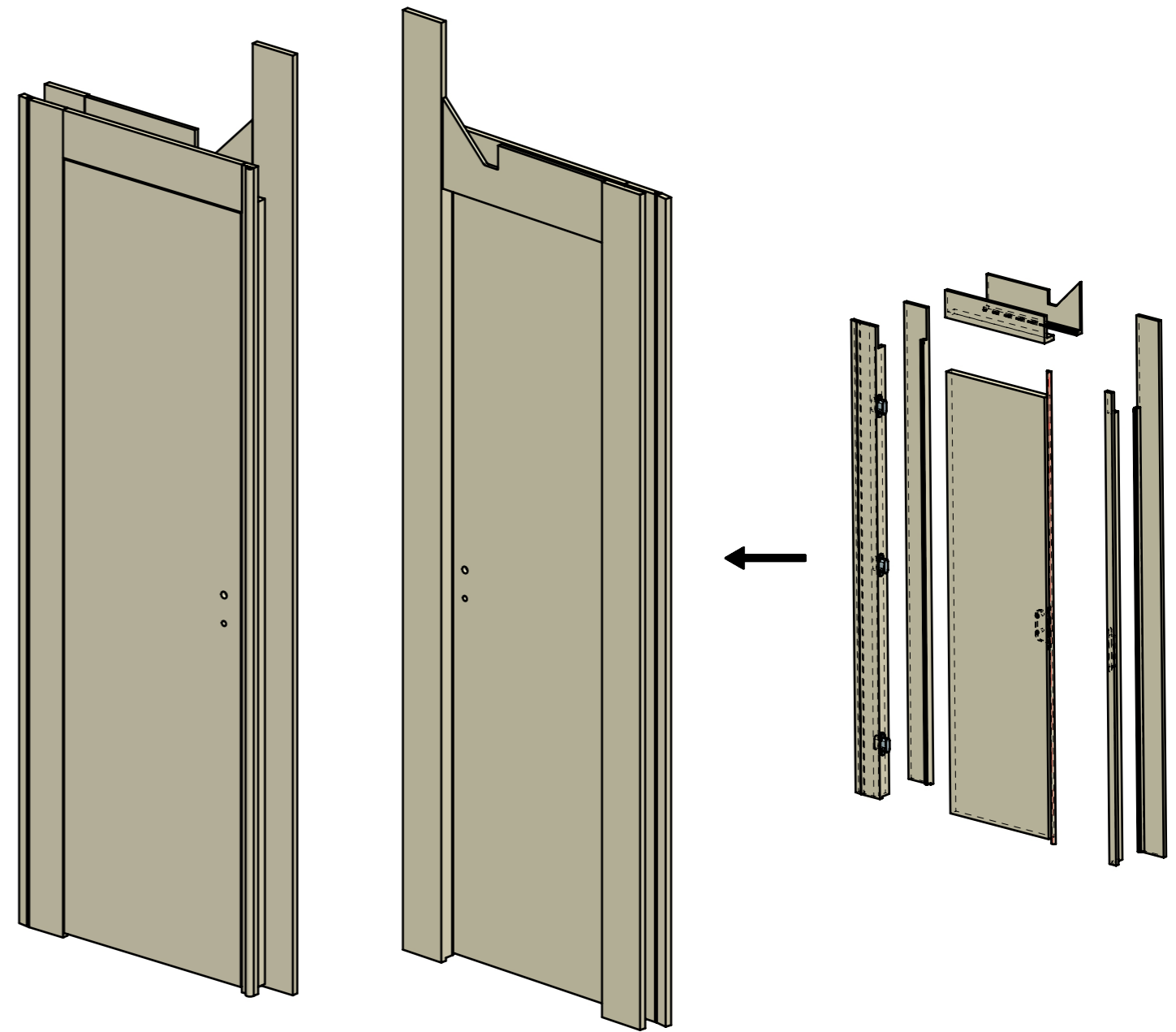

| FERRAMENTA  | QTY |
|---|-----|
| GUARNIZIONE X PORTE MARRONE_FBC_ART_A106K                       | 1   |
| CERNIERA INVISIBILE KOBLENZ_FBC_COD K6200 20 CL                 | 3   |
| CONTROPIASTRA MAGNETICA CROMO LUCIDO 992 CR L_FBC               | 1   |
| SERRATURA MAGNETICA B-ONE CROMATO LUCIDO 901 (INTERASSE 70)_FBC | 1   |

VERNICIATURA LASTRA/LACCATI:

● = VERNICIARE 1 LATO + FILI RASATI O BORDATI

NESSUN SIMBOLO = VERNICIARE 2 LATI + FILI RASATI O BORDATI

| LOCALE | CODICE       | DESCRIZIONE COMPONENTE | FINITURA     | Q.TA |
|--------|--------------|------------------------|--------------|------|
| PORTE  | MD299_R01_P4 | PORTA CABINA OSPITI SX | LASTRA SCURA | 1    |

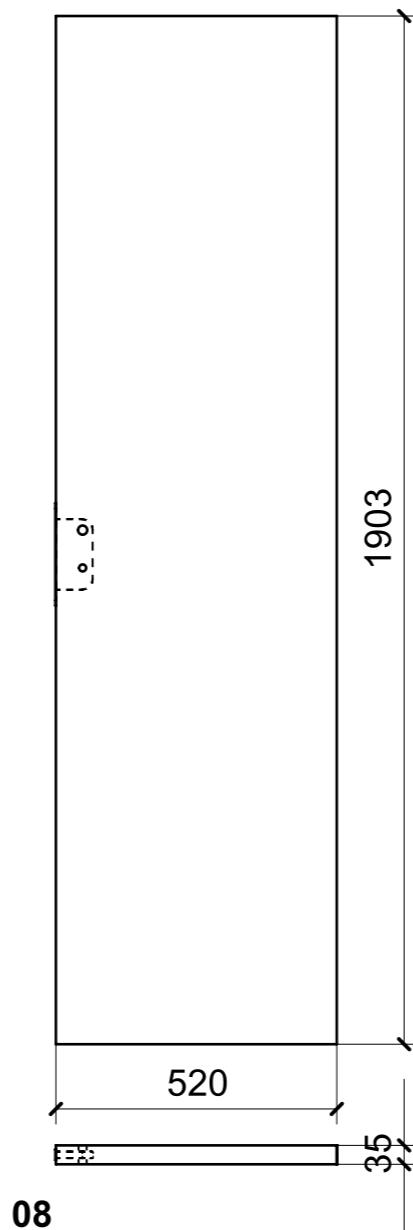
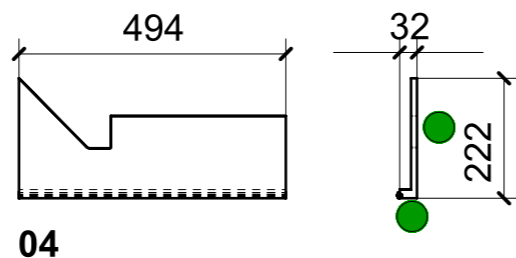
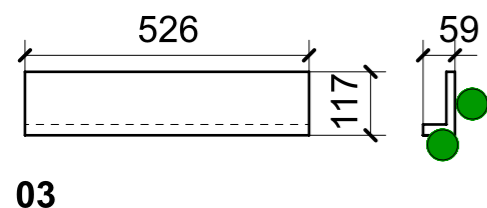
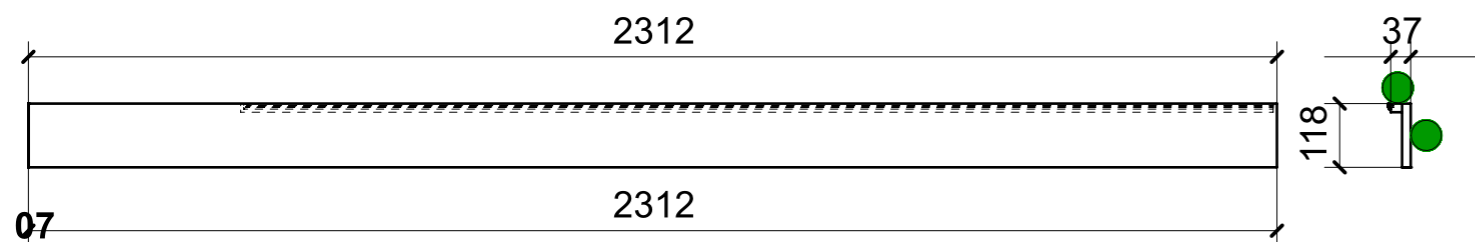
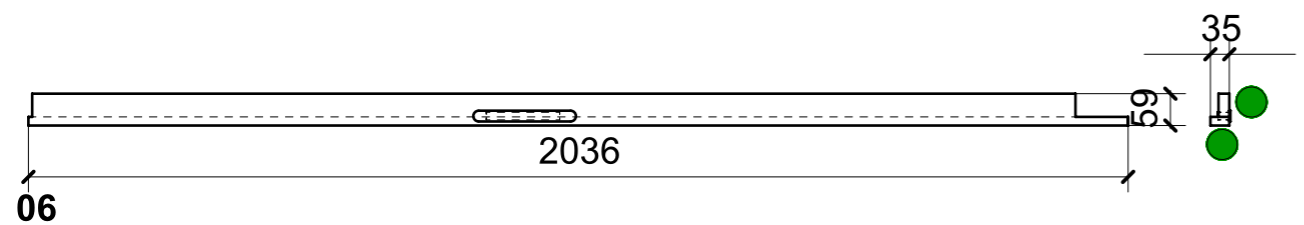
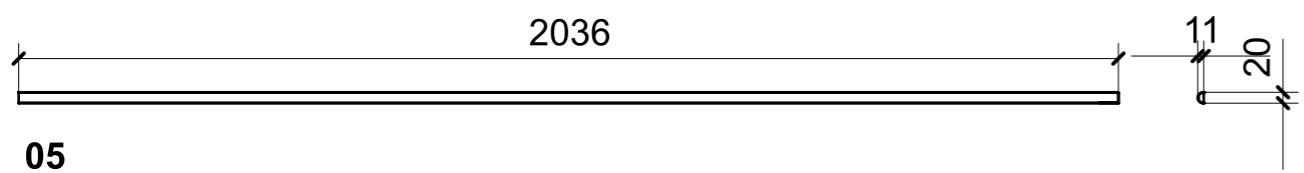
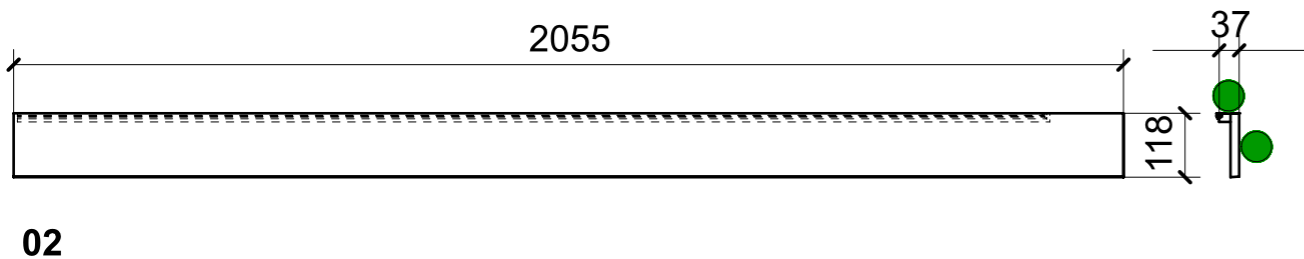
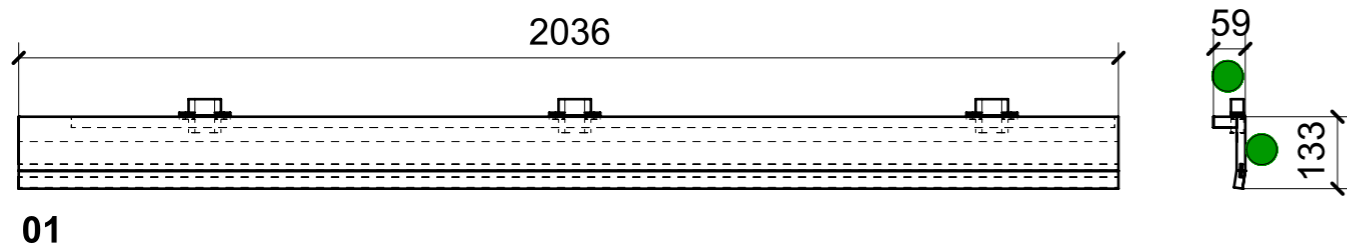

ELEMENTI DA MONTARE IN MG\_P4  
e spedire con unico imballo

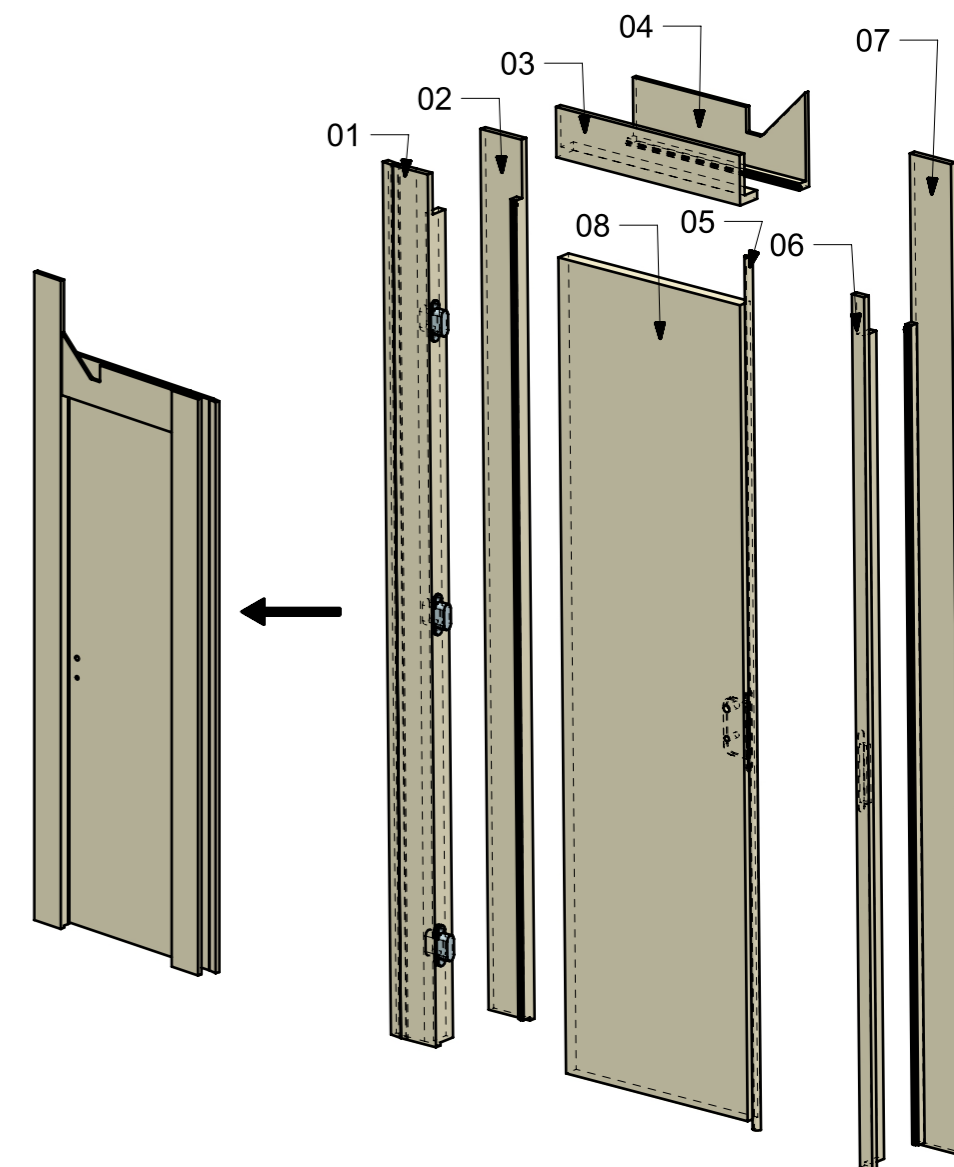

| FERRAMENTA  | QTY |
|---|-----|
| GUARNIZIONE X PORTE MARRONE_FBC_ART_A106K                       | 1   |
| CERNIERA INVISIBILE KOBLENZ_FBC_COD K6200 20 CL                 | 3   |
| CONTROPIASTRA MAGNETICA CROMO LUCIDO 992 CR L_FBC               | 1   |
| SERRATURA MAGNETICA B-ONE CROMATO LUCIDO 901 (INTERASSE 70)_FBC | 1   |

VERNICIATURA LASTRA/LACCATI:

● = VERNICIARE 1 LATO + FILI RASATI O BORDATI

NESSUN SIMBOLO = VERNICIARE 2 LATI + FILI RASATI O BORDATI

| LOCALE | CODICE       | DESCRIZIONE COMPONENTE | FINITURA | Q.TA |
|--------|--------------|------------------------|----------|------|
| PORTE  | MD299_A01_P4 | PORTA CABINA OSPITI SX | ACCIAIO  | 1    |

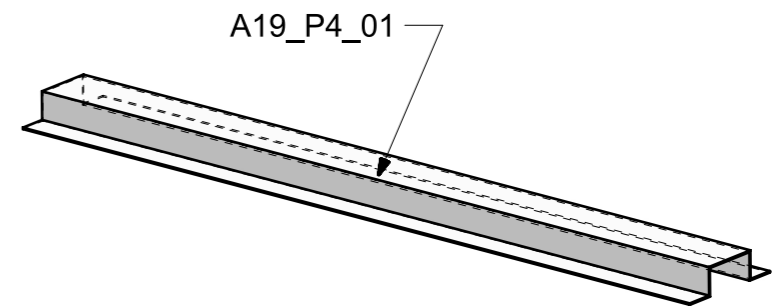
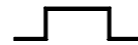
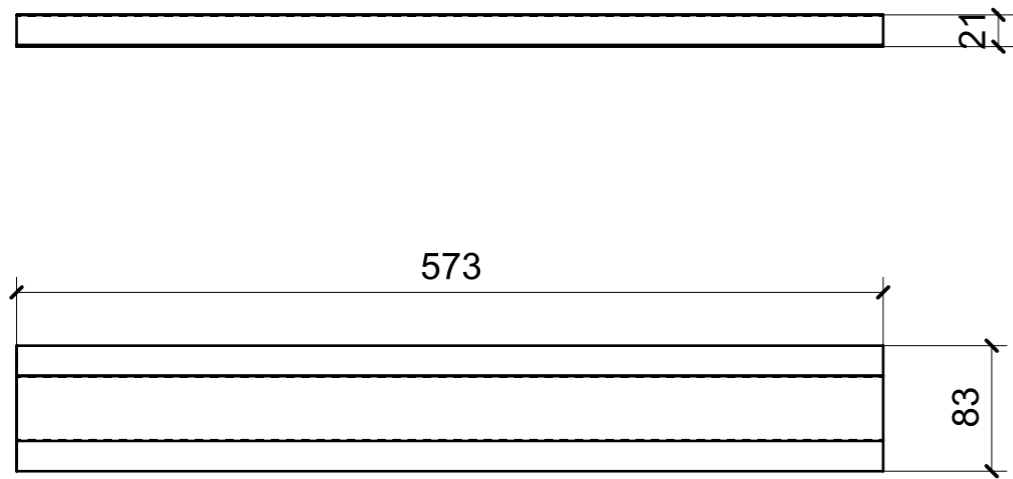

A19\_P4\_01

| LOCALE | CODICE      | DESCRIZIONE COMPONENTE             | FINITURA     | Q.TA |
|--------|-------------|------------------------------------|--------------|------|
| PORTE  | MD299_MG_P5 | PORTA BAGNO OSPITI SX DA CORRIDOIO | LASTRA SCURA | 1    |

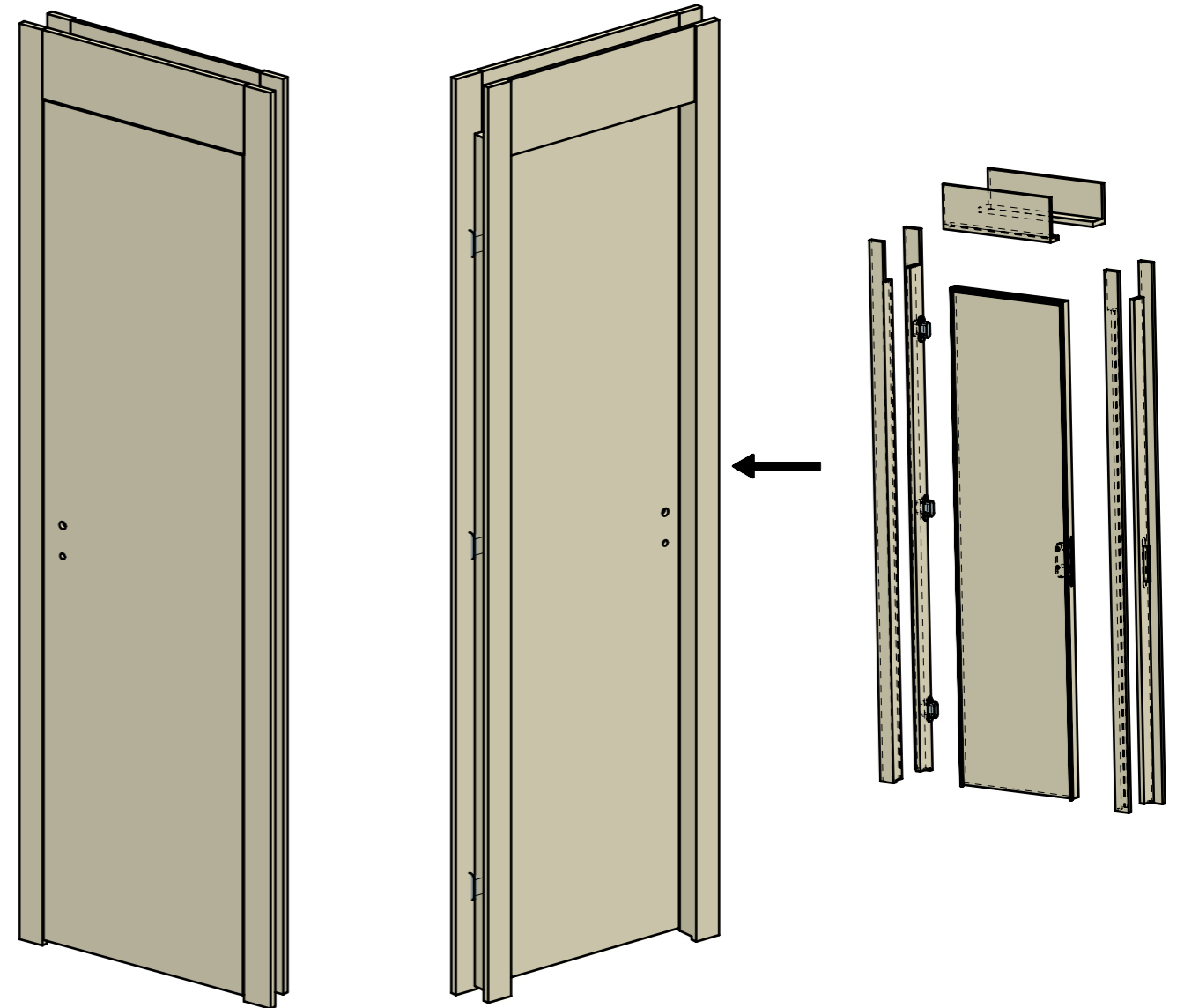
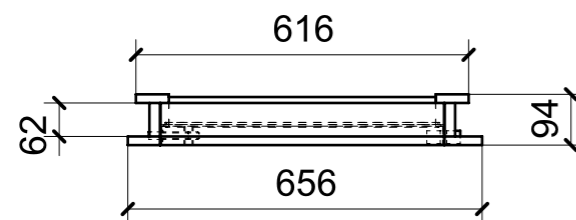
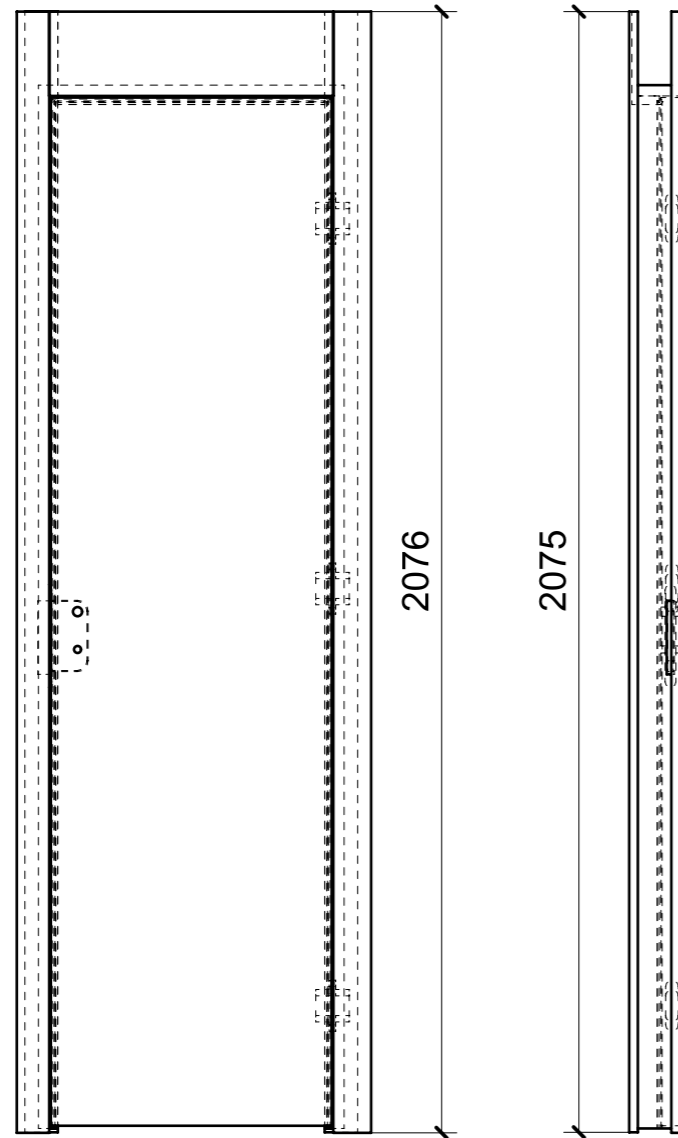

| FERRAMENTA  | QTY |
|---|-----|
| GUARNIZIONE X PORTE MARRONE_FBC_ART_A106K                       | 1   |
| CERNIERA INVISIBILE KOBLENZ_FBC_COD K6200 20 CL                 | 3   |
| CONTROPIASTRA MAGNETICA CROMO LUCIDO 992 CR L_FBC               | 1   |
| SERRATURA MAGNETICA B-ONE CROMATO LUCIDO 901 (INTERASSE 70)_FBC | 1   |

| LOCALE | CODICE       | DESCRIZIONE COMPONENTE             | FINITURA     | Q.TA |
|--------|--------------|------------------------------------|--------------|------|
| PORTE  | MD299_R01_P5 | PORTA BAGNO OSPITI SX DA CORRIDOIO | LASTRA SCURA | 1    |

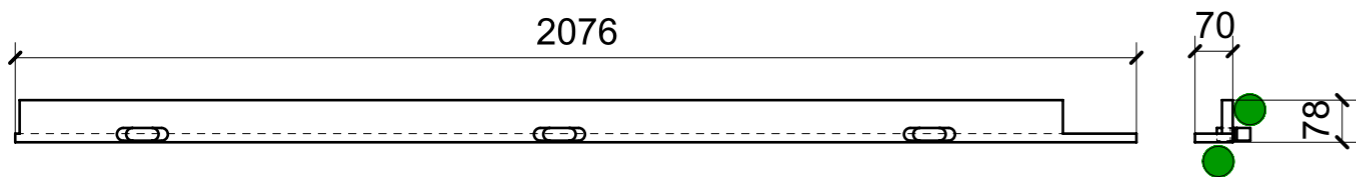

01

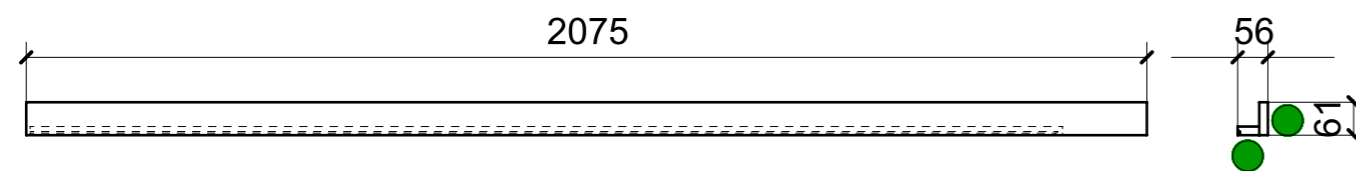

02



05

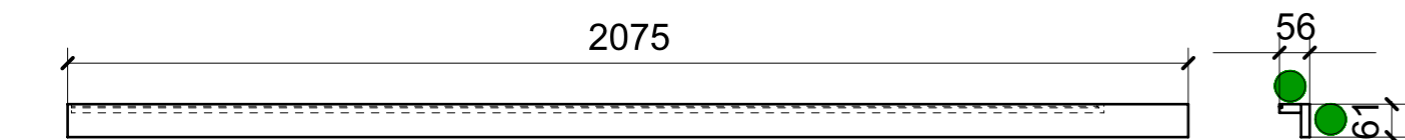

06

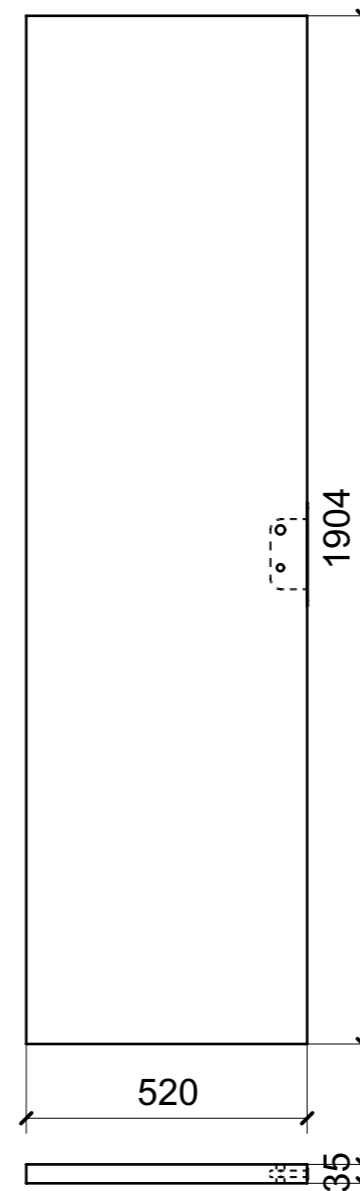

07

ELEMENTI DA MONTARE IN MG\_P5  
e spedire con unico imballo

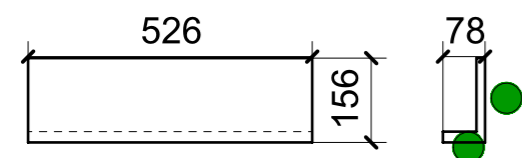
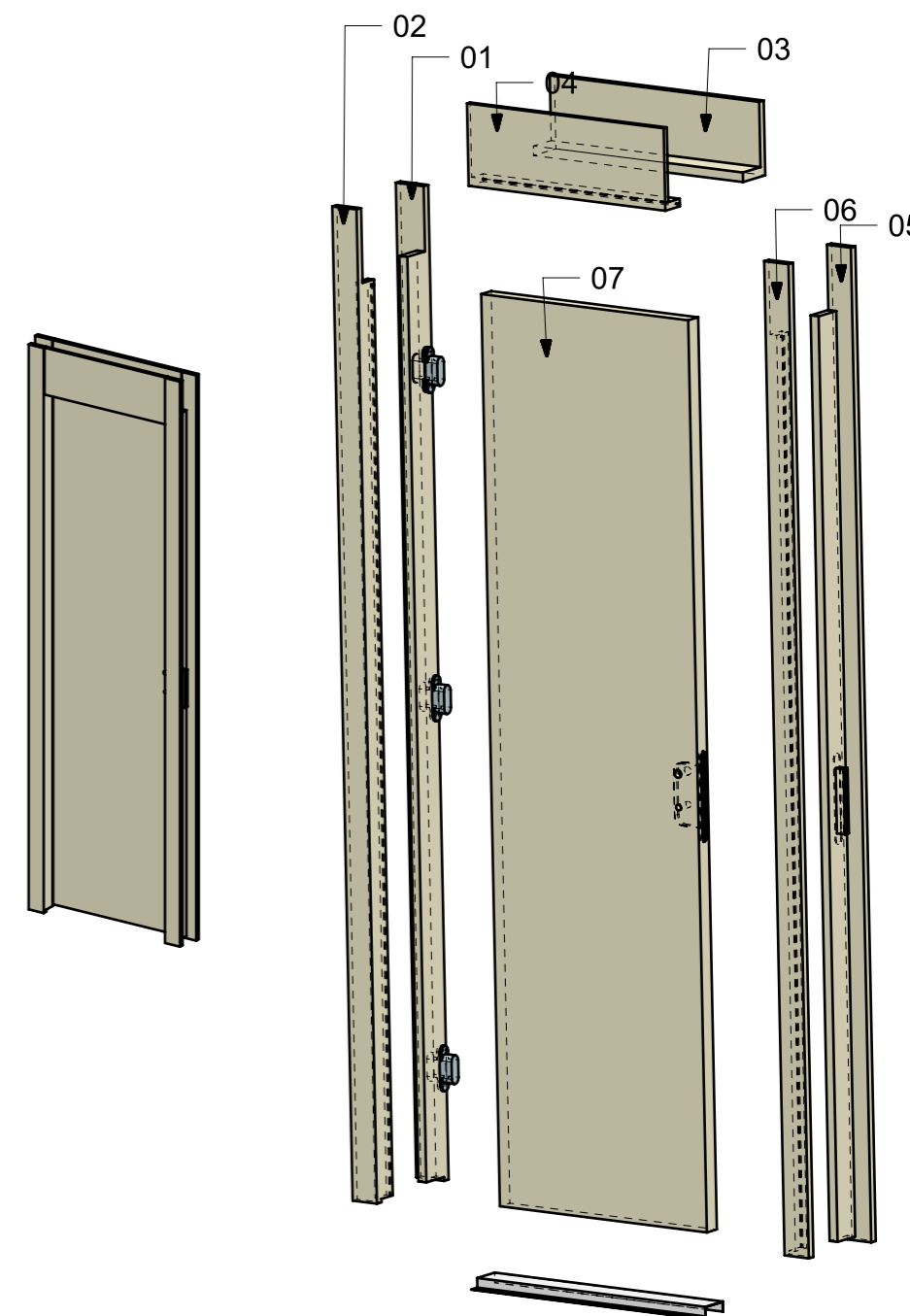

03

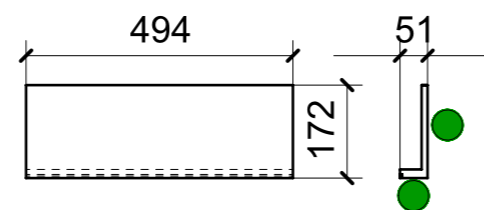

04

| FERRAMENTA  | QTY |
|---|-----|
| GUARNIZIONE X PORTE MARRONE_FBC_ART_A106K                       | 1   |
| CERNIERA INVISIBILE KOBLENZ_FBC_COD K6200 20 CL                 | 3   |
| CONTROPIASTRA MAGNETICA CROMO LUCIDO 992 CR L_FBC               | 1   |
| SERRATURA MAGNETICA B-ONE CROMATO LUCIDO 901 (INTERASSE 70)_FBC | 1   |

VERNICIATURA LASTRA/LACCATI:

● = VERNICIARE 1 LATO + FILI RASATI O BORDATI

NESSUN SIMBOLO = VERNICIARE 2 LATI + FILI RASATI O BORDATI

| LOCALE | CODICE       | DESCRIZIONE COMPONENTE             | FINITURA | Q.TA |
|--------|--------------|------------------------------------|----------|------|
| PORTE  | MD299_A01_P5 | PORTA BAGNO OSPITI SX DA CORRIDOIO | ACCIAIO  | 1    |

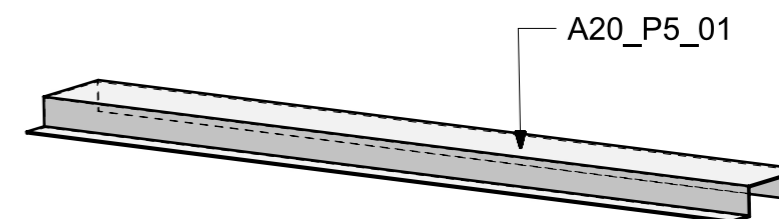
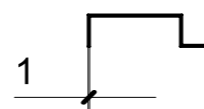
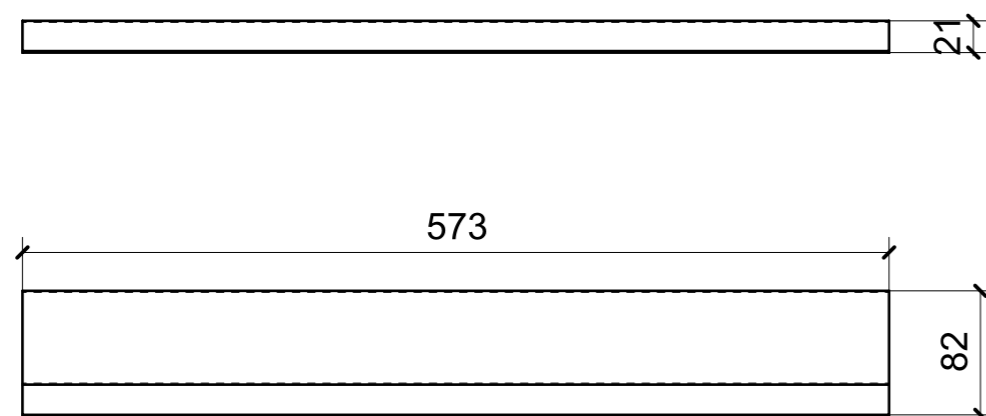

A20\_P5\_01

| LOCALE | CODICE      | DESCRIZIONE COMPONENTE              | FINITURA     | Q.TA |
|--------|-------------|-------------------------------------|--------------|------|
| PORTE  | MD299_MG_P6 | PORTA CABINA OSPITI DX DA CORRIDOIO | LASTRA SCURA | 1    |

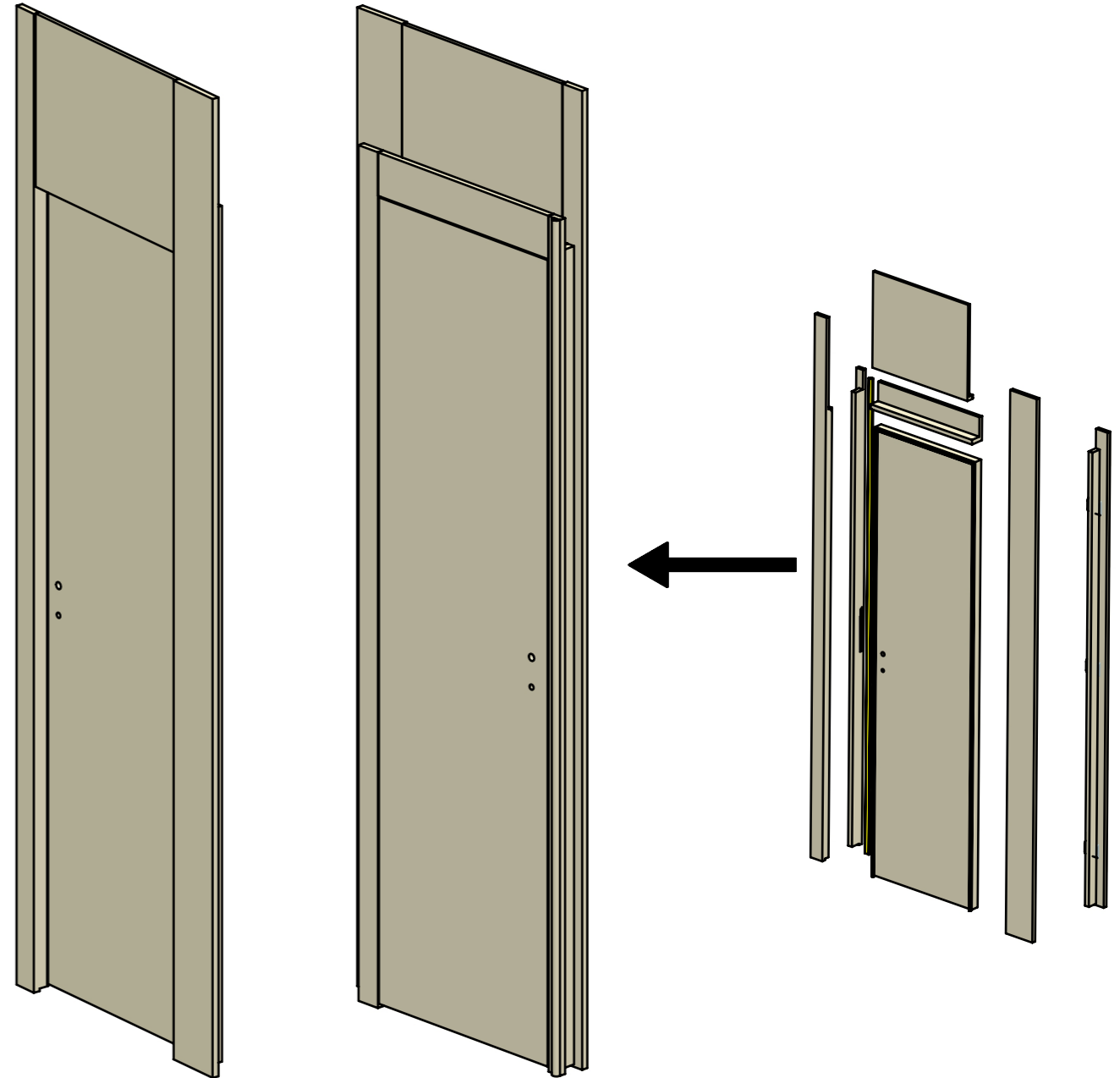
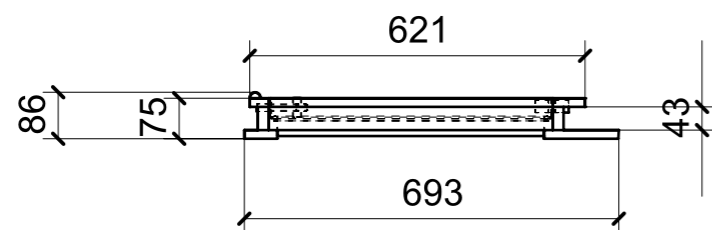
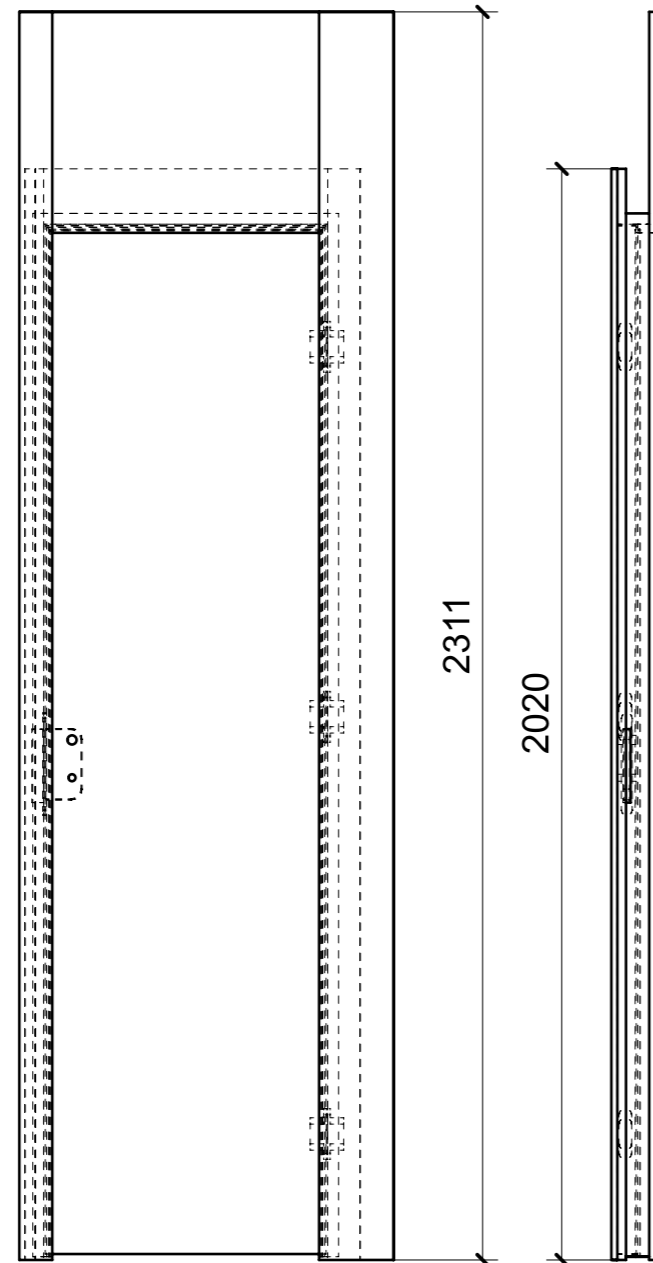

| FERRAMENTA  | QTY |
|---|-----|
| GUARNIZIONE X PORTE MARRONE_FBC_ART_A106K                       | 1   |
| CERNIERA INVISIBILE KOBLENZ_FBC_COD K6200 20 CL                 | 3   |
| CONTROPIASTRA MAGNETICA CROMO LUCIDO 992 CR L_FBC               | 1   |
| SERRATURA MAGNETICA B-ONE CROMATO LUCIDO 901 (INTERASSE 70)_FBC | 1   |

| LOCALE | CODICE       | DESCRIZIONE COMPONENTE              | FINITURA     | Q.TA |
|--------|--------------|-------------------------------------|--------------|------|
| PORTE  | MD299_R01_P6 | PORTA CABINA OSPITI DX DA CORRIDOIO | LASTRA SCURA | 1    |

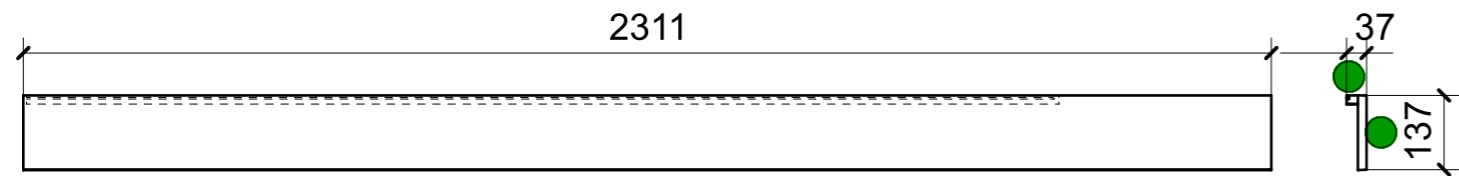

01

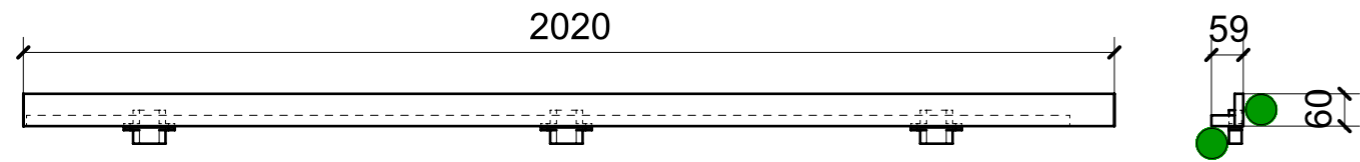

02

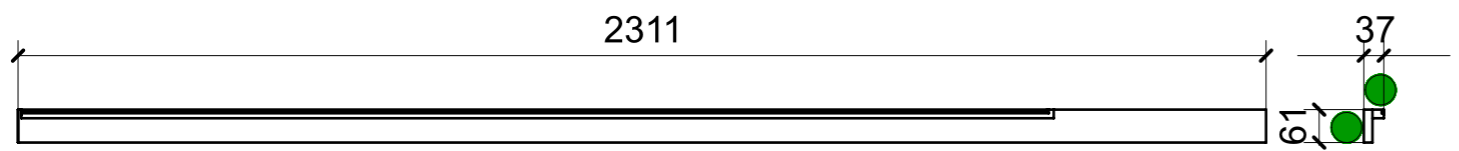

05

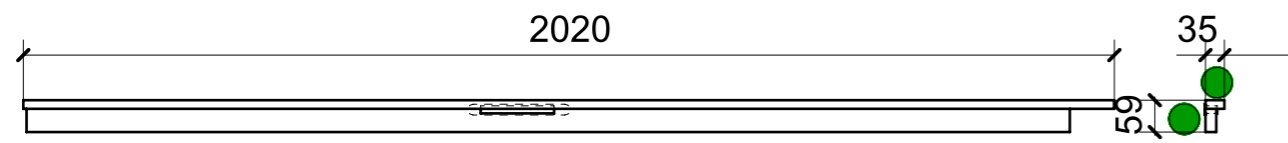

06

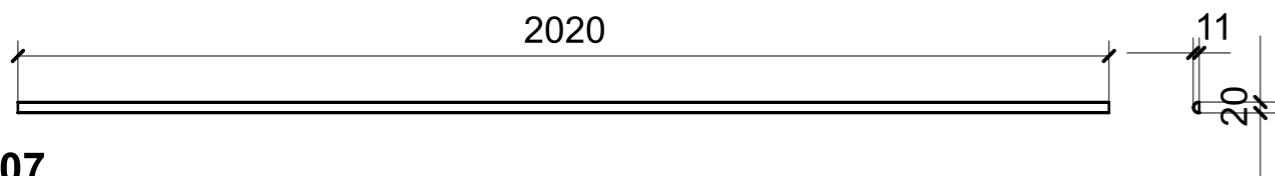

07

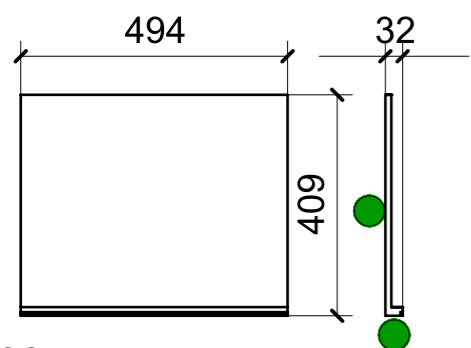

03

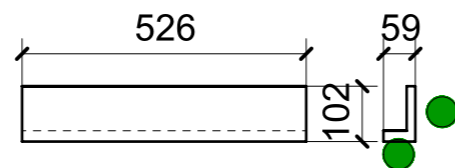

04

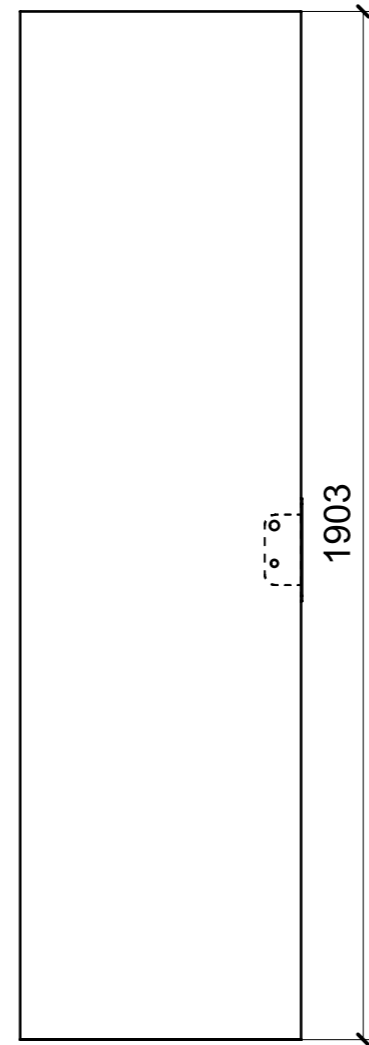

08

ELEMENTI DA MONTARE IN MG\_P6  
e spedire con unico imballo

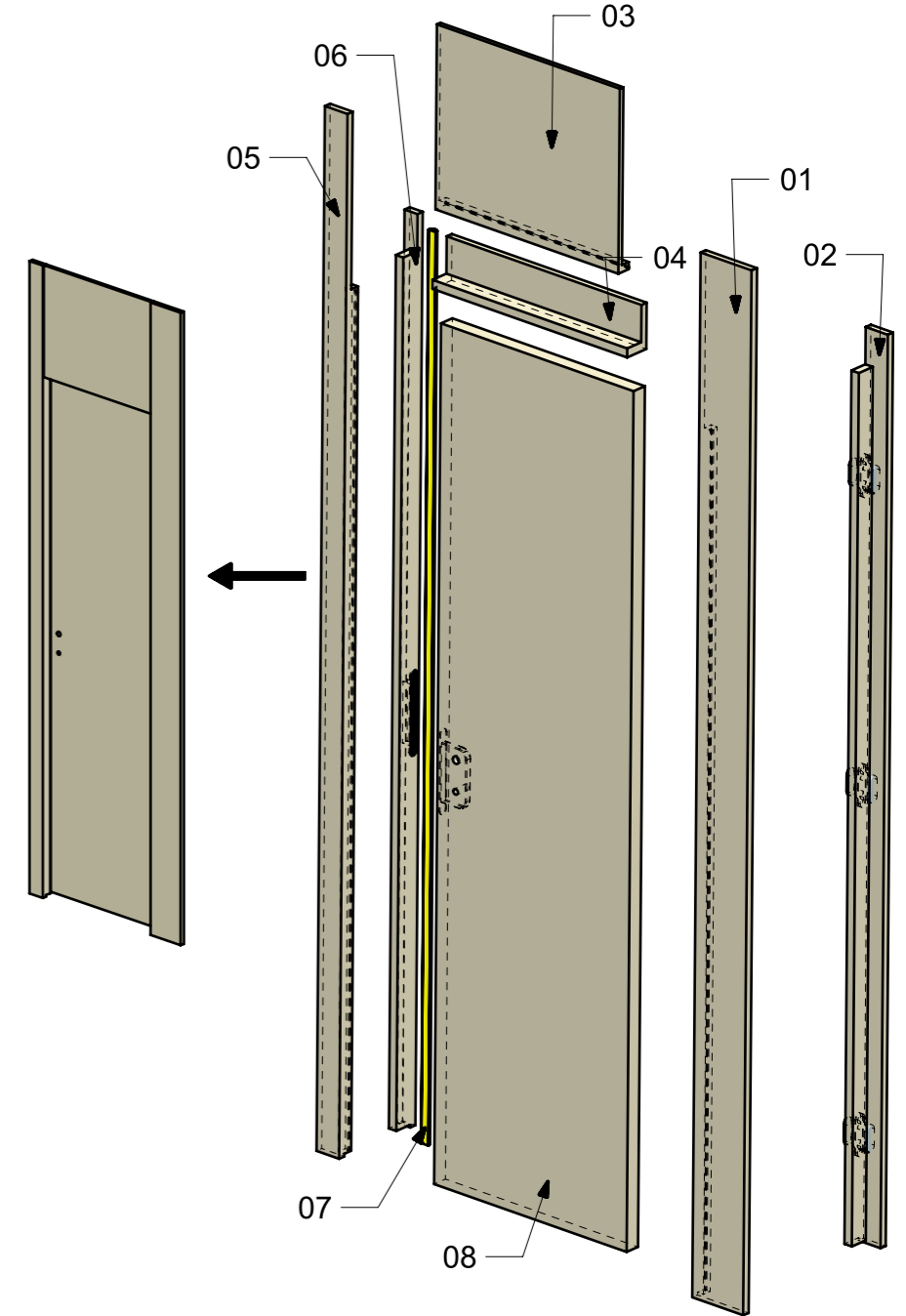

| FERRAMENTA  | QTY |
|---|-----|
| GUARNIZIONE X PORTE MARRONE_FBC_ART_A106K                       | 1   |
| CERNIERA INVISIBILE KOBLENZ_FBC_COD K6200 20 CL                 | 3   |
| CONTROPIASTRA MAGNETICA CROMO LUCIDO 992 CR L_FBC               | 1   |
| SERRATURA MAGNETICA B-ONE CROMATO LUCIDO 901 (INTERASSE 70)_FBC | 1   |

VERNICIATURA LASTRA/LACCATI:

● = VERNICIARE 1 LATO + FILI RASATI O BORDATI

NESSUN SIMBOLO = VERNICIARE 2 LATI + FILI RASATI O BORDATI

| LOCALE | CODICE       | DESCRIZIONE COMPONENTE              | FINITURA | Q.TA |
|--------|--------------|-------------------------------------|----------|------|
| PORTE  | MD299_A01_P6 | PORTA CABINA OSPITI DX DA CORRIDOIO | ACCIAIO  | 1    |

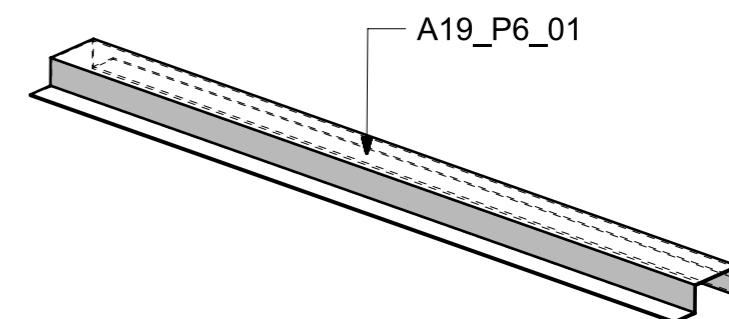
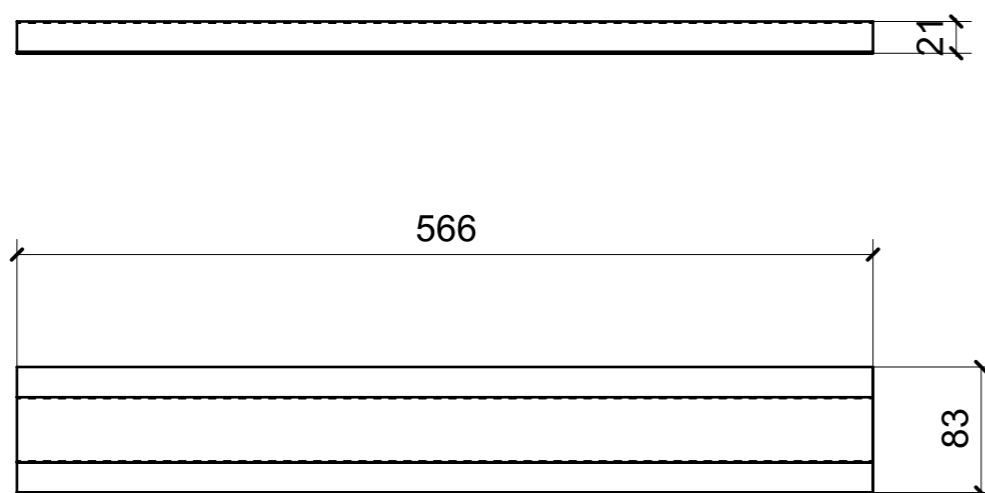

A19\_P6\_01

| LOCALE | CODICE      | DESCRIZIONE COMPONENTE | FINITURA     | Q.TA |
|--------|-------------|------------------------|--------------|------|
| PORTE  | MD299_MG_P7 | PORTA BAGNO OSPITI DX  | LASTRA SCURA | 1    |

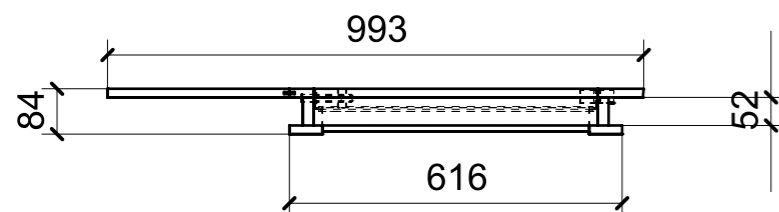
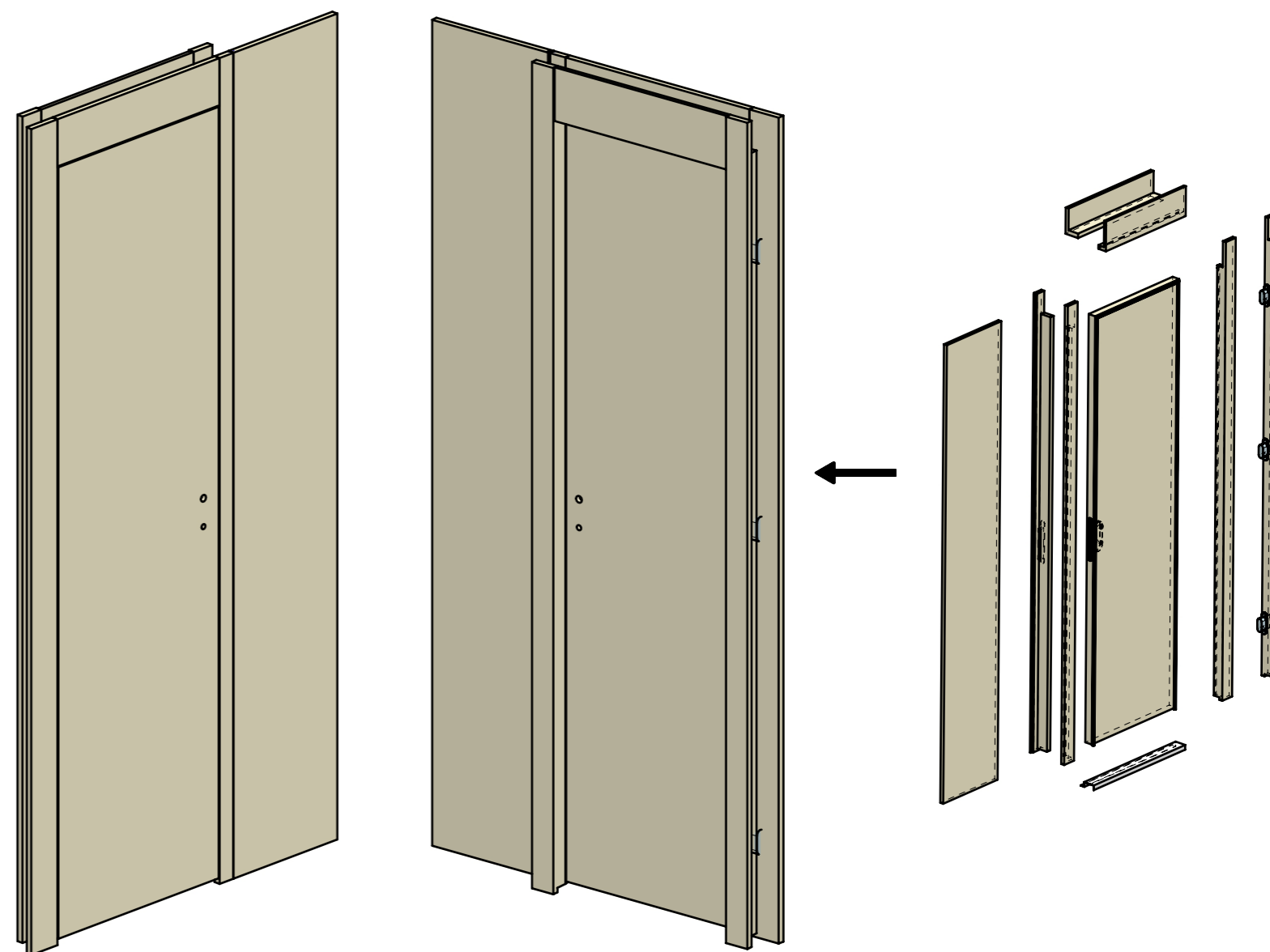
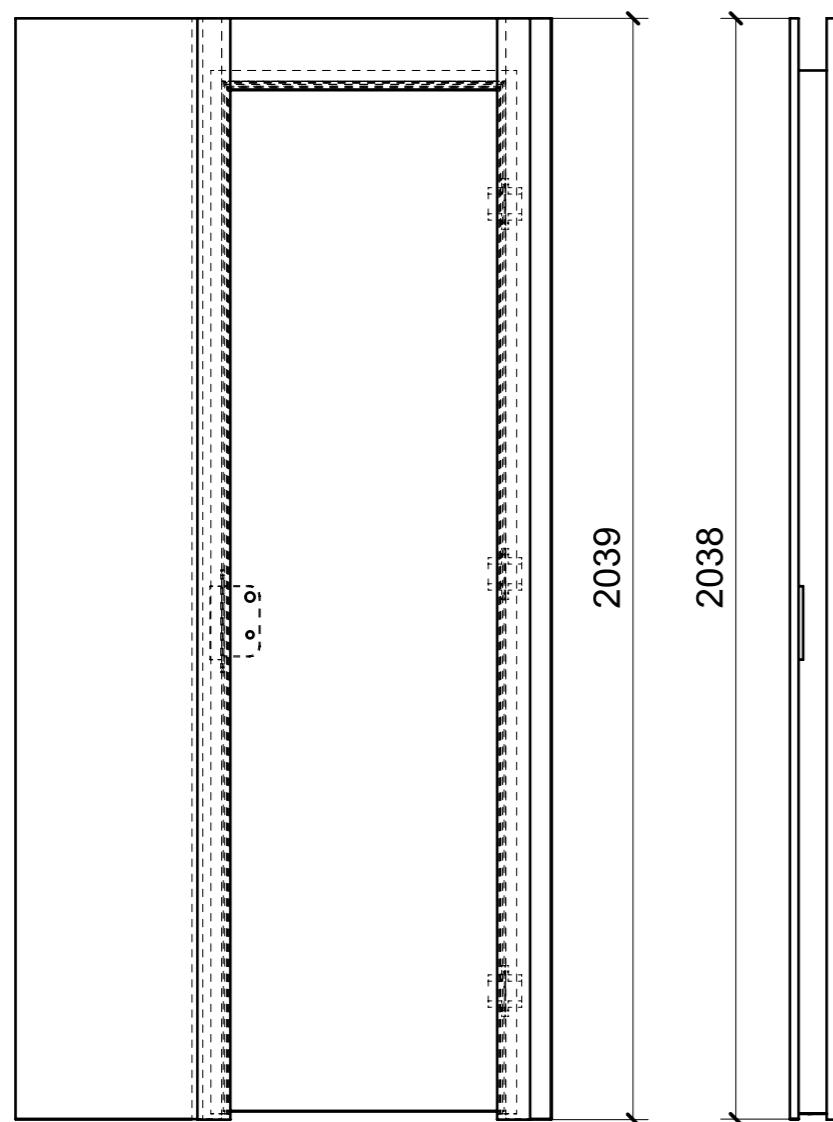

| FERRAMENTA  | QTY |
|---|-----|
| GUARNIZIONE X PORTE MARRONE_FBC_ART_A106K                       | 1   |
| CERNIERA INVISIBILE KOBLENZ_FBC_COD K6200 20 CL                 | 3   |
| CONTROPIASTRA MAGNETICA CROMO LUCIDO 992 CR L_FBC               | 1   |
| SERRATURA MAGNETICA B-ONE CROMATO LUCIDO 901 (INTERASSE 70)_FBC | 1   |

| LOCALE | CODICE       | DESCRIZIONE COMPONENTE | FINITURA     | Q.TA |
|--------|--------------|------------------------|--------------|------|
| PORTE  | MD299_R01_P7 | PORTA BAGNO OSPITI DX  | LASTRA SCURA | 1    |

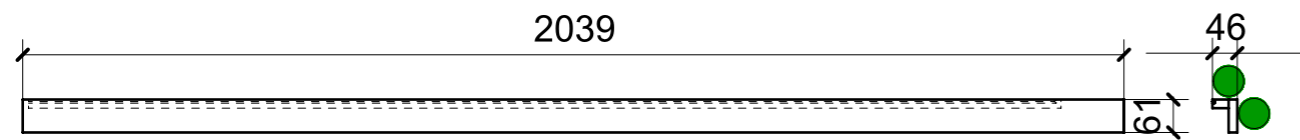

01

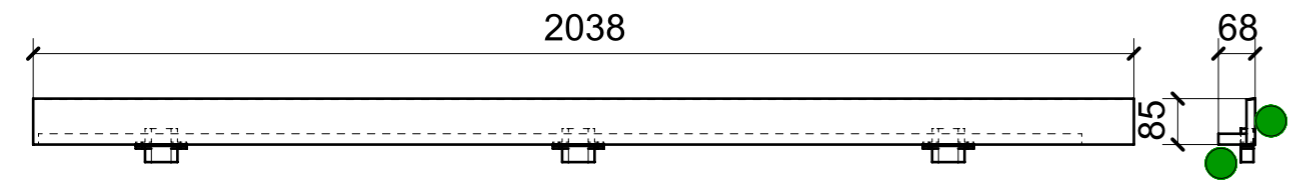

02

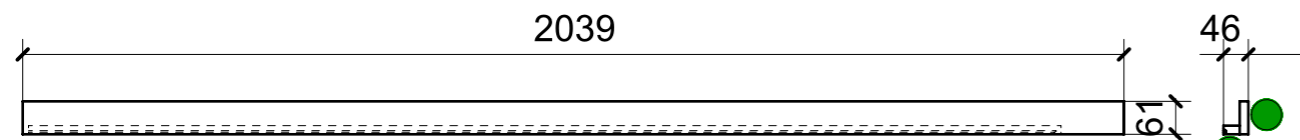

05

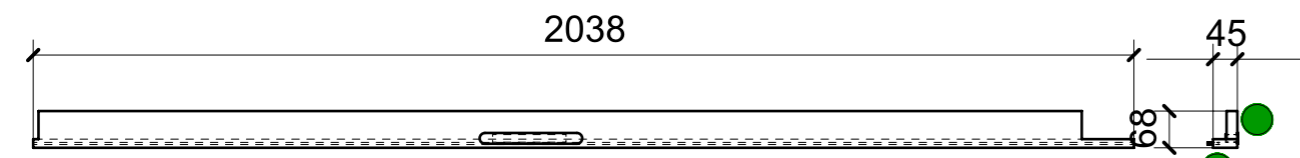

06

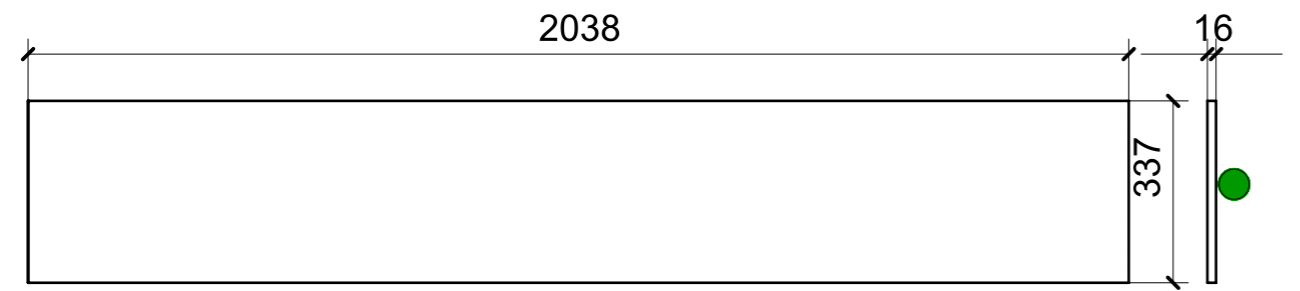

07

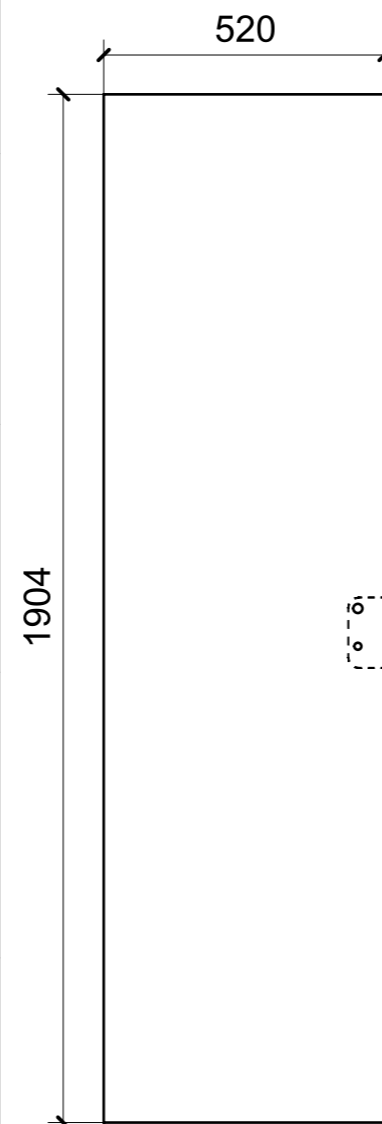

08

ELEMENTO DA MONTARE CON IN MG\_P7  
e spedire con unico imballo

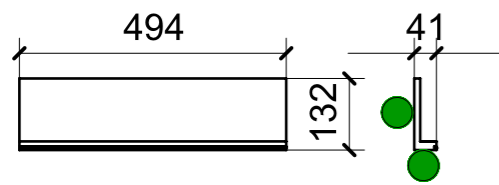
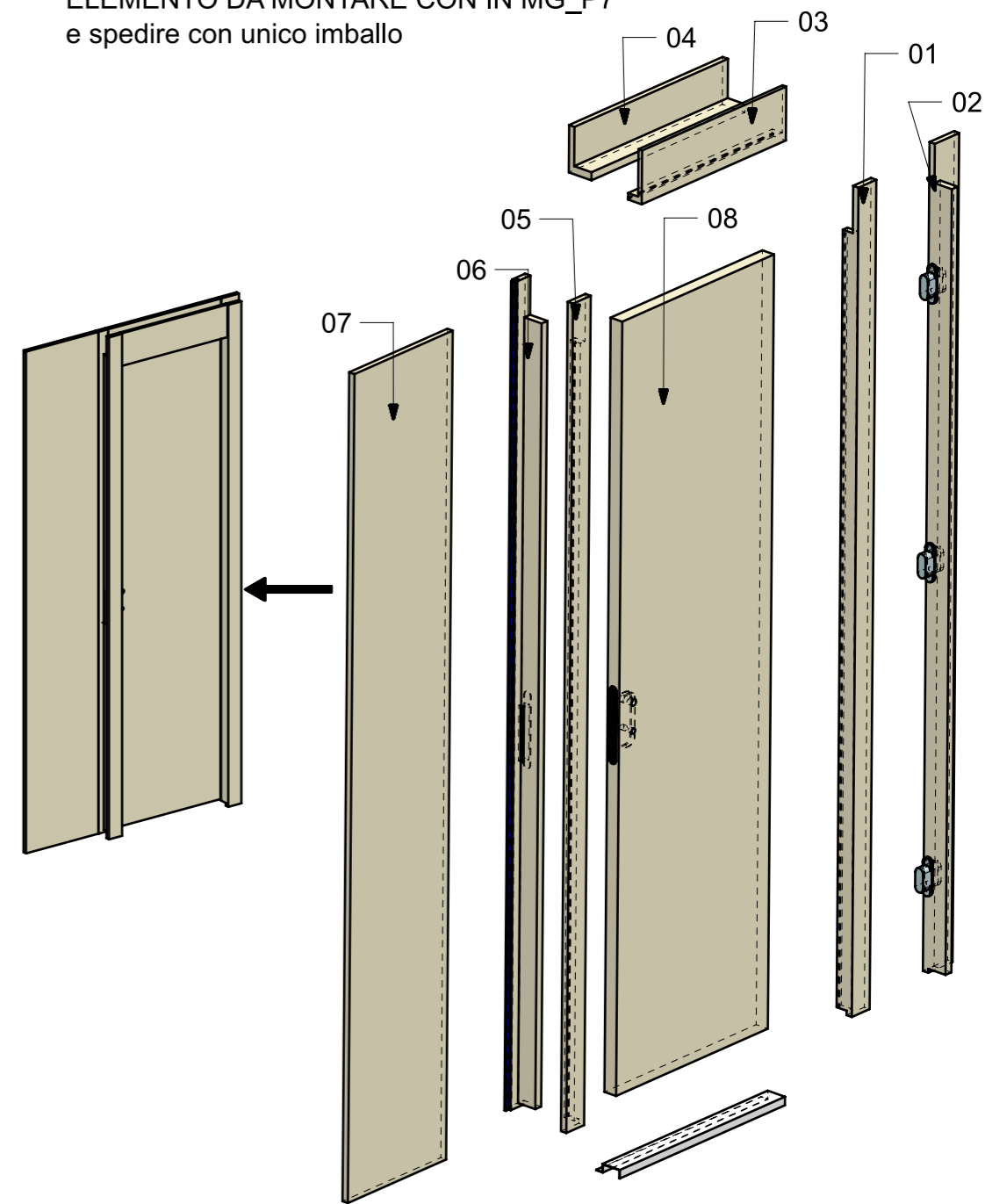

03

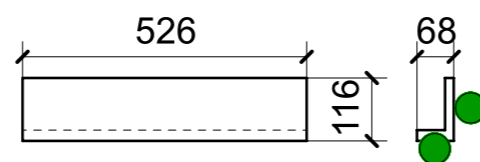

04

| FERRAMENTA  | QTY |
|---|-----|
| GUARNIZIONE X PORTE MARRONE_FBC_ART_A106K                       | 1   |
| CERNIERA INVISIBILE KOBLENZ_FBC_COD K6200 20 CL                 | 3   |
| CONTROPIASTRA MAGNETICA CROMO LUCIDO 992 CR L_FBC               | 1   |
| SERRATURA MAGNETICA B-ONE CROMATO LUCIDO 901 (INTERASSE 70)_FBC | 1   |

VERNICIATURA LASTRA/LACCATI:

● = VERNICIARE 1 LATO + FILI RASATI O BORDATI

NESSUN SIMBOLO = VERNICIARE 2 LATI + FILI RASATI O BORDATI

| LOCALE | CODICE       | DESCRIZIONE COMPONENTE | FINITURA | Q.TA |
|--------|--------------|------------------------|----------|------|
| PORTE  | MD299_A01_P7 | PORTA BAGNO OSPITI DX  | ACCIAIO  | 1    |

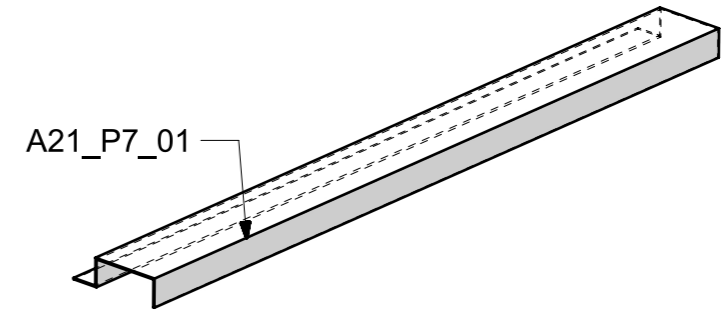
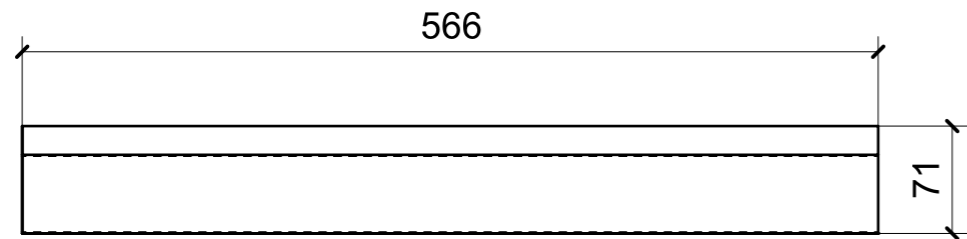
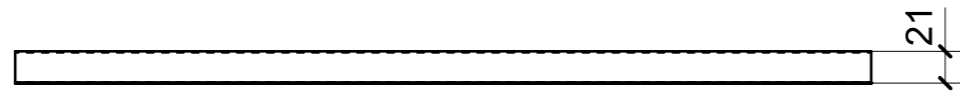

A21\_P7\_01

| LOCALE | CODICE      | DESCRIZIONE COMPONENTE | FINITURA     | Q.TA |
|--------|-------------|------------------------|--------------|------|
| PORTE  | MD299_MG_P8 | PORTA BAGNO VIP        | LASTRA SCURA | 1    |

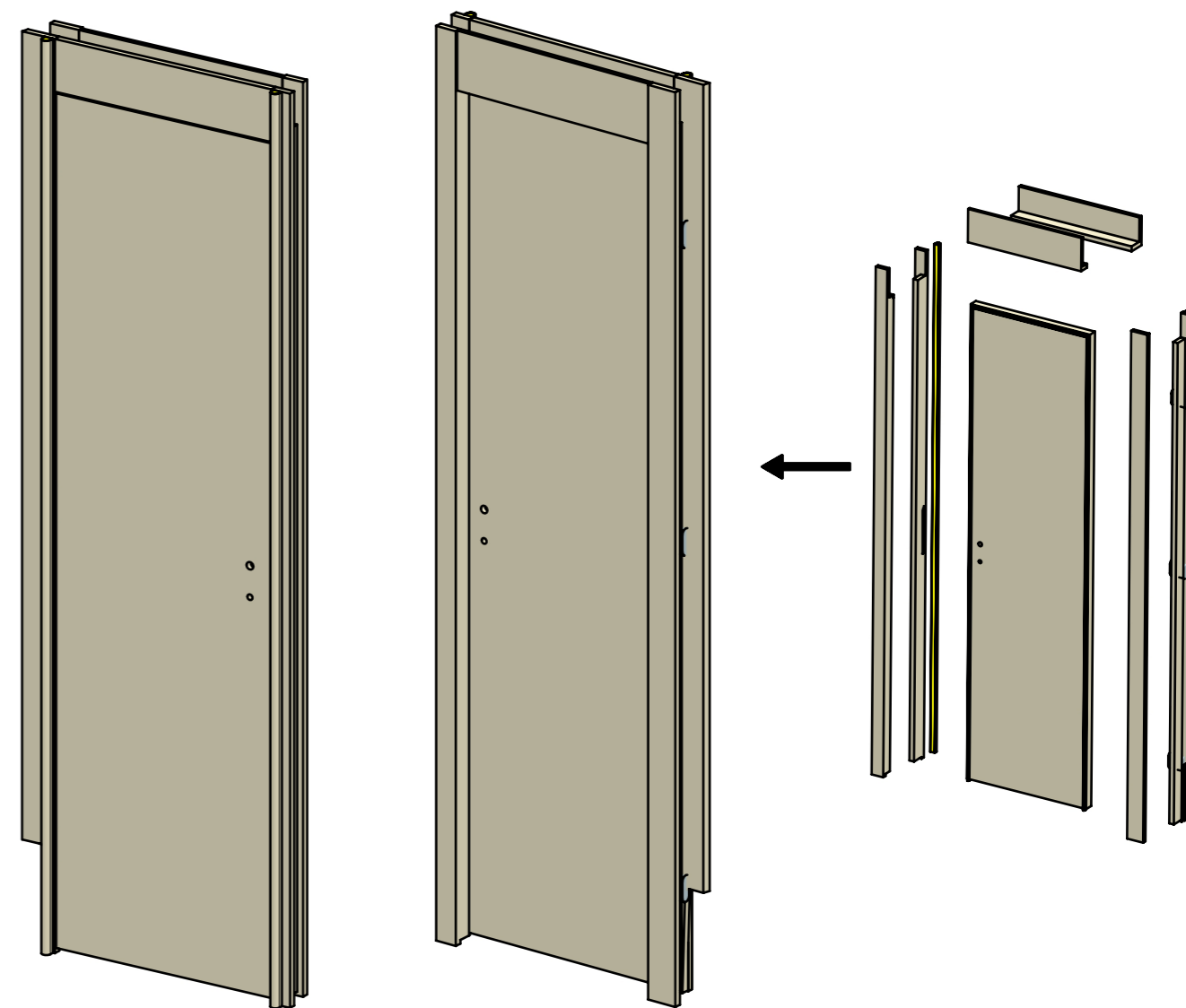
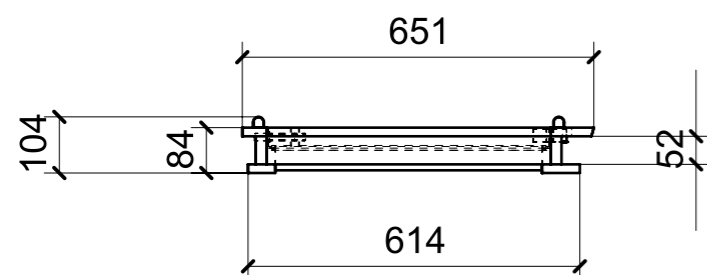
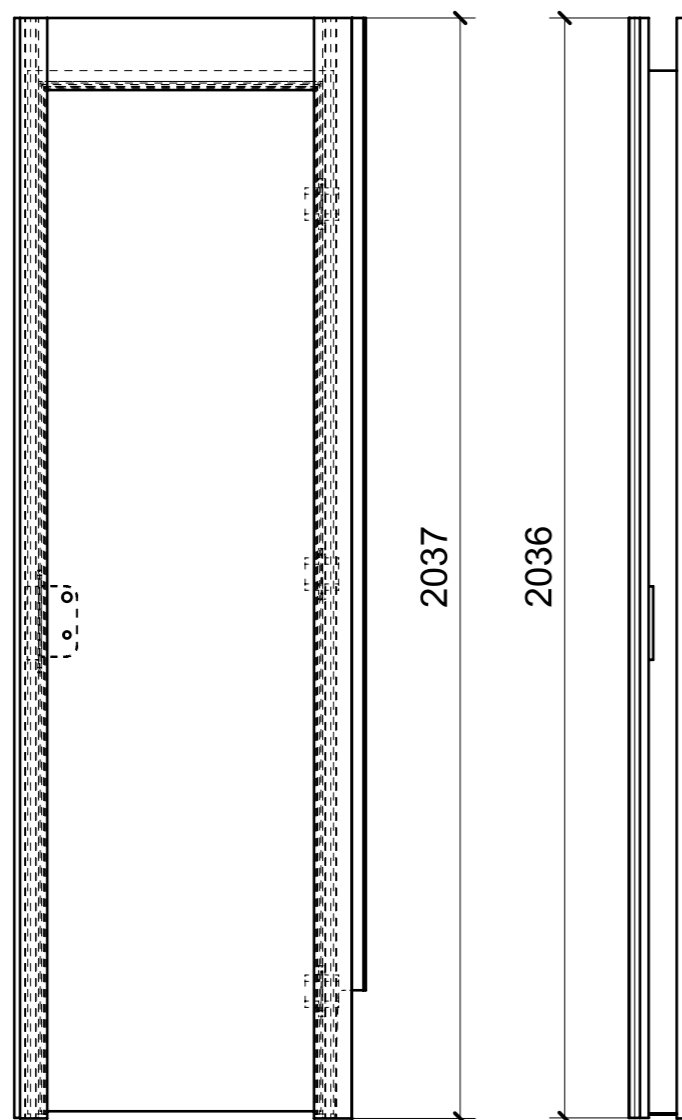

| FERRAMENTA  | QTY |
|---|-----|
| GUARNIZIONE X PORTE MARRONE_FBC_ART_A106K                       | 1   |
| CERNIERA INVISIBILE KOBLENZ_FBC_COD K6200 20 CL                 | 3   |
| CONTROPIASTRA MAGNETICA CROMO LUCIDO 992 CR L_FBC               | 1   |
| SERRATURA MAGNETICA B-ONE CROMATO LUCIDO 901 (INTERASSE 70)_FBC | 1   |

| LOCALE | CODICE       | DESCRIZIONE COMPONENTE | FINITURA     | Q.TA |
|--------|--------------|------------------------|--------------|------|
| PORTE  | MD299_R01_P8 | PORTA BAGNO VIP        | LASTRA SCURA | 1    |

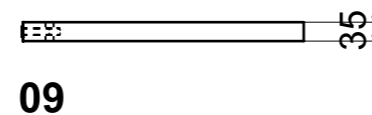
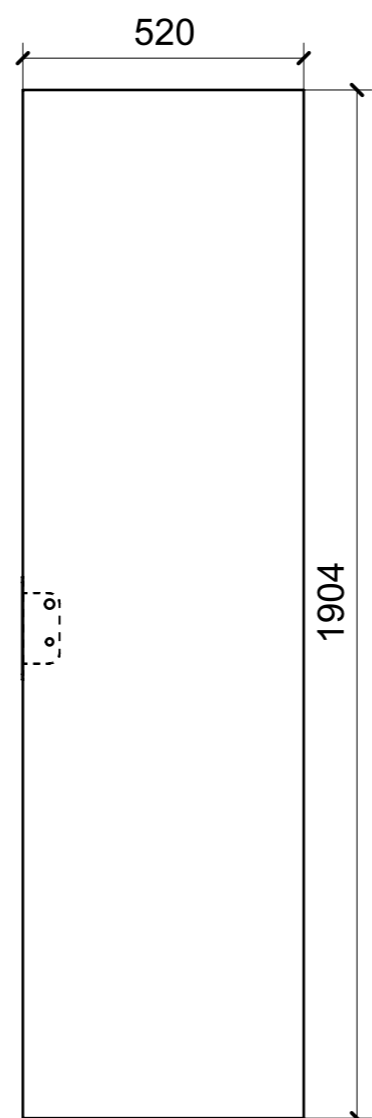
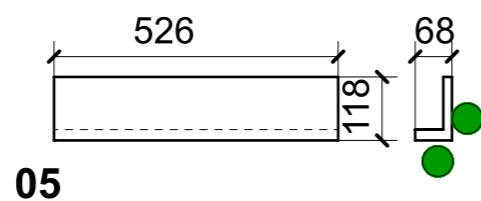
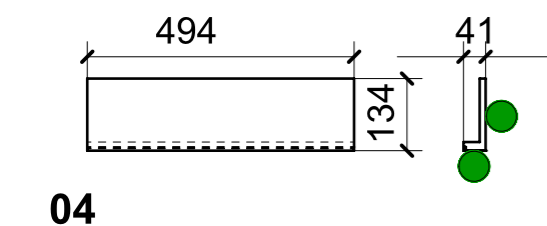
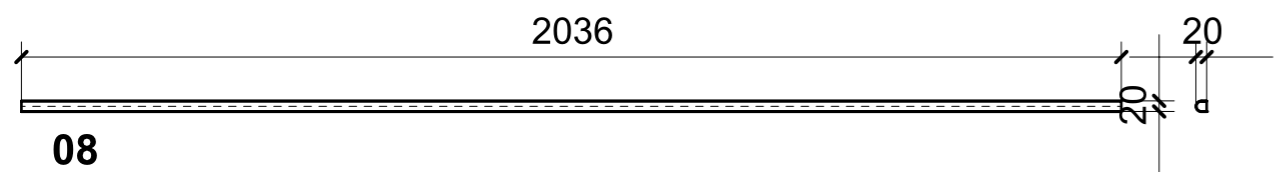
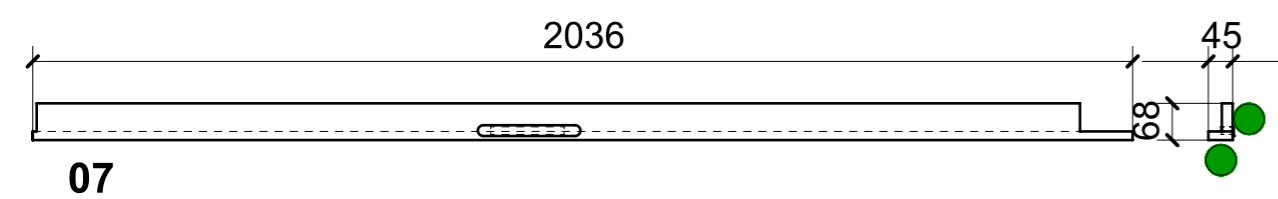
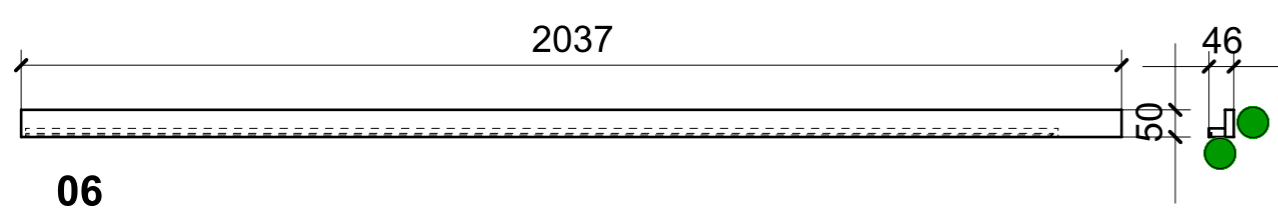
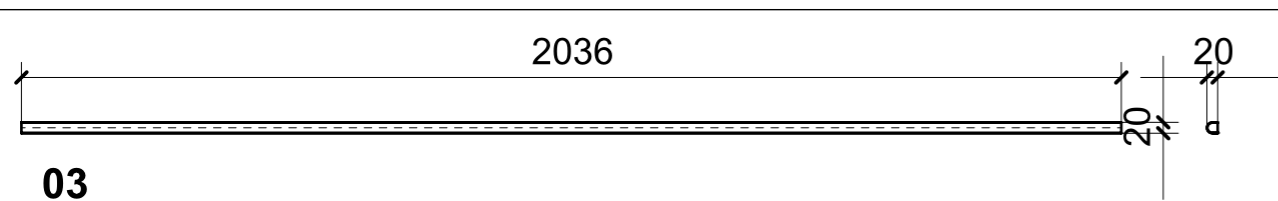
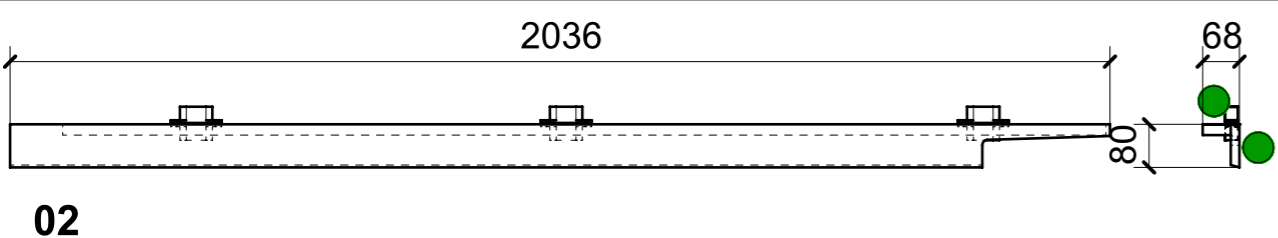
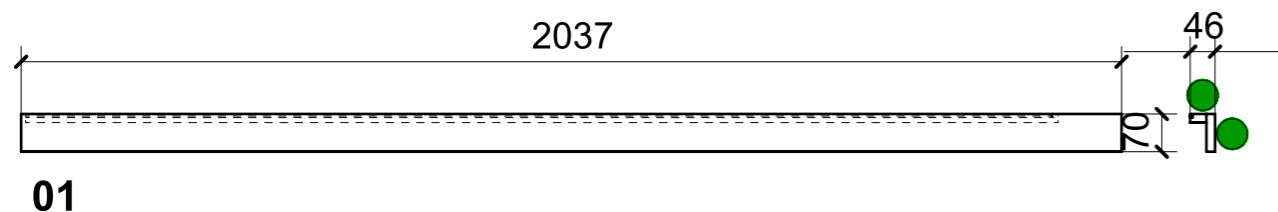

ELEMENTI DA MONTARE CON IN MG\_P8  
e spedire con unico imballo

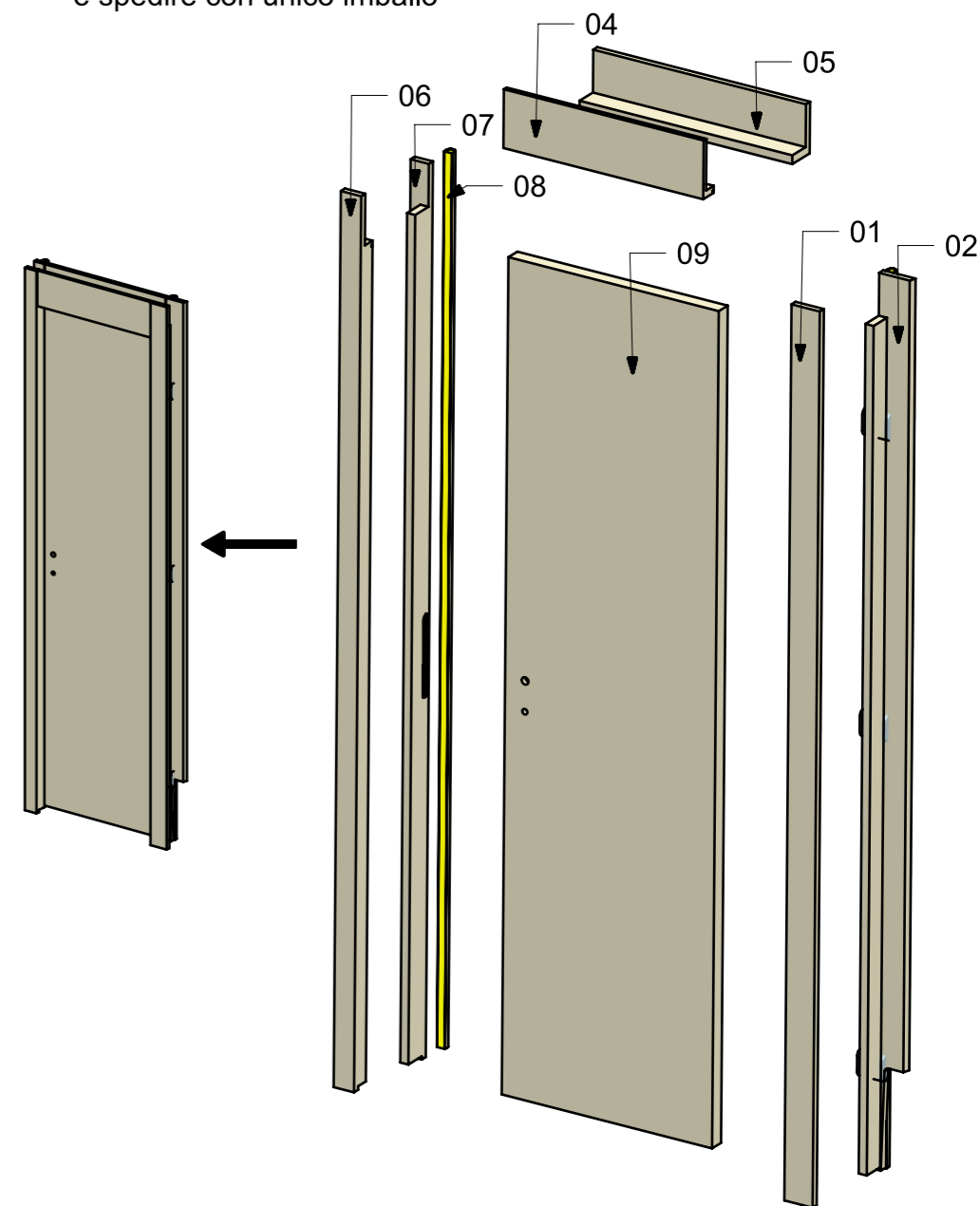

| FERRAMENTA  | QTY |
|---|-----|
| GUARNIZIONE X PORTE MARRONE_FBC_ART_A106K                       | 1   |
| CERNIERA INVISIBILE KOBLENZ_FBC_COD K6200 20 CL                 | 3   |
| CONTROPIASTRA MAGNETICA CROMO LUCIDO 992 CR L_FBC               | 1   |
| SERRATURA MAGNETICA B-ONE CROMATO LUCIDO 901 (INTERASSE 70)_FBC | 1   |

VERNICIATURA LASTRA/LACCATI:

● = VERNICIARE 1 LATO + FILI RASATI O BORDATI

NESSUN SIMBOLO = VERNICIARE 2 LATI + FILI RASATI O BORDATI

| LOCALE | CODICE       | DESCRIZIONE COMPONENTE | FINITURA | Q.TA |
|--------|--------------|------------------------|----------|------|
| PORTE  | MD299_A01_P8 | PORTA BAGNO VIP        | ACCIAIO  | 1    |

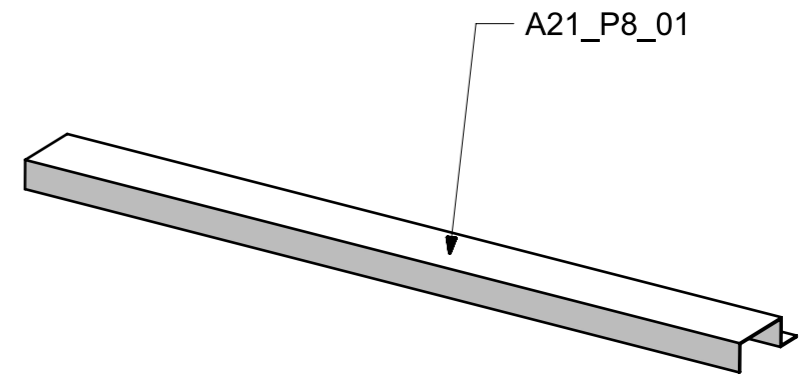
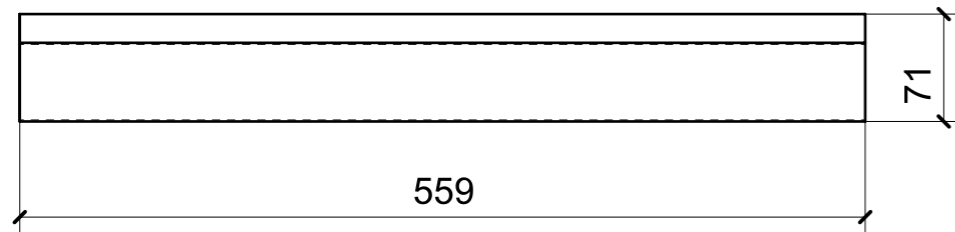
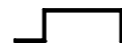
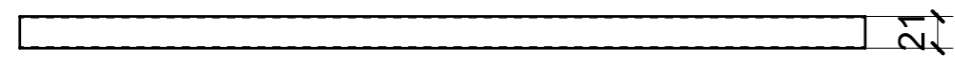

A21\_P8\_01

| LOCALE | CODICE      | DESCRIZIONE COMPONENTE    | FINITURA     | Q.TA |
|--------|-------------|---------------------------|--------------|------|
| PORTE  | MD299_MG_P9 | PORTA INGRESSO CABINA VIP | LASTRA SCURA | 1    |

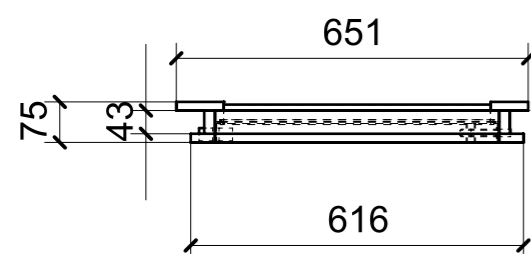
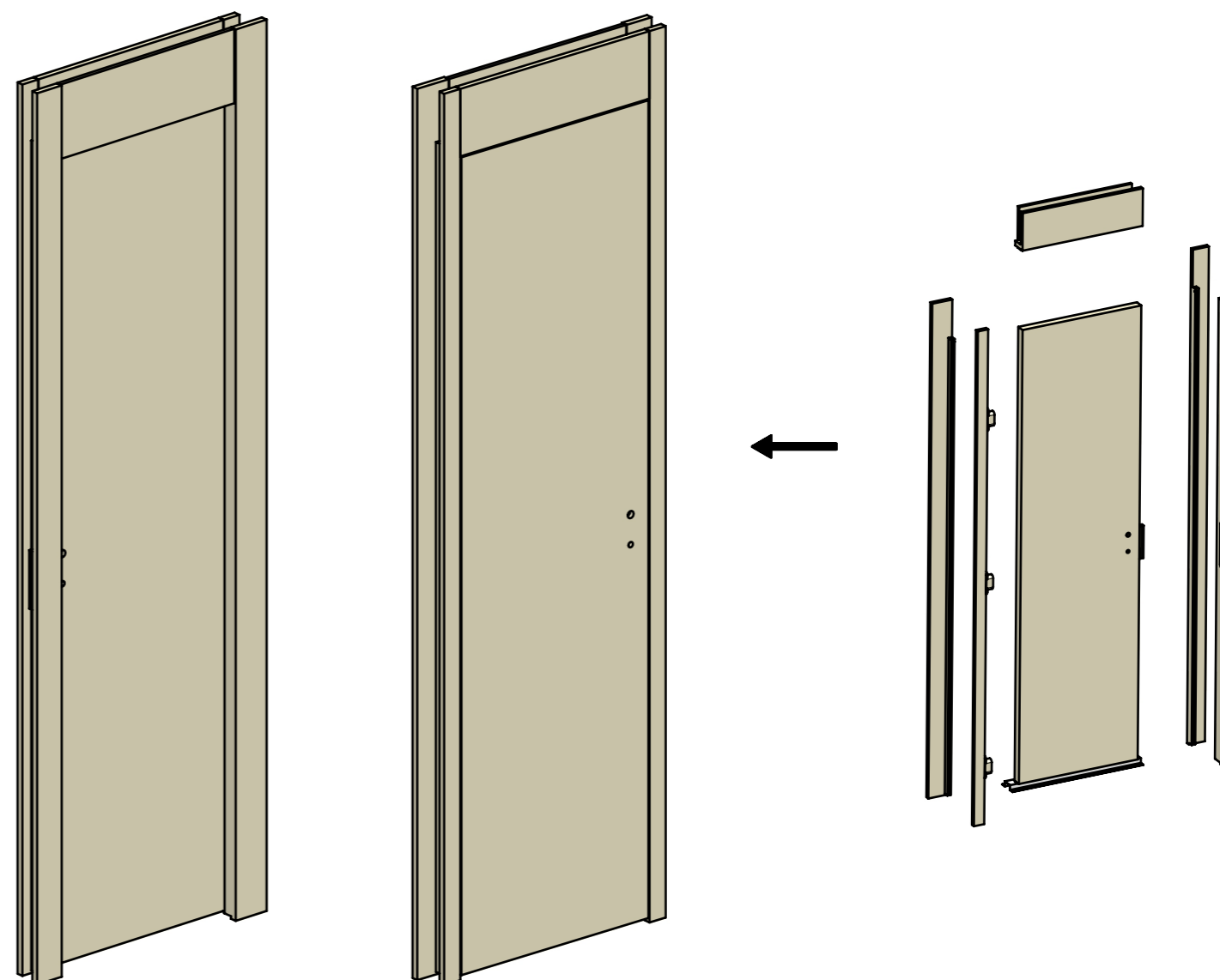
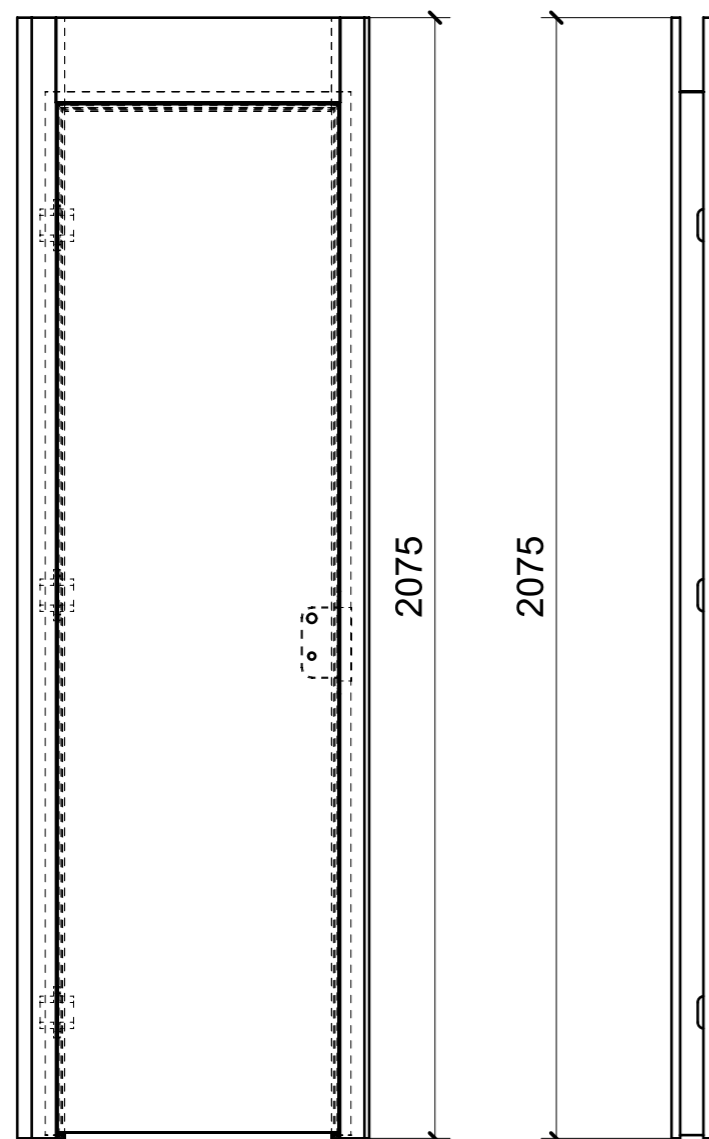

| FERRAMENTA  | QTY |
|---|-----|
| GUARNIZIONE X PORTE MARRONE_FBC_ART_A106K                       | 1   |
| CERNIERA INVISIBILE KOBLENZ_FBC_COD K6200 20 CL                 | 3   |
| CONTROPIASTRA MAGNETICA CROMO LUCIDO 992 CR L_FBC               | 2   |
| SERRATURA MAGNETICA B-ONE CROMATO LUCIDO 901 (INTERASSE 70)_FBC | 1   |

| LOCALE | CODICE       | DESCRIZIONE COMPONENTE    | FINITURA     | Q.TA |
|--------|--------------|---------------------------|--------------|------|
| PORTE  | MD299_R01_P9 | PORTA INGRESSO CABINA VIP | LASTRA SCURA | 1    |

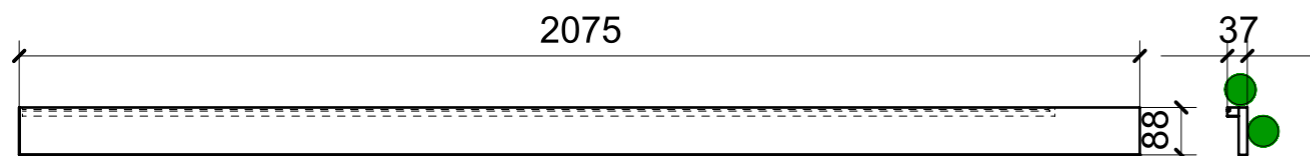

01

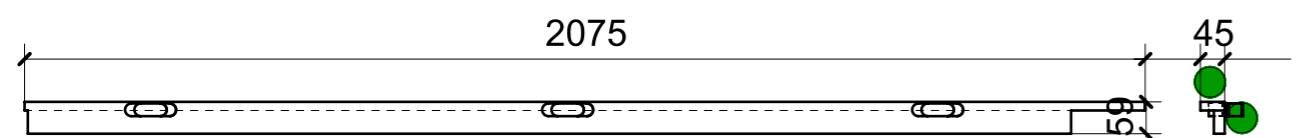

02

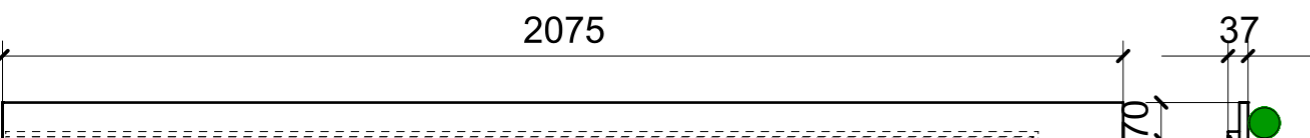

05

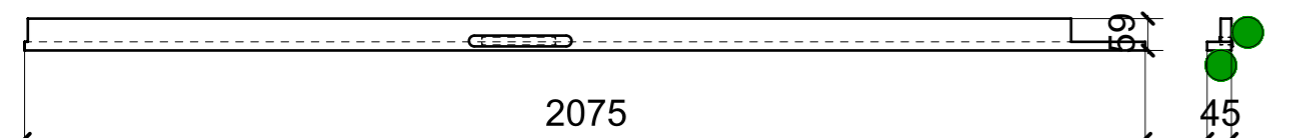

06

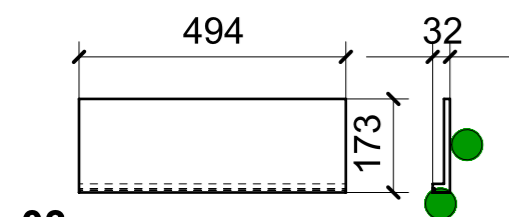

03

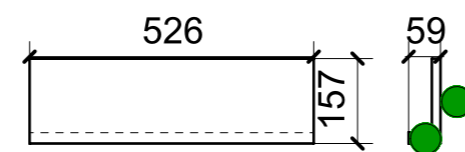

04

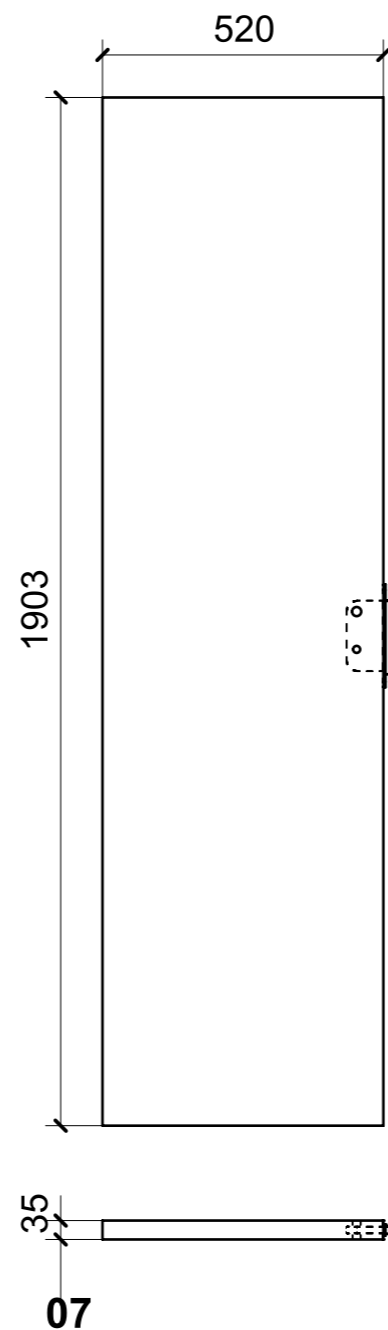

07

ELEMENTI DA MONTARE IN MG\_P9  
e spedire con unico imballo

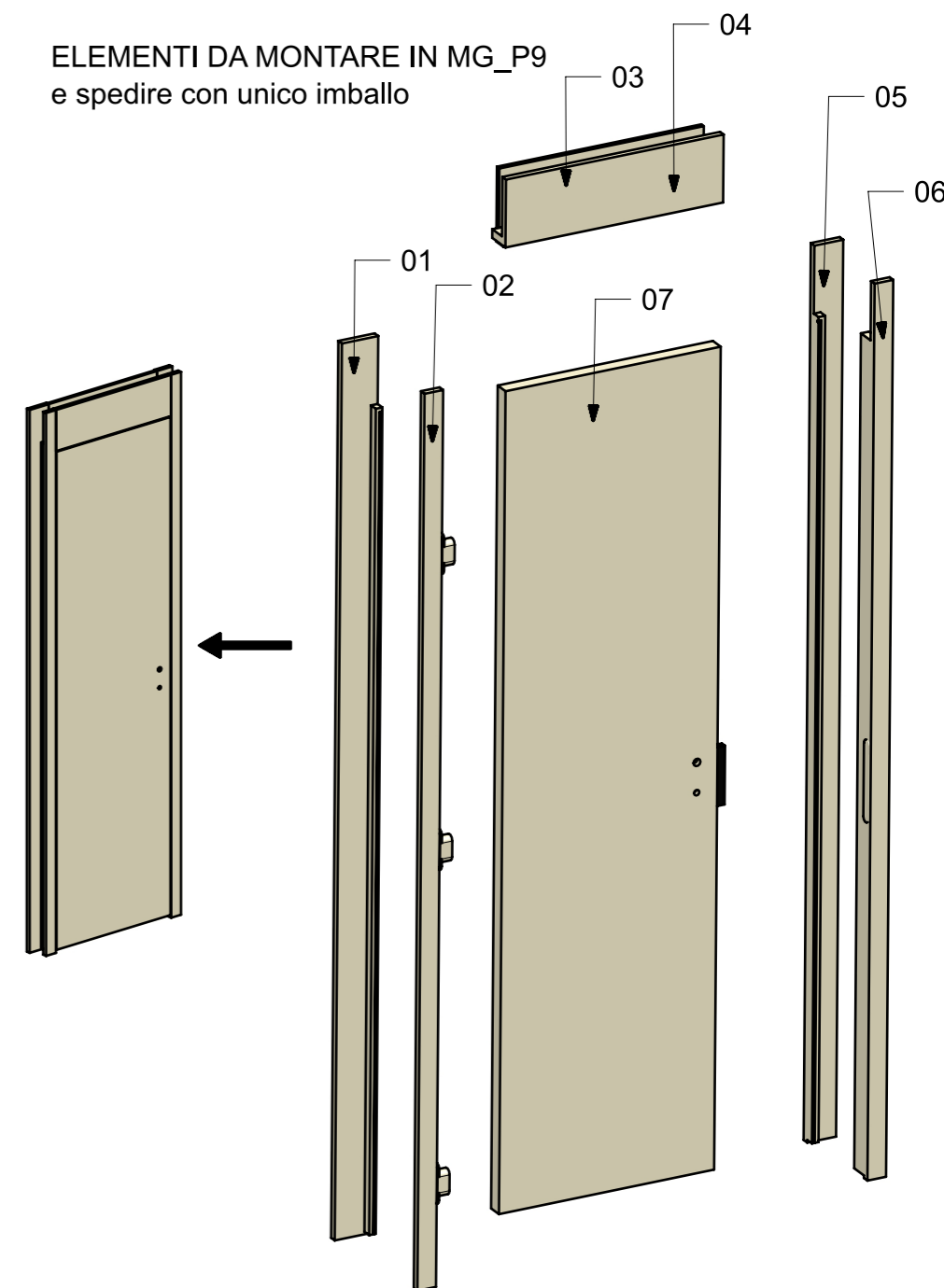

| FERRAMENTA  | QTY |
|---|-----|
| GUARNIZIONE X PORTE MARRONE_FBC_ART_A106K                       | 1   |
| CERNIERA INVISIBILE KOBLENZ_FBC_COD K6200 20 CL                 | 3   |
| SERRATURA MAGNETICA B-ONE CROMATO LUCIDO 901 (INTERASSE 70)_FBC | 1   |
| CONTROPIASTRA MAGNETICA CROMO LUCIDO 992 CR L_FBC               | 2   |

VERNICIATURA LASTRA/LACCATI:

● = VERNICIARE 1 LATO + FILI RASATI O BORDATI

NESSUN SIMBOLO = VERNICIARE 2 LATI + FILI RASATI O BORDATI

| LOCALE | CODICE       | DESCRIZIONE COMPONENTE    | FINITURA | Q.TA |
|--------|--------------|---------------------------|----------|------|
| PORTE  | MD299_A01_P9 | PORTA INGRESSO CABINA VIP | ACCIAIO  | 1    |

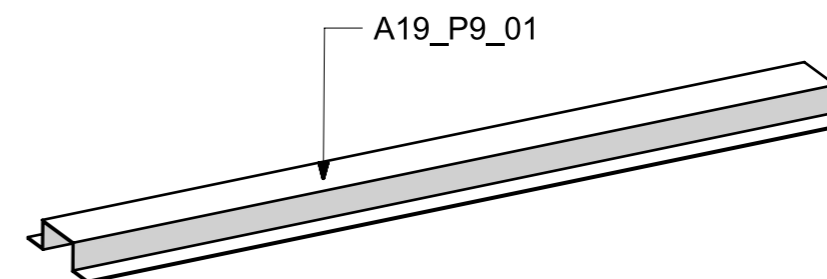
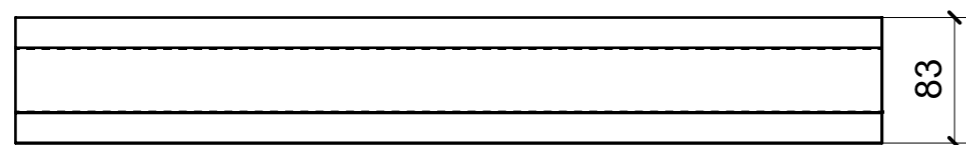
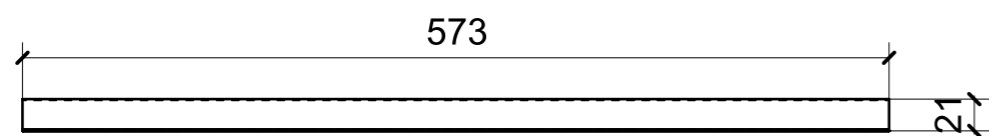

A19\_P9\_01