

LOCALE	CODICE	DESCRIZIONE COMPONENTE	FINITURA	Q.TA
PARATIE	MD299_PR01	PARATIA LUNGONAVE_CABINA OSPITI SX	OKUME' GREZZO	1

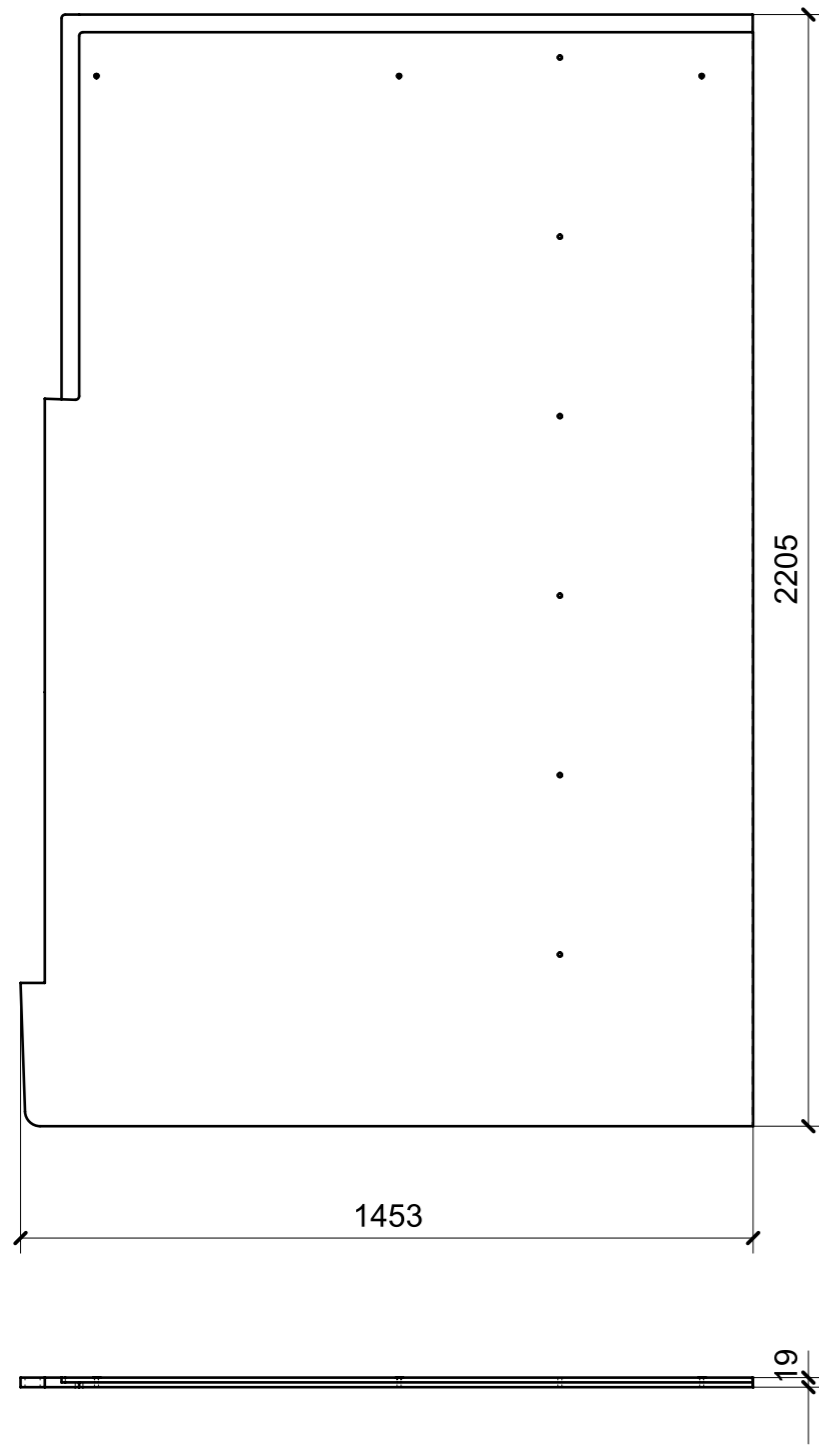

01

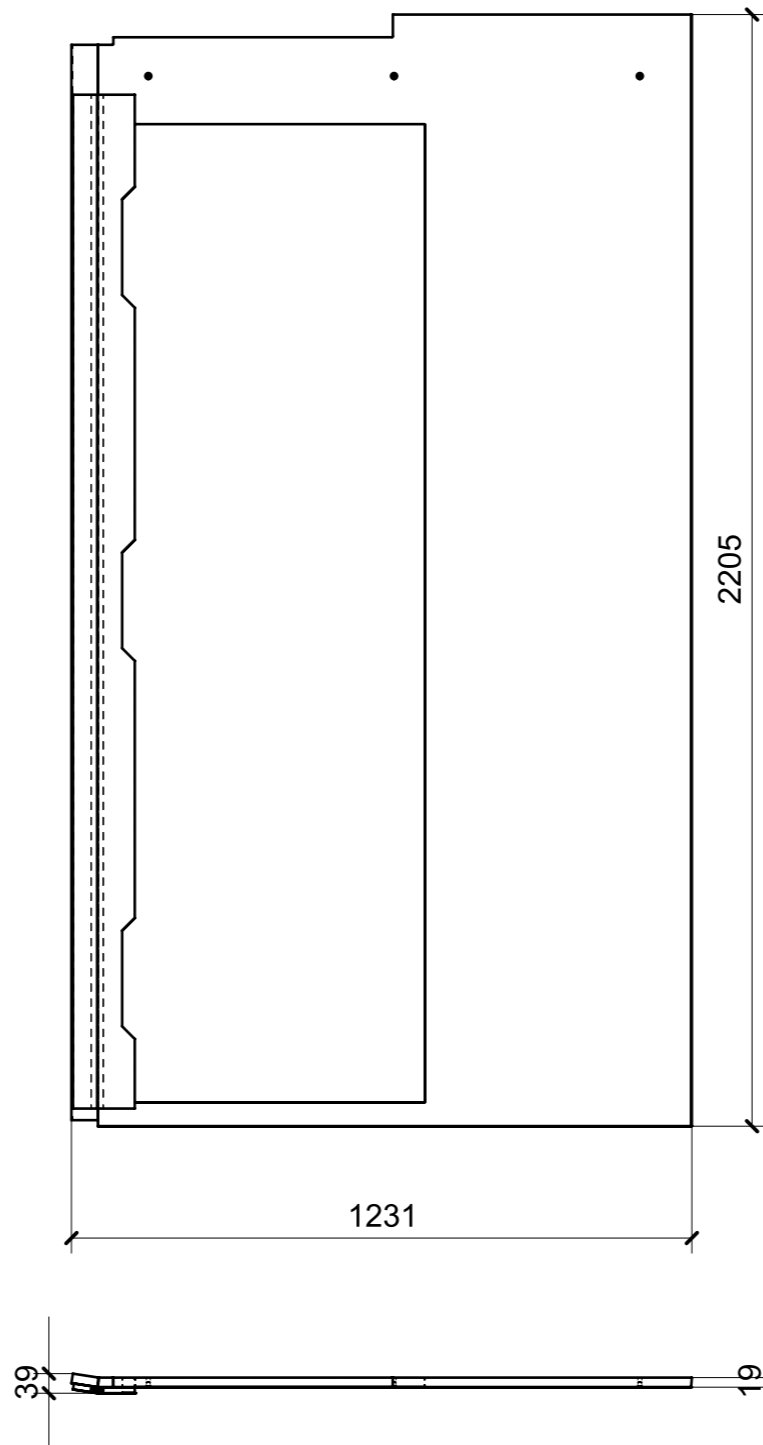

02

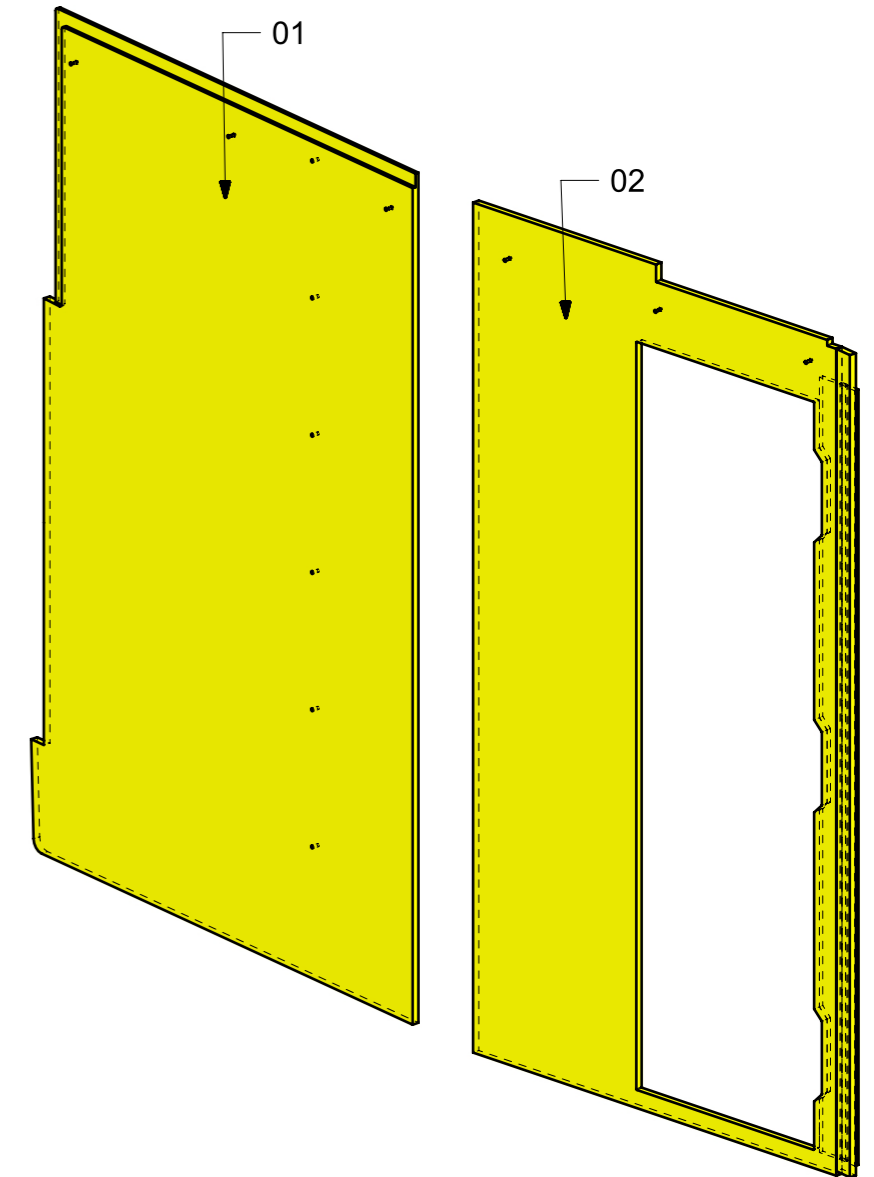

FERRAMENTA	QTY
BUSSOLA 6MA X 10 FORO DIAM.8	6

LOCALE	CODICE	DESCRIZIONE COMPONENTE	FINITURA	Q.TA
PARATIE	MD299_PR02	PR02 PARATIA BAGNO_CABINA OSPITI SX	OKUME' GREZZO	1

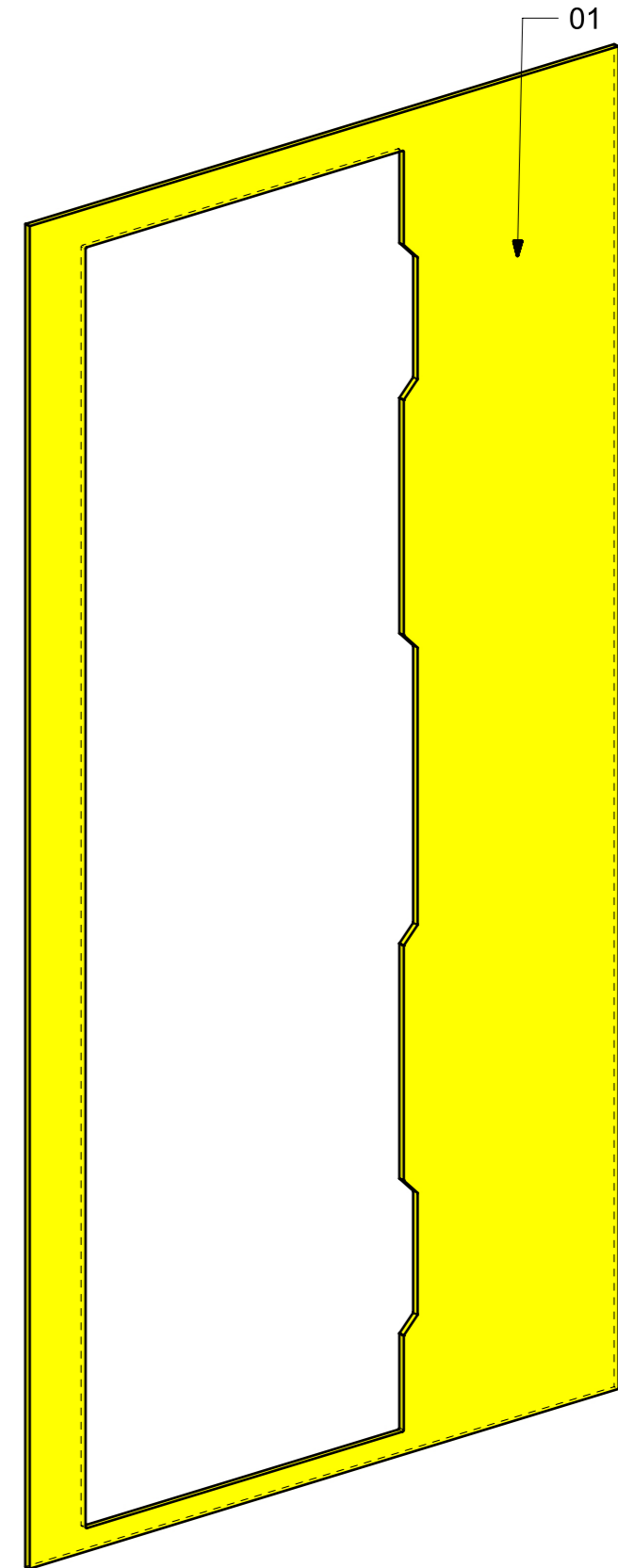
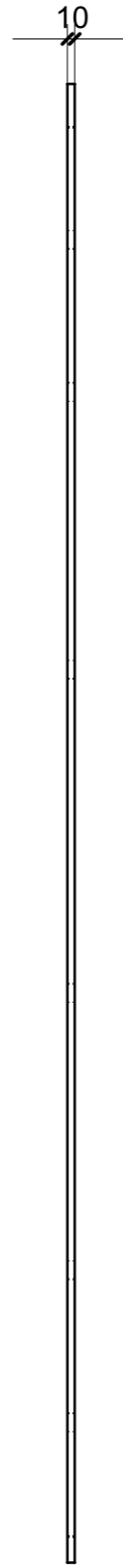
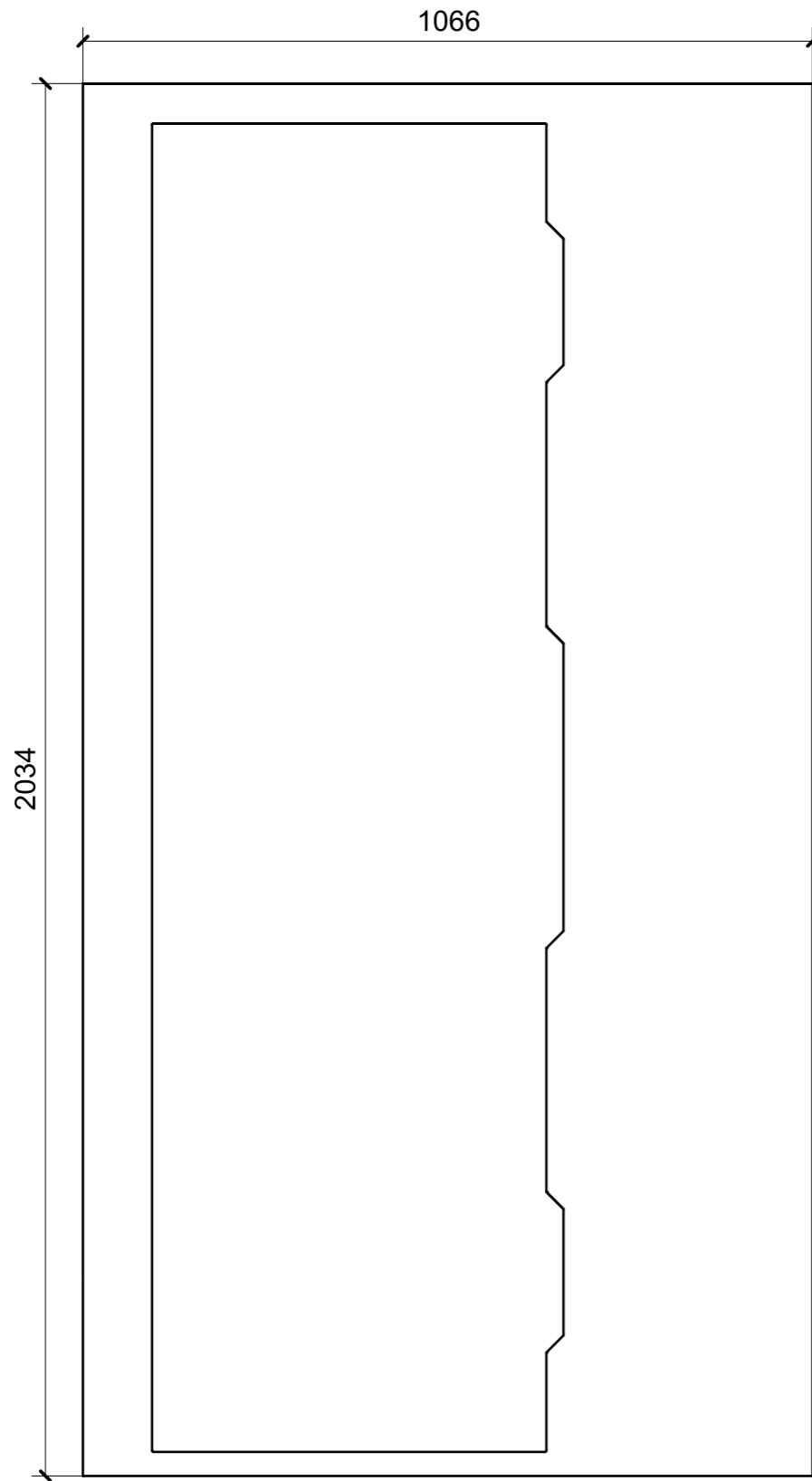

01

LOCALE	CODICE	PARATIA INGRESSO_CABINA VIP	FINITURA	Q.TA
PARATIE	MD299_PR03	PARATIA INGRESSO_CABINA VIP	OKUME' GREZZO	1

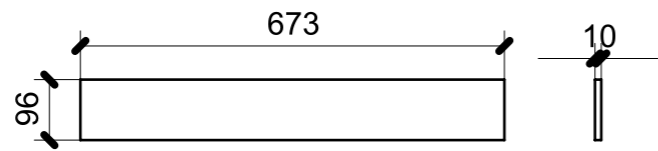

02

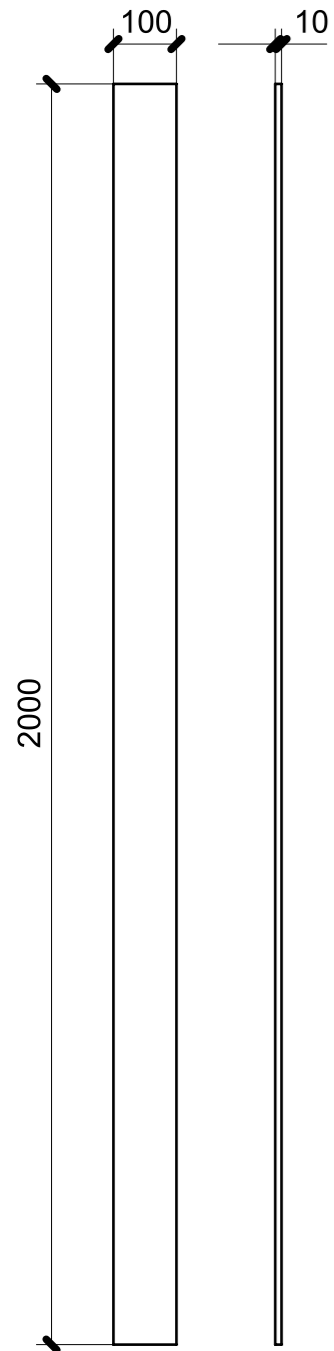

01

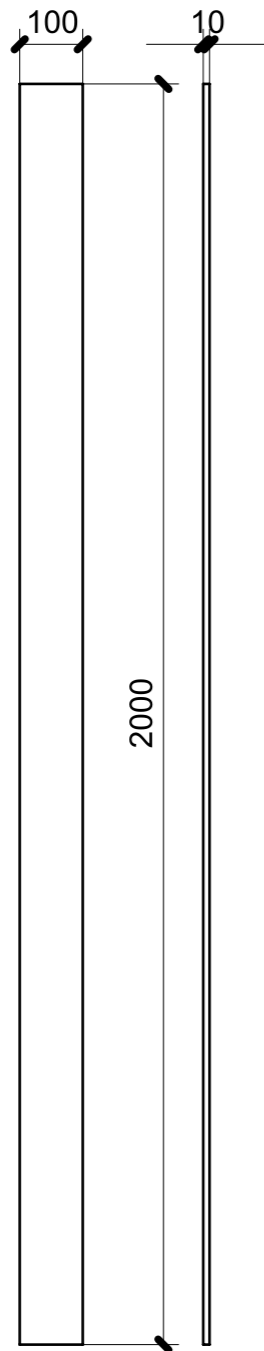

03

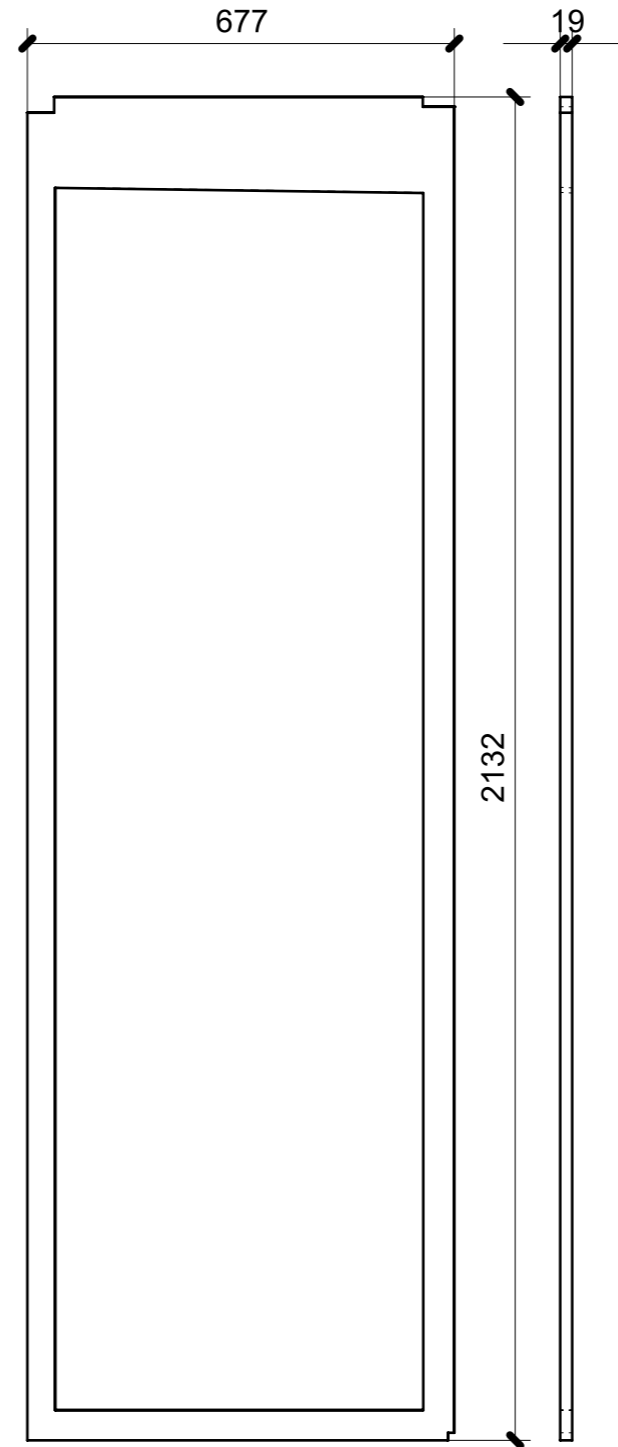

04

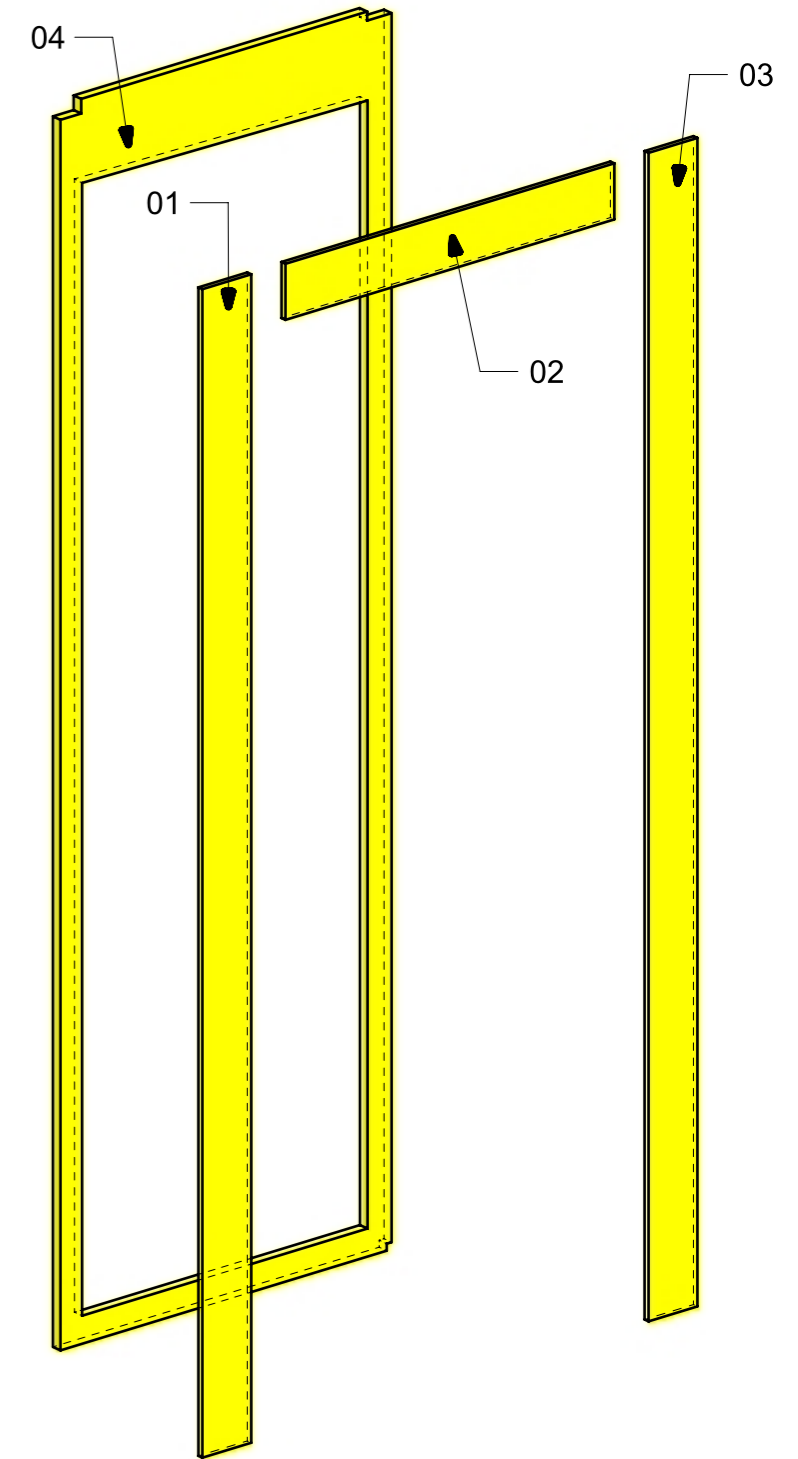

LOCALE	CODICE	DESCRIZIONE COMPONENTE	FINITURA	Q.TA
PARATIE	MD299_PR04	PARATIA INGRESSO BAGNO OSPITI SX DA CORRIDOIO	OKUME' GREZZO	1

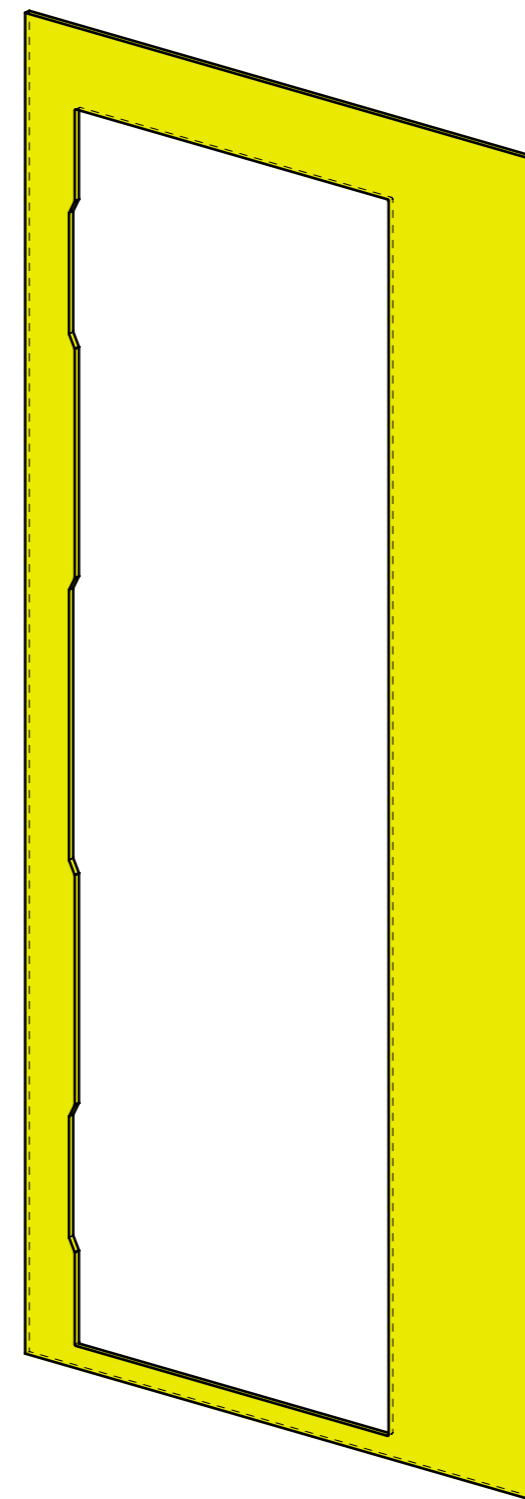
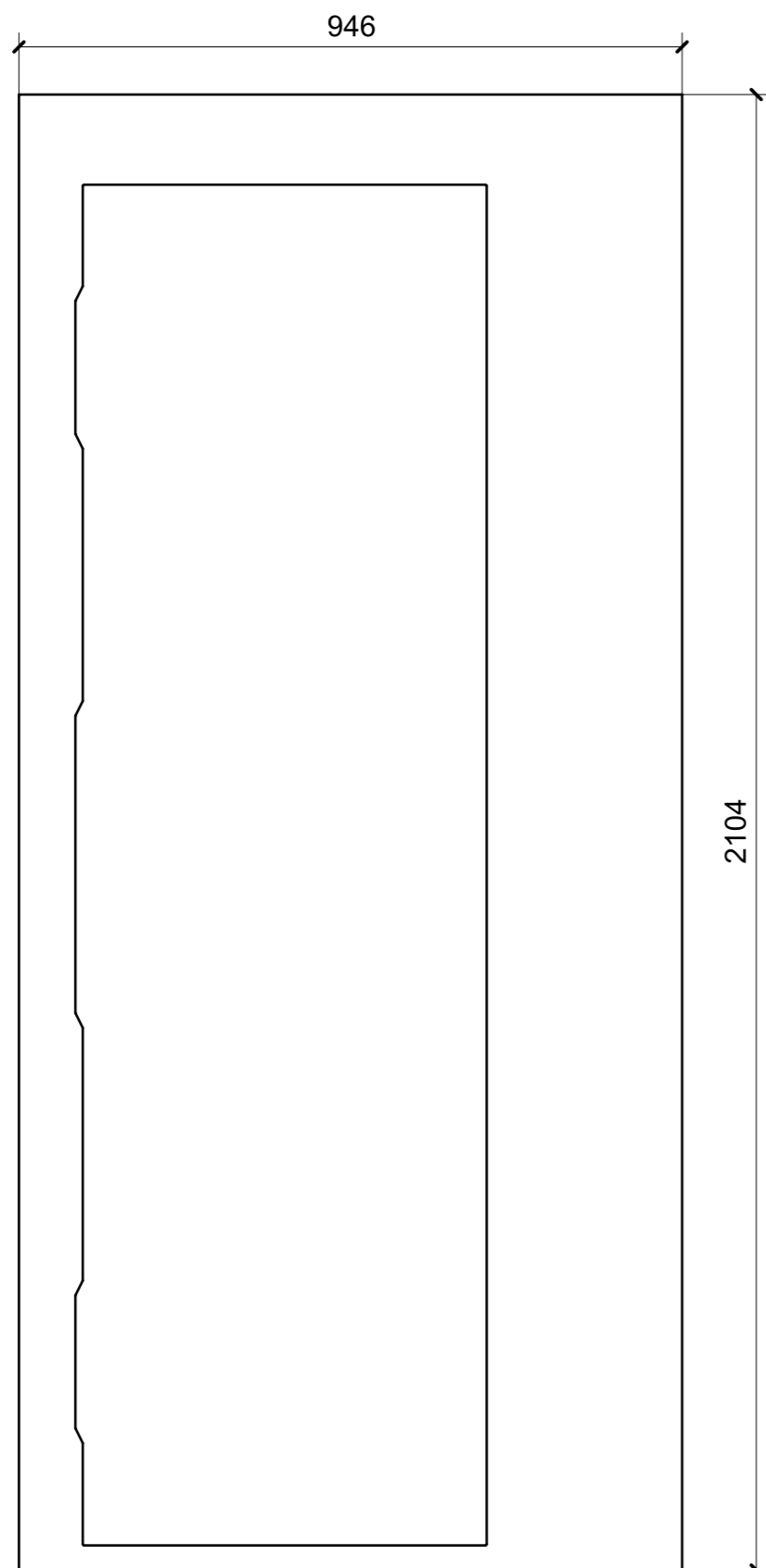

01

10

LOCALE	CODICE	DESCRIZIONE COMPONENTE	FINITURA	Q.TA
PARATIE	MD299_PR05	PARATIE CABINA OSPITI DX	OKUME' GREZZO	1

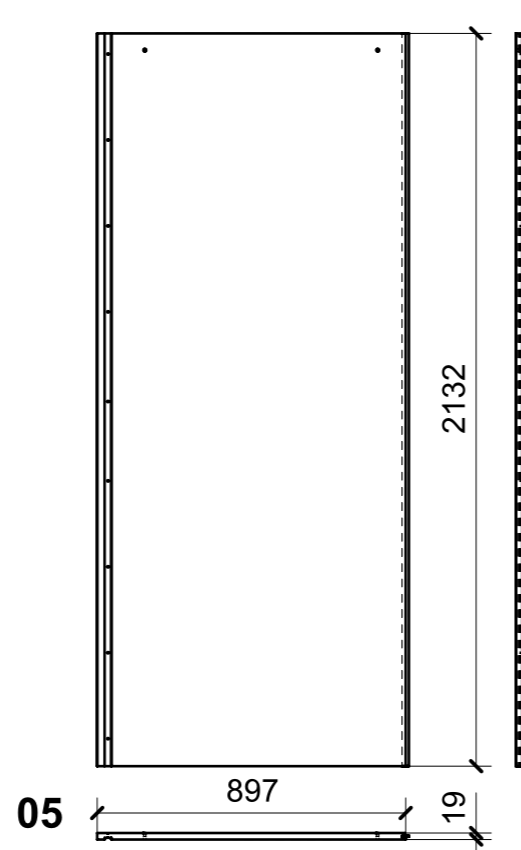
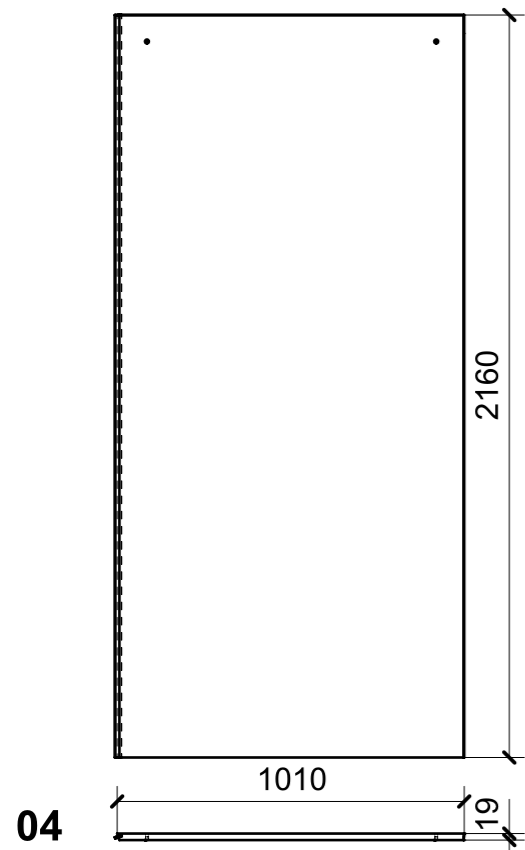
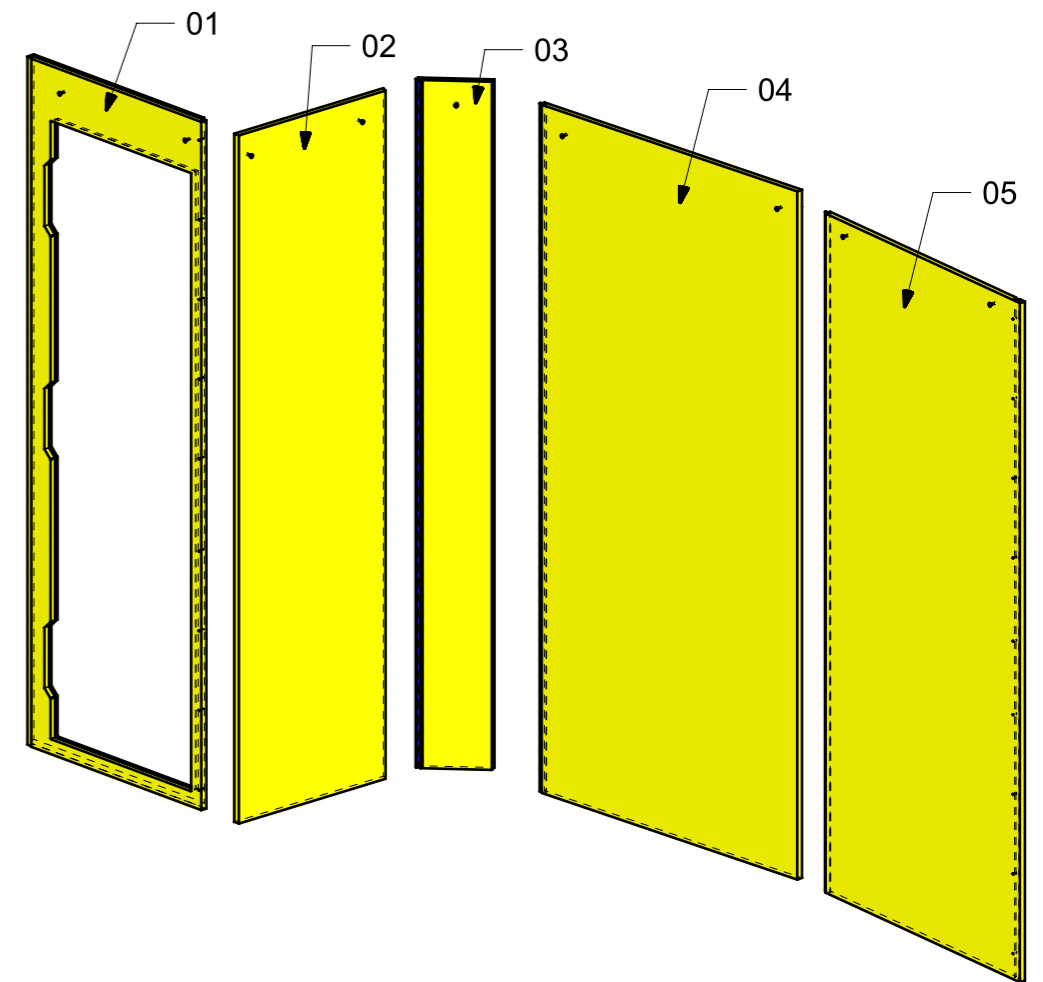
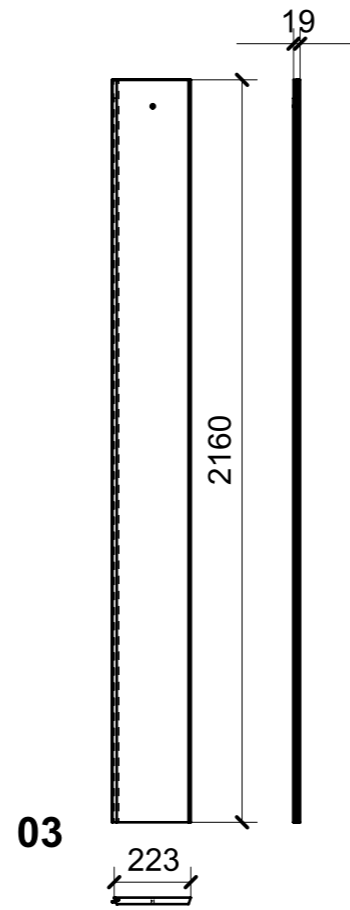
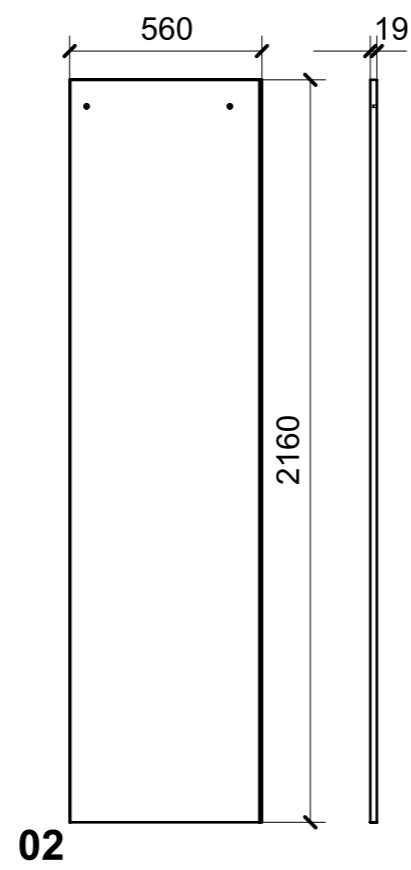
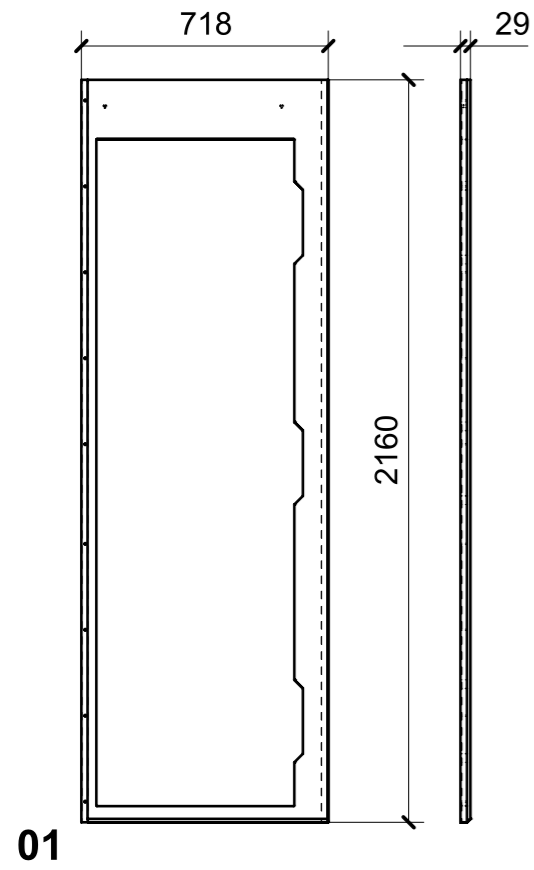

FERRAMENTA	QTY
BUSSOLA 6MA X 10 FORO DIAM.8	9

LOCALE	CODICE	DESCRIZIONE COMPONENTE	FINITURA	Q.TA
PARATIE	MD299_PR06	PARATIA CORRIDOIO ZONA INGRESSO ARMATORE	OKUME' GREZZO	1

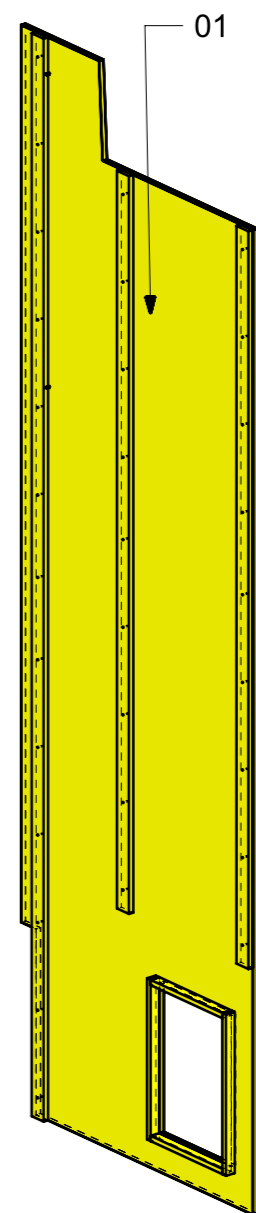
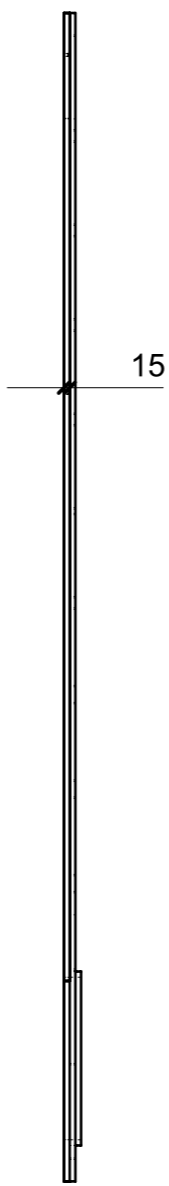
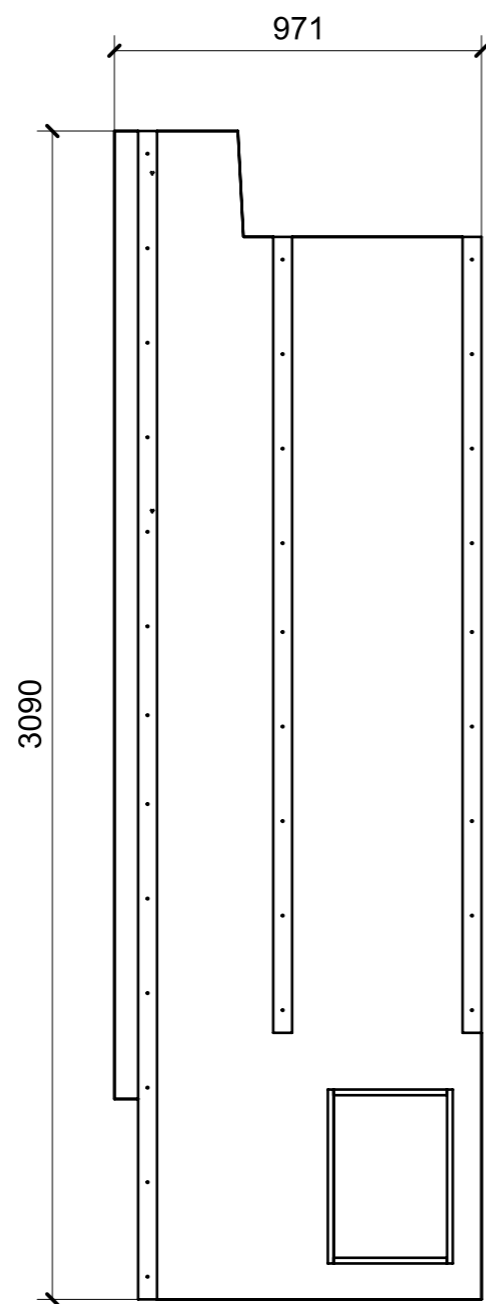

01

FERRAMENTA	QTY
BUSSOLA 6MA X 10 FORO DIAM.8	2

LOCALE	CODICE	DESCRIZIONE COMPONENTE	FINITURA	Q.TA
PARATIE	MD299_PR07	PARATIA BAGNO OSPITI DX	OKUME' GREZZO	1

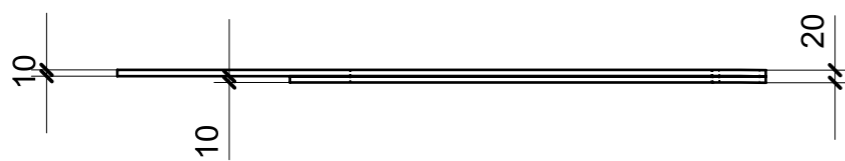
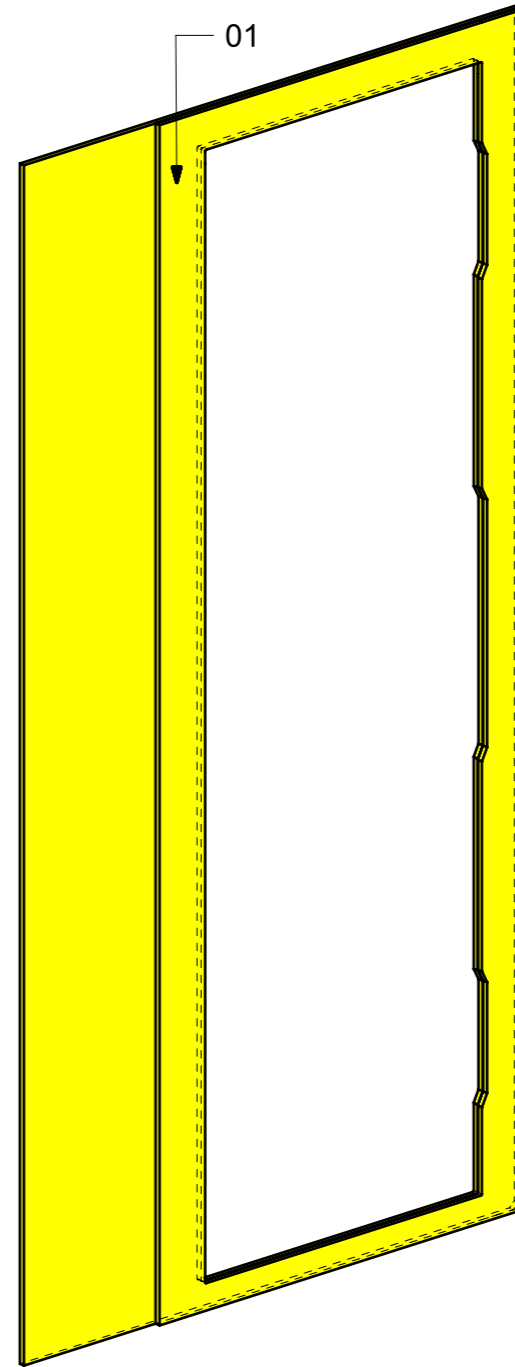
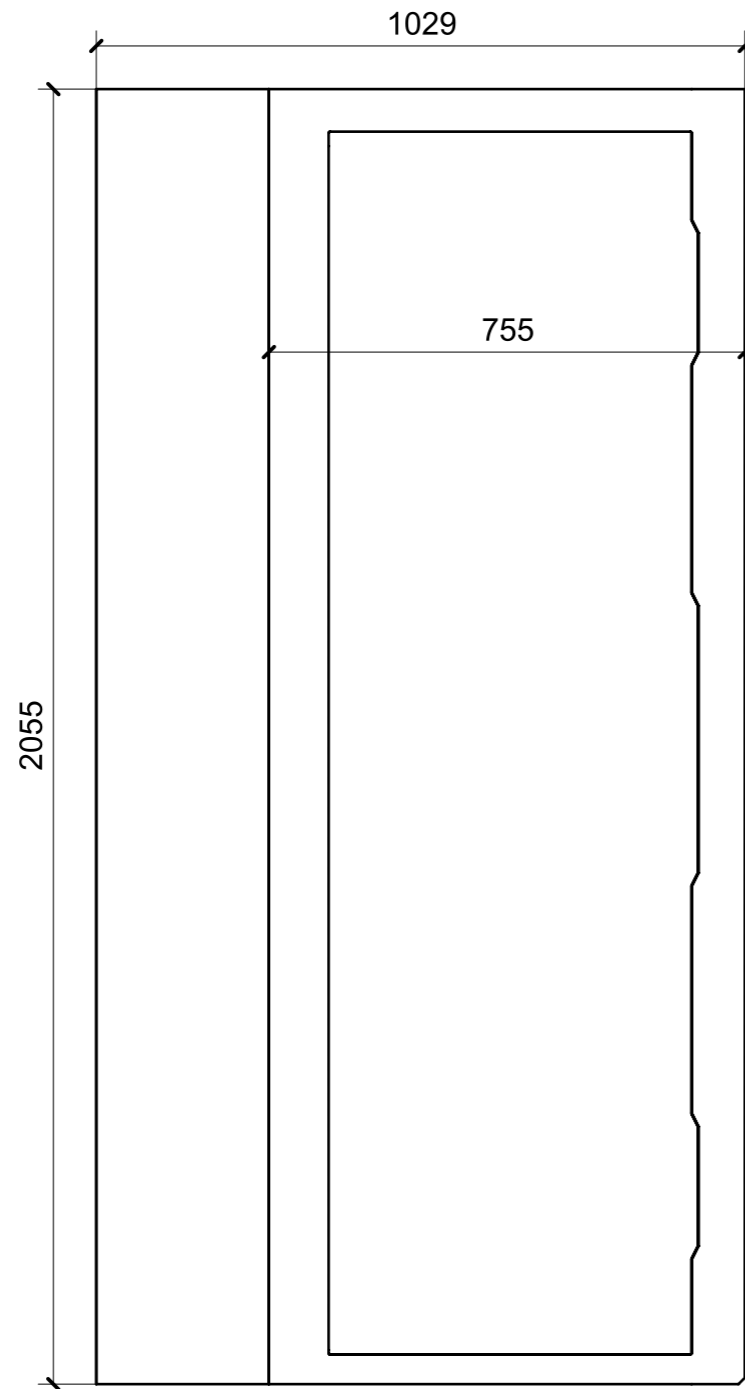

01

LOCALE	CODICE	DESCRIZIONE COMPONENTE	FINITURA	Q.TA
PARATIE	MD299_PR08	PARATIA DI GIUNZIONE FRONTEMARCIA	OKUME' GREZZO	1

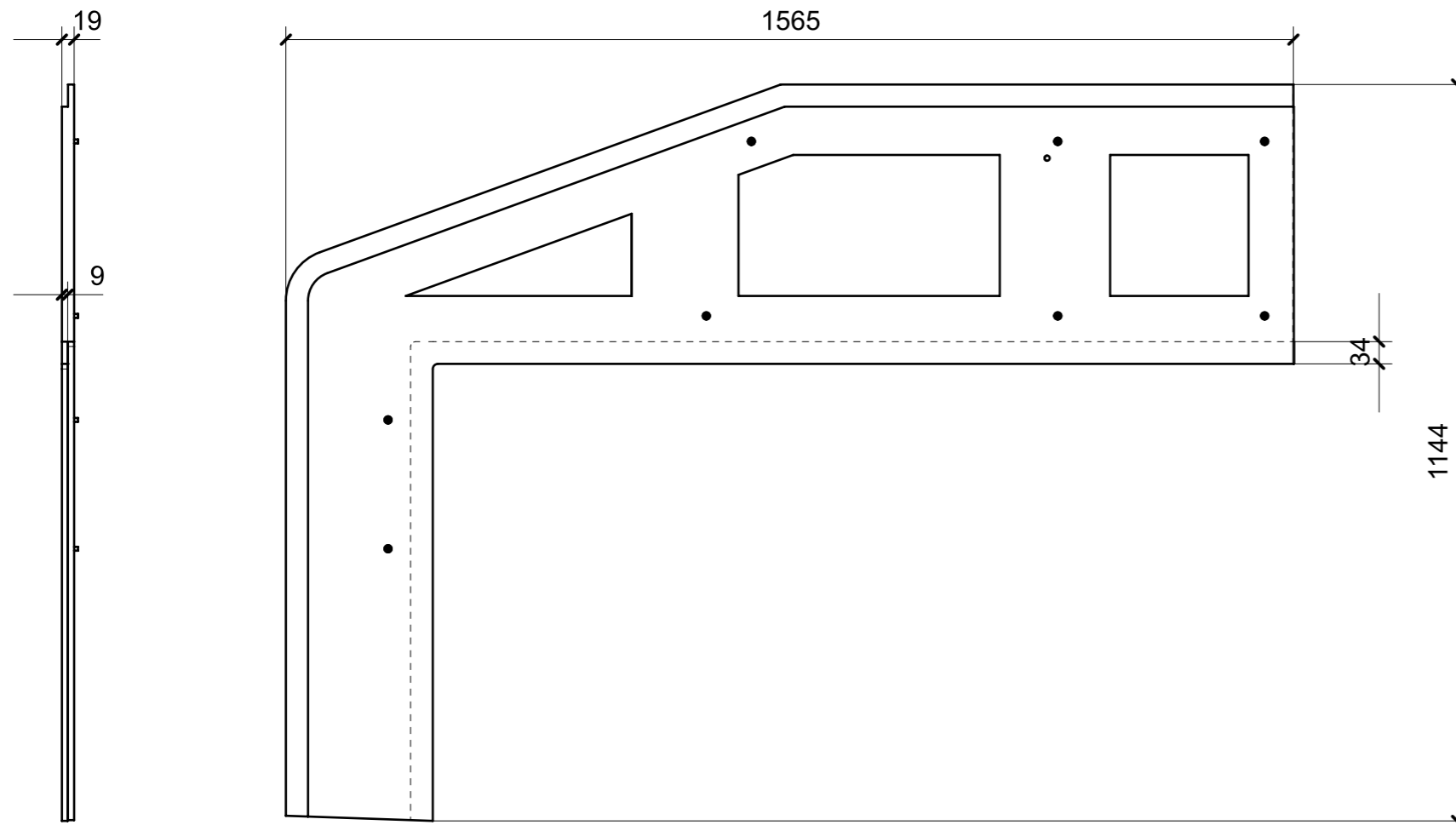

01

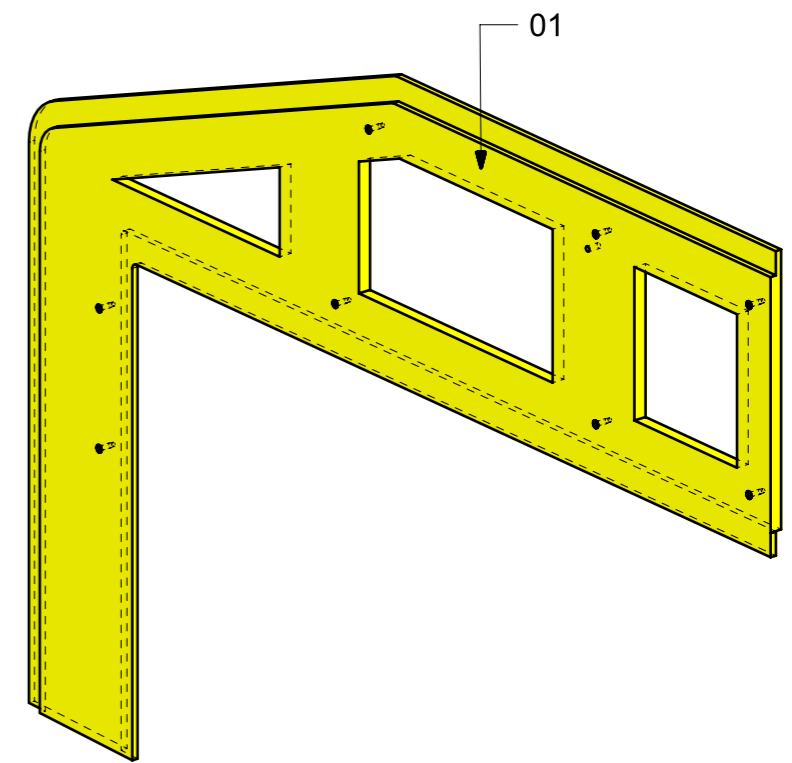

FERRAMENTA	QTY
VITE 6MA X 25 TESTA SVASATA	8