

LOCALE	CODICE	DESCRIZIONE COMPONENTE	FINITURA	Q.TA
BAGNO OSPITI SX	MD299_X01_YC01	COLLEGAMENTO BASSO	LAMINATO MAGNOLIA ANNAPURNA	1

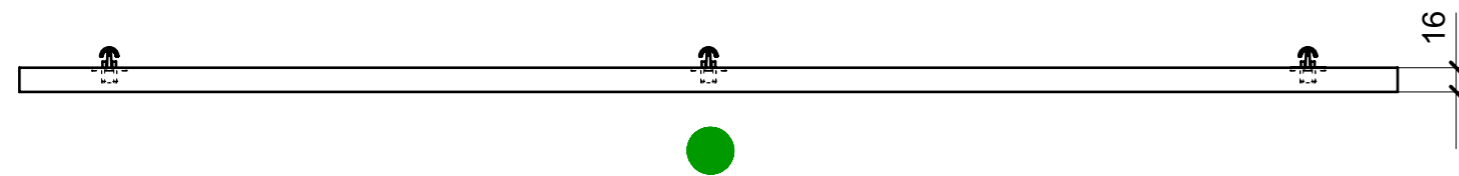

01

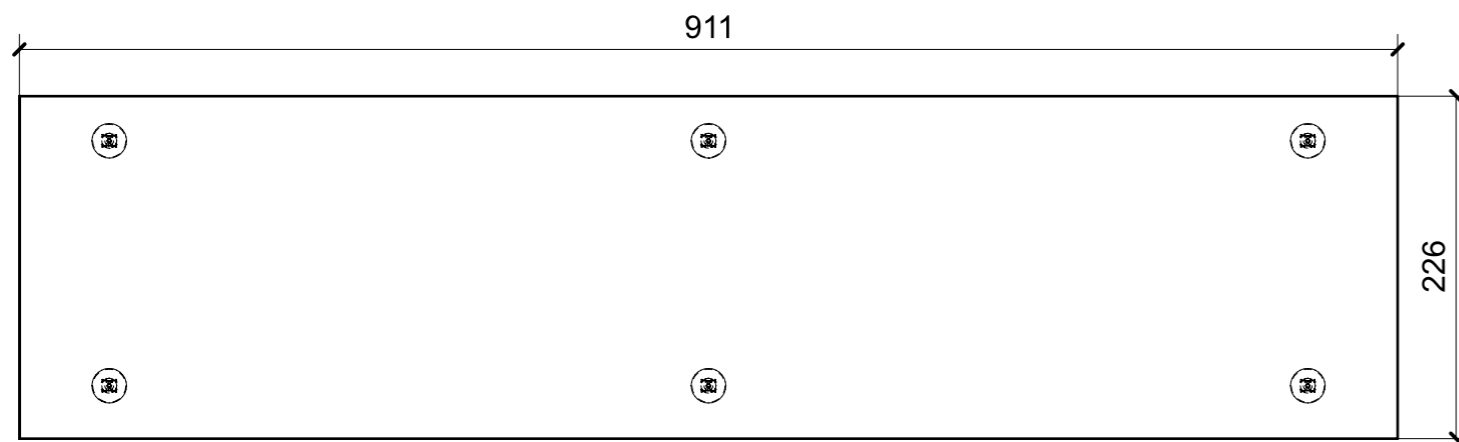
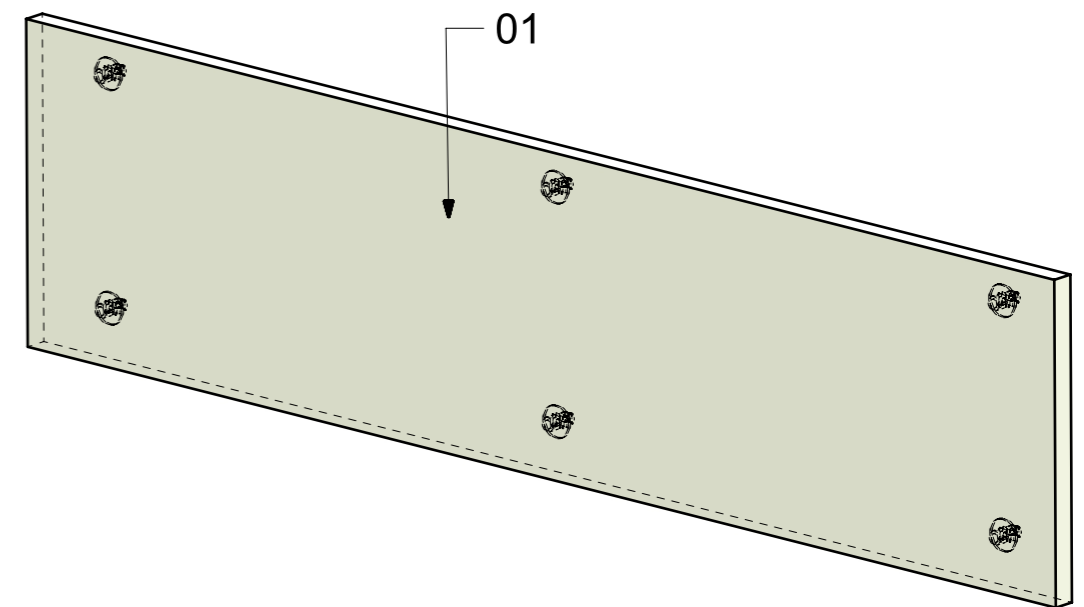

FERRAMENTA	QTY
MS INCASSO_ITALVIPLA_972_FMPC_M1B	6

LOCALE	CODICE	DESCRIZIONE COMPONENTE	FINITURA	Q.TA
BAGNO OSPITI SX	MD299_X01_YI01	PAVIMENTO BAGNO	LAMINATO MAGNOLIA ANNAPURNA	1

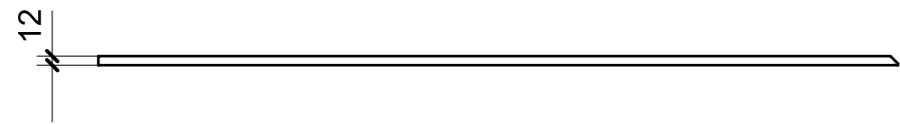
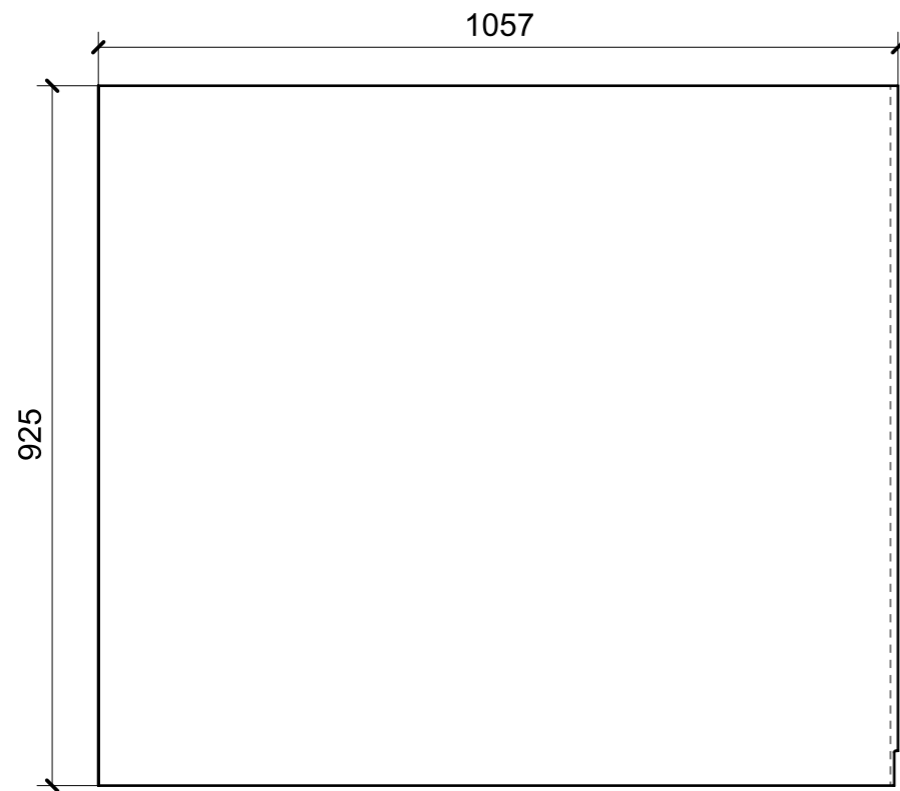

01

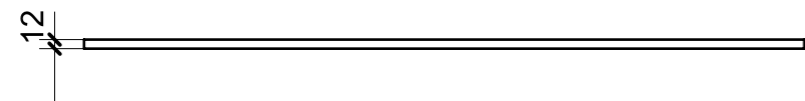
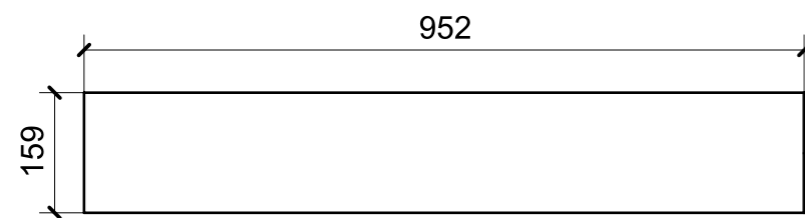

02

