

AZ68F

REV. 16-09-2022

LOCALE	CODICE	DESCRIZIONE COMPONENTE	FINITURA	Q.TA	OPERATORE
CUCINA	AZ68F_P01_KA01	CUCINA MURATA	FAGGIO	1	Damiano

1 - L 523 x H 506 x 61 mm

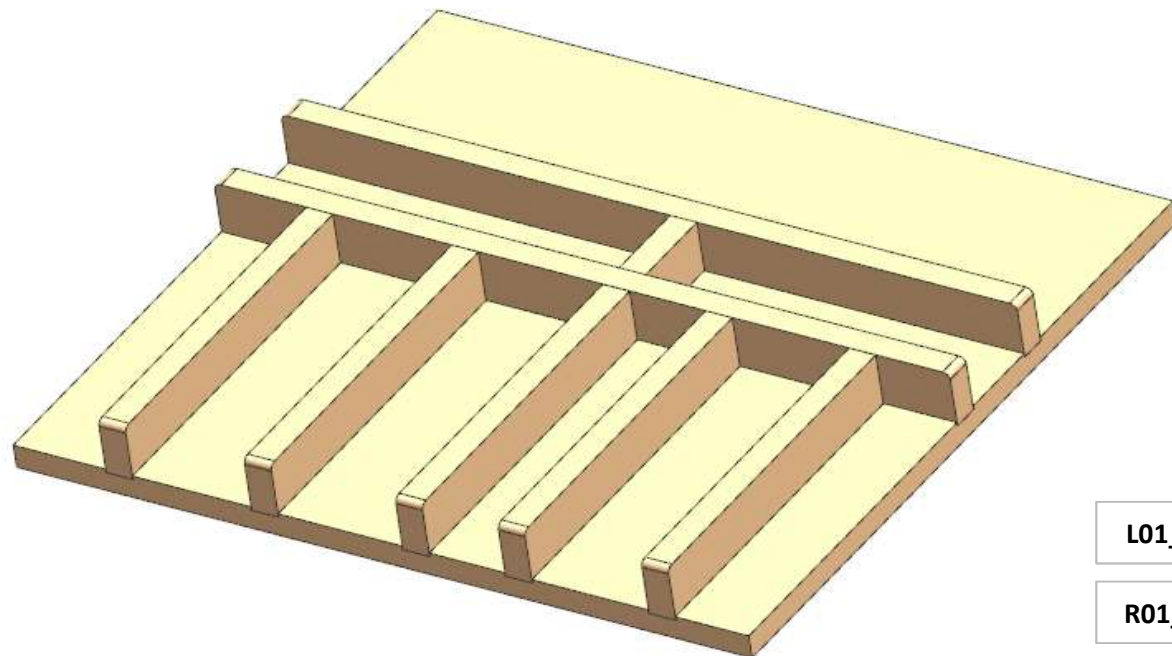

ELEMENTO DA MONTARE con:

L01_KA01

R01_KA01

R02_KA01

KA01

e spedire con un unico imballo

L01_KA01

R01_KA01

KA01

R02_KA01

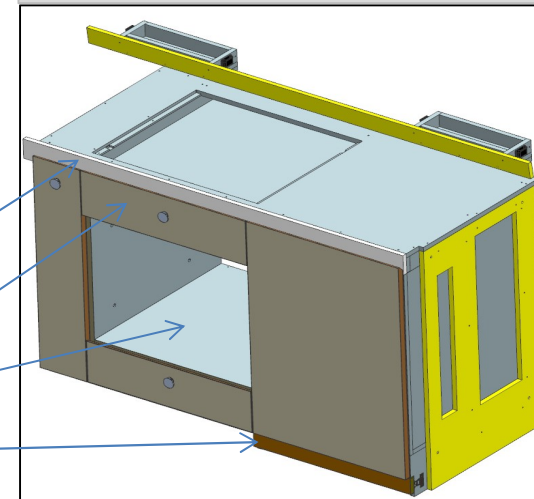

consonni&c

AZ68F

REV. 16-09-2022

LOCALE	CODICE	DESCRIZIONE COMPONENTE	FINITURA	Q.TA	OPERATORE
CUCINA	AZ68F-P01_KN01	FRIGO	FAGGIO\GOMMA	2	Damiano

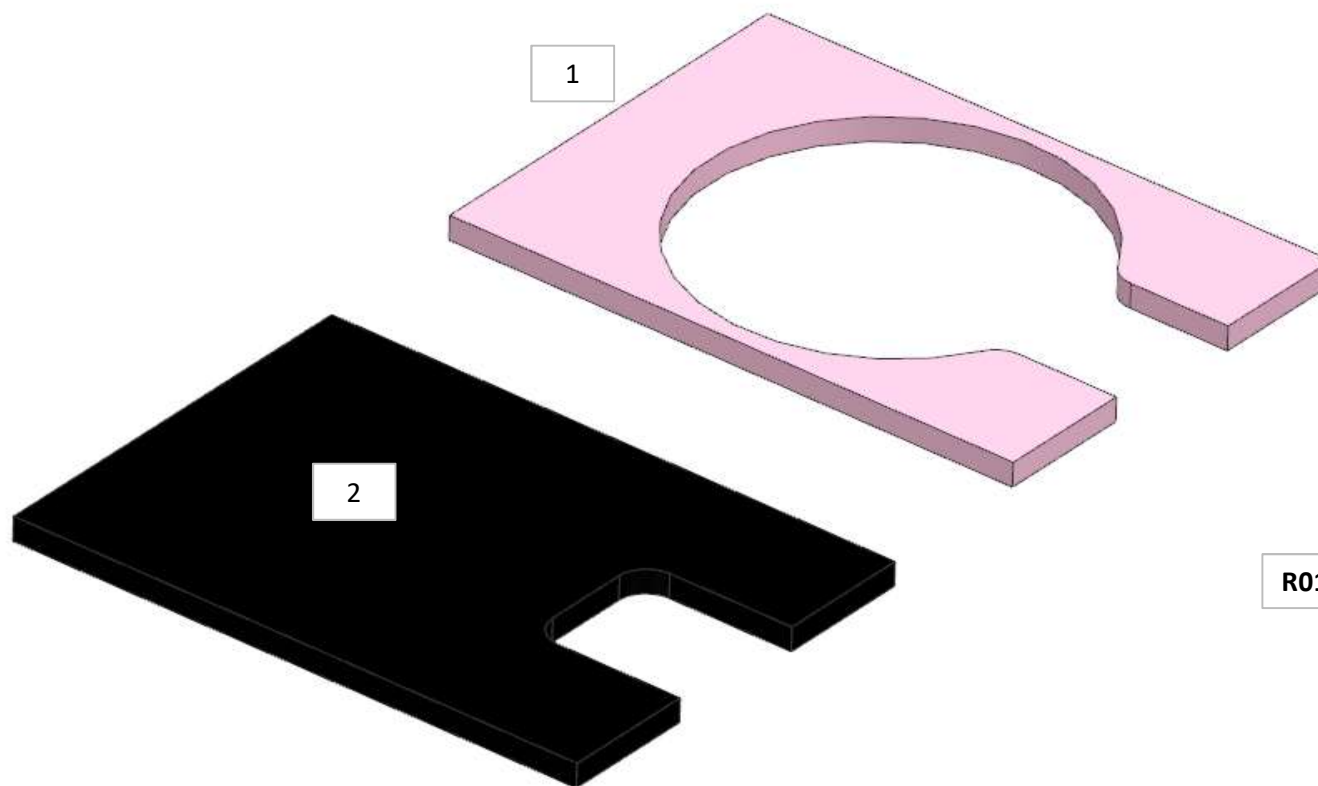

ELEMENTO DA MONTARE
con:
KN01
R01_KN01
e spedire con un unico
imballo

R01_KN01

KN01

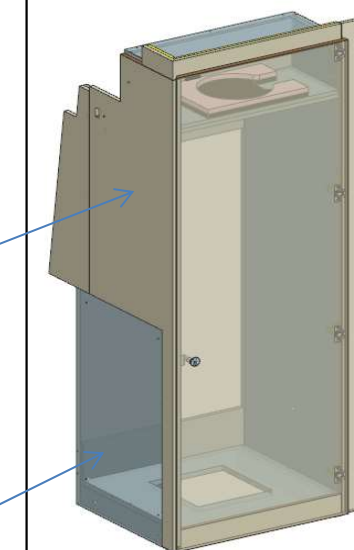

consonni&c

AZ68F

REV. 16-09-2022

LOCALE	CODICE	DESCRIZIONE COMPONENTE	FINITURA	Q.TA	OPERATORE
CUCINA	AZ68F-P01_KP01	DIVISORIO LANTERNA-OPT	PLEXIGLASS	1	Damiano

1 - L 756 x H 1533 x 304.5 mm

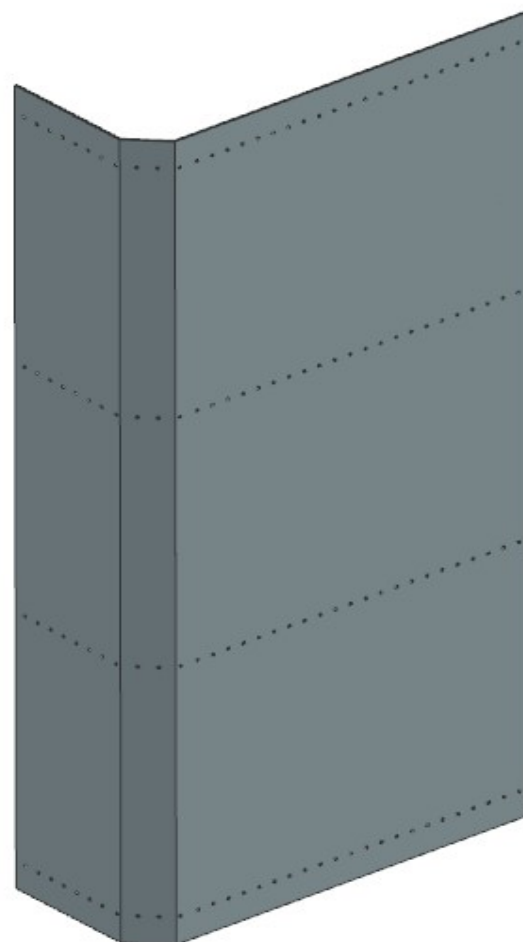

ELEMENTO DA
MONTARE con:
R01_KP01
L01_KP01
L02_KP01
A01_KP01
e spedire con un unico
imballo

L01_KP01

R01_KP01

A01_KP01

L02_KP01

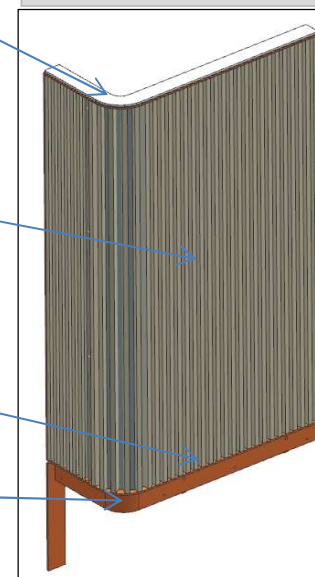

consonni&c

AZ68F

DA MAT. 201 REV. 16-09-2022

LOCALE	CODICE	DESCRIZIONE COMPONENTE	FINITURA	Q.TA	OPERATORE
CUCINA	AZ68F-P01_KU01	PLEXIGLAS	PLEXIGLASS	1	Damiano

1 - L 893 x H 428 x sp 4

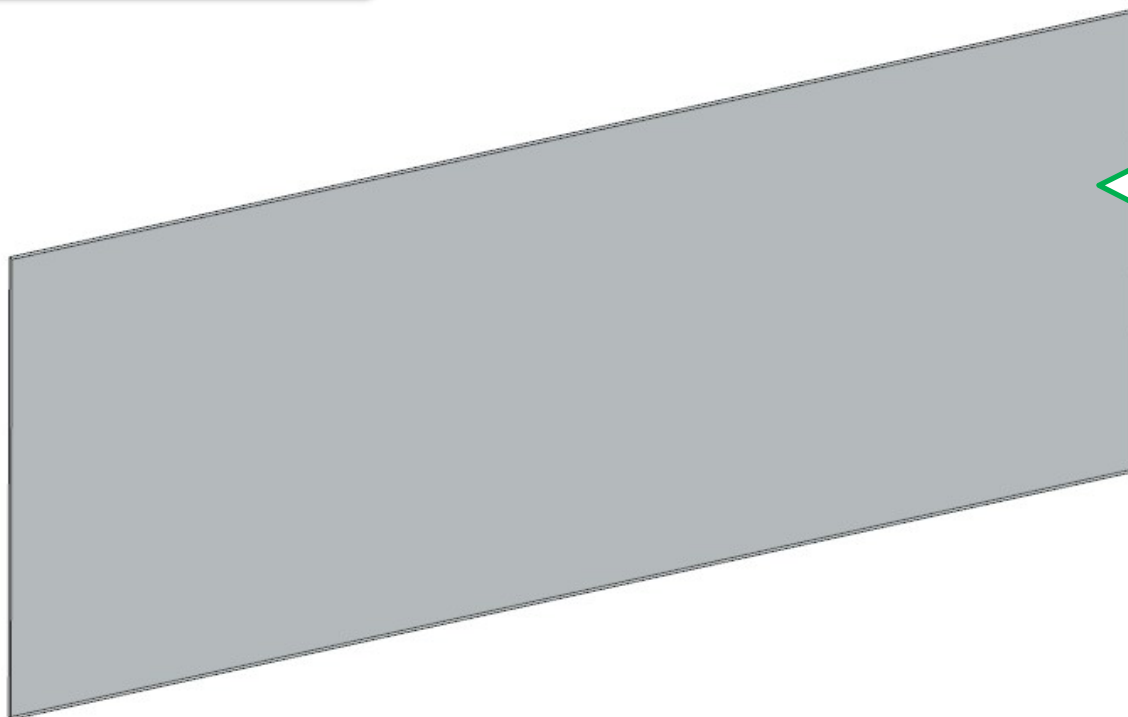

NB:
DA CONSEGNARE SEMPRE
QUANDO C'è VERSIONE
CUCINA A PRUA (SIA
APERTA CHE CHIUSA)