

AZ68F

DA MAT 265

REV. 29-04-2024

LOCALE	CODICE	DESCRIZIONE COMPONENTE	FINITURA	Q.TA	OPERATORE
CABINA ARMATORE	AZ68F-I01_AB01	STRUTTURA TV A MURATA SX	OKOUME' GREZZO	1	Dante

1 - L.2070 x H.698 x sp 19

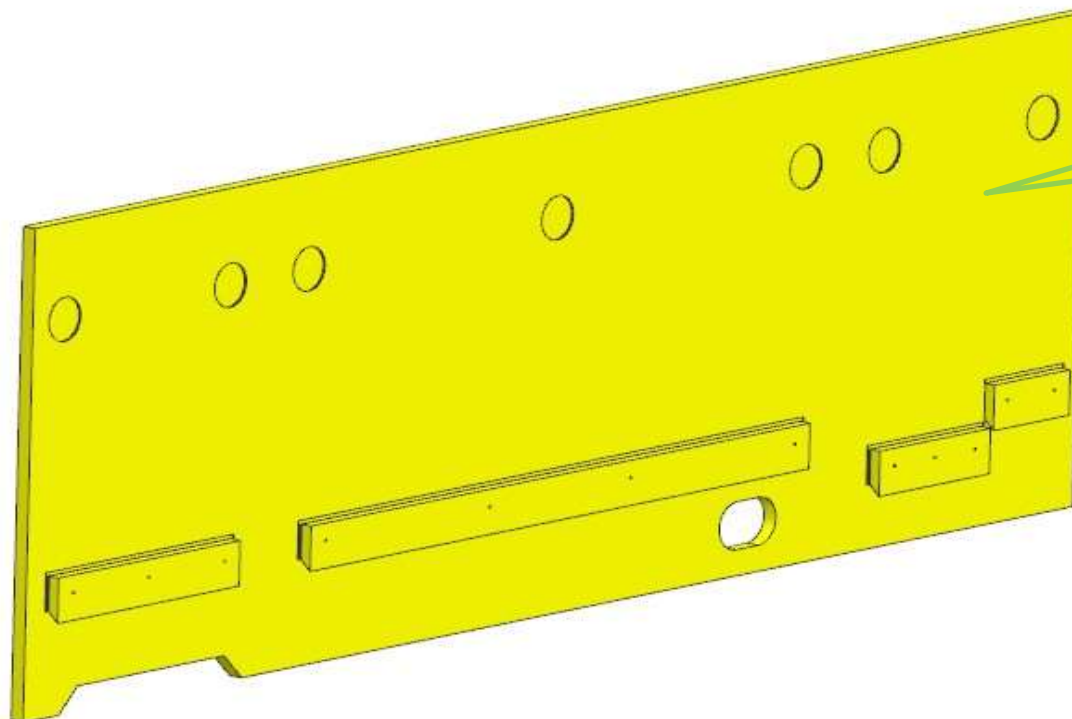

ELIMINATI RIBASSI

AZ68F

DA MAT 237

REV. 29-04-2024

LOCALE	CODICE	DESCRIZIONE COMPONENTE	FINITURA	Q.TA	OPERATORE
CABINA ARMATORE	AZ68F-I01_AF01	RIVESTIMENTO POPPA SX	OKOUME' GREZZO	1	Dante

1 - L 506 (SVILUPPO) x H744 x sp 19

ELIMINATO RIBASSO

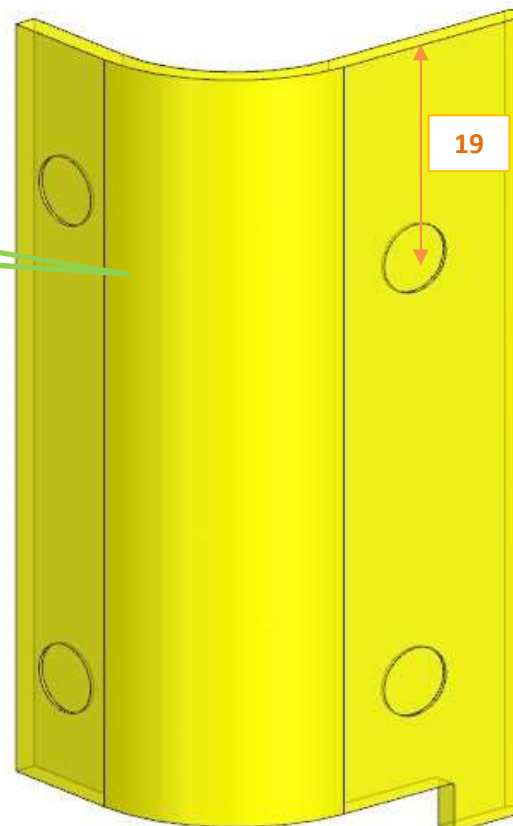

AZ68F

DA MAT 237

REV. 29-04-2024

LOCALE	CODICE	DESCRIZIONE COMPONENTE	FINITURA	Q.TA	OPERATORE
CABINA ARMATORE	AZ68F-I01_AG01	RIVESTIMENTO PRUA SX	OKOUME' GREZZO	1	Dante

1 - L 506 (SVILUPPO) x H744 x sp 19

ELIMINATO RIBASSO

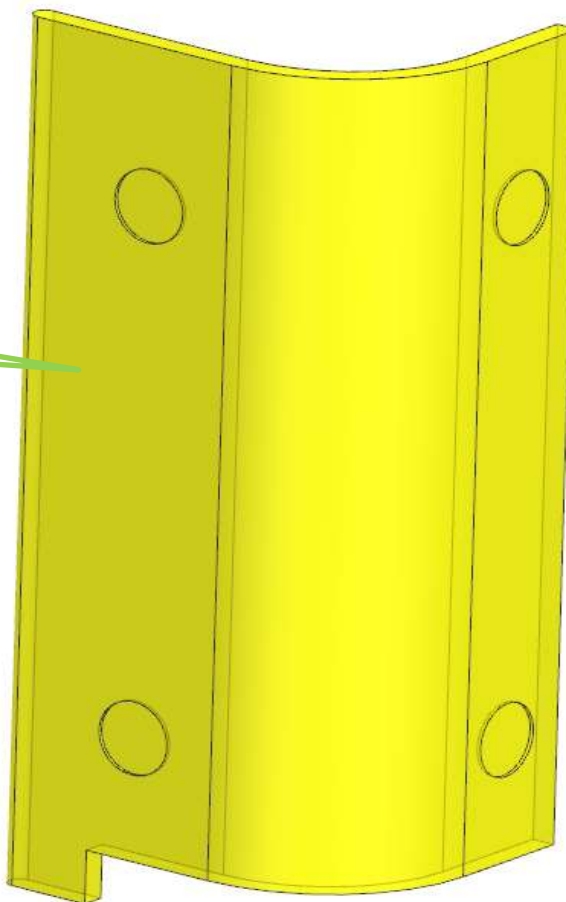

AZ68F

DA MAT. 265

REV. 29-04-2024

LOCALE	CODICE	DESCRIZIONE COMPONENTE	FINITURA	Q.TA	OPERATORE
CABINA ARMATORE	AZ68F-I01_AL01	ARMADIO DX POPPA	OKOUME' GREZZO	7	Damiano\Dante

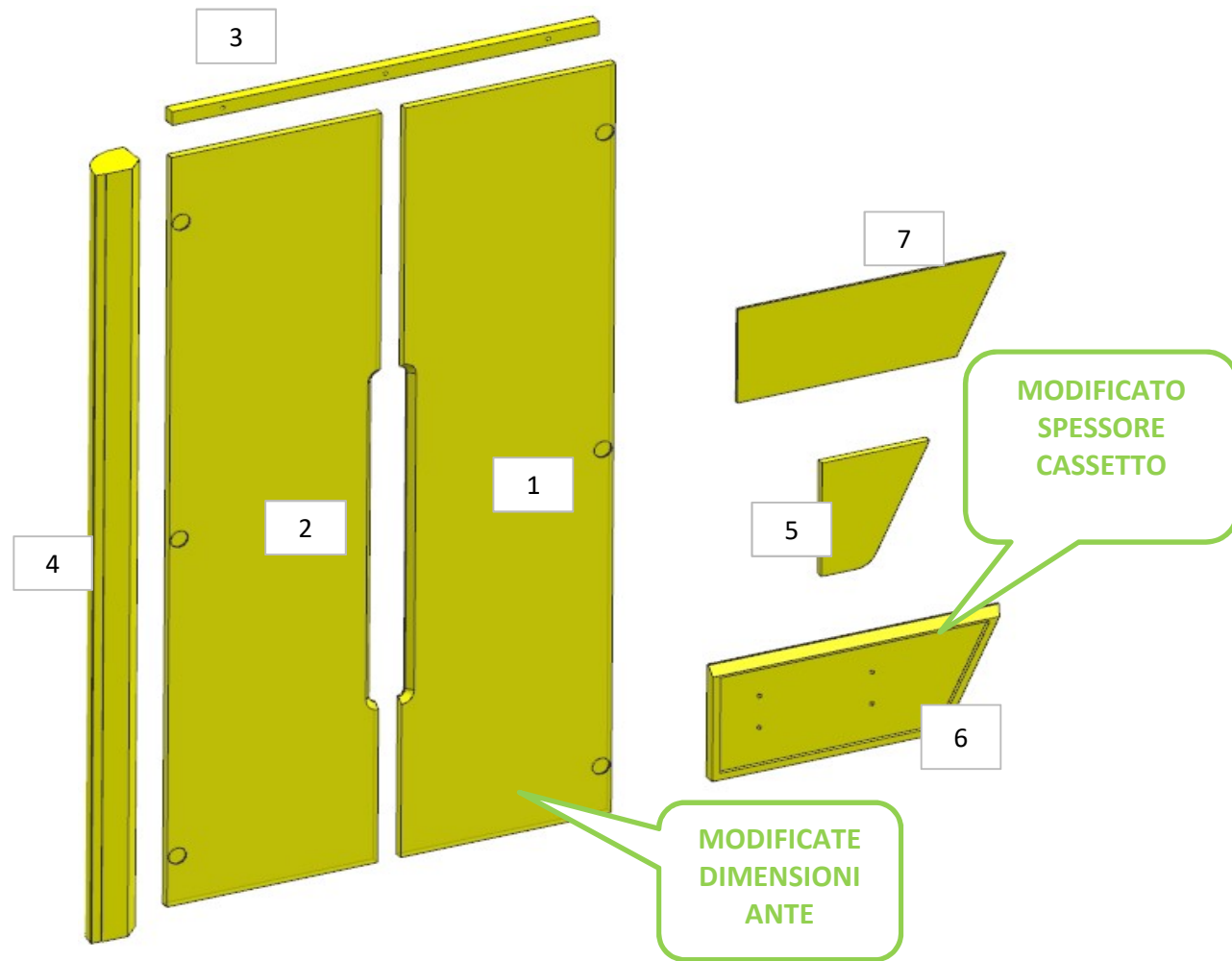

- 1 - 2 - L 422 x H 1662 x sp 17
- 3 - L 847 x H 30 x sp 25
- 4 - H. 1699
- 5 - L 213 x H 251 x sp 15
- 6 - L 577 x H 249 x sp 25
- 7 - L 530 x H 207 x sp 6

COMPONENTI 1 E 2 DA MONTARE con:
A01_AL01_01 E A01_AL01_02
 e spedire con un unico imballo

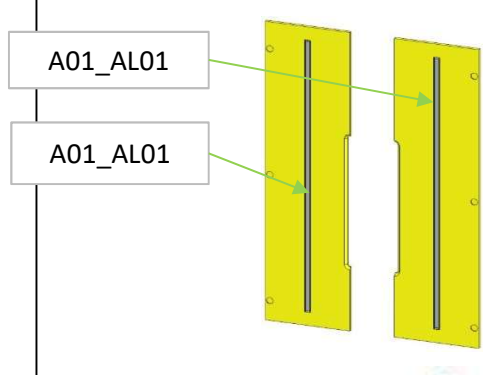

AZ68F

DA MAT. 237

REV. 29-04-2024

LOCALE	CODICE	DESCRIZIONE COMPONENTE	FINITURA	Q.TA	OPERATORE
CABINA ARMATORE	AZ68F-I01_AM01	STRUTTURA DX ANGOLO POPPA	OKOUME' GREZZO	1	Dante

1 - SVILUPPO 1071 x H 707 x sp 19

142
SPEDIRE
PEZZO UNICO

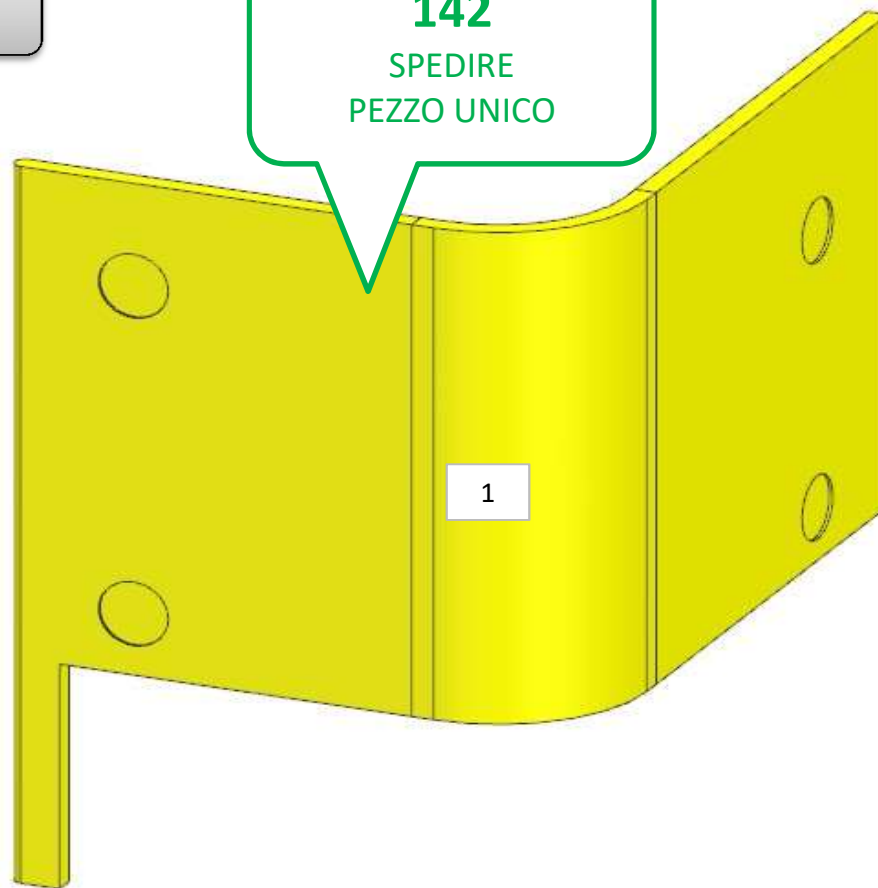

AZ68F

DA MAT. 237

REV. 29-04-2024

LOCALE	CODICE	DESCRIZIONE COMPONENTE	FINITURA	Q.TA	OPERATORE
CABINA ARMATORE	AZ68F-I01_AO01	STRUTTURA BASSA A MURATA DX	OKOUME' GREZZO	1	Dante

1 - L 2140 x H485 x sp 19

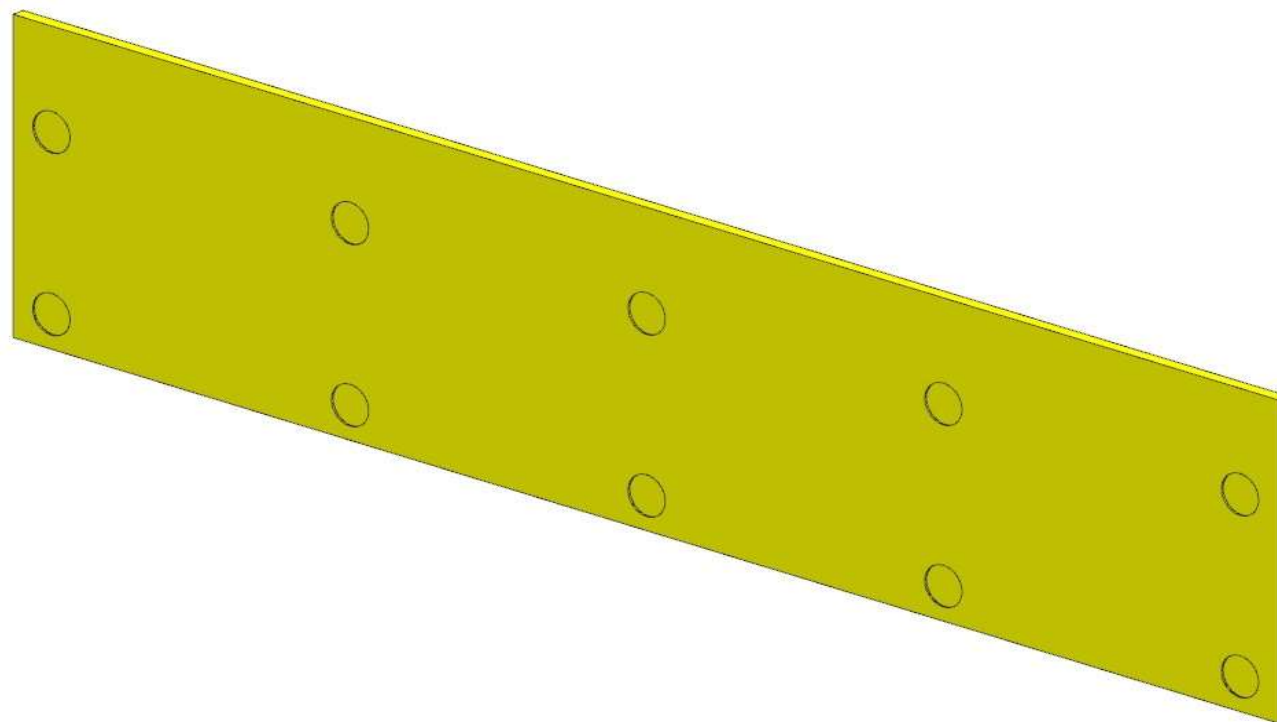

consonni&c

AZ68F

DA MAT. 237 REV. 29-04-2024

LOCALE	CODICE	DESCRIZIONE COMPONENTE	FINITURA	Q.TA	OPERATORE
CABINA ARMATORE	AZ68F-I01_AP01	STRUTTURA DX ANGOLO PRUA	OKOUME' GREZZO	2	Dante/Damiano

1 - SVILUPPO 912 x H.707 x sp 19
2 - L 1110 x H 1952 x sp 16

142
SPEDIRE
PEZZO UNICO

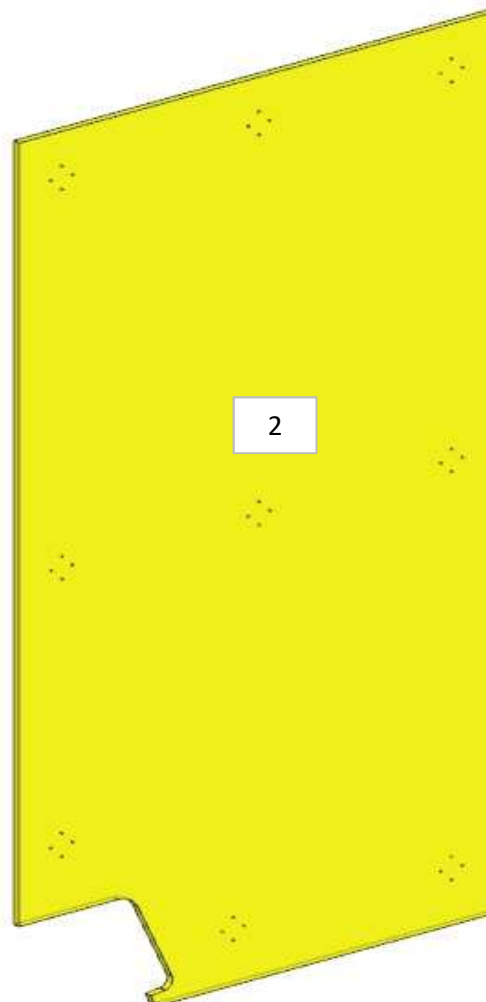
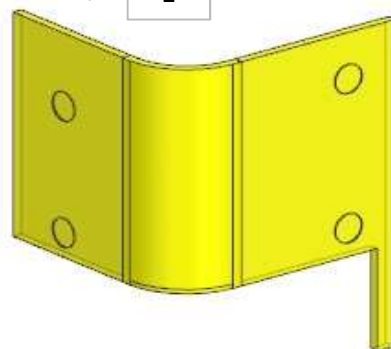

AZ68F

DA MAT. 233

REV. 29-04-2024

LOCALE	CODICE	DESCRIZIONE COMPONENTE	FINITURA	Q.TA	OPERATORE
CABINA ARMATORE	AZ68F-I01__AQ01	LETTO	OKOUME' GREZZO	3	Dante

1 - 3 - L.1428 x H.185 x sp 15mm
2 - SVILUPPO L.1694 x H.185 x sp 13mm

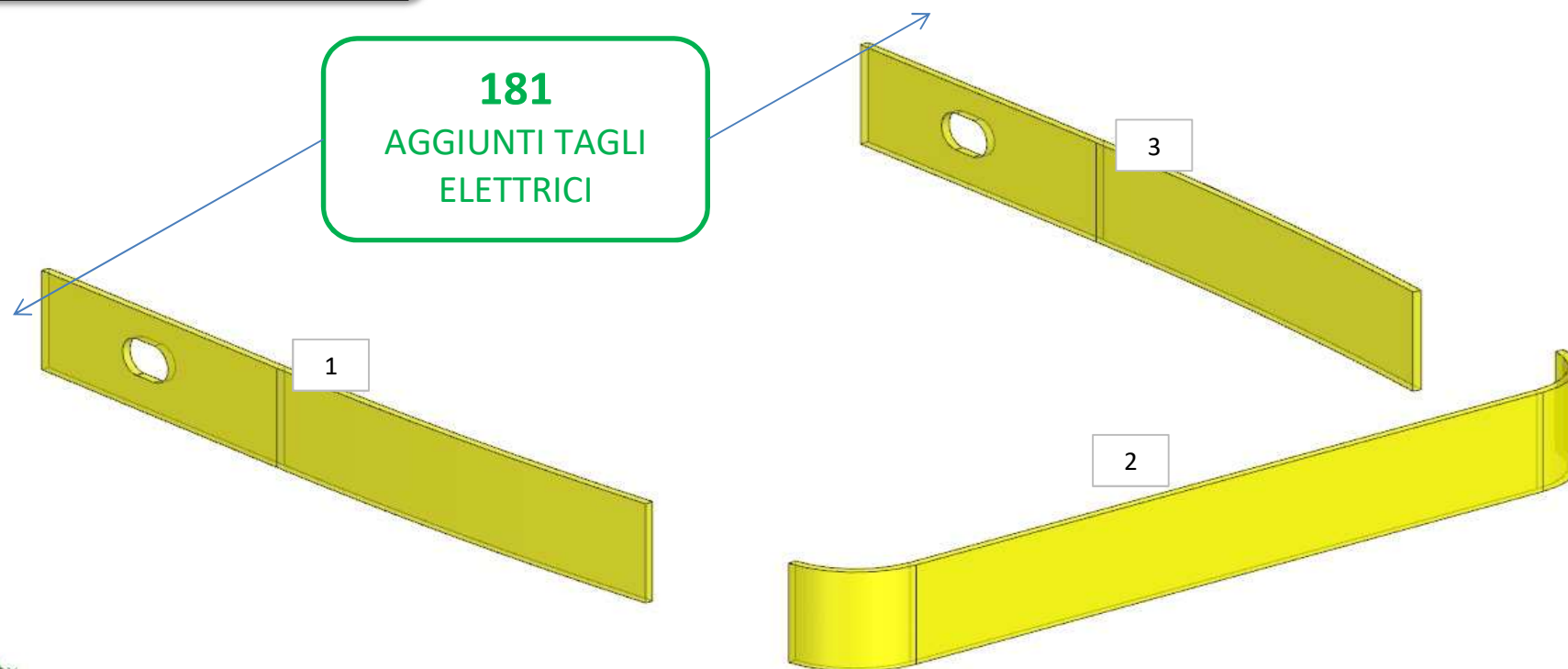

AZ68F

DA MAT. 203

REV. 29-04-2024

LOCALE	CODICE	DESCRIZIONE COMPONENTE	FINITURA	Q.TA	OPERATORE
CABINA ARMATORE	AZ68F-I01_AR01	COMODINO POPPA	OKOUME' GREZZO	1	Dante

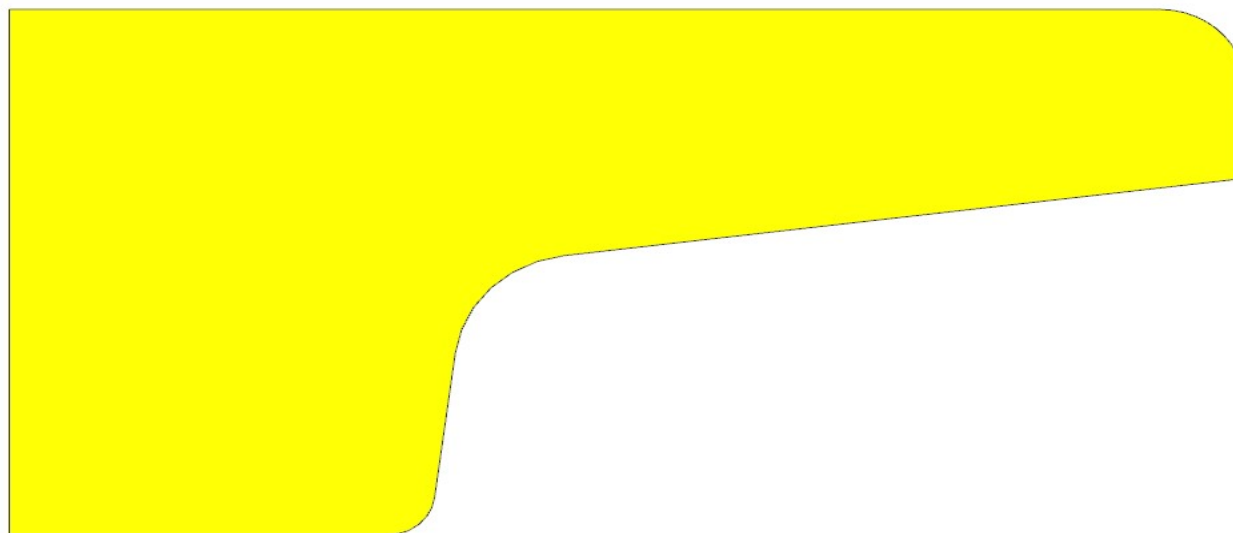

1 - L.1001 x H.472 x sp 10

AZ68F

DA MAT. 203

REV. 29-04-2024

LOCALE	CODICE	DESCRIZIONE COMPONENTE	FINITURA	Q.TA	OPERATORE
CABINA ARMATORE	AZ68F-I01_AS01	COMODINO PRUA	OKOUME' GREZZO	1	Dante

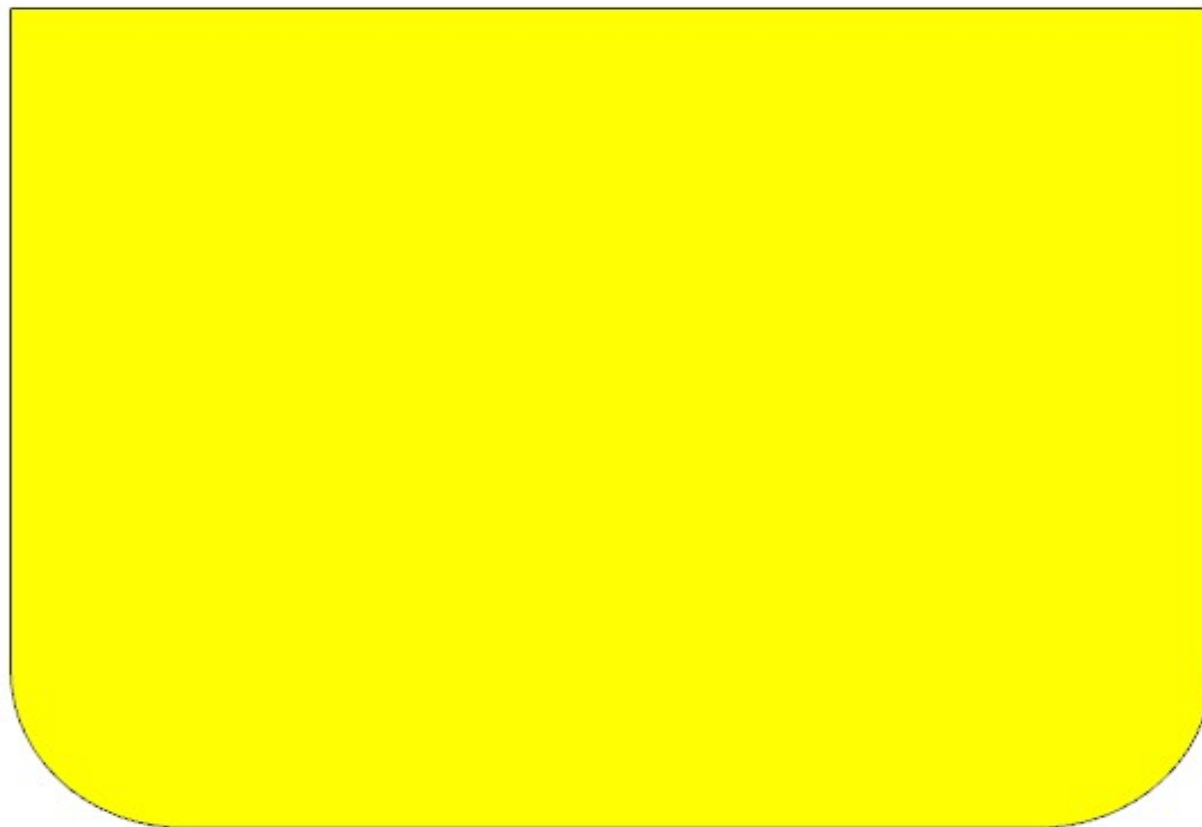

1 - L.472 x H 357 x sp 10

AZ68F

REV. 29-04-2024

LOCALE	CODICE	DESCRIZIONE COMPONENTE	FINITURA	Q.TA	OPERATORE
CABINA ARMATORE	AZ68F-I01_AT01	ARMADIO PRUA	OKOUME' GREZZO	3	Dante

1 - L.600 x H 30 x sp 25
 2 - 3 - L.298 x H 1915 x sp 17

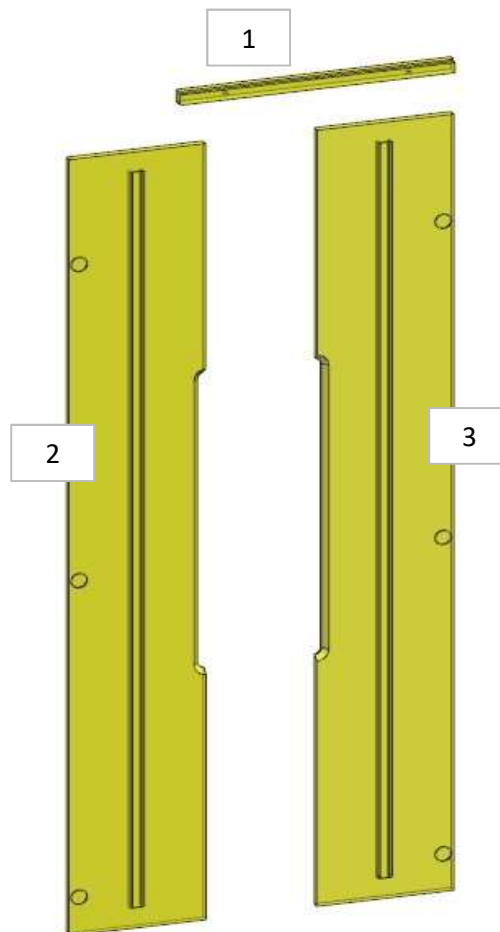
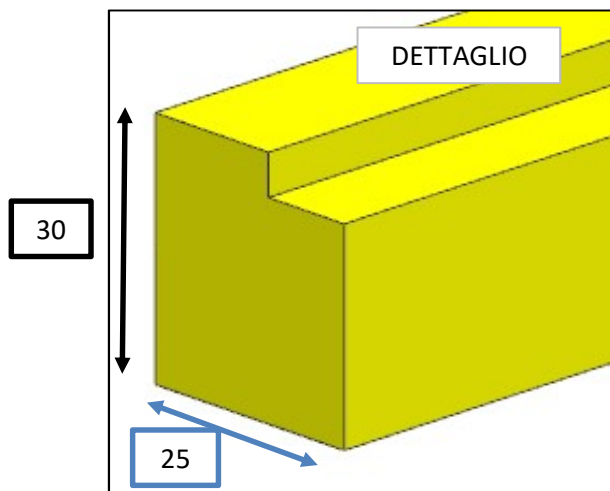

ELEMENTO 02 DA MONTARE con:
 A01_AT01_01
ELEMENTO 03 DA MONTARE con:
 A01_AT01_02
 e spedire con un unico imballo

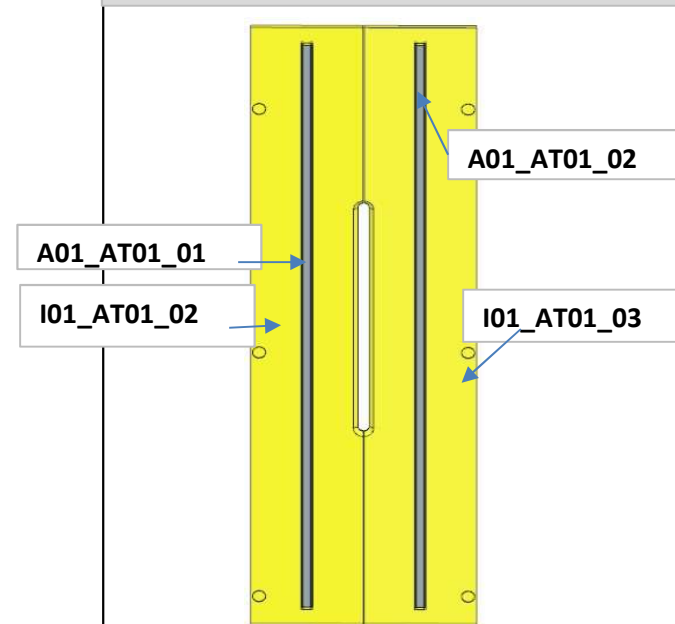

AZ68F

DA MAT. 233

REV. 29-04-2024

LOCALE	CODICE	DESCRIZIONE COMPONENTE	FINITURA	Q.TA	OPERATORE
CABINA ARMATORE	AZ68F-I01_AAL01	ARMADIO DX POPPA OPT	OKOUME' GREZZO	3	Dante

- 1 - L. 537 x H 30,5 x sp 24
- 2 - L. 536 x H 1917 x sp 17
- 3 - L. 88 x 57 x H. 1951

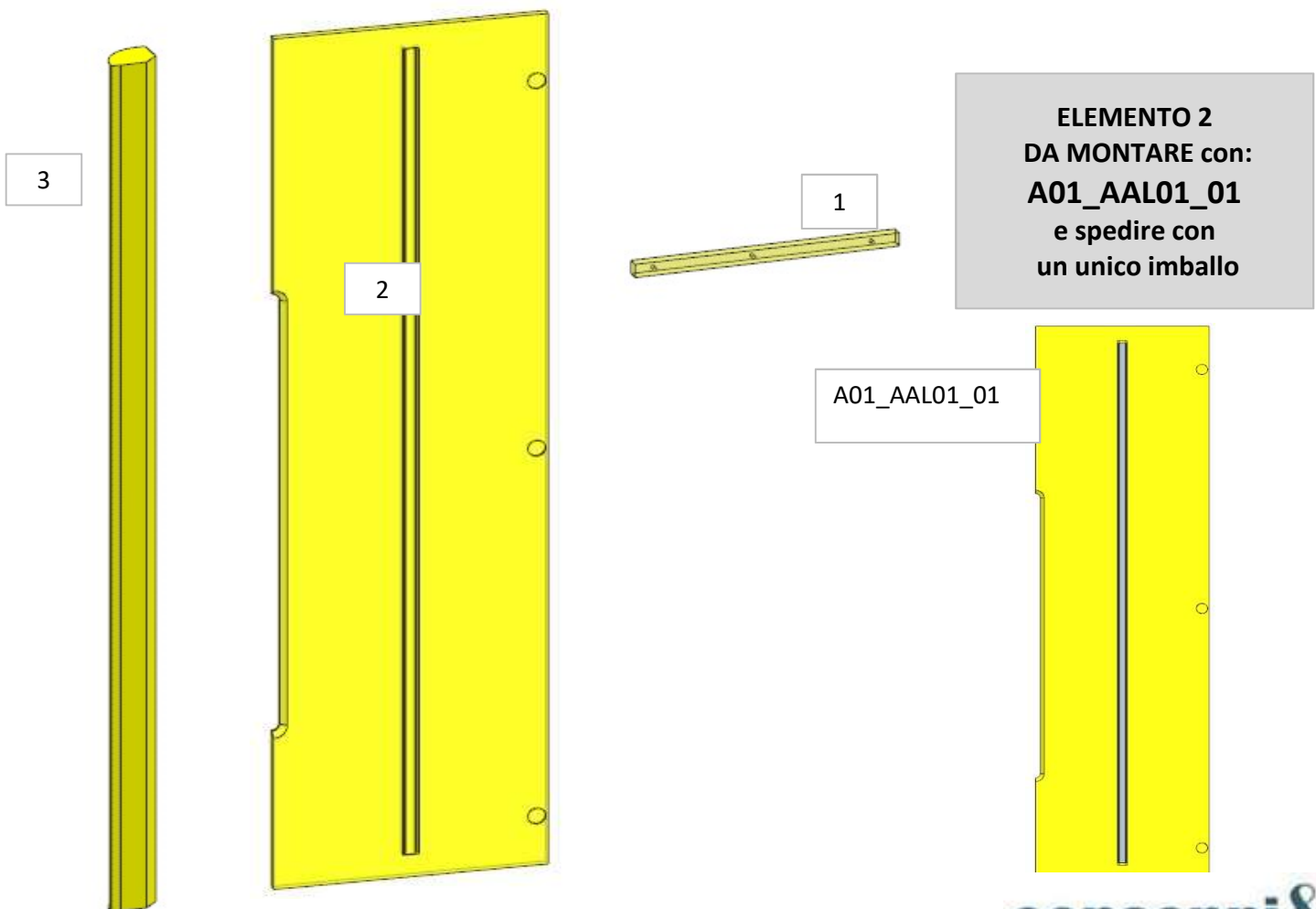

AZ68F

DA MAT. 233

REV. 29-04-2024

LOCALE	CODICE	DESCRIZIONE COMPONENTE	FINITURA	Q.TA	OPERATORE
CABINA ARMATORE	AZ68F-I01_AAM01	STRUTTURA DX ANGOLO POPPA OPT	OKOUME' GREZZO	3	Dante

- 1 - L 401 x H 1954,5 x sp 15
- 2 - L 362 x H 708 x sp 19
- 3 - L 332 x H 485,5 x sp 19

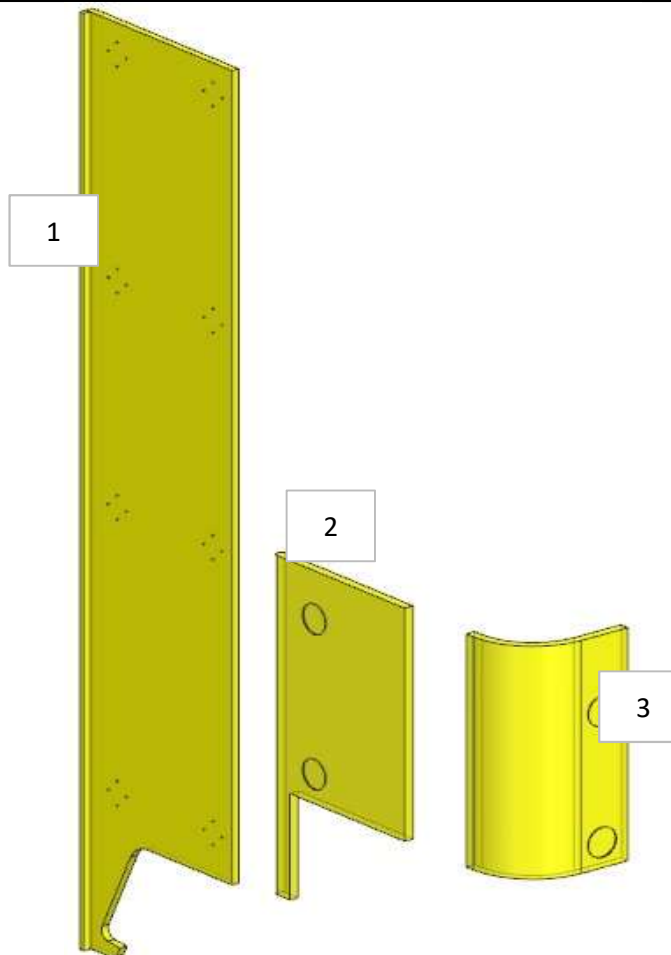

AZ68F

DA MAT. 233

REV. 29-04-2024

LOCALE	CODICE	DESCRIZIONE COMPONENTE	FINITURA	Q.TA	OPERATORE
CABINA ARMATORE	AZ68F-I01_AAO01	STRUTTURA BASSA A MURATA DX OPT	OKOUME' GREZZO	1	Dante

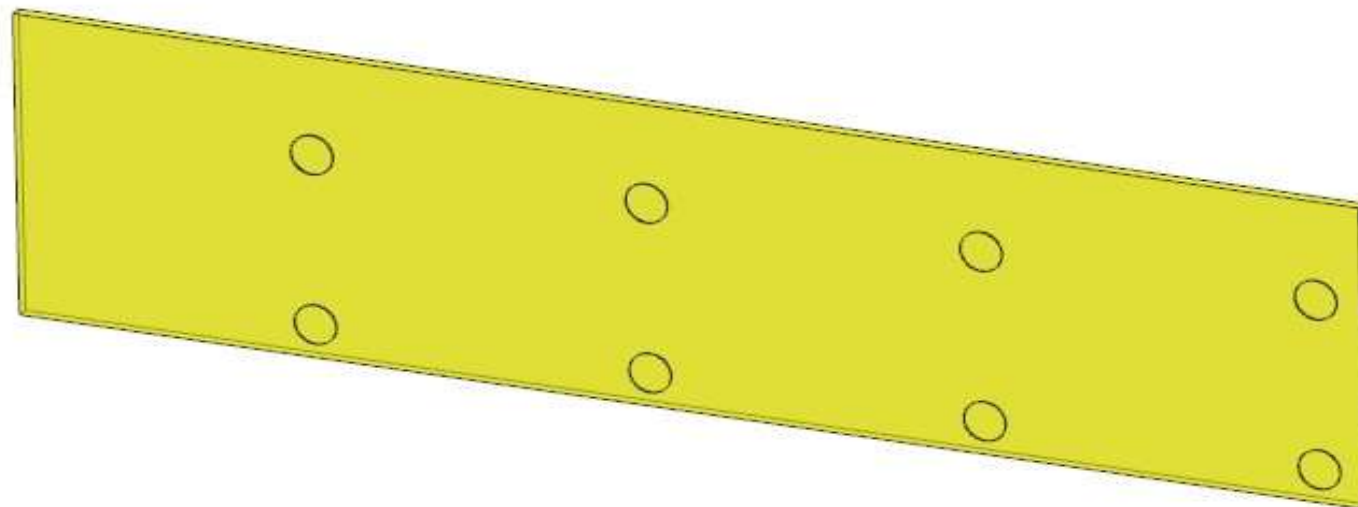

AZ68F

DA MAT. 203

REV. 29-04-2024

LOCALE	CODICE	DESCRIZIONE COMPONENTE	FINITURA	Q.TA	OPERATORE
CABINA ARMATORE	AZ68F-I01_AAR01	COMODINO POPPA OPT	OKOUME' GREZZO	1	Dante

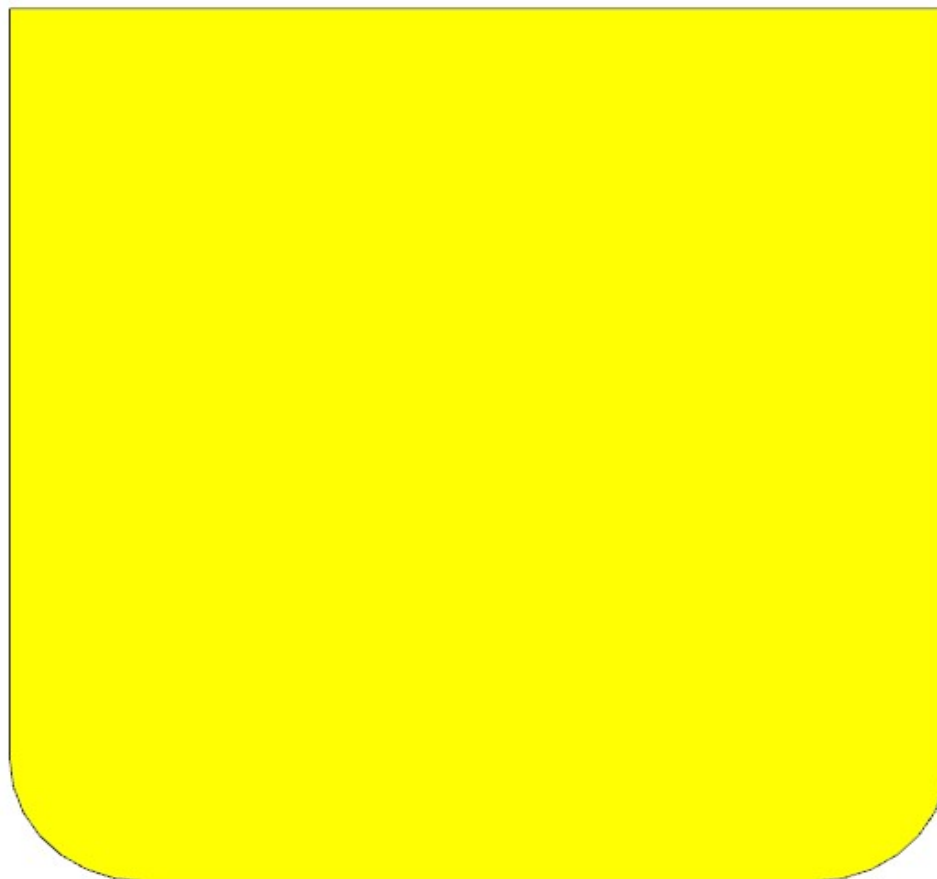

1 - L 488 x H 472 x sp 10